

Graduate Texts in Mathematics

听雨尘心@含藏识

GTM 系列电子书下载



Springer 版权所有

仅供学习，请支持正版书籍

<http://realking1980.bokee.com>

Yves Félix
Stephen Halperin
Jean-Claude Thomas

Rational Homotopy Theory



Springer

Yves Félix
Institut Mathematiques
Universite de Louvain La Neuve
2 chemin du Cyclotron
Louvain-la-Neuve, B-1348
Belgium

Jean-Claude Thomas
Faculte des Sciences
Universite d'Angers
2 bd Lavoisier
Angers 49045
France

Stephen Halperin
College of Computer, Mathematical,
and Physical Science
University of Maryland
3400 A.V. Williams Building
College Park, MD 20742-3281
USA

Editorial Board

S. Axler
Mathematics Department
San Francisco State
University
San Francisco, CA 94132
USA

F.W. Gehring
Mathematics Department
East Hall
University of Michigan
Ann Arbor, MI 48109
USA

K.A. Ribet
Mathematics Department
University of California
at Berkeley
Berkeley, CA 94720-3840
USA

Mathematics Subject Classification (2000): 55-01, 55P62

Library of Congress Cataloging-in-Publication Data

Félix, Y. (Yves)

Rational homotopy theory / Yves Félix, Stephen Halperin, Jean-Claude Thomas
p. cm. — (Graduate texts in mathematics ; 205)

Includes bibliographical references and index.

ISBN 0-387-95068-0 (alk. paper)

I. Homotopy theory I. Halperin, Stephen. II. Thomas, J-C. (Jean-Claude) III. Title.

IV. Series.

QA612.7 .F46 2000

514'24—dc21

00-041913

Printed on acid-free paper.

© 2001 Springer-Verlag New York, Inc.

All rights reserved. This work may not be translated or copied in whole or in part without the written permission of the publisher (Springer-Verlag New York, Inc., 175 Fifth Avenue, New York, NY 10010, USA), except for brief excerpts in connection with reviews or scholarly analysis. Use in connection with any form of information storage and retrieval, electronic adaptation, computer software, or by similar or dissimilar methodology now known or hereafter developed is forbidden. The use of general descriptive names, trade names, trademarks, etc., in this publication, even if the former are not especially identified, is not to be taken as a sign that such names, as understood by the Trade Marks and Merchandise Marks Act, may accordingly be used freely by anyone.

Production managed by Timothy Taylor; manufacturing supervised by Jacqui Ashri.

Camera-ready copy prepared from the authors' PDF files.

Printed and bound by R.R. Donnelley and Sons, Harrisonburg, VA.

Printed in the United States of America.

9 8 7 6 5 4 3 2 1

ISBN 0-387-95068-0

SPIN 10770738

Springer-Verlag New York Berlin Heidelberg

to

AGNES

DANIELLE

JANET

Introduction

Homotopy theory is the study of the invariants and properties of topological spaces X and continuous maps f that depend only on the homotopy type of the space and the homotopy class of the map. (We recall that two continuous maps $f, g : X \rightarrow Y$ are *homotopic* ($f \sim g$) if there is a continuous map $F : X \times I \rightarrow Y$ such that $F(x, 0) = f(x)$ and $F(x, 1) = g(x)$. Two topological spaces X and Y

have the *same homotopy type* if there are continuous maps $X \begin{array}{c} \xrightarrow{f} \\ \xleftarrow{g} \end{array} Y$ such that

$fg \sim id_Y$ and $gf \sim id_X$.) The classical examples of such invariants are the singular homology groups $H_i(X)$ and the homotopy groups $\pi_n(X)$, the latter consisting of the homotopy classes of maps $(S^n, *) \rightarrow (X, x_0)$. Invariants such as these play an essential role in the geometric and analytic behavior of spaces and maps.

The groups $H_i(X)$ and $\pi_n(X)$, $n \geq 2$, are abelian and hence can be rationalized to the vector spaces $H_i(X; \mathbb{Q})$ and $\pi_n(X) \otimes \mathbb{Q}$. Rational homotopy theory begins with the discovery by Sullivan in the 1960's of an underlying geometric construction: simply connected topological spaces and continuous maps between them can themselves be rationalized to topological spaces $X_{\mathbb{Q}}$ and to maps $f_{\mathbb{Q}} : X_{\mathbb{Q}} \rightarrow Y_{\mathbb{Q}}$, such that $H_*(X_{\mathbb{Q}}) = H_*(X; \mathbb{Q})$ and $\pi_*(X_{\mathbb{Q}}) = \pi_*(X) \otimes \mathbb{Q}$. The rational homotopy type of a CW complex X is the homotopy type of $X_{\mathbb{Q}}$ and the rational homotopy class of $f : X \rightarrow Y$ is the homotopy class of $f_{\mathbb{Q}} : X_{\mathbb{Q}} \rightarrow Y_{\mathbb{Q}}$, and rational homotopy theory is then the study of properties that depend only on the rational homotopy type of a space or the rational homotopy class of a map.

Rational homotopy theory has the *disadvantage* of discarding a considerable amount of information. For example, the homotopy groups of the sphere S^2 are non-zero in infinitely many degrees whereas its rational homotopy groups vanish in all degrees above 3. By contrast, rational homotopy theory has the *advantage* of being remarkably computational. For example, there is not even a conjectural description of all the homotopy groups of any simply connected finite CW complex, whereas for many of these the rational groups can be explicitly determined. And while rational homotopy theory is indeed simpler than ordinary homotopy theory, it is exactly this simplicity that makes it possible to address (if not always to solve) a number of fundamental questions.

This is illustrated by two early successes:

- (Vigué-Sullivan [152]) *If M is a simply connected compact riemannian manifold whose rational cohomology algebra requires at least two generators then its free loop space has unbounded homology and hence (Gromoll-Meyer [73]) M has infinitely many geometrically distinct closed geodesics.*
- (Allday-Halperin [3]) *If an r torus acts freely on a homogeneous space G/H (G and H compact Lie groups) then*

$$r \leq \text{rank } G - \text{rank } H ,$$

as well as by the list of open problems in the final section of this monograph.

The computational power of rational homotopy theory is due to the discovery by Quillen [135] and by Sullivan [144] of an explicit algebraic formulation. In each case the rational homotopy type of a topological space is the same as the *isomorphism class* of its algebraic model and the rational homotopy type of a continuous map is the same as the algebraic homotopy class of the corresponding morphism between models. These models make the rational homology and homotopy of a space transparent. They also (in principle, always, and in practice, sometimes) enable the calculation of other homotopy invariants such as the cup product in cohomology, the Whitehead product in homotopy and rational Lusternik-Schirelmann category.

In its initial phase research in rational homotopy theory focused on the identification of rational homotopy invariants in terms of these models. These included the homotopy Lie algebra (the translation of the Whitehead product to the homotopy groups of the loop space ΩX under the isomorphism $\pi_{*+1}(X) \cong \pi_*(\Omega X)$), LS category and cone length.

Since then, however, work has concentrated on the properties of these invariants, and has uncovered some truly remarkable, and previously unsuspected phenomena. For example

- *If X is an n -dimensional simply connected finite CW complex, then either its rational homotopy groups vanish in degrees $\geq 2n$, or else they grow exponentially.*
- *Moreover, in the second case any interval $(k, k + n)$ contains an integer i such that $\pi_i(X) \otimes \mathbb{Q} \neq 0$.*
- *Again in the second case the sum of all the solvable ideals in the homotopy Lie algebra is a finite dimensional ideal R , and*

$$\dim R_{\text{even}} \leq \text{cat } X_{\mathbb{Q}} .$$

- *Again in the second case for all elements $\alpha \in \pi_{\text{even}}(\Omega X) \otimes \mathbb{Q}$ of sufficiently high degree there is some $\beta \in \pi_*(\Omega X) \otimes \mathbb{Q}$ such that the iterated Lie brackets $[\alpha, [\alpha, \dots, [\alpha, \beta] \dots]]$ are all non-zero.*
- *Finally, rational LS category satisfies the product formula*

$$\text{cat}(X_{\mathbb{Q}} \times Y_{\mathbb{Q}}) = \text{cat } X_{\mathbb{Q}} + \text{cat } Y_{\mathbb{Q}} ,$$

in sharp contrast with what happens in the ‘non-rational’ case.

The first bullet divides all simply connected finite CW complexes X into two groups: the *rationally elliptic spaces* whose rational homotopy is finite dimensional, and the *rationally hyperbolic spaces* whose rational homotopy grows exponentially. Moreover, because $H_*(\Omega X; \mathbb{Q})$ is the universal enveloping algebra of the graded Lie algebra $L_X = \pi_*(\Omega X) \otimes \mathbb{Q}$, it follows from the first two bullets

that whether X is rationally elliptic or rationally hyperbolic can be determined from the numbers $b_i = \dim H_i(\Omega X; \mathbb{Q})$, $1 \leq i \leq 3n - 3$, where $n = \dim X$. Rationally elliptic spaces include Lie groups, homogeneous spaces, manifolds supporting a codimension one action and Dupin hypersurfaces (for the last two see [77]). However, the ‘generic’ finite CW complex is rationally hyperbolic.

The theory of Sullivan replaces spaces with algebraic models, and it is extensive calculations and experimentation with these models that has led to much of the progress summarized in these results. More recently the fundamental article of Anick [11] has made it possible to extend these techniques for finite CW complexes to coefficients $\mathbb{Z} \left(\frac{1}{p_1}, \dots, \frac{1}{p_r} \right)$ with only finitely many primes invested, and thereby to obtain analogous results for $H_*(\Omega X; \mathbb{F}_p)$ for large primes p . Moreover, the rational results originally obtained via Sullivan models often suggest possible extensions beyond the rational realm. An example is the ‘depth theorem’ originally proved in [54] via Sullivan models and established in this monograph (§35) topologically for any coefficients. This extension makes it possible to generalize many of the results on loop space homology to completely arbitrary coefficients.

However, for reasons of space and simplicity, in this monograph we have restricted ourselves to rational homotopy theory itself. Thus our monograph has three main objectives:

- *To provide a coherent, self-contained, reasonably complete and usable description of the tools and techniques of rational homotopy theory.*
- *To provide an account of many of the main structural theorems with proofs that are often new and/or considerably simplified from the original versions in the literature.*
- *To illustrate both the use of the technology, and the consequences of the theorems in a rich variety of examples.*

We have written this monograph for graduate students who have already encountered the fundamental group and singular homology, although our hope is that the results described will be accessible to interested mathematicians in other parts of the subject and that our rational homotopy colleagues may also find it useful. To help keep the text more accessible we have adopted a number of simplifying strategies:

- coefficients are usually restricted to fields k of characteristic zero.
- topological spaces are usually restricted to be simply connected.
- Sullivan models for spaces (and their properties) are derived first and only then extended to the more general case of fibrations, rather than being deduced from the latter as a special case.
- complex diagrams and proofs by diagram chase are almost always avoided.

Of course this has meant, in particular, that theorems and technology are not always established in the greatest possible generality, but the resulting saving in technical complexity is considerable.

It should also be emphasized that this is a monograph about topological spaces. This is important, because the models themselves at the core of the subject are strictly algebraic and indeed we have been careful to define them and establish their properties in purely algebraic terms. The reader who needs the machinery for application in other contexts (for instance local commutative algebra) will find it presented here. However the examples and applications throughout are drawn largely from topology, and we have not hesitated to use geometric constructions and techniques when this seemed a simpler and more intuitive approach.

The algebraic models are, however, at the heart of the material we are presenting. They are all graded objects with a *differential* as well as an algebraic structure (algebra, Lie algebra, module, . . .), and this reflects an understanding that emerged during the 1960's. Previously objects with a differential had often been thought of as merely a mechanism to compute homology; we now know that they carry a homotopy theory which is much richer than the homology. For example, if X is a simply connected CW complex of finite type then the work of Adams [1] shows that the homotopy type of the cochain algebra $C^*(X)$ is sufficient to calculate the loop space homology $H_*(\Omega X)$ which, on the other hand, cannot be computed from the cohomology algebra $H^*(X)$. This algebraic homotopy theory is introduced in [134] and studied extensively in [20].

In this monograph there are three differential graded categories that are important:

- (i) modules over a differential graded algebra (dga), (R, d) .
- (ii) commutative cochain algebras.
- (iii) differential graded Lie algebras (dgl's).

In each case both the algebraic structure and the differential carry information, and in each case there is a fundamental modelling construction which associates to an object A in the category a morphism

$$\varphi : M \rightarrow A$$

such that $H(\varphi)$ is an isomorphism (φ is called a *quasi-isomorphism*) and such that the algebraic structure in M is, in some sense "free".

These models (the cofibrant objects of [134]) are the exact analogue of a free resolution of an arbitrary module over a ring. In our three cases above we find, respectively:

- (i) A *semi-free resolution* of a module over (R, d) which is, in particular a complex of free R -modules.

- (ii) A *Sullivan model* of a commutative cochain algebra which is a quasi-isomorphism from a commutative cochain algebra that, in particular, is free as a commutative graded algebra. (These cochain algebras are called *Sullivan algebras*.)
- (iii) A *free Lie model* of a dgl, which is a quasi-isomorphism from a dgl that is free as a graded Lie algebra.

These models are the main algebraic tools of the subject.

The combination of this technology with its application to topological spaces constitutes a formidable body of material. To assist the reader in dealing with this we have divided the monograph into forty sections grouped into six Parts. Each section presents a single aspect of the subject organized into a number of distinct topics, and described in an introduction at the start of the section. The table of contents lists both the titles of the sections and of the individual topics within them. Reading through the table of contents and scanning the introductions to the sections should give the reader an excellent idea of the contents.

Here we present an overview of the six Parts, indicating some of the highlights and the role of each Part within the book.

Part I: Homotopy Theory, Resolutions for Fibrations and P -local Spaces.

This Part is a self-contained short course in homotopy theory. In particular, §0 is merely a summary of definitions and notation from general topology, while §3 is the analogue for (graded) algebra. The text proper begins with the basic geometric objects, CW complexes and fibrations in §1 and §2, and culminates with the rationalization in §9 of a topological space. Since CW complexes and fibrations are often absent from an introductory course in algebraic topology we present their basic properties for the convenience of the reader. In particular, we construct a CW model for any topological space and establish Whitehead's homotopy lifting theorem, since this is the exact geometric analogue, and the motivating example, for the algebraic models referred to above.

Then, in §6, we introduce the first of these algebraic models: the semifree resolution of a module over a differential graded algebra. These resolutions are of key importance throughout the text. Now modules over a dga arise naturally in topology in at least two contexts:

- If $f : X \rightarrow Y$ is a continuous map then the singular cochain algebra $C^*(X)$ is a module over $C^*(Y)$ via $C^*(f)$.
- If $X \times G \rightarrow X$ is the action of a topological monoid then the singular chains $C_*(X)$ are a module over the chain algebra $C_*(G)$.

In §7 we consider the first case when f is a fibration, and use a semifree resolution to compute the cohomology of the fibre (when Y is simply connected

with homology of finite type). In §8 we consider the second case when the action is that of a principal G -fibration $X \rightarrow Y$ and use a semifree resolution to compute $H_*(Y)$. Both these results are due essentially to J.C. Moore.

The second result turns out to give an easy, fast and spectral-sequence-free proof of the Whitehead-Serre theorem that for a continuous map $f : X \rightarrow Y$ between simply connected spaces and for $\mathbb{k} \subset \mathbb{Q}$, $H_*(f; \mathbb{k})$ is an isomorphism if and only if $\pi_*(f) \otimes \mathbb{k}$ is an isomorphism. We have therefore included this as an interesting application, especially as the theorem itself is fundamental to the rationalization of spaces constructed in §9.

Aside from these results it is in Part I that we establish the notation and conventions that will be used throughout (particularly in §0–§5) and state the theorems in homotopy theory we will need to quote. Since it turned out that with the definitions and statements in place the proofs could also be included at very little additional cost in space, we indulged ourselves (and perhaps the reader) and included these as well.

Part II: Sullivan Models

This Part is the core of the monograph, in which we identify the rational homotopy theory of simply connected spaces with the homotopy theory of commutative cochain algebras. This occurs in three steps:

- *The construction in §10 of Sullivan's functor from topological spaces X to commutative cochain algebras $A_{PL}(X)$, which satisfies $C^*(X) \simeq A_{PL}(X)$.*
- *The construction in §12 of the Sullivan model*

$$(\Lambda V, d) \xrightarrow{\cong} (A, d)$$

for any commutative cochain algebra satisfying $H^0(A, d) = \mathbb{k}$. (Here, following Sullivan ([144]), and the rest of the rational homotopy literature, ΛV denotes the free commutative graded algebra on V .)

- *The construction in §17 of Sullivan's realization functor which converts a Sullivan algebra, $(\Lambda V, d)$, (simply connected and of finite type) into a rational topological space $|\Lambda V, d|$ such that $(\Lambda V, d)$ is a Sullivan model for $A_{PL}(|\Lambda V, d|)$.*

Along the way we show that these functors define bijections:

$$\left\{ \begin{array}{c} \text{rational homotopy types} \\ \text{of spaces} \end{array} \right\} \xleftrightarrow{\cong} \left\{ \begin{array}{c} \text{isomorphism classes of} \\ \text{minimal Sullivan algebras} \end{array} \right\}$$

and

$$\left\{ \begin{array}{c} \text{homotopy classes of} \\ \text{maps between rational spaces} \end{array} \right\} \xleftrightarrow{\cong} \left\{ \begin{array}{c} \text{homotopy classes of} \\ \text{maps between minimal} \\ \text{Sullivan algebras} \end{array} \right\}$$

where we restrict to spaces and cochain algebras that are simply connected with cohomology of finite type.

Sullivan's functor A_{PL} was motivated by the classical commutative cochain algebra $A_{DR}(M)$ of smooth differential forms on a manifold. In §11 we review the construction of $A_{DR}(M)$ and prove Sullivan's result that $A_{DR}(M)$ is quasi-isomorphic to $A_{PL}(M; \mathbb{R})$. This implies (§12) that they have the same Sullivan model.

The rest of Part II is devoted to the technology of Sullivan algebras, and to geometric applications. We construct models of adjunction spaces, identify the generating space V of a Sullivan model with the dual of the rational homotopy groups and identify the quadratic part of the differential with the dual of the Whitehead product. Here the constructions are in §13 but some of the proofs are deferred to §15.

In §14 we construct relative Sullivan algebras and decompose any Sullivan algebra as the tensor product of a minimal and a contractible Sullivan algebra. In §15 we use relative Sullivan algebras to model fibrations and show (applying the result from §7) that the Sullivan fibre of the model is a Sullivan model for the fibre. Finally, in §16 this material is applied to the structure of the homology algebra $H_*(\Omega X; \mathbb{k})$ of the loop space of X .

Part III: Graded Differential Algebra (Continued).

In §3 we were careful to limit ourselves to those algebraic constructions needed in Parts I and II. Now we need more: the bar construction of a cochain algebra, spectral sequences (finally, we held off as long as possible!) and some elementary homological algebra.

Part IV: Lie Models

In Part I we introduced the first of our algebraic categories (modules over a dga), in Part II we focused on commutative cochain algebras and now we introduce and study the third category: differential graded Lie algebras.

In §21 we introduce graded Lie algebras and their universal enveloping algebras and exhibit the two fundamental examples in this monograph: the homotopy Lie algebra $L_X = \pi_*(\Omega X) \otimes \mathbb{k}$ of a simply connected topological space, and the homotopy Lie algebra L of a minimal Sullivan algebra $(\Lambda V, d)$. The latter vector space is defined by $L_k = \text{Hom}(V^{k+1}, \mathbb{k})$ with Lie bracket given by the quadratic part of d . Moreover, if $(\Lambda V, d)$ is the Sullivan model for X then $L_X \cong L$.

In §22 we construct the free Lie models for a dgl, (L, d) . We also construct (in §22 and §23) the classical homotopy equivalences

$$(L, d) \rightsquigarrow C^*(L, d) \quad \text{and} \quad (A, d) \rightsquigarrow \mathcal{L}_{(A, d)}$$

between the categories of dgl's (with $L = L_{\geq 1}$ of finite type) and commutative cochain algebras (with simply connected cohomology of finite type). In particular a Lie model for a *free topological space* X is a free Lie model of $\mathcal{L}_{(\Lambda V, d)}$, where $(\Lambda V, d)$ is a Sullivan model for X .

Given a dgl (L, d) that is free as a Lie algebra on generators v_i of degree n_i we show in §24 how to construct a CW complex X with a single $(n_i + 1)$ -cell for each v_i , and whose free Lie model is exactly (L, d) . This provides a much more geometric approach to the passage algebra \rightarrow topology than the realization functor in §17.

Finally, §24 and §25 are devoted to Majewski's theorem [119] that if (L, d) is a free Lie model for X then there is a chain algebra quasi-isomorphism $U(L, d) \xrightarrow{\cong} C_*(\Omega X; \mathbb{k})$ which preserves the diagonals up to dga homotopy.

Part V: Rational Lusternik-Schnirelmann Category

The *LS category*, $\text{cat } X$, of a topological space X is the smallest number m (or infinity) such that X can be covered by $m + 1$ open sets each of which is contractible in X . In particular:

- $\text{cat } X$ is an invariant of the homotopy type of X .
- If $\text{cat } X = m$ then the product of any $m + 1$ cohomology classes of X is zero.
- If X is a CW complex then $\text{cat } X \leq \dim X$ but the inequality may be strict: indeed for the wedge of spheres $X = \bigvee_{i=1}^{\infty} S^i$ we have $\dim X = \infty$ and $\text{cat } X = 1$.

The *rational LS category*, $\text{cat}_0 X$, of X is the LS category of a rational CW complex in the rational homotopy type of X .

Part V begins with the presentation in §27 of the main properties of LS category for 'ordinary' topological spaces. We have included this material here for the convenience of the reader and because, to our knowledge, much of it is not available outside the original articles scattered through the research literature.

We then turn to rational LS category (§28) and its calculation in terms of Sullivan models (§29). A key point is the Mapping Theorem: *Given a continuous map $f : X \rightarrow Y$ between simply connected spaces, then*

$$\pi_*(f) \otimes \mathbb{Q} \text{ injective} \Rightarrow \text{cat}_0 X \leq \text{cat}_0 Y .$$

In particular, the Postnikov fibres in a Postnikov decomposition of a simply connected finite CW complex all have finite rational LS category. (The integral analogue is totally false!).

A second key result is Hess' theorem ($\text{Mcat} = \text{cat}$), which is the main step in the proof of the product formula $\text{cat } X_{\mathbb{Q}} \times Y_{\mathbb{Q}} = \text{cat } X_{\mathbb{Q}} + \text{cat } Y_{\mathbb{Q}}$ in §30. Finally, in §31 we prove a beautiful theorem of Jessup which gives circumstances under which the rational LS category of a fibre must be strictly less than that of the total space of a fibration. The " α, β " theorem described at the start of this introduction is an immediate corollary.

Part VI: The Rational Dichotomy: Elliptic and Hyperbolic Spaces AND Other Applications

In this Part we use rational homotopy theory to derive the results referred to at the start of this introduction (and others) on the structure of $H_*(\Omega X; \mathbb{k})$, when X is a simply connected finite CW complex. These are outlined in the introductions to the sections, and we leave it to the reader to check there, rather than repeating them here.

As the overview above makes evident, this monograph makes no pretense of being a complete account of rational homotopy theory, and indeed important aspects have been omitted. For example we do not treat the iterated integrals approach of Chen ([37], [79], [145]) and therefore have not been able to include the deep applications to algebraic geometry of Hain and others (e.g. [80], [81], [101]). Equivariant rational homotopy theory as developed by Triantafyllou and others ([151]) is another omission, as is any serious effort to treat the non-simply connected case, even though at least nilpotent spaces are covered by Sullivan's original theory. We have not described the Sullivan-Haefliger model ([144], [78]) for the section space of a fibration even in the simpler case of mapping space, except for the simple example of the free loop space X^{S^1} , nor have we included the Sullivan-Barge classification ([144], [18]) of closed manifolds up to rational homotopy type. And we have not given Lemaire's construction [108] of a finite CW complex whose homotopy Lie algebra is not finitely generated as a Lie algebra.

Moreover, this monograph does not pursue the connections outside or beyond rational homotopy theory. Such connections include the algebraic homotopy theory developed by Baues [20] following Quillen's homotopical algebra [134]. There is no mention in the text (except in the problems at the end) of Anick's extension of the theory to coefficients with only finitely many primes inverted ([11]) and its application to loop space homology, and there is equally no mention of how the results in Part VI generalize to arbitrary coefficients [56]. And finally, we have not dealt with the interaction with the homological study of local commutative rings [14] that has been so significantly exploited by Avramov and others.

We regret that limitations of time and energy (as well as our publisher's insistence on limiting the number of pages!) have made it necessary simply to refer the reader to the literature for these important aspects of the subject, in the hope that what is presented here will make that task an easier one.

In the last twenty five years a number of monographs have appeared that presented various parts of rational homotopy theory. These include *Algèbres Connexes et Homologie des Espaces de Lacets* by Lemaire [109], *On PL de Rham Theory and Rational Homotopy Type* by Bousfield and Gugenheim ([30]), *Théorie Homotopique des Formes Différentielles* by Lehmann ([107]), *Rational Homotopy Theory and Differential Forms* by Griffiths and Morgan ([72]), *Homotopie Rationnelle: Modèles de Chen, Quillen, Sullivan* by Tanré ([145]), *Lectures on Minimal Models* by Halperin [82], *La Dichotomie Elliptique – Hyperbolique en Homotopie Rationnelle* by Félix ([50]), and *Homotopy Theory and Models*

by Aubry ([12]). Our hope is that the present work will complement the real contribution these make to the subject.

This monograph brings together the work of many researchers, accomplished as a co-operative effort for the most part over the last thirty years. A clear account of this history is provided in [91], and we would like merely to indicate here a few of the high points. First and foremost we want to stress our individual and collective appreciation to Daniel Lehmann, who led the development of the rational homotopy group at Lille that provided the milieu in which all three of us became involved in the subject. Secondly, we want to emphasize the importance of the memoir [109] by Lemaire and of the article [21] by Baues and Lemaire which have formed the foundation for the use of Lie models.

In this context the mini-conference held at Louvain in 1979 played a key role. It brought together the two approaches (Lie and Sullivan) and crystalized the questions around LS category that proved essential in subsequent work. Another mini-conference in Bonn in 1981 (organized jointly by Baues and the second author) led to a trip to Sofia to meet Avramov and the intensification of the infusion into rational homotopy of the intuition from local algebra begun by Anick, Avramov, Löffwall and Roos.

This monograph was conceived of in 1992 and in the intervening eight years we have benefited from the advice and suggestions of countless colleagues and students. It is a particular pleasure to acknowledge the contributions of Cornea, Dupont, Hess, Jessup, Lambrechts and Murillo, who have all worked with us as students or postdocs and have all beaten problems we could not solve. We also wish to thank Peter Bubenik whose careful reading uncovered an unbelievable number of mistakes, both typographical and mathematical.

The actual writing and rewriting have been a team effort accomplished by the three of us working together in intensive sessions at sites that rotated through the campuses at which we have held faculty positions: the Université Catholique de Louvain (Felix), the University of Toronto and the University of Maryland (Halperin) and the Université de Lille 1 and the Université d'Angers (Thomas). The Fields Institute for Research in Mathematical Sciences in Toronto provided us with a common home during the spring of 1996, and the Centre International pour Mathématiques Pures et Appliquées, hosted and organized a two week summer school at Bréil where we presented a first version of the text. Our granting agencies (Centre National de Recherche Scientifique, FNRS, National Sciences and Engineering Research Council of Canada, North Atlantic Treaty Organization) all provided essential financial support. To all of these organizations we express our appreciation.

Above all, however, we wish to express our deep gratitude and appreciation to Lucile Lo, who converted thousands of pages of handwritten manuscript to beautifully formatted final product with a speed, accuracy, intelligence and good humor that are unparalleled in our collective experience.

And finally, we wish to express our appreciation to our families who have lived through this experience, and most especially to Agnes, Danielle and Janet for their constant nurturing and support, and to whom we gratefully dedicate this book.

Yves Felix
Steve Halperin
Jean-Claude Thomas

Contents

Introduction	vii
Table of Examples	xxvii
I Homotopy Theory, Resolutions for Fibrations, and P-local Spaces	
0 Topological spaces	1
1 CW complexes, homotopy groups and cofibrations	4
(a) CW complexes	4
(b) Homotopy groups	10
(c) Weak homotopy type	12
(d) Cofibrations and NDR pairs	15
(e) Adjunction spaces	18
(f) Cones, suspensions, joins and smashes	20
2 Fibrations and topological monoids	23
(a) Fibrations	24
(b) Topological monoids and G -fibrations	28
(c) The homotopy fibre and the holonomy action	30
(d) Fibre bundles and principal bundles	32
(e) Associated bundles, classifying spaces, the Borel construction and the holonomy fibration	36
3 Graded (differential) algebra	40
(a) Graded modules and complexes	40
(b) Graded algebras	43
(c) Differential graded algebras	46
(d) Graded coalgebras	47
(e) When \mathbb{k} is a field	48
4 Singular chains, homology and Eilenberg-MacLane spaces	51
(a) Basic definitions, (normalized) singular chains.	52
(b) Topological products, tensor products and the dgc, $C_*(X; \mathbb{k})$	53
(c) Pairs, excision, homotopy and the Hurewicz homomorphism	56
(d) Weak homotopy equivalences	58
(e) Cellular homology and the Hurewicz theorem	59
(f) Eilenberg-MacLane spaces	62
5 The cochain algebra $C^*(X; \mathbb{k})$	65

6	(R, d)-modules and semifree resolutions	68
	(a) Semifree models	68
	(b) Quasi-isomorphism theorems	72
7	Semifree cochain models of a fibration	77
8	Semifree chain models of a G-fibration	88
	(a) The chain algebra of a topological monoid	88
	(b) Semifree chain models	89
	(c) The quasi-isomorphism theorem	92
	(d) The Whitehead-Serre theorem	94
9	\mathcal{P}-local and rational spaces	102
	(a) \mathcal{P} -local spaces	102
	(b) Localization	107
	(c) Rational homotopy type	110
 II Sullivan Models		
10	Commutative cochain algebras for spaces and simplicial sets	115
	(a) Simplicial sets and simplicial cochain algebras	116
	(b) The construction of $A(K)$	118
	(c) The simplicial commutative cochain algebra A_{PL} , and $A_{PL}(X)$	121
	(d) The simplicial cochain algebra C_{PL} , and the main theorem	124
	(e) Integration and the de Rham theorem	128
11	Smooth Differential Forms	131
	(a) Smooth manifolds	131
	(b) Smooth differential forms	132
	(c) Smooth singular simplices	133
	(b) (d) The weak equivalence $A_{DR}(M) \simeq A_{PL}(M; \mathbb{R})$	134
12	Sullivan models	138
	(a) Sullivan algebras and models: constructions and examples	140
	(b) Homotopy in Sullivan algebras	148
	(c) Quasi-isomorphisms, Sullivan representatives, uniqueness of minimal models and formal spaces	152
	(d) Computational examples	156
	(e) Differential forms and geometric examples	160
13	Adjunction spaces, homotopy groups and Whitehead products	165
	(a) Morphisms and quasi-isomorphisms	166
	(b) Adjunction spaces	168
	(c) Homotopy groups	171
	(d) Cell attachments	173

- (e) Whitehead product and the quadratic part of the differential . . . 175
- 14 Relative Sullivan algebras** **181**
 - (a) The semifree property, existence of models and homotopy 182
 - (b) Minimal Sullivan models 186
- 15 Fibrations, homotopy groups and Lie group actions** **195**
 - (a) Models of fibrations 195
 - (b) Loops on spheres, Eilenberg-MacLane spaces and spherical fibrations 200
 - (c) Pullbacks and maps of fibrations 203
 - (d) Homotopy groups 208
 - (e) The long exact homotopy sequence 213
 - (f) Principal bundles, homogeneous spaces and Lie group actions . . . 216
- 16 The loop space homology algebra** **223**
 - (a) The loop space homology algebra 224
 - (b) The minimal Sullivan model of the path space fibration 226
 - (c) The rational product decomposition of ΩX 228
 - (d) The primitive subspace of $H_*(\Omega X; \mathbb{k})$ 230
 - (e) Whitehead products, commutators and the algebra structure of $H_*(\Omega X; \mathbb{k})$ 232
- 17 Spatial realization** **237**
 - (a) The Milnor realization of a simplicial set 238
 - (b) Products and fibre bundles 243
 - (c) The Sullivan realization of a commutative cochain algebra 247
 - (d) The spatial realization of a Sullivan algebra 249
 - (e) Morphisms and continuous maps 255
 - (f) Integration, chain complexes and products 256

III Graded Differential Algebra (continued)

- 18 Spectral sequences** **260**
 - (a) Bigraded modules and spectral sequences 260
 - (b) Filtered differential modules 261
 - (c) Convergence 263
 - (d) Tensor products and extra structure 265
- 19 The bar and cobar constructions** **268**
- 20 Projective resolutions of graded modules** **273**
 - (a) Projective resolutions 273
 - (b) Graded Ext and Tor 275
 - (c) Projective dimension 278
 - (d) Semifree resolutions 278

IV Lie Models

21 Graded (differential) Lie algebras and Hopf algebras	283
(a) Universal enveloping algebras	285
(b) Graded Hopf algebras	288
(c) Free graded Lie algebras	289
(d) The homotopy Lie algebra of a topological space	292
(e) The homotopy Lie algebra of a minimal Sullivan algebra	294
(f) Differential graded Lie algebras and differential graded Hopf algebras	296
22 The Quillen functors C_* and \mathcal{L}	299
(a) Graded coalgebras	299
(b) The construction of $C_*(L)$ and of $C_*(L; M)$	301
(c) The properties of $C_*(L; UL)$	302
(d) The quasi-isomorphism $C_*(L) \xrightarrow{\cong} BUL$	305
(e) The construction $\mathcal{L}(C, d)$	306
(f) Free Lie models	309
23 The commutative cochain algebra, $C^*(L, d_L)$	313
(a) The constructions $C^*(L, d_L)$, and $\mathcal{L}_{(A, d)}$	313
(b) The homotopy Lie algebra and the Milnor-Moore spectral sequence	317
(c) Cohomology with coefficients	319
24 Lie models for topological spaces and CW complexes	322
(a) Free Lie models of topological spaces	324
(b) Homotopy and homology in a Lie model	325
(c) Suspensions and wedges of spheres	326
(d) Lie models for adjunction spaces	328
(e) CW complexes and chain Lie algebras	331
(f) Examples	331
(g) Lie model for a homotopy fibre	334
25 Chain Lie algebras and topological groups	337
(a) The topological group, $ \Gamma L $	337
(b) The principal fibre bundle,	338
(c) $ \Gamma L $ as a model for the topological monoid, ΩX	340
(d) Morphisms of chain Lie algebras and the holonomy action	341
26 The dg Hopf algebra $C_*(\Omega X)$	343
(a) Dga homotopy	344
(b) The dg Hopf algebra $C_*(\Omega X)$ and the statement of the theorem .	346
(c) The chain algebra quasi-isomorphism $\theta : (UL_V, d)$	347
(d) The proof of Theorem 26.5	349

V Rational Lusternik Schnirelmann Category

27 Lusternik-Schnirelmann category 351

- (a) LS category of spaces and maps 352
- (b) Ganea’s fibre-cofibre construction 355
- (c) Ganea spaces and LS category 357
- (d) Cone-length and LS category: Ganea’s theorem 359
- (e) Cone-length and LS category: Cornea’s theorem 361
- (f) Cup-length, $c(X; \mathbb{k})$ and Toomer’s invariant, $e(X; \mathbb{k})$ 366

28 Rational LS category and rational cone-length 370

- (a) Rational LS category 371
- (b) Rational cone-length 372
- (c) The mapping theorem 375
- (d) Gottlieb groups 377

29 LS category of Sullivan algebras 381

- (a) The rational cone-length of spaces and the product length of models 382
- (b) The LS category of a Sullivan algebra 384
- (c) The mapping theorem for Sullivan algebras 389
- (d) Gottlieb elements 392
- (e) Hess’ theorem 393
- (f) The model of $(\Lambda V, d) \rightarrow (\Lambda V/\Lambda^{>m}V, d)$ 396
- (g) The Milnor-Moore spectral sequence and Ginsburg’s theorem . . . 399
- (h) The invariants $mcat$ and e for $(\Lambda V, d)$ -modules 401

30 Rational LS category of products and fibrations 406

- (a) Rational LS category of products 406
- (b) Rational LS category of fibrations 408
- (c) The mapping theorem for a fibre inclusion 411

31 The homotopy Lie algebra and the holonomy representation 415

- (a) The holonomy representation for a Sullivan model 418
- (b) Local nilpotence and local conilpotence 420
- (c) Jessup’s theorem 424
- (d) Proof of Jessup’s theorem 425
- (e) Examples 430
- (f) Iterated Lie brackets 432

**VI The Rational Dichotomy:
Elliptic and Hyperbolic Spaces
and
Other Applications**

32 Elliptic spaces 434

(a) Pure Sullivan algebras	435
(b) Characterization of elliptic Sullivan algebras	438
(c) Exponents and formal dimension	441
(d) Euler-Poincaré characteristic	444
(e) Rationally elliptic topological spaces	447
(f) Decomposability of the loop spaces of rationally elliptic spaces . .	449
33 Growth of Rational Homotopy Groups	452
(a) Exponential growth of rational homotopy groups	453
(b) Spaces whose rational homology is finite dimensional	455
(c) Loop space homology	458
34 The Hochschild-Serre spectral sequence	464
(a) Hom, Ext, tensor and Tor for UL -modules	465
(b) The Hochschild-Serre spectral sequence	467
(c) Coefficients in UL	469
35 Grade and depth for fibres and loop spaces	474
(a) Complexes of finite length	475
(b) ΩY -spaces and $C_*(\Omega Y)$ -modules	476
(c) The Milnor resolution of \mathbb{k}	478
(d) The grade theorem for a homotopy fibre	481
(e) The depth of $H_*(\Omega X)$	486
(f) The depth of UL	486
(g) The depth theorem for Sullivan algebras	487
36 Lie algebras of finite depth	492
(a) Depth and grade	493
(b) Solvable Lie algebras and the radical	495
(c) Noetherian enveloping algebras	496
(d) Locally nilpotent elements	497
(e) Examples	497
37 Cell Attachments	501
(a) The homology of the homotopy fibre, $X \times_Y PY$	502
(b) Whitehead products and G -fibrations	502
(c) Inert element	503
(d) The homotopy Lie algebra of a spherical 2-cone	505
(e) Presentations of graded Lie algebras	507
(f) The Löfwall-Roos example	509
38 Poincaré Duality	511
(b) Properties of Poincaré duality	511
(b) Elliptic spaces	512
(c) LS category	513
(d) Inert elements	513

Rational Homotopy Theory	xxv
39 Seventeen Open Problems	516
References	521
Index	531

Table of Examples

§1. CW complexes, homotopy groups and cofibrations

- (a)
 1. Complex projective space
 2. Wedges
 3. Products
 4. Quotients and suspensions
 5. Cubes and spheres
 6. Adjunction spaces
 7. Mapping cylinders

§2. Fibrations and topological monoids

- (a)
 1. Products
 2. Covering projections
 3. Fibre products and pullbacks
- (b)
 1. Path space fibrations

§3. Graded (differential) algebra

- (b)
 1. Change of algebra
 2. Free modules
 3. Tensor product of graded algebras
 4. Tensor algebra
 5. Commutative graded algebras
 6. Free commutative graded algebras
- (c)
 1. $\text{Hom}_R(M, N)$
 2. Tensor products
 3. Direct products
 4. Fibre products

§9. \mathcal{P} -local and rational spaces

- (a)
 1. The infinite telescope S_p^n
- (b)
 1. Cellular localization

§10. Commutative cochain algebras for spaces and simplicial set

- (c)
 1. $A_{PL}(pt)$

§11. Smooth differential forms

- (a) Smooth manifolds:
 1. \mathbb{R}^n
 2. Open subsets
 3. Products

§12. Sullivan models

- (a)
 1. The spheres, S^k
 2. Products of topological spaces
 3. H -spaces
 4. A cochain algebra $(\Lambda V, d)$ that is not a Sullivan algebra
 5. $(\Lambda V, d)$, $\text{Im } d \subset \Lambda^+ V \cdot \Lambda^+ V$
 6. Topological spaces with finite homology admit finite dimensional commutative models
 7. $(\Lambda(a, b, x, y, z), d)$, $da = db = 0$, $dx = a^2$, $dy = ab$, $dz = b^2$
- (b)
 1. Null homotopic morphisms into $(A, 0)$ are constant
- (c)
 1. Wedges
- (d)
 1. $(\Lambda V, d) = \Lambda(x, y, z; dx = dy = 0, dz = xy)$, $\deg x = 3$, $\deg y = 5$
 2. Automorphisms of the model of $S^3 \times S^3 \times S^5 \times S^6$
 3. $(\Lambda V, d) = \Lambda(a, x, b; da = dx = 0, db = ax)$, $\deg a = 2$, $\deg x = 3$
 4. $\Lambda(x, y, z, u; dx = dy = dz = 0, du = x^m + y^m - z^m)$, $\deg x = \deg y = \deg z = 2$
 5. Two morphisms that homotopy commute, but are not homotopic to commuting morphisms
 6. Sullivan algebras homogeneous with respect to wordlength
 7. Sullivan models for cochain algebras $(H, 0)$ with trivial multiplication
- (e)
 1. The cochain algebra $A_{DR}(G)^G$ of right invariant forms on G , and its minimal model
 2. Nilmanifolds
 3. Symmetric spaces are formal
 4. Compact Kähler manifolds are formal
 5. Symplectic manifolds need not be formal

§13. Adjunction spaces, homotopy groups and Whitehead products

- (e)
 1. The even spheres S^{2n}
 2. $S^3 \vee S^3 \cup_f (D_0^8 \amalg D_1^8)$

§14. Relative Sullivan algebras

- (b)
 1. The acyclic closure $(B \otimes \Lambda V, d)$
 2. A commutative model for a Sullivan fibre

§15. Fibrations, homotopy groups and Lie group actions

- (b)
 1. The model of the loop space ΩS^k , $k \geq 2$
 2. The model of an Eilenberg-MacLane space
 3. The rational homotopy type of $k(\mathbb{Z}, n)$
 4. Spherical fibrations

- 5. Complex projective spaces
- (c) 1. The free loop space X^{S^1}
- (d) 1. Rational homotopy group of spheres
 - 2. $(\Lambda(e_0, e_1, x), dx = e_0 e_1)$
 - 3. The Quillen plus construction
 - 4. Smooth manifolds and smooth maps
- (f) 1. Homogeneous spaces
 - 2. Borel construction; application to free actions
 - 3. Matrix Lie groups
 - 4. A fibre bundle with fibre $S^3 \times SU(3)$ that is not principal
 - 5. Non-existence of free actions

§16. The loop space homology algebra

- (a) 1. The homology algebra $H_*(\Omega S^{2k+1}; \mathbb{k}), k > 1$
- (e) 1. The homology algebra $H_*(\Omega S^{n+1}; \mathbb{k})$

§17. Spatial realization

- (a) 1. $|\Delta[n]| = \Delta^n$
 - 2. Cones
 - 3. Extendable simplicial sets
- (b) 1. A simplicial construction of the Eilenberg MacLane space $K(\mathbb{k}, 1)$
- (c) 1. Realization of products
 - 2. Contractible Sullivan algebras have contractible realizations

§18. Spectral sequences

- (b) 1. Semifree modules
 - 2. Relative Sullivan algebras
 - 3. The wordlength filtration of a Sullivan algebra
 - 4. Bigradations
- (d) 1. Filtered differential graded algebras

§20. Projective resolutions of graded modules

- (b) 1. The bar construction
- (d) 1. The Eilenberg-Moore spectral sequence

§21. Graded (differential) Lie algebras and Hopf algebras

- 1. Graded algebras
- 2. The adjoint representation
- 3. Derivations
- 4. Products
- 5. The tensor product $A \otimes L$

- (a) 1. Abelian Lie algebras

§22. The commutative cochain algebra $C^*(L, d_L)$

- (a) 1. Graded Lie algebras
 2. Free graded Lie algebras
 3. Minimal Lie models of minimal Sullivan algebras
 4. Sullivan algebras $(\Lambda W, d)$ for which $H^{2k}(\Lambda W, d) = 0$, $1 \leq k < n$
- (b) 1. $C^*(L, d_L)$
 2. Topological spaces X

§24. Lie models for topological spaces and CW complexes.

1. The free Lie model of a sphere
- (c) 1. If $H_+(X; \mathbb{Q})$ is concentrated in odd degrees then D has the rational homotopy type of a wedge of spheres.
- (f) 1. $(\mathbb{L}_V, 0)$ is the minimal Lie model of a wedge of spheres
 2. The coproduct of Lie models is a Lie model for a wedge
 3. The direct sum of Lie models is a Lie model of the product
 4. A Lie model for $S_a^3 \vee S_b^3 \cup_{[\alpha, [\alpha, \beta]_W]_W} D^8$
 5. Lie models for $\mathbb{C}P^\infty$ and $\mathbb{C}P^n$
 6. A Lie model for $(\mathbb{C}P^2 \vee S^3) \cup_{[\alpha, \beta]_W} D^8$
 7. Coformal spaces
 8. Minimal free chain Lie model

§27. Lusternik-Schnirelmann category

- (e) 1. The LS category of the Ganea spaces $P_n X$

§28. Rational LS category and rational cone-length

- (a) 1. $\text{cat}_0 \left(\bigvee_{\alpha} X_{\alpha} \right) = \max_{\alpha} \{ \text{cat}_0(X_{\alpha}) \}$
- (c) 1. Postnikov fibres
 2. Free loop spaces have infinite rational category
- (d) 1. G -spaces
 2. The holonomy fibration
 3. Loop spaces

§29. LS category of Sullivan algebras

- (b) 1. A space X satisfying $c_0 X < e_0 X$
 2. A space X satisfying $e_0 X < \text{cat}_0 X$
 3. A space X satisfying $\text{cat}_0 X < \text{cl}_0 X$
 4. Formal spaces
 5. Coformal spaces

with $V = V^{\text{odd}}$ and \dim

- (c) 1. $e((\Lambda V, d) \otimes (\Lambda W, d)) = e(\Lambda V, d) + e(\Lambda W, d)$
- 2. $\text{cat}_0 X - e_0 X$ can be arbitrary large
- (d) 1. A non-trivial Gottlieb element
- (e) 1. Field extension preserves category
- 2. Rational category of smooth manifolds

§30. Rational LS category of products and fibrations

- (b) 1. The relative Sullivan algebra $(\Lambda(x, y), dy = x^{r+1})$
 $\rightarrow (\Lambda(x, y, u, v), dy = x^{r+1}, dv = u^{n+1} - x)$
- (c) 1. Fibrations with $\text{cat } X = 0$
- 2. Fibrations with $\text{cat } X = 1$
- 3. Fibrations with $\text{cat}_0 X = \max(\text{cat}_0 Y, \text{cat}_0 F)$

§31. The homotopy Lie algebra and the holonomy representation

- (b) 1. The holonomy representation
- 2. The adjoint representation
- (e) 1. The fibration $p : S^{4m+3} \rightarrow \mathbb{H}P^m$
- 2. The fibration associated with $S^3 \vee S^3 \rightarrow S^3$
- 3. Derivations in commutative cochain algebras
- 4. A fibration $X \rightarrow \mathbb{C}P^n$ with fibre S^3 and $\text{cat}_0 X = 2$
- (f) 1. A space X with $e_0 X = 2$ and $\text{cat}_0 X = \infty$

§32. Elliptic spaces

- (b) 1. $\Lambda(a_2, x_3, u_3, b_4, v_5, w_7; da = dx = 0, du = a^2, db = ax, dv = ab - ux, dw = b^2 - vx)$
- 2. Adding variables of high degree
- 3. Algebraic closure of \mathbb{k} is necessary in Proposition 32.3
- 4. n -colourable graphs
- (e) 1. Simply connected finite H -spaces are rationally elliptic
- 2. Simply connected homogeneous spaces G/K are rationally elliptic
- 3. Free torus actions

§33. Growth of rational homotopy groups

- (c) 1. Wedges of spheres
- 2. $X = S^3 \vee S^3$
- 3. $X = S_1^3 \vee S_2^3 \cup_{[\alpha, \beta]_W} D^8$
- 4. $X = T(S^3, S^3, S^3)$
- 5. $X = Y \vee Z$

§34. The Hochschild-Serre spectral sequence

- (a) 1. $\text{Tor}^{UI}(\mathbb{k}, \mathbb{k}) = s(I/[I, I])$
- 2. The representation of L/I in $\text{Tor}_q^{UI}(\mathbb{k}, \mathbb{k})$

§36. Lie algebra of finite depth

- (e)
1. Depth = 0
 2. Free products have depth 1
 3. $X \vee Y$
 4. Products
 5. $X = S_a^3 \vee S_b^3 \cup_{[a[a,b]_w]_w} D^8$
 6. $\mathbb{C}P^\infty / \mathbb{C}P^n$
 7. $e_0(X) = 2$; $\text{cat}_0(X) = \text{depth } L_X = 3$
 8. $L = \text{Der}_{>0} \mathbb{L}_V$, where V is a finite dimensional vector dimension at least 3

Part I

Homotopy Theory, Resolutions for Fibrations, and P-local Spaces

0 Topological spaces

In this section we establish the notation and conventions for topological spaces that will obtain throughout the monograph.

A k -space (not to be confused with the symbol \mathbb{k} used to denote coefficient ring) is a Hausdorff topological space X such that $A \subset X$ is closed if and only if $A \cap C$ is closed in C for all compact subspaces $C \subset X$. If X is any Hausdorff topological space then X_k is the set X equipped with the *associated k -space topology*: A is closed in X_k if and only if $A \cap C$ is closed in C for all compact subspaces C of X . It is easy to see that X_k is a k -space, $X_k \xrightarrow{id} X$ is a continuous bijection and $X = X_k$ if and only if X itself is a k -space. Moreover, all metric spaces are k -spaces. A continuous map $f : X \rightarrow Y$ is *proper* if $f^{-1}(C)$ is compact whenever C is. It is an easy but important observation that: *a proper continuous bijection between k -spaces is a homeomorphism.*

Henceforth in this book we shall restrict attention to k -spaces.

Consistent with this convention we need to modify some (but not all) of the standard topological constructions as follows [44].

- *Subspaces.*

If A is a subset of a k -space X then we assign to A the k -space topology associated with the ‘ordinary’ subspace topology.

- *Products.*

If $\{X_\alpha\}$ is a family of k -spaces we assign to the set theoretic product $\prod_\alpha X_\alpha$ the k -space topology associated to the ordinary product topology. If Z is any k -space then a map $f : Z \rightarrow \prod_\alpha X_\alpha$ is continuous if and only if each ‘component’ $f_\alpha : Z \rightarrow X_\alpha$ is continuous.

Note also that if X is locally compact and Y is a k -space then the k -space topology in $X \times Y$ is just the ordinary topology.

- *Quotients.*

A quotient space Y of X is a surjection $p : X \rightarrow Y$ such that $U \subset Y$ is open if and only if $p^{-1}(U)$ is open. We only consider quotients Y such that Y is Hausdorff and X is a k -space; in this case Y is automatically a k -space. The product $p \times p' : X \times X' \rightarrow Y \times Y'$ of two such quotient maps is itself a quotient map. (This follows easily from a lemma of Whitehead [44] which states that $p \times id : X \times K \rightarrow Y \times K$ is a quotient map if K is locally compact.)

- *Mapping spaces.*

If X and Y are topological spaces then Y^X (as a set) is the set of continuous maps from X to Y . The *compact-open topology* in this set is the topology whose open sets are the arbitrary unions of finite intersections of subsets of the form U^C with U open in Y and C compact in X . As usual we assign to Y^X the k -space topology associated with the compact-open topology. Then for k -spaces

X, Y, Z the *exponential law* asserts that a homeomorphism $Z^{Y \times X} \xrightarrow{\cong} (Z^Y)^X$ is given by $f \mapsto F$, with $F(x)(y) = f(y, x)$. In particular, the evaluation map $Y^X \times X \rightarrow Y, (g, x) \mapsto g(x)$, is continuous.

The following conventions from topology will be used without further reference.

- The *length* of $v \in \mathbb{R}^k$ is denoted by $\|v\|$.
- The *unit interval* $I = [0, 1]$.
- The *unit n -cube* $I^n = I \times \dots \times I \subset \mathbb{R}^n$. Thus the boundary, ∂I^n , consists of the points $x \in I^n$ with some $x_i \in \{0, 1\}$.
- The *n -dimensional disk* $D^n \subset \mathbb{R}^n$ is defined by $D^n = \{x \in \mathbb{R}^n \mid \|x\| \leq 1\}$.
- The *n -dimensional sphere* $S^n \subset \mathbb{R}^{n+1}$ is defined by $S^n = \{x \in \mathbb{R}^{n+1} \mid \|x\| = 1\}$. Thus $S^n = \partial D^{n+1}$ is the boundary of the $(n + 1)$ -disk.
- A *pair of topological spaces*, (X, A) is a space X and a subspace $A \subset X$ (with the k -space topology described above).

A *map of pairs*, $\varphi : (X, A) \rightarrow (Y, B)$ is a continuous map $\varphi_X : X \rightarrow Y$ restricting to $\varphi_A : A \rightarrow B$. If Z is another space then

$$(X, A) \times Z = (X \times Z, A \times Z).$$

- Given continuous maps $X \xrightarrow{f} Y \xleftarrow{g} Z$ the *fibre product* $X \times_Y Z \subset X \times Z$ is the subspace of points (x, z) such that $f(x) = g(z)$. Projection defines a commutative square

$$\begin{array}{ccc} X \times_Y Z & \longrightarrow & Z \\ \downarrow & & \downarrow g \\ X & \xrightarrow{f} & Y \end{array}$$

and any pair of continuous maps $\varphi : W \rightarrow X, \psi : W \rightarrow Z$ such that $f\varphi = g\psi$ defines a continuous map $(\varphi, \psi) : W \rightarrow X \times_Y Z$.

- A *based (or pointed) space* is a pair (X, x_0) ; $x_0 \in X$ is the *basepoint*. A *based map* is a map $\varphi : (X, x_0) \rightarrow (Y, y_0)$.
- The *disjoint union* of spaces X_α is denoted by $\coprod_\alpha X_\alpha$. The *wedge* of based spaces (X_α, x_α) is the based space $\bigvee_\alpha X_\alpha = \coprod_\alpha X_\alpha / \coprod_\alpha \{x_\alpha\}$. Based maps $\varphi : (X, x_0) \rightarrow (Z, z_0)$ and $\psi : (Y, y_0) \rightarrow (Z, z_0)$ define a map $(\varphi, \psi) : X \vee Y \rightarrow Z$.

- Suppose given a pair (Z, B) and a continuous map $f : B \rightarrow X$. We denote by $X \cup_f Z$ the quotient space of $X \amalg Z$ obtained by identifying $b \sim f(b), b \in B$. It is called the *adjunction space* obtained by attaching Z to X along f .
- Given $A \subset X$ the based space $(X/A, [A])$ is obtained by identifying the points of A to a single point $[A]$, and giving X/A the quotient topology. Thus $X/A = * \cup_f X$, where $f : A \rightarrow *$ is the constant map.
- The *suspension*, ΣX , of a based space (X, x_0) is the based space $X \times I / (X \times \{0, 1\} \cup \{x_0\} \times I)$.
- Continuous maps $f, g : X \rightarrow Y$ are *homotopic* ($f \sim g$) if there is a continuous map $F : X \times I \rightarrow Y$ such that $F(x, 0) = f(x)$ and $F(x, 1) = g(x), x \in X$. F is a *homotopy* from f to g . Being homotopic is an equivalence relation; the equivalence class of f is its *homotopy class* and the set of homotopy classes of maps is denoted by $[X, Y]$.
- A *homotopy equivalence* is a continuous map $f : X \rightarrow Y$ such that for some continuous map $g : Y \rightarrow X$ we have $fg \sim id_Y$ and $gf \sim id_X$. In this case we write $f : X \xrightarrow{\cong} Y$ and we say g is a *homotopy inverse* for f . If there is a homotopy equivalence from X to Y then X and Y have the *same homotopy type* and we write $X \simeq Y$. If the constant map $X \rightarrow pt$ is a homotopy equivalence then X is *contractible*.
- A *based homotopy* between $f, g : (X, x_0) \rightarrow (Y, y_0)$ is a continuous map $F : (X, x_0) \times I \rightarrow (Y, y_0)$ such that $F(x, 0) = f(x)$ and $F(x, 1) = g(x)$. This is an equivalence relation and the class of f is its *based homotopy class*. The set of based homotopy classes is denoted by $[(X, x_0), (Y, y_0)]$. A *based homotopy equivalence* is a continuous map $f : (X, x_0) \rightarrow (Y, y_0)$ such that for some continuous map $g : (Y, y_0) \rightarrow (X, x_0)$, fg and gf are, respectively, based homotopic to id_Y and id_X .
- Two continuous maps $f, g : X \rightarrow Y$ which restrict to the same map φ in a subspace $A \subset X$ are *homotopic rel A* if there is a homotopy H from f to g such that $H(a, t) = \varphi(a)$ for all $a \in A, t \in I$; H is a *homotopy rel A* .
- A subspace $A \xrightarrow{i} X$ is a *retract of X* if there is a map $\rho : X \rightarrow A$ (the *retraction*) such that $\rho i = id_A$. It is a *strong deformation retract* if also $i\rho \sim id_X$ rel A .

1 CW complexes, homotopy groups and cofibrations

We begin this monograph by introducing the main objects of study in homotopy theory: CW complexes and their homotopy groups. The topological spaces (manifolds, polyhedra, real algebraic varieties, ...) that arise in geometric contexts are all CW complexes.

Homotopy groups are groups $\pi_n(X)$, $n \geq 1$, defined for any topological space, and abelian for $n \geq 2$. A *weak homotopy equivalence* is a continuous map f such that $\pi_*(f)$ is an isomorphism, and we establish two important results of JHC Whitehead:

- *There is a weak homotopy equivalence from a CW complex to any topological space, and*
- *A continuous map from a CW complex lifts, up to homotopy, through a weak homotopy equivalence.*

It follows that two CW complexes connected by a chain of weak homotopy equivalences have the same homotopy type.

This section is organized into the following topics (We note however that, aside from the definition of suspension, topics (d) – (f) will not be needed until Part V):

- CW complexes.
- Homotopy groups.
- Weak homotopy type.
- Cofibrations and NDR pairs.
- Adjunction spaces.
- Cones, suspensions, joins and smashes.

(a) CW complexes.

Let $f : \coprod_{\alpha} S_{\alpha}^{n-1} \rightarrow X$ be a continuous map from a disjoint union of $(n-1)$ spheres S_{α}^{n-1} to a topological space X . We denote by $Y = X \cup_f (\coprod_{\alpha} D_{\alpha}^n)$ the quotient space obtained from the disjoint union $X \coprod (\coprod_{\alpha} D_{\alpha}^n)$ by identifying $x \in S_{\alpha}^{n-1}$ with $f(x) \in X$. The image e_{α}^n of D_{α}^n in Y is called an *n-cell* and this construction is called *attaching n-cells* to X along an attaching map f . Thus $Y = X \cup (\bigcup_{\alpha} e_{\alpha}^n)$. The map $F_{\alpha}^n : D_{\alpha}^n \rightarrow Y$ is called the *characteristic map* of the n -cell; by definition it restricts to $f : S_{\alpha}^{n-1} \rightarrow X$.

A *filtered space* is a topological space X together with an increasing sequence $X_{-1} \subset X_0 \subset X_1 \subset \dots$ of closed subspaces such that $X = \bigcup_{n \geq -1} X_n$ and X has the weak topology determined by the X_n .

We are now ready to introduce CW complexes, and we do so in the following sequence of basic definitions:

- Let A be a topological space (necessarily a k -space by our convention). A *relative CW complex* is a pair (X, A) in which $X = \bigcup_{n \geq -1} X_n$ is a filtered space, $A = X_{-1}$, and there are specified identifications and maps

$$X_0 = A \amalg \left(\coprod_{\alpha \in \mathcal{I}_0} D_\alpha^0 \right),$$

and

$$f_n : \coprod_{\alpha \in \mathcal{I}_{n+1}} S_\alpha^n \rightarrow X_n, \quad X_{n+1} = X_n \cup_{f_n} \left(\coprod_{\alpha \in \mathcal{I}_{n+1}} D_\alpha^{n+1} \right), \quad n \geq 0.$$

X_n is called the *n -skeleton* of (X, A) . A *CW complex* is a relative CW complex of the form (X, ϕ) .

- If X is a CW complex and $X = X_n$, some n , then X is *n -dimensional* or *finite dimensional*. If X has finitely many n -cells for each n , then X has *finite type*.
- A *based CW complex* is a pair (X, x_0) with X a CW complex and $x_0 \in X_0$.
- A *cellular map* $f : (X, A) \rightarrow (Y, B)$ between relative CW complexes is a continuous map such that $f : X_n \rightarrow Y_n$, $n \geq -1$.
- A *subcomplex* of (X, A) is a pair (Y, A) in which Y is a subspace of X that is a union of A and of cells of X . Note that (Y, A) and (X, Y) are then also relative CW complexes.

We begin with some elementary remarks about the topology of CW complexes. Let (X, A) be a relative CW complex with characteristic maps $F_\alpha : D_\alpha^n \rightarrow X_n$. Then $f : X \rightarrow Z$ is continuous if and only if $f|_A$ and $f \circ F_\alpha^n$ are continuous for all n and α .

Next, if $x_\alpha \in D_\alpha^n - S_\alpha^{n-1}$ we may identify $(D_\alpha^n - \{x_\alpha\}, S_\alpha^{n-1}) = (S_\alpha^{n-1} \times (0, 1], S_\alpha^{n-1} \times \{1\})$. Fix such an x_α for each cell, and write $X_n = X_{n-1} \cup_f (\coprod_\alpha D_\alpha^n)$, where $f = \{f_\alpha\} : \coprod_\alpha S_\alpha^{n-1} \rightarrow X_{n-1}$ is the attaching map. There is then an automatic procedure for extending a subset $O \subset X_{n-1}$ to $V \subset X_n$: set

$$V = O \cup_f \left(\coprod_\alpha f_\alpha^{-1}(O) \times (0, 1] \right).$$

If O is open in X_{n-1} then V is open in X_n . Iterating this procedure ad infinitum produces $U \subset X$ such that each $U \cap X_k$ is open; i.e., U is open in X . Clearly $U \cap X_n = O$, and we call U the *canonical extension of O away from the x_α* .

Proposition 1.1 *Let (X, A) be a relative CW complex. Then*

- (i) *X is Hausdorff, and hence automatically a k -space.*
- (ii) *Every compact subset of X is contained in the union of A and finitely many cells.*
- (iii) *If $A = \emptyset$ then X has a universal covering space.*
- (iv) *If A is normal so is X .*

proof: (i) If $x, y \in X_n - X_{n-1}$ ($n \geq -1$) then there are disjoint open neighbourhoods $O(x), O(y) \subset X_n - X_{n-1}$. The canonical extensions to open sets $U(x), U(y) \subset X$ are disjoint. The general case is proved in the same way.

(ii) Let $C \subset X$ be compact and choose $x_\alpha \in F_\alpha(D_\alpha^n - S_\alpha^{n-1})$ so $x_\alpha \in C$ if $C \cap F_\alpha(D_\alpha^n - S_\alpha^{n-1}) \neq \emptyset$. For each β extend $F_\beta(D_\beta^n - S_\beta^{n-1}) \subset X_n$ to an open set $U_\beta \subset X$, as described above and in the same way extend $A = X_{-1}$ to an open set U_A . This defines an open cover of X and x_α is in U_α and in no other U_β . Since C is compact $C \subset U_A \cup U_{\alpha_1} \cup \dots \cup U_{\alpha_k}$. It follows that only

$x_{\alpha_1}, \dots, x_{\alpha_k}$ are in C , i.e., $C \subset A \cup \bigcup_1^k F_{\alpha_i}(D_{\alpha_i}^n)$.

(iii) For each n -cell, $F_\alpha(D_\alpha^n - S_\alpha^{n-1})$ is an open subspace of $X_n - X_{n-1}$. Extend this to an open subset U_α^n of X away from the origins of the other cells. It is easy to see that any loop in U_α^n is homotopic to the constant loop, and that the U_α^n cover X . Hence the standard construction [68] provides a universal cover.

(iv) Suppose C and C' are disjoint closed subspaces of X . We define a continuous function $h : X \rightarrow I$ such that $h|_C = 0$ and $h|_{C'} = 1$. Indeed assume by induction that h is constructed in X_n . (Start the induction with $n = 0$ using the fact that A is normal.) If $F_\alpha : D_\alpha^{n+1} \rightarrow X_{n+1}$ is the characteristic map of an $(n+1)$ -cell with attaching map $f_\alpha : S^n \rightarrow X$ define $h_\alpha : F_\alpha^{-1}(C \cup C') \cup S^n \rightarrow I$ by $h_\alpha = 0$ in $F_\alpha^{-1}(C)$, $h_\alpha = 1$ in $F_\alpha^{-1}(C')$ and $h_\alpha = h \circ f_\alpha$ in S^n . Since D_α^{n+1} is normal we may extend h_α to a continuous function $h_\alpha : D_\alpha^{n+1} \rightarrow I$ (Tietze extension theorem [REF]). The h_α extend the construction to $h : X_{n+1} \rightarrow I$. \square

Example 1 *Complex projective space.*

$\mathbb{C}P^n$ is the space of complex lines through the origin in \mathbb{C}^{n+1} . S^{2n+1} is the unit sphere in \mathbb{C}^{n+1} . Thus assigning to $x \in S^{2n+1}$ the complex line $\mathbb{C}x$, we define a map $f : S^{2n+1} \rightarrow \mathbb{C}P^n$. The reader is invited to check that $\mathbb{C}P^{n+1} = \mathbb{C}P^n \cup_f e^{2n+2}$. This exhibits $\mathbb{C}P^n$ as a CW complex with one cell in each even dimension $2k$, $0 \leq k \leq n$. The CW complex $\mathbb{C}P^\infty$ is obtained as the union, $\bigcup_{n=0}^\infty \mathbb{C}P^n$. \square

Example 2 *Wedges.*

The wedge of based CW complexes, (X_α, x_α) , is a CW complex whose n -skeleton is the wedge of the n -skeleta of the X_α . \square

Example 3 *Products.*

Let X and Y be CW complexes. Denote the cells of X and Y respectively by e_α^n and f_β^m , and let $\phi_\alpha : D_\alpha^n \rightarrow X$ and $\psi_\beta : D_\beta^m \rightarrow Y$ be the characteristic maps for e_α^n and f_β^m .

The *product* of the CW complexes X and Y is the space $X \times Y$ with the following CW structure. The cells of dimension k are the products $e_\alpha^n \times f_\beta^m$ with $n + m = k$, and characteristic maps

$$D^{n+m} \xrightarrow{\cong} D^n \times D^m \xrightarrow{\phi_\alpha \times \psi_\beta} X \times Y.$$

The attaching map of $e_\alpha^n \times f_\beta^m$ is the restriction of the previous map to $\partial D^{n+m} \cong (\partial D^n \times D^m) \cup (D^n \times \partial D^m)$.

If X or Y is a finite CW complex then it is compact, and so the topology in $X \times Y$ is the ordinary product topology. \square

Example 4 *Quotients and suspensions.*

The quotient X/A for a relative CW complex (X, A) is a CW complex whose cells are the cells of X together with the additional 0-cell, $[A]$. In particular, the suspension of a based CW complex is again a based CW complex. \square

Example 5 *Cubes and spheres.*

The unit interval is a CW complex with three cells: $\{0\}$, $\{1\}$ and I . Thus the cube I^n inherits a (product) CW structure, and ∂I^n is a subcomplex. Note that the CW complex $I^n/\partial I^n$ coincides, as a CW complex, with the suspension of $I^{n-1}/\partial I^{n-1}$.

On the other hand, assign to S^n the basepoint $*$ = $(1, 0, 0, \dots, 0)$. The map $\theta : S^{n-1} \times I \rightarrow S^n$, represented by the picture

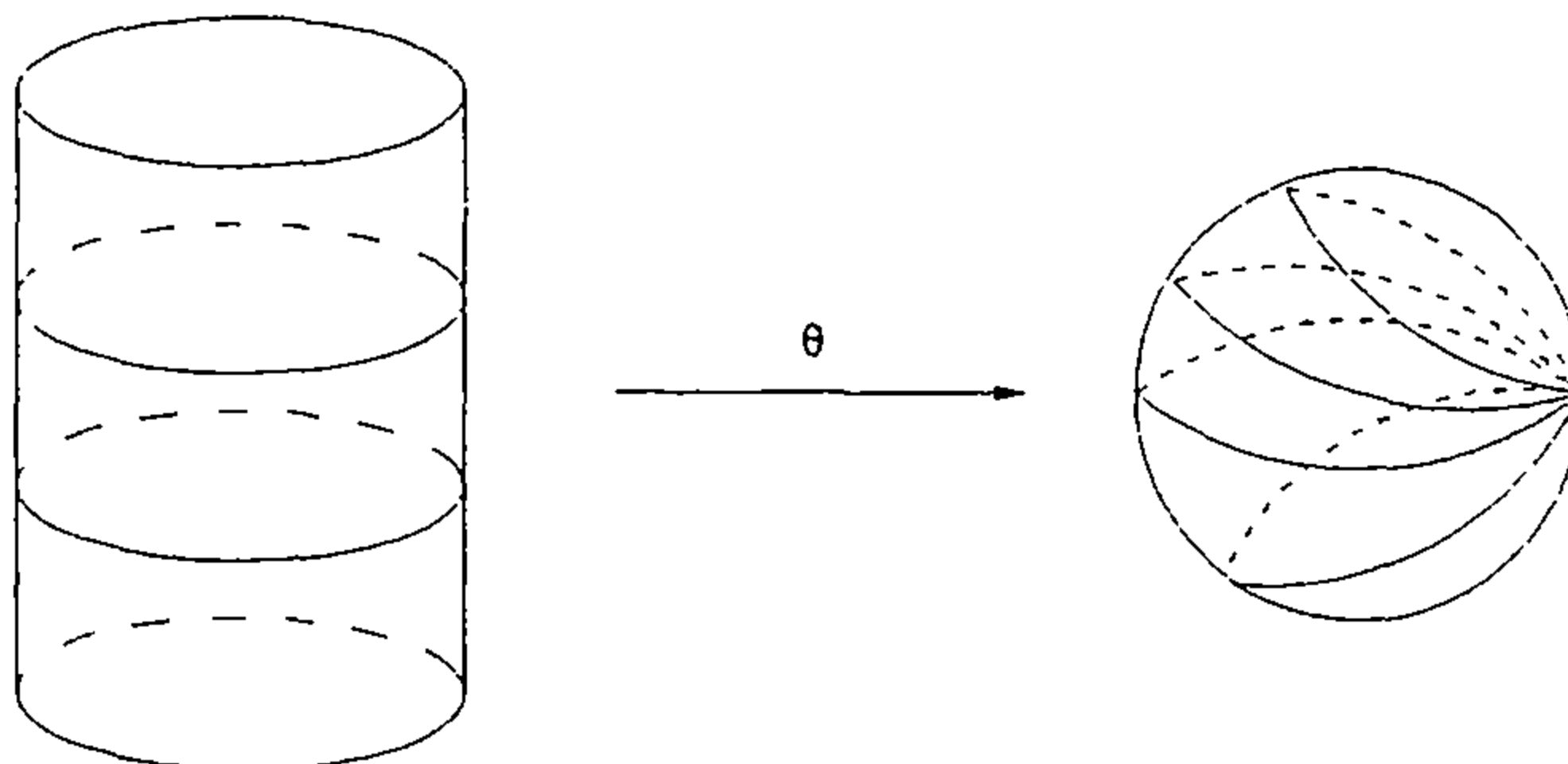

induces a based homeomorphism $\Sigma S^{n-1} \xrightarrow{\cong} S^n$. Identify $I/\partial I = S^1$ via the map $t \mapsto e^{2\pi it}$. Then we identify inductively

$$S^n = \Sigma S^{n-1} = \Sigma(I^{n-1}/\partial I^{n-1}) = I^n/\partial I^n.$$

This exhibits S^n as the CW complex $* \cup e^n$.

There is also a homeomorphism

$$\partial I^{n+1} \xrightarrow{\cong} S^n, \quad n \geq 1,$$

defined by translating I^{n+1} in \mathbb{R}^{n+1} to centre it at the origin, and then projecting the boundary onto S^n (explicitly, $x \mapsto (x - a)/\|x - a\|$, where $a = (\frac{1}{2}, \dots, \frac{1}{2})$). The corresponding base point of ∂I^{n+1} is $(1, \frac{1}{2}, \dots, \frac{1}{2})$. \square

Example 6 *Adjunction spaces.*

Suppose B is a subcomplex of a CW complex Z and $f : B \rightarrow X$ is a cellular map into a third CW complex. The adjunction space $X \cup_f Z$ is a CW complex whose cells are the cells of X together with the cells of the relative complex (Z, B) . \square

Example 7 *Mapping cylinders.*

Any continuous map $\varphi : X \rightarrow Y$ between CW complexes may be converted (up to homotopy) to the ‘inclusion of a subcomplex’ as follows: First, using Theorem 1.2 immediately below, replace φ by a homotopic cellular map ψ . Then attach $X \times I$ to Y along $X \times \{0\}$ via the map ψ to obtain the *mapping cylinder*, $Y \cup_\psi X \times I$:

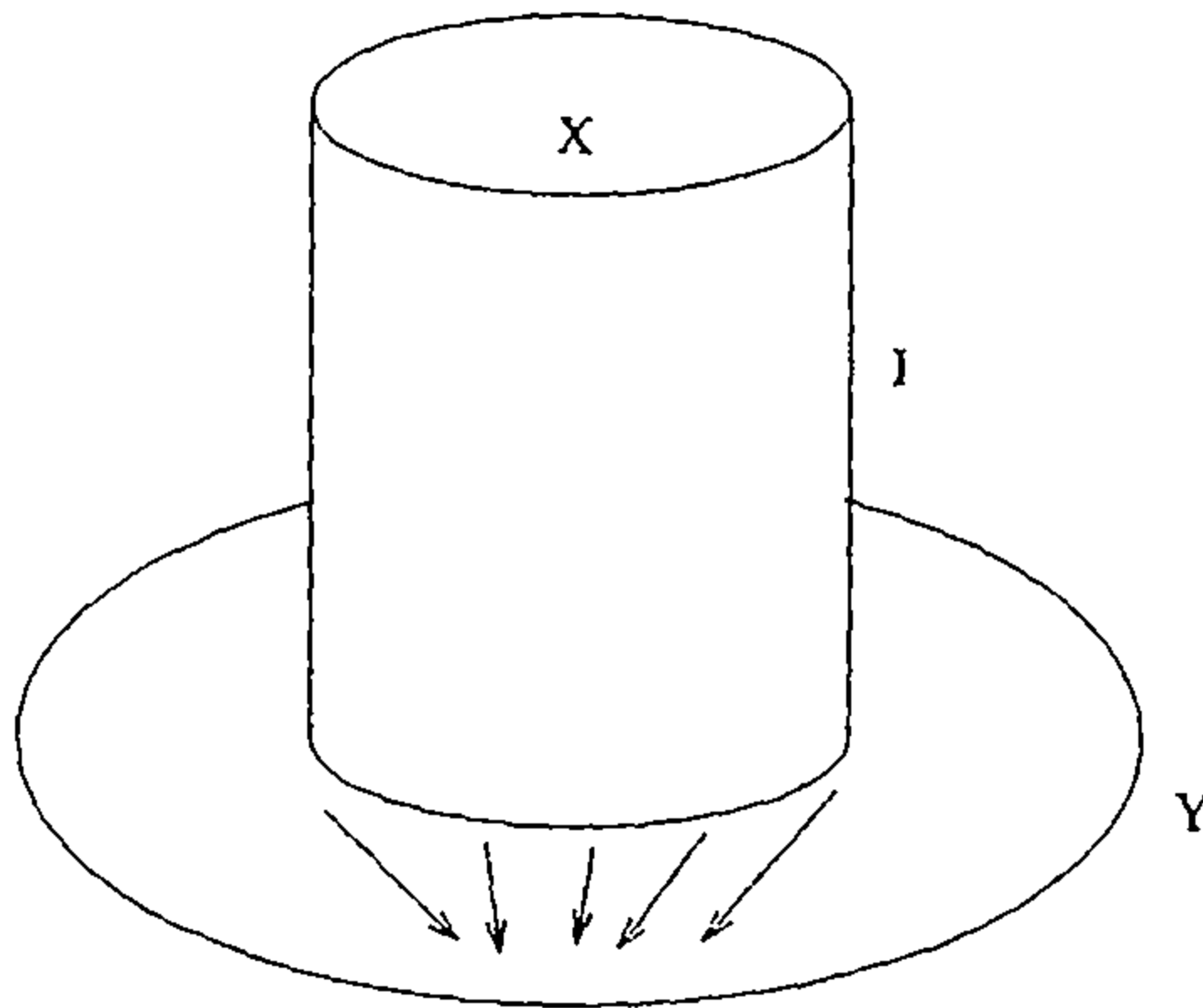

Since ψ is cellular, $Y \cup_\psi (X \times I)$ is a CW complex (Example 6). Moreover it contains Y as a strong deformation retract (push down the cylinder) and the inclusion of X as the subcomplex $X \times \{1\}$ is homotopic through the cylinder to ψ . \square

Next we turn to properties useful in homotopy theory. Since $(D^n \times I, D^n \times \{0\} \cup S^{n-1} \times I) \cong (D^n \times I, D^n \times \{0\})$, any continuous map from $D^n \times \{0\} \cup S^{n-1} \times I$ automatically extends to $D^n \times I$. Now suppose (X, A) is a relative CW complex, $f : X \rightarrow Y$ is continuous and $\Phi : A \times I \rightarrow Y$ is a homotopy from $f|_A$ to h . Then (by induction on the skeleta) $f \cup \Phi : X \times \{0\} \cup A \times I \rightarrow Y$ extends to a homotopy $X \times I \rightarrow Y$ from f to a map g . This *homotopy extension property* for relative CW complexes is important in the proof of

Theorem 1.2 (Cellular approximation) [160] *Any continuous map $f : (X, A) \rightarrow (Y, B)$ between relative CW complexes is homotopic rel A to a cellular map.*

proof: *Step (i) Linear approximation.* Suppose $\varphi : Z \rightarrow \mathbb{R}^k$ is a continuous map from a finite n -dimensional CW complex. Write $Z_r = Z_{r-1} \cup_{f_r} \left(\coprod_{\alpha} D_{\alpha}^r \right)$ and let $o_{r,\alpha}$ be the origin (centre) of D_{α}^r . Any point in D_{α}^r has the form tv with $v \in S_{\alpha}^{r-1}$, and $0 \leq t \leq 1$. The *linear approximation* of φ is the linear map $\theta : Z \rightarrow \mathbb{R}^k$ defined inductively by:

$$\theta = \varphi \text{ in } Z_0, \quad \text{and} \quad \theta(tv) = t\theta f_r(v) + (1-t)\varphi(o_{r,\alpha}), \quad tv \in e_{\alpha}^r.$$

An n -dimensional flat in \mathbb{R}^k is a subset of the form $v + W$ where $v \in \mathbb{R}^k$ and $W \subset \mathbb{R}^k$ is an n -dimensional subspace. An obvious induction shows that $\text{Im } \theta$ is contained in a finite union of n -dimensional flats. It is also contained in any convex set C such that $C \supset \text{Im } \varphi$. Finally, let $\varepsilon > 0$ and suppose for all cells e_{α}^r that $\|\varphi x - \varphi(o_{r,\alpha})\| < \varepsilon, x \in e_{\alpha}^r$. Since

$$\begin{aligned} \|\theta(tv) - \varphi(tv)\| &\leq t\|\theta f_r(v) - \varphi f_r(v)\| + t\|\varphi f_r(v) - \varphi(o_{r,\alpha})\| + \\ &\quad \|\varphi(o_{r,\alpha}) - \varphi(tv)\| \\ &< \|\theta f_r(v) - \varphi f_r(v)\| + 2\varepsilon, \end{aligned}$$

it follows by induction that $\|\theta x - \varphi x\| < 2n\varepsilon, x \in Z$.

Step (ii) The case $(X, A) = (D^n, S^{n-1})$. Since D^n is compact, $f : D^n \rightarrow Y$ has its image in some finite subcomplex $Z \supset B$. If $\dim Z \leq n$ there is nothing to prove. Otherwise write $Z = Z' \cup e^r$ for some subcomplex $Z' \supset B$ and some $r > n$. We construct $g \sim f \text{ rel } S^{n-1}$ so that $g : D^n \rightarrow Z' \cup_{\beta} (D^r - \{z\})$ for some z in the interior of D^r . But S^{r-1} is a strong deformation retract of $D^r - \{z\}$ and so Z' is a strong deformation retract of $Z' \cup_{\beta} (D^r - \{z\})$. Hence we can find $g' : D^n \rightarrow Z'$ with $g' \sim g \text{ rel } S^{n-1}$. After finitely many steps we have $f' \sim f \text{ rel } S^{n-1}$ and $f' : D^n \rightarrow Y_n$.

It remains to construct g . For this we may as well suppose that $Y = B \cup_{\beta} D^r, r > n$. Identify $(D^n, S^{n-1}) = (I^n, \partial I^n)$. The N^{th} subdivision of I^n is obtained by dividing I into N equal subintervals, regarding these as the 1-cells of a CW complex structure on I and giving I^n the product CW complex structure. This is illustrated for $n = 2$ by

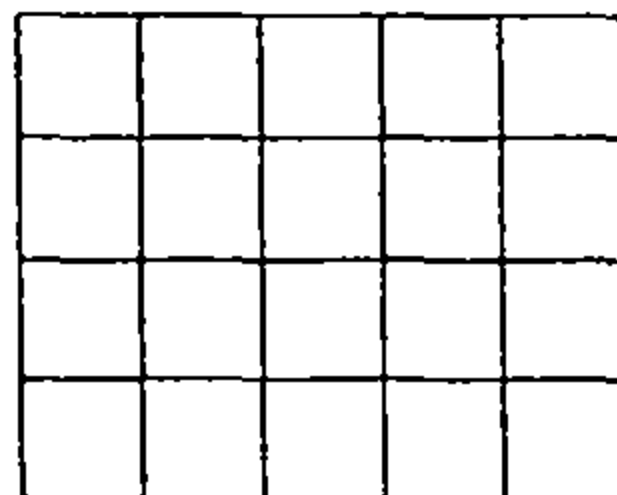

The cells of I^n will be called *little cubes*.

By setting $\|b\| = 1, b \in B$, we extend the standard length function in D^r to $\|-\| : Y \rightarrow I$. Choose N so large that for any little cube $I_\sigma, \left| \|fx_1\| - \|fx_2\| \right| < \frac{1}{10n}, x_1, x_2 \in I_\sigma$. The union of the little cubes satisfying $\|fx\| > \frac{1}{3}, x \in I_\sigma$, is a subcomplex L of I^n , and $\partial I^n \subset L$. Similarly the little cubes satisfying $\|fx\| < \frac{2}{3}, x \in I_\sigma$ are a subcomplex K , and $I^n = L \cup K$.

Regard $f|_K$ as a map into the disk $D \subset D^r$ of radius $\frac{2}{3}$. Since D is convex the linear approximation of $f|_K$ is a continuous map $\theta : K \rightarrow D$. Choose $h : Y \rightarrow I$ so that $h(y) = 0$ if $\|y\| \geq \frac{1}{3}$ and $h(y) = 1$ if $\|y\| \leq \frac{1}{4}$. Define $\Phi : I^n \times I \rightarrow Y$ by

$$\Phi(x, t) = \begin{cases} th(fx)\theta x + (1 - th(fx))fx & , x \in K \\ fx & , x \in L . \end{cases}$$

This is well defined because $h(fx) = 0$ if $x \in L$. Put $g(x) = \Phi(x, 1)$.

Next recall that $\text{Im } \theta$ is contained in a finite union of n -dimensional flats in \mathbb{R}^r . Since $n < r$ there is a point $z \in D^r - \text{Im } \theta$ such that $\|z\| < \frac{1}{20}$. If $x \in L$ then $\|gx\| = \|fx\| > \frac{1}{3}$. If $x \in K$ and $h(fx) \neq 1$ then $\|fx\| > \frac{1}{4}$. As noted above in (i), $\|\theta x - fx\| < \frac{2n}{10n} = \frac{1}{5}$. Hence $\|gx\| \geq \|fx\| - th(fx)\|\theta x - fx\| > \frac{1}{20}$. If $x \in K$ and $h(fx) = 1$ then $gx = \theta x$. In each case $gx \neq z$ and so $z \notin \text{Im } g$.

Step (iii) The general case. We construct a sequence of maps $f_n : X \rightarrow Y$ such that $f_0 = f$, and for $n \geq 1, f_n(X_{n-1}) \subset Y_{n-1}$, and $f_n \sim f_{n-1} \text{ rel } X_{n-2}$. Indeed given f_n we use Step (ii) in each n -cell of X to construct a homotopy $\Psi \text{ rel } X_{n-1}$, from $f_n|_{X_n}$ to a map $g : X_n \rightarrow Y_n$. Use the homotopy extension property to extend $\Psi \cup f_n : X_n \times I \cup X \times \{0\} \rightarrow Y$ to a map $\Phi_n : X \times I \rightarrow Y$ and put $f_{n+1}(x) = \Phi_n(x, 1)$.

Finally, let $\varepsilon_0 < \varepsilon_1 < \dots < \varepsilon_n < \dots$ be a sequence increasing from $0 = \varepsilon_0$ to 1. Let $H_n : X \times [\varepsilon_n, \varepsilon_{n+1}] \rightarrow Y$ be a map such that $H_n(x, \varepsilon_n) = f_n(x), H_n(x, \varepsilon_{n+1}) = f_{n+1}(x)$ and $H_n(x, t) = f_n(x), x \in X_{n-1}$. Define $H : X \times I \rightarrow Y$ by

$$H(x, t) = \begin{cases} H_n(x, t) & , \varepsilon_n \leq t \leq \varepsilon_{n+1} \\ f_n(x) & , x \in X_{n-1}, t \geq \varepsilon_n . \end{cases}$$

Then H is a homotopy rel A from f to a cellular map. □

(b) Homotopy groups.

For any based space (X, x_0) , we write

$$\pi_n(X, x_0) = [(S^n, *), (X, x_0)]$$

to denote the set of based homotopy classes of continuous maps $f : (S^n, *) \rightarrow (X, x_0)$. When $n = 0, \pi_0(X, x_0)$ is the set of path components of X , pointed by the path component of x_0 . *By convention this basepoint is denoted by 0.* If $\pi_0(X, x_0) = \{0\}$ then X is called *path connected*.

For $n \geq 1, \pi_n(X, x_0)$ is a group. Multiplication is defined via the identification $\pi_n(X, x_0) \cong \pi_n(S^n, *)$. Example 5 above: if $[f], [g] \in \pi_n(X, x_0)$ are represented by

$f, g : (\Sigma S^{n-1}, *) \rightarrow (X, x_0)$ then the product $[f] * [g]$ is represented by $f * g : (\Sigma S^{n-1}, *) \rightarrow (X, x_0)$, where

$$(f * g)(x, t) = \begin{cases} f(x, 2t) & 0 \leq t \leq \frac{1}{2} \\ g(x, 2t - 1) & \frac{1}{2} \leq t \leq 1 \end{cases}, \quad x \in S^{n-1}, t \in I.$$

The constant map $c : S^n \rightarrow x_0$ represents the identity of $\pi_n(X, x_0)$. A continuous map $\varphi : (X, x_0) \rightarrow (Y, y_0)$ induces the group homomorphisms $\pi_n(\varphi) : \pi_n(X, x_0) \rightarrow \pi_n(Y, y_0)$ given by $\pi_n(\varphi)[f] = [\varphi \circ f]$; $\pi_n(\varphi)$ depends only on the based homotopy class of φ .

Definition The groups $\pi_n(X, x_0)$ are the *homotopy groups* of (X, x_0) .

If $(X, *)$ and $(Y, *)$ are based topological spaces, then the projections of $X \times Y$ on X and on Y define group isomorphisms: $\pi_n(X \times Y, *) \xrightarrow{\cong} \pi_n(X, *) \times \pi_n(Y, *)$. We shall often identify these groups via this isomorphism.

The identification $S^n \cong I^n / \partial I^n$ of Example 5 identifies maps $(S^n, *) \rightarrow (X, x_0)$ with maps $(I^n, \partial I^n) \rightarrow (X, x_0)$, and then

$$(f * g)(t_1, \dots, t_n) = \begin{cases} f(t_1, \dots, 2t_n) & 0 \leq t_n \leq \frac{1}{2} \\ g(t_1, \dots, 2t_n - 1) & \frac{1}{2} \leq t_n \leq 1. \end{cases}$$

When $n \geq 1$ we could use the first coordinate t_1 instead of t_n to define a second product, $f \tilde{*} g$. Suppose $n \geq 2$. Then a simple check shows that there are homotopies rel ∂I^n :

$$f * g \sim (f \tilde{*} c) * (c \tilde{*} g) = (f * c) \tilde{*} (c * g) \sim f \tilde{*} g,$$

and

$$g * f \sim (c \tilde{*} g) * (f \tilde{*} c) = (c * f) \tilde{*} (g * c) \sim f \tilde{*} g.$$

Hence $\pi_n(X, x_0)$ is abelian for $n \geq 2$.

We recall Hopf's calculation of $\pi_i(S^n)$, $i \leq n$; the first assertion is a corollary of the cellular approximation Theorem 1.2.

Theorem 1.3 [159]

(i) For $i < n$, $\pi_i(S^n) = 0$.

(ii) For $n \geq 1$, $\pi_n(S^n) = \mathbb{Z}$, with $1 \in \mathbb{Z}$ represented by the identity map of S^n .

□

Given a path $w : I \rightarrow X$ and a map $f : (S^n, *) \rightarrow (X, w(0))$ we obtain a map $f \cdot w : (S^n, *) \rightarrow (X, w(1))$ as illustrated in the picture

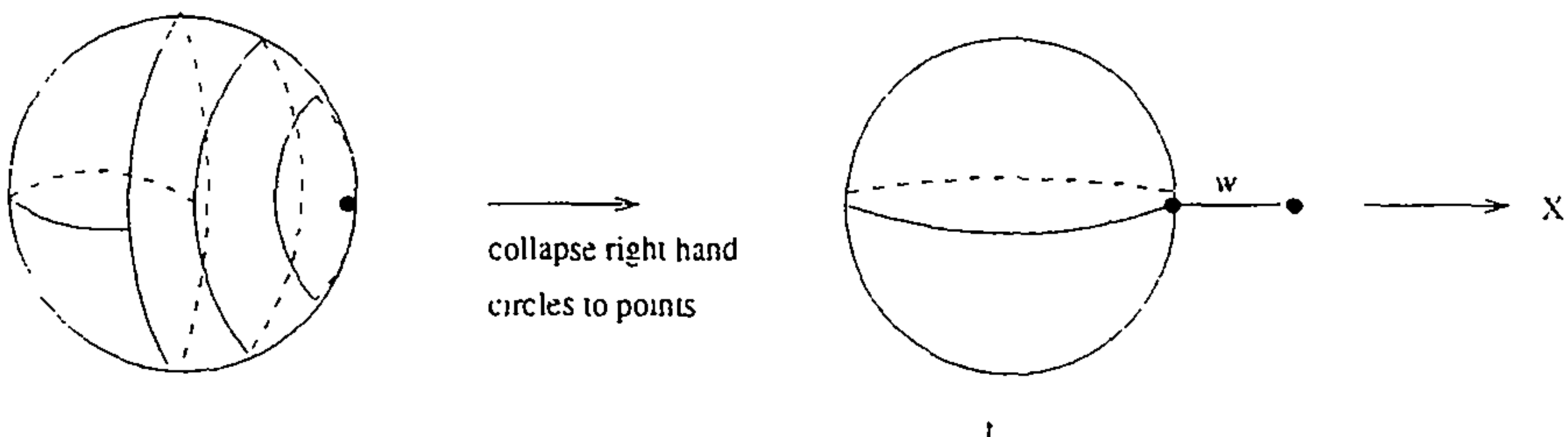

This correspondence defines an isomorphism $\pi_n(X, w(0)) \xrightarrow{\cong} \pi_n(X, w(1))$, and this isomorphism depends only on the homotopy class of w rel $\{0, 1\}$, cf. [159].

Thus if X is path connected the groups $\pi_n(X, x)$, $x \in X$, are all isomorphic. If they vanish for $1 \leq n \leq r$ then X is r -connected (when $r = 1$, X is called *simply connected*). When X is simply connected the isomorphisms $\pi_n(X, x) \cong \pi_n(X, y)$ are independent of the choice of path, and we write simply $\pi_n(X)$.

(c) Weak homotopy type.

A continuous map $f : Y \rightarrow Z$ is a *weak homotopy equivalence* if $\pi_0(f)$ and each

$$\pi_n(f) : \pi_n(Y, y) \rightarrow \pi_n(Z, f(y)), \quad y \in Y, \quad n \geq 1,$$

are bijections. Two spaces X and Y have the *same weak homotopy type* if they are connected by a chain of weak homotopy equivalences

$$X \longleftarrow Z(0) \longrightarrow \cdots \longleftarrow Z(n) \longrightarrow Y.$$

A *cellular model* for a topological space Y is a CW complex X , together with a weak homotopy equivalence $f : X \rightarrow Y$.

Theorem 1.4 (Cellular models theorem) [160]

- (i) Every space Y has a cellular model $f : X \rightarrow Y$.
- (ii) If $f' : X' \rightarrow Y$ is a second cellular model then there is a homotopy equivalence $g : X \xrightarrow{\cong} X'$ such that $f' \circ g \sim f$.

To prove this theorem one needs the fundamental

Lemma 1.5 (Whitehead lifting lemma) Suppose given a (not necessarily commutative) diagram

$$\begin{array}{ccc} A & \xrightarrow{\varphi} & Y \\ \downarrow i & & \downarrow f \\ X & \xrightarrow{\psi} & Z \end{array},$$

together with a homotopy $H : A \times I \rightarrow Z$ from ψi to $f \varphi$. Assume (X, A) is a relative CW complex and f is a weak homotopy equivalence.

Then φ and H can be extended respectively to a map $\Phi : X \rightarrow Y$ and a homotopy $K : X \times I \rightarrow Z$ from ψ to $f \circ \Phi$.

proof: As in the proof of Step (iii) in Theorem 1.2 it is enough, by induction on the cellular structure, to consider the case that $A = X_n$ and $X = X_{n+1}$. Then working one cell at a time reduces us to the case that $A = S^n$, $X = D^{n+1}$ and i is the standard inclusion. In this case $\varphi : (S^n, *) \rightarrow (Y, y_0)$ and $f \circ \varphi \sim \psi|_{S^n} \sim$

the constant map. Since f is a weak homotopy equivalence, φ itself is homotopic to the constant map via a homotopy H' .

This produces the map $\sigma : S^n \times I \cup D^{n+1} \times \{0, 1\} \rightarrow (Z, f(y_0))$, described in the following picture (for $n = 1$)

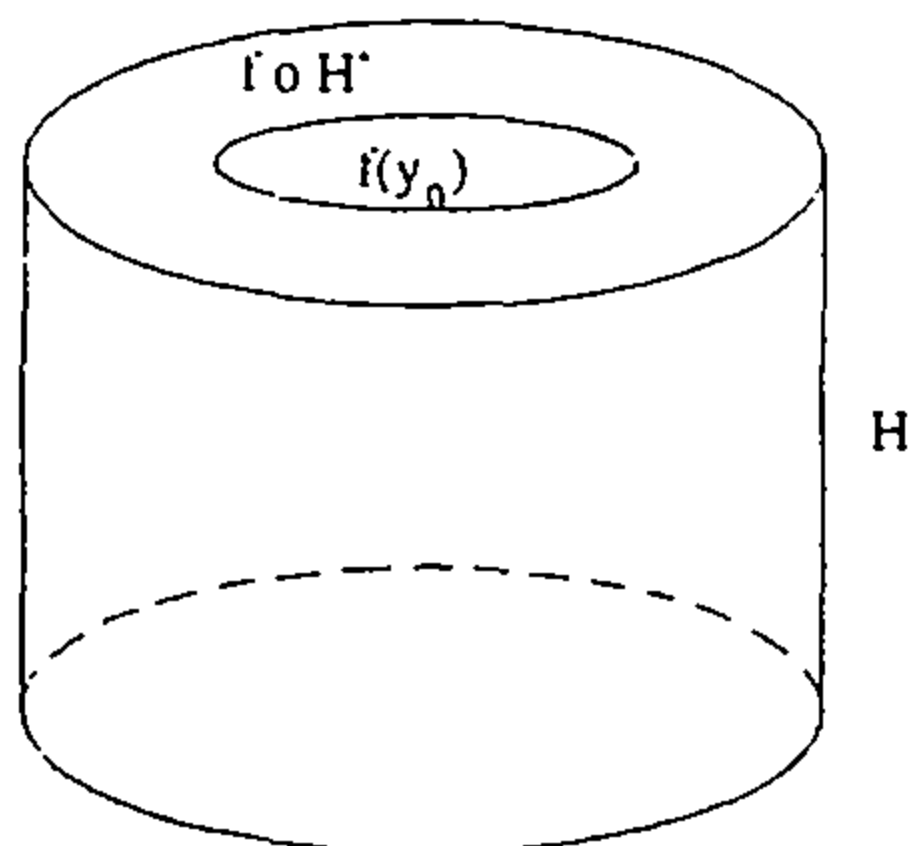

Since $S^n \times I \cup D^{n+1} \times \{0, 1\}$ is homeomorphic to S^{n+1} and since f is a weak homotopy equivalence, there is a map $\tau : (S^{n+1}, *) \rightarrow (Y, y_0)$ such that $\pi_{n+1}(f)[\tau] = [\sigma]^{-1}$.

Recall the homeomorphism $\Sigma S^n \xrightarrow{\cong} S^{n+1}$. This identifies τ as a map $\tau : (S^n \times I, S^n \times \{0, 1\}) \rightarrow (Y, y_0)$. Define $\Phi : D^{n+1} \rightarrow Y$ to be the map

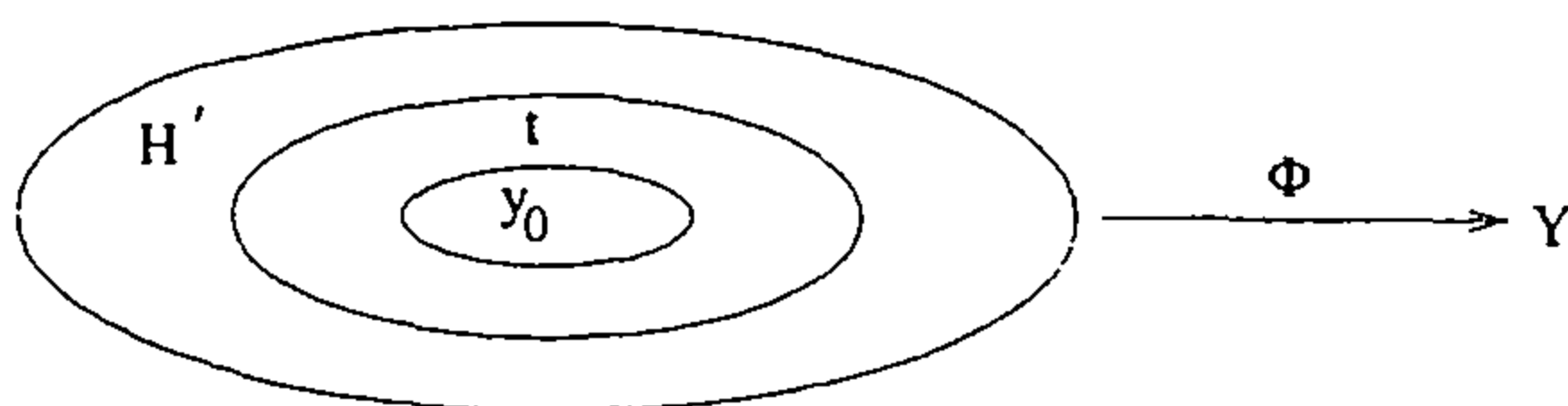

Then the map $\Psi : S^n \times I \cup D^{n+1} \times \{0, 1\} \rightarrow Z$ given by

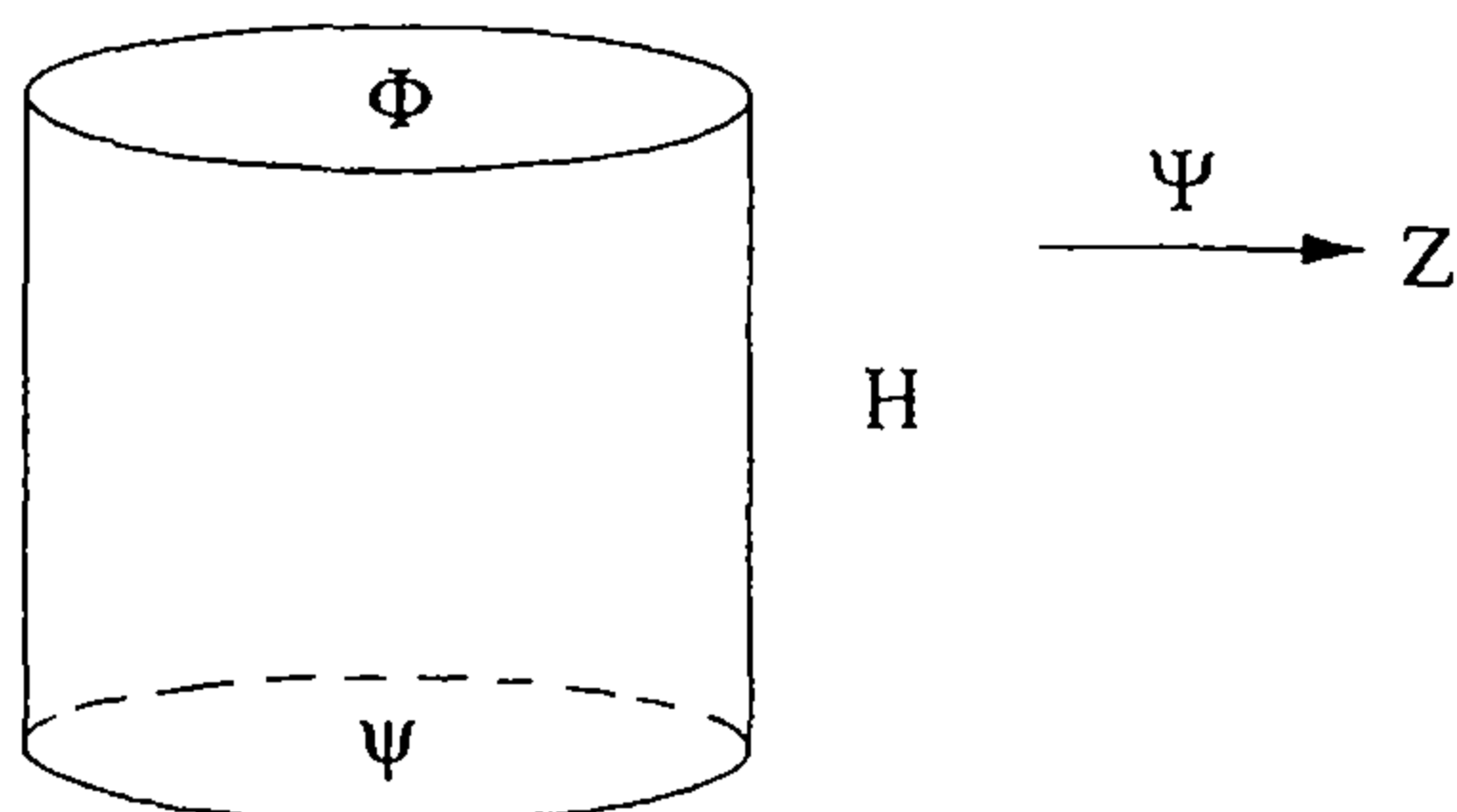

may be redrawn as

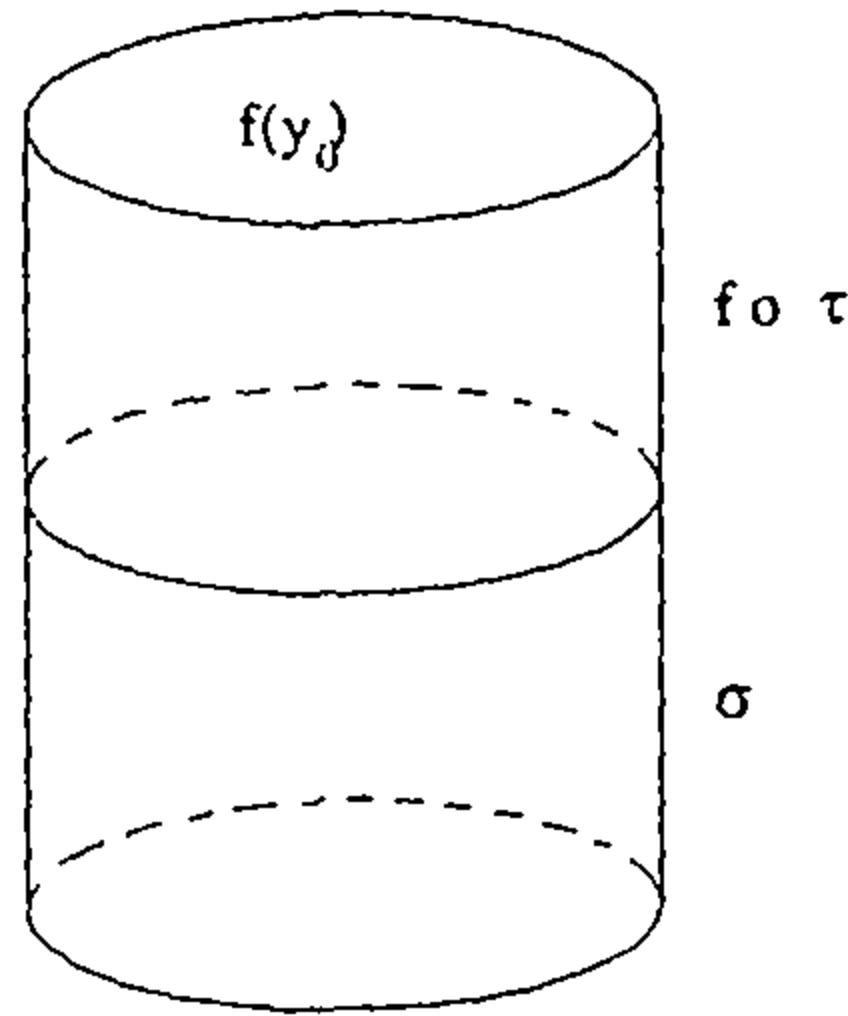

Hence Ψ represents $[\sigma] * [f \circ \tau] = 0$, and so it extends to $K : D^{n+1} \times I \rightarrow Z$, as desired. \square

Corollary 1.6 *If X is a CW complex and $f : Y \rightarrow Z$ is a weak homotopy equivalence then composition with f induces a bijection $f_{\#} : [X, Y] \rightarrow [X, Z]$ of homotopy classes of maps. Similarly, if (X, x_0) is a pointed CW complex then $f_{\#} : [(X, x_0), (Y, y_0)] \rightarrow [(X, x_0), (Z, f(y_0))]$ is a bijection.*

proof: The lifting theorem, applied with the relative CW complex (X, ϕ) , shows that $f_{\#}$ is surjective. Regard I as a CW complex with $I_0 = \{0, 1\}$ and $I_1 = I$. Then the lifting theorem applied with the relative CW complex $(X \times I, X \times \{0, 1\})$ shows that $f_{\#}$ is injective. A slight variation of this argument gives the pointed case. \square

Corollary 1.7

- (i) *A weak homotopy equivalence between CW complexes is a homotopy equivalence.*
- (ii) *If (X, A) is a relative CW complex and A has the homotopy type of a CW complex then X has the homotopy type of a CW complex.*

proof of Theorem 1.4: First we have to show that any space Y has a cellular model. It is sufficient to consider the case Y is path connected. We construct $f : X \rightarrow Y$ with X the union of subcomplexes $X^0 \subset X^1 \subset \dots \subset X^n \subset \dots$ and f^n the restriction of f to X^n . Fix a basepoint $y_0 \in Y$ and choose $f^0 : (X^0, *) = \bigvee_{\alpha, n} S_{\alpha}^n \rightarrow (Y, y_0)$ so that $\pi_i(f^0)$ is surjective for all i .

Assume $f^{n-1} : X^{n-1} \rightarrow Y$ is constructed so that also $\pi_i(f^{n-1})$ is injective for $i < n$. Since $S^n = * \cup e^n$, it follows from the cellular approximation theorem that $\pi_n((X^{n-1})_n) \rightarrow \pi_n(Y)$ is surjective. Thus we may add $(n+1)$ -cells $\{e_{\beta}^{n+1}\}$ to $(X^{n-1})_n$ to kill $\ker \pi_n(f^{n-1})$, and then extend over these cells to produce $f^n : X^n = X^{n-1} \cup \left(\bigcup_{\beta} e_{\beta}^{n+1} \right) \rightarrow Y$. The cellular approximation theorem then implies that $\pi_i(f^n)$ is injective for $i \leq n$.

The uniqueness (up to homotopy) of a cellular model follows at once from the Whitehead lifting lemma and its corollaries. \square

(d) Cofibrations and NDR pairs.

Suppose A is a subspace of a topological space X . The pair (X, A) is a *cofibration* if for any continuous map $f : X \rightarrow Y$ a homotopy $H : A \times I \rightarrow Y$ starting at $f|_A$ always extends to a homotopy $X \times I \rightarrow Y$ starting at f .

Lemma 1.8 (X, A) is a cofibration if and only if $X \times \{0\} \cup A \times I$ is a retract of $X \times I$.

proof: A continuous map $f : X \rightarrow Y$ and a homotopy $H : A \times I$ starting at $f|_A$ define a map $(f, H) : X \times \{0\} \cup A \times I \rightarrow Y$. If $r : X \times I \rightarrow X \times \{0\} \cup A \times I$ is a retraction then $(f, H) \circ r : X \times I \rightarrow Y$ extends H and starts at f . Conversely, if (X, A) is a cofibration take $Y = X \times \{0\} \cup A \times I$ and (f, H) the identity map. An extension of H starting at f is a retraction $r : X \times I \rightarrow X \times \{0\} \cup A \times I$. \square

Again suppose A is a subspace of a topological space X .

Definition (i) The pair (X, A) is a *DR pair* if A is a strong deformation retract of X and $A = h^{-1}(0)$ for some continuous function $h : X \rightarrow I$.

(ii) The pair (X, A) is an *NDR pair* if for some open $U \subset X$ there are continuous maps $H : U \times I \rightarrow X$ and $h : X \rightarrow I$ such that:

- $A = h^{-1}(0)$ and $U \supset h^{-1}([0, \epsilon))$, some $\epsilon > 0$.
- H is a homotopy rel A from the inclusion of U in X to a retraction $U \rightarrow A$.

(iii) A *well-based space* is a an NDR pair (X, x_0) .

Proposition 1.9

(i) If (X, A) and (Y, B) are NDR pairs then $(X \times Y, X \times B \cup A \times Y)$ is an NDR pair.

(ii) A relative CW complex (X, A) is an NDR pair.

proof: (i) Let H, h, U be as in the definition for the NDR pair (X, A) and let K, k, V be analogous maps and open set for (Y, B) . Define $\ell : X \times Y \rightarrow I$ by $\ell(x, y) = \inf(h(x), k(y))$. Choose a continuous function $\alpha : (I, [0, \epsilon/2], [\epsilon, 1]) \rightarrow (I, 1, 0)$ and define $H' : X \times I \rightarrow X, K' : Y \times I \rightarrow Y$ by

$$H'(x, t) = \begin{cases} H(x, \alpha(hx)t) & , \quad x \in U \\ x & , \quad hx > \epsilon \end{cases}$$

and

$$K'(y, t) = \begin{cases} K(y, \alpha(ky)t) & , y \in U \\ y & , ky > \varepsilon . \end{cases}$$

Define $L : X \times Y \times I \rightarrow X \times Y$ by

$$L(x, y, t) = \begin{cases} \left(H' \left(x, \frac{k(y)}{h(x)}t \right), K'(y, t) \right) & , k(y) < h(x) \\ \left(H'(x, t), K' \left(y, \frac{h(x)}{k(y)}t \right) \right) & , h(x) < k(y) \\ (H'(x, t), K'(y, t)) & , h(x) = k(y) . \end{cases}$$

Set $U' = h^{-1}([0, \varepsilon/2])$, $V' = k^{-1}([0, \varepsilon/2])$ and $W = U' \times Y \cup X \times V'$. Then L, ℓ, W exhibit $(X \times Y, A \times Y \cup X \times B)$ as an NDR pair (where we use $\varepsilon/2$ instead of ε).

(ii) Define a continuous function $h : X \rightarrow I$ by induction on the skeleta, as follows. Set $h = 0$ in A . If h is defined in X_{n-1} and $f_\alpha : S_\alpha^{n-1} \rightarrow X_{n-1}$ is the attaching map of an n -cell D_α^n then let $\| \cdot \|$ be the length function in D_α^n and extend h to X_n by

$$h(x) = (1 - \|x\|) + \|x\|h \left(f_\alpha \left(\frac{x}{\|x\|} \right) \right), \quad x \in D_\alpha^n .$$

Then $A = h^{-1}(0)$ and $h^{-1}([0, 1/4])$ is contained in the canonical extension of A to an open set U in X (away from the origins o_α of the cells D_α^n).

We show now that A is a strong deformation retract of U . Put $U_n = U \cap X_n$, and note that $U_0 = A$. Define a retraction $r_n : U_n \rightarrow U_{n-1}$ by $r_n(x) = f_\alpha(x/\|x\|)$, $x \in U \cap D_\alpha^n$, and define $K_n : U_n \times I \rightarrow U_n$ by $K_n(x, t) = (1 - t + t/\|x\|)x$, $x \in U \cap D_\alpha^n$. Thus K_n exhibits U_{n-1} as a strong deformation retract of U_n .

Put $r_{k,n} = r_k \circ \cdots \circ r_n : U_n \rightarrow U_{k-1}$. Then a retraction $r : U \rightarrow A$ is defined by $rx = r_{1,n}(x)$, $x \in U_n$. Set $I_n = \left[\frac{1}{n+1}, \frac{1}{n} \right]$ and turn K_n into a map $H_n : U_n \times I_n \rightarrow U_n$ via the obvious map $\left(I_n, \frac{1}{n+1}, \frac{1}{n} \right) \rightarrow (I, 0, 1)$. Define $H : U \times I \rightarrow U$ by setting (for $x \in U_n$)

$$H(x, t) = \begin{cases} x & , t \leq \frac{1}{n+1} . \\ H_n(x, t) & , t \in I_n . \\ H_k(r_{k+1,n}(x), t) & , t \in I_k, 1 \leq k < n . \end{cases}$$

Then H exhibits A as a strong deformation retract of U . □

It turns out that the condition 'NDR pair' is only slightly stronger than the condition 'cofibration'.

Proposition 1.10 *The following conditions are equivalent on a topological pair (X, A) :*

- (i) A is closed in X and (X, A) is a cofibration.
- (ii) (X, A) is an NDR pair.
- (iii) $(X \times I, X \times \{0\} \cup A \times I)$ is a DR pair.

proof: (i) \implies (ii): Let $r = (r_X, r_I) : X \times I \rightarrow X \times \{0\} \cup A \times I$ be a retraction (Lemma 1.8). Define $h : X \rightarrow I$ by $h(x) = \sup \{t - r_I(x, t) \mid t \in I\}$. Set $U = h^{-1}([0, 1))$, and set $H = r_X : U \times I \rightarrow X$.

(ii) \implies (iii): Let h, U, ε and H be as in the definition of NDR pairs. Choose a continuous function $\alpha : (I, [0, \varepsilon/2], [\varepsilon, 1]) \rightarrow (I, 1, 0)$ and set $\varphi = \alpha h : X \rightarrow I$. Define $K : X \times I \rightarrow X$ by

$$K(x, t) = \begin{cases} H(x, (\varphi x)t) & , \quad x \in U \\ x & , \quad hx > \varepsilon . \end{cases}$$

Define $k : X \rightarrow I$ by $kx = \inf(\frac{2}{\varepsilon}hx, 1)$. Then $K : k^{-1}([0, 1)) \times \{1\} \rightarrow A$. Define a homotopy $\Phi : (X \times I) \times I \rightarrow X \times I$ by

$$\Phi(x, t, s) = \begin{cases} \left(K(x, \frac{st}{kx}), t(1-s) \right) & , \quad t < kx \\ (K(x, s), t - skx) & , \quad t \geq kx . \end{cases}$$

It is straightforward to see that Φ is a homotopy rel $X \times \{0\} \cup A \times I$ from $id_{X \times I}$ to a retraction onto $X \times \{0\} \cup A \times I$.

(iii) \implies (i): This is Lemma 1.8. □

Proposition 1.11 *Suppose (X, A) is an NDR pair. Then the inclusion $i : A \rightarrow X$ is a homotopy equivalence if and only if (X, A) is a DR pair. In this case $(X \times I, X \times \{0, 1\} \cup A \times I)$ is a DR pair.*

proof: If (X, A) is a DR pair then i is certainly a homotopy equivalence. Suppose that i is a homotopy equivalence. Choose $\rho : X \rightarrow A$ so that $\rho i \sim id_A$. Extend the homotopy to a homotopy $X \times I \rightarrow A$ from ρ to a map $r : X \rightarrow A$. Clearly $ri = id_A$. Now, since i is a homotopy equivalence, there is a homotopy $H : X \times I \rightarrow X$ from id_X to ir . Define $K : X \times I \times \{0\} \cup X \times \{1\} \times I \cup A \times I \times I \rightarrow X$ by setting

$$K(x, t, 0) = \begin{cases} H(x, 2t) & , \quad 0 \leq t \leq \frac{1}{2} \\ H(irx, 2 - 2t) & , \quad \frac{1}{2} \leq t \leq 1 , \end{cases}$$

$$K(x, 1, t) = irx ,$$

and

$$K(a, t, s) = \begin{cases} H(a, 2(1-s)t) & , \quad 0 \leq t \leq \frac{1}{2} \\ H(a, 2(1-s)(1-t)) & , \quad \frac{1}{2} \leq t \leq 1 . \end{cases}$$

It is easy to construct a homeomorphism

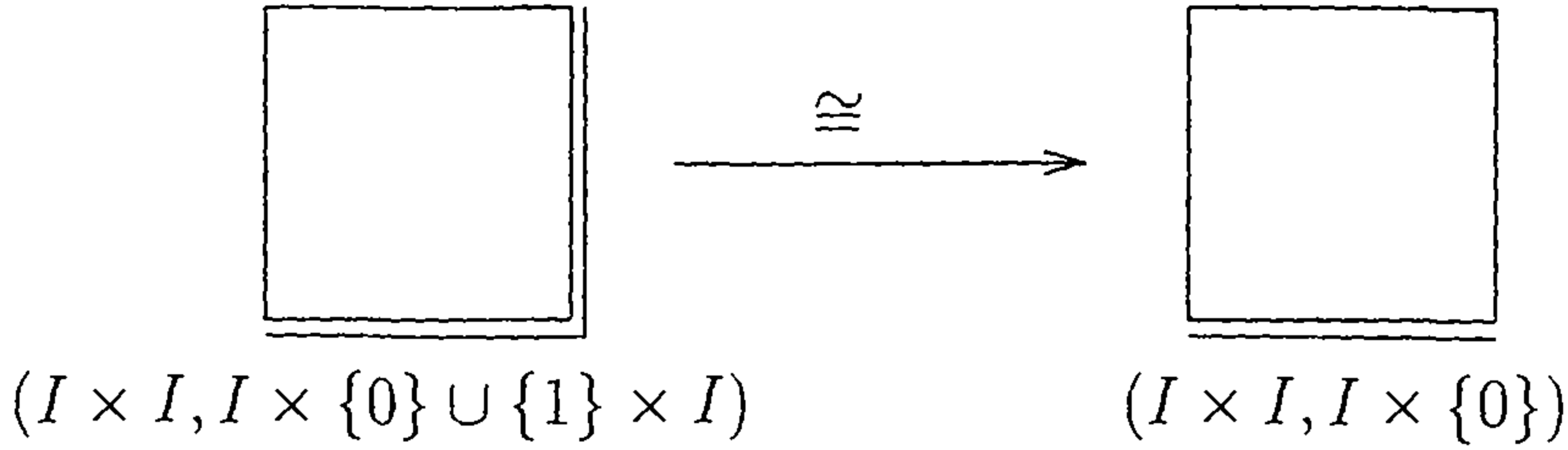

Thus $(X \times I \times I, X \times I \times \{0\} \cup X \times \{1\} \times I \cup A \times I \times I) \cong (X \times I \times I, X \times I \times \{0\} \cup A \times I \times I)$, which is a DR pair by Proposition 1.10. In particular K extends to a map $K : X \times I \times I \rightarrow X$, and $K(x, t, 1)$ is a homotopy rel A from id_X to ir . Thus (X, A) is a DR pair.

Finally, since (X, A) is a DR pair, clearly $A \times \{1\}$ and $A \times \{0\}$ are strong deformation retracts of $X \times \{0\}$ and $X \times \{1\}$, and so $A \times I$ is a strong deformation retract of $X \times \{0, 1\} \cup A \times I$. Since the composite $A \times I \rightarrow X \times \{0, 1\} \cup A \times I \rightarrow X \times I$ is also a homotopy equivalence it follows that the inclusion $X \times \{0, 1\} \cup A \times I \rightarrow X \times I$ is a homotopy equivalence as well. Thus $(X \times I, X \times \{0, 1\} \cup A \times I)$ is a DR pair by the first assertion of the proposition. \square

(e) Adjunction spaces.

If (X, A) is an NDR pair and $f : A \rightarrow Y$ is a continuous map then it is immediate that $(Y \cup_f X, Y)$ is also an NDR pair. (Note that a continuous function $h : X \rightarrow I$ with $h^{-1}(0) = A$ can be used to separate the points of Y from the points of $X - A$, so $Y \cup_f X$ is Hausdorff.)

Lemma 1.12 *If (X, A) is an NDR pair and $f_0, f_1 : A \rightarrow Y$ are homotopic continuous maps then $Y \cup_{f_0} X \simeq Y \cup_{f_1} X$.*

proof: Choose a homotopy $H : A \times I \rightarrow Y$ from f_0 to f_1 . Denote $X \times \{t\} \cup A \times I$ by $B_t \subset X \times I$. Proposition 1.10 implies that each B_t is a strong deformation retract of $X \times I$. Hence $Y \cup_H B_0$ and $Y \cup_H B_1$ are strong deformation retracts of $Y \cup_H (X \times I)$. But $Y \cup_H B_0 = Y \cup_{f_0} X$ and $Y \cup_H B_1 = Y \cup_{f_1} X$. \square

Next, consider a commutative diagram

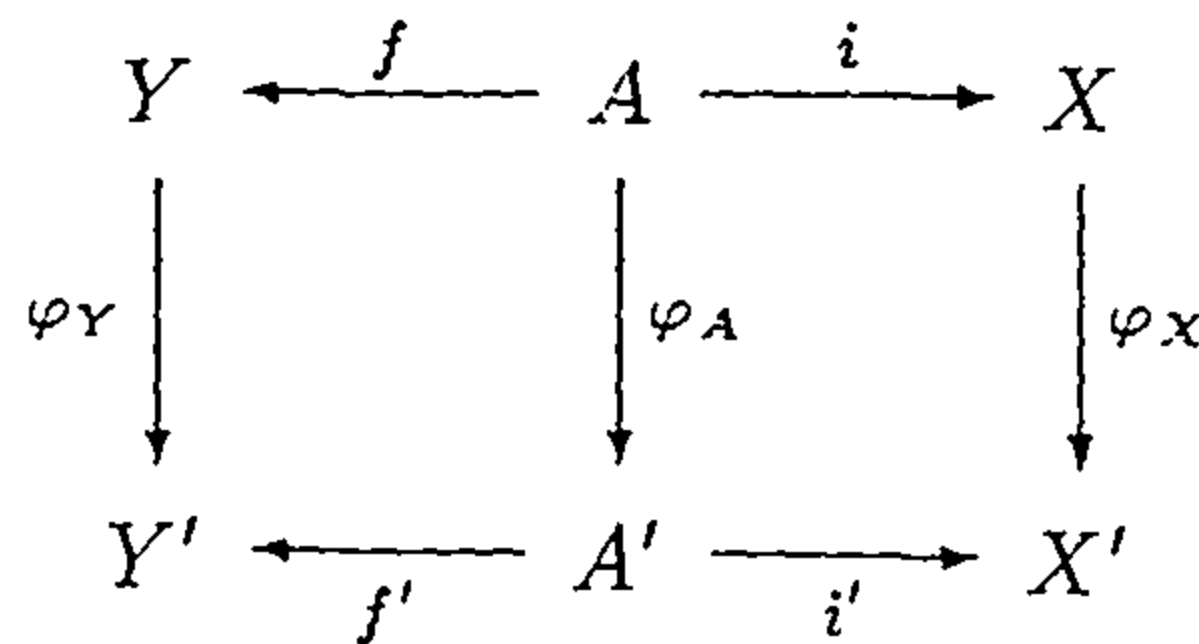

of continuous maps.

Theorem 1.13 *If i and i' are the inclusions of NDR pairs and if φ_Y, φ_A and φ_X are homotopy equivalences then*

$$\varphi = (\varphi_Y, \varphi_X) : Y \cup_f X \rightarrow Y' \cup_{f'} X'$$

is a homotopy equivalence too.

The proof will rely frequently on the following obvious remark.

Lemma 1.14 *If (B, C) is a DR pair and $h : D \rightarrow W$ is a continuous map from a closed subspace $D \subset C$ then $(W \cup_h B, W \cup_h C)$ is a DR pair. In particular, the inclusion*

$$W \cup_h C \hookrightarrow W \cup_h B$$

is a homotopy equivalence. □

proof of Theorem 1.13: Identify (X, A) with $(X, A) \times \{1\} \subset X \times I$. Then $(X \times I, X)$ is a DR pair (trivially) and $(X \times I, X \times \{0\} \cup A \times I)$ is a DR pair by Proposition 1.10. Moreover f is identified as a map $f : A \times \{1\} \rightarrow Y$ and by Lemma 1.14,

$$Y \cup_f (X \times \{0\} \cup A \times I) \rightarrow Y \cup_f (X \times I) \leftarrow Y \cup_f X$$

are homotopy equivalences.

Denote $X \amalg Y$ by Z and $\varphi_X \amalg \varphi_Y$ by φ_Z , and define $g : A \times \{0, 1\} \rightarrow Z$ by $g(a, 0) = ia$ and $g(a, 1) = fa$. Then $Y \cup_f (X \times \{0\} \cup A \times I) = Z \cup_g (A \times I)$. It is thus sufficient to show that

$$(\varphi_Z, \varphi_A \times id) : Z \cup_g (A \times I) \rightarrow Z' \cup_{g'} (A' \times I)$$

is a homotopy equivalence. Since this map factors as

$$Z \cup_g (A \times I) \rightarrow Z' \cup_{\varphi_Z g} (A \times I) \rightarrow Z' \cup_{g'} (A' \times I)$$

it is sufficient to consider the two special cases: either $A = A'$ and $\varphi_A = id$ or else $Z = Z'$ and $\varphi_Z = id$.

Case 1: $Z = Z'$ and $\varphi_Z = id$:

Regard φ_A as a map $A \times \{0\} \rightarrow A'$ and set $B = A' \cup_{\varphi_A} (A \times I)$. Define a retraction $r : B \rightarrow A'$ by $r(a, t) = \varphi_A a$, and set

$$g_B = g' \circ (r \times id) : B \times \{0, 1\} \rightarrow Z .$$

If $C \subset B$ let $g_C : C \times \{0, 1\} \rightarrow Z$ be the restriction of g_B . Thus the inclusion of C in B and the retraction r define an inclusion and retraction

$$Z \cup_{g_C} (C \times I) \xrightarrow{j_C} Z \cup_{g_B} (B \times I) \xrightarrow{\rho} Z \cup_{g'} (A' \times I) .$$

Now suppose (B, C) is a DR pair. Then so is $(B \times I, B \times \{0, 1\} \cup C \times I)$, by Proposition 1.11. Since $Z \cup_{g_C} (C \times I) = Z \cup_{g_B} (B \times \{0, 1\} \cup C \times I)$ it follows that j_C is a homotopy equivalence (Lemma 1.14). In particular (B, A') is a DR pair and, clearly, $\rho j_{A'} = id$. Thus ρ is a homotopy equivalence. Moreover, if we identify $A = A \times \{1\} \subset B$ then the inclusion is a homotopy equivalence

because φ_A is. Thus (B, A) is a DR pair (Proposition 1.11) and j_A is a homotopy equivalence.

Finally, $(id_Z, \varphi_A \times id) = \varrho j_A$ and so it is a homotopy equivalence too.

Case 2: $A = A'$ and $\varphi_A = id$:

Denote $(A \times I, A \times \{0, 1\})$ by (B, C) . Thus $g : C \rightarrow Z$ and we have to show that if $\varphi_Z : Z \rightarrow Z'$ is a homotopy equivalence so is $(\varphi_Z, id) : Z \cup_g B \rightarrow Z' \cup_{\varphi_Z g} B$.

Suppose first that $Z = Z'$ and $id_Z \sim \varphi_Z$ via a homotopy $K : Z \times I \rightarrow Z$. Set $H = K \circ (g \times id) : C \times I \rightarrow Z$ and set

$$\Phi = (K, id_{B \times I}) : (Z \cup_g B) \times I \rightarrow Z \cup_H (B \times I).$$

In the proof of Lemma 1.12 we observed that the inclusions $b \mapsto (b, 0)$ and $b \mapsto (b, 1)$ of B in $B \times I$ induce homotopy equivalences $j_0 : Z \cup_g B \rightarrow Z \cup_H (B \times I)$ and $j_1 : Z \cup_{\varphi_Z g} B \rightarrow Z \cup_H (B \times I)$. A quick check shows that Φ is a homotopy from j_0 to $j_1 \circ (\varphi_Z, id)$. Hence (φ_Z, id) is a homotopy equivalence.

Now suppose φ_Z is any homotopy equivalence and choose a homotopy inverse $\psi_Z : Z' \rightarrow Z : \psi_Z \varphi_Z \sim id_{Z'}$ and $\varphi_Z \psi_Z \sim id_Z$. Form the sequence

$$Z \cup_g B \xrightarrow{\gamma_0} Z \cup_{\varphi_Z g} B \xrightarrow{\gamma_1} Z \cup_{\psi_Z \varphi_Z g} B \xrightarrow{\gamma_2} Z \cup_{\varphi_Z \psi_Z \varphi_Z g} B,$$

where $\gamma_0 = (\varphi_Z, id)$, $\gamma_1 = (\psi_Z, id)$ and $\gamma_2 = (\varphi_Z, id)$.

The argument above shows that $\gamma_1 \gamma_0$ and $\gamma_2 \gamma_1$ are both homotopy equivalences; i.e., they have homotopy inverses α and β . Thus $\beta \gamma_2 \sim \beta \gamma_2 \gamma_1 \gamma_0 \alpha \sim \gamma_0 \alpha$, and so $\gamma_1 (\beta \gamma_2 \gamma_1 \gamma_0 \alpha) \sim \gamma_1 \beta \gamma_2 \sim \gamma_1 \gamma_0 \alpha \sim id_Z$ and $(\beta \gamma_2 \gamma_1 \gamma_0 \alpha) \gamma_1 \sim id_{Z'}$. Thus γ_1 is a homotopy equivalence. Hence so is $\gamma_0 = (\varphi_Z, id)$. \square

Corollary *If (X, A) is an NDR pair and A is contractible then the quotient map $q : X \rightarrow X/A$ is a homotopy equivalence.*

proof: Identify q as the map $(c, id) : A \cup_{id_A} X \rightarrow pt \cup_c X$, where $c : A \rightarrow pt$, and note that c is a homotopy equivalence by hypothesis. \square

(f) Cones, suspensions, joins and smashes.

The *cone*, CX , on a topological space X is the space $X \times I / X \times \{0\}$, and the point $[X \times \{0\}]$ is called the *cone point*. We usually denote the point (x, t) by tx , so that $0x$ is the cone point (any $x \in X$). This identifies X as the subspace $X \times \{1\}$ and clearly (CX, X) is an NDR pair.

Recall that the *suspension* of a based topological space (X, x_0) is the based space

$$\Sigma X = (X \times I) / X \times \{0, 1\} \cup \{x_0\} \times I = CX / X \cup \{x_0\} \times I.$$

Any continuous map $f : (X, x_0) \rightarrow (Y, y_0)$ *suspends* to the map $\Sigma f : \Sigma X \rightarrow \Sigma Y$ induced from $f \times id_I$. Note that if (X, x_0) is well based then $(X \times I, X \times \{0, 1\} \cup \{x_0\} \times I)$ is an NDR pair (Proposition 1.9). Hence ΣX is well based. Moreover, if

(Y, y_0) is also well based then Theorem 1.13 implies that homotopy equivalences suspend to homotopy equivalences.

The *join* of two topological spaces X and Y is the subspace $X * Y \subset CX \times CY$ of points of the form $(tx, (1 - t)y)$, $t \in I$. (Thus $X * Y$ is the union of intervals joining $x \in X$ to $y \in Y$.) Notice that a homeomorphism

$$(CX \times Y) \cup_{X \times Y} (X \times CY) \xrightarrow{\cong} X * Y \tag{1.15}$$

is given by $(tx, y) \mapsto (\frac{t}{2}x, (1 - \frac{t}{2})y)$ and $(x, ty) \mapsto ((1 - \frac{t}{2})x, \frac{t}{2}y)$.

More generally, the *n-fold join* $X_1 * \dots * X_n$ of topological spaces X_i is the subspace of $CX_1 \times \dots \times CX_n$ of points (t_1x_1, \dots, t_nx_n) satisfying $\sum t_i = 1$. Note the obvious identifications

$$(X_1 * X_2) * X_3 = X_1 * X_2 * X_3 = X_1 * (X_2 * X_3) .$$

Next, recall that the wedge $X \vee Y$ of based spaces (X, x_0) and (Y, y_0) is the subspace $X \times \{y_0\} \cup \{x_0\} \times Y$ of $X \times Y$. The *smash product* of X and Y is the space

$$X \wedge Y = X \times Y / X \vee Y .$$

In particular ΣX coincides with $X \wedge S^1$ and so

$$X \wedge \Sigma Y = X \wedge Y \wedge S^1 = \Sigma(X \wedge Y) . \tag{1.16}$$

Proposition 1.17 *If (X, x_0) and (Y, y_0) are well based spaces then there is a homotopy equivalence, $X * Y \xrightarrow{\cong} \Sigma(X \wedge Y)$.*

proof: Embed I as Ix_0 and Iy_0 in CX and CY . Identify $CX \cup_I CY$ as the subspace of $X * Y$ of points $(tx, (1 - t)y)$ such that either $x = x_0$ or $y = y_0$. Now $(CX \cup_I CY)/I = (CX/I) \vee (CY/I)$. Since I is contractible we can apply the Corollary to Theorem 1.13 to obtain

$$CX \cup_I CY \simeq (CX \cup_I CY) / I \simeq CX \vee CY \simeq \{pt\} .$$

Hence (by the same Corollary) the quotient map $X * Y \rightarrow X * Y / CX \cup_I CY$ is a homotopy equivalence.

But if $q : X \times Y \times I \rightarrow X * Y$ is the quotient map $(x, y, t) \mapsto (tx, (1 - t)y)$ then $q^{-1}(CX \cup_I CY)$ is just $(X \vee Y) \times I$. Hence q induces a homeomorphism $\Sigma(X \wedge Y) \xrightarrow{\cong} X * Y / CX \cup_I CY$. □

Exercises

1. Prove that $P(X, x_0)$ is contractible and that X and $X^{[0,1]}$ have the same homotopy type.

2. Let X, Y and Z be based spaces. Prove that $(X \vee Y) \wedge Z \cong (X \wedge Z) \vee (Y \wedge Z)$, $(X \wedge Y) \vee Z \cong (X \vee Z) \wedge (Y \vee Z)$ and $(X \wedge Y) \wedge Z \cong X \wedge (Y \wedge Z)$.
3. Prove that $X * Y$ is homeomorphic to the inverse image of the set $\{(s, t) \in [0, 1]^2, s + t = 1\}$ under the mapping $CX \times CY \rightarrow [0, 1]^2, ([x, s], [y, t]) \mapsto (s, t)$.
4. By considering the mapping $\mathbb{R}^{m+1} \times \mathbb{R}^{n+1} \times [0, 1] \rightarrow \mathbb{R}^{m+n+2}, (x, y, t) \mapsto (x \cos \frac{\pi t}{2}, y \sin \frac{\pi t}{2})$, prove that $S^n * S^m \cong S^{m+n+1}$.
5. Let $f : S^3 \rightarrow \mathbb{C}P^1 = S^2$ be the map defined by $f(z_1, z_2) = [z_1, z_2]$. Prove that there exists a homeomorphism from the cofibre of f onto $\mathbb{C}P^2$.
6. Let (X, x_0) and (Y, y_0) be based spaces. Prove that the inclusion $X \vee Y \hookrightarrow X \times Y$ is a cofibration whose cofibre has the same homotopy type as $X \wedge Y$ and that $\Sigma(X \times Y)$ has the same homotopy type as $\Sigma X \vee \Sigma Y \vee \Sigma(X \wedge Y)$.

2 Fibrations and topological monoids

A continuous map $p : X \rightarrow Y$ has the *lifting property* with respect to a pair of topological spaces (Z, A) if for every commutative diagram of the form

$$\begin{array}{ccc} A & \xrightarrow{f} & X \\ \downarrow i & & \downarrow p \\ Z & \xrightarrow{g} & Y \end{array},$$

there exists a continuous map $k : Z \rightarrow X$ such that $pk = g$ and $ki = f$.

A surjective continuous map $p : X \rightarrow Y$ is a *Serre fibration* if it has the lifting property with respect to $(Z \times I, Z \times \{0\})$ for all CW complexes Z , and a *fibration* if it has the lifting property with respect to $(Z \times I, Z \times \{0\})$ for all topological spaces Z . Here X is called *the total space*, p *the projection* and Y *the base* of the fibration. The space $X_y = p^{-1}(y) \subset X$ is called *the fibre at y* . If Y has a fixed basepoint y_0 we often denote the fibre at y_0 by F and denote the (Serre) fibration by $F \rightarrow X \xrightarrow{p} Y$.

A *fibre-preserving* map between (Serre) fibrations is a commutative square of continuous maps

$$\begin{array}{ccc} X' & \xrightarrow{f} & X \\ \downarrow p' & & \downarrow p \\ Y' & \xrightarrow{g} & Y \end{array}$$

in which p' and p are (Serre) fibrations.

In this section we first establish a long exact sequence connecting the homotopy groups of the fibre, total and base spaces of a fibration. Next, we construct the Moore loop space ΩX of a based topological space $(X, *)$. This is a topological monoid acting on the contractible path space, PX , which identifies ΩX as the fibre of the path space fibration $PX \rightarrow X$.

This construction generalizes. Given a continuous map $f : X \rightarrow Y$ there is a homotopy equivalence $X \times_Y MY \xrightarrow{\cong} X$ which converts f into a fibration whose fibre $X \times_Y PY$ admits a natural action of ΩY . The projection $X \times_Y PY \rightarrow X$ is then also a fibration (the *holonomy fibration*) with fibre ΩY given by the action.

Finally, we consider principal bundles with fibre a topological group and construct their classifying spaces.

This section is organized into the following topics:

- (a) Fibrations .
- (b) Topological monoids and G -fibrations.
- (c) The homotopy fibre and the holonomy action.

(d) Fibre bundles and principal bundles.

(e) Associated bundles, classifying spaces, the Borel construction and the holonomy fibration.

(a) **Fibrations.** We begin with some examples.

Example 1 *Products.*

The projection $Y \times F \rightarrow Y$ is a fibration (the *trivial fibration*). \square

Example 2 *Covering projections.*

These are fibrations [68]. \square

Example 3 *Fibre products and pullbacks.*

Given continuous maps $A \xrightarrow{f} Y \xleftarrow{p} X$, recall that the *fibre product* $A \times_Y X \subset A \times X$ is the subspace of pairs (a, x) such that $f(a) = p(x)$. It fits into the commutative *pullback diagram*

$$\begin{array}{ccc} A \times_Y X & \xrightarrow{g} & X \\ \downarrow p_A & & \downarrow p \\ A & \xrightarrow{f} & Y \end{array}$$

in which p_A and g are projection on the first and second factors. If $p : X \rightarrow Y$ is a (Serre) fibration then so is $p_A : A \times_Y X \rightarrow A$. It is called the *pullback fibration*.

When $f : A \rightarrow Y$ is the inclusion of a subspace then $A \times_Y X = p^{-1}(A)$ and the fibration p_A is called the *restriction of the original fibration to A* . \square

Proposition 2.1 (i) *A fibration $p : X \rightarrow Y$ has the lifting property with respect to any DR pair (Z, A) . In particular, if (W, B) is any NDR pair then p has the lifting property with respect to $(W \times I, W \times \{0\} \cup B \times I)$.*

(ii) *A Serre fibration $p : X \rightarrow Y$ has the lifting property with respect to any relative CW complex (Z, A) for which the inclusion $A \rightarrow Z$ is a weak homotopy equivalence. In particular, if (W, B) is any relative CW complex then p has the lifting property with respect to $(W \times I, W \times \{0\} \cup B \times I)$.*

proof: [157] In both cases we suppose given a commutative square

$$\begin{array}{ccc} A & \xrightarrow{f} & X \\ \downarrow i & & \downarrow p \\ Z & \xrightarrow{\alpha} & Y \end{array}$$

and we have to construct $k : Z \rightarrow X$.

(i) Let $r : Z \rightarrow A$ be a retraction and let $H : Z \times I \rightarrow Z$ be a homotopy rel A from ir to id_Z . Choose a continuous map $h : Z \rightarrow I$ such that $A = h^{-1}(0)$. Define a continuous map $H' : Z \times I \rightarrow Z$ by

$$H'(z, t) = \begin{cases} H(z, t/h(z)) & , \quad t < h(z) \\ z & , \quad t \geq h(z). \end{cases}$$

Then $gH'(z, 0) = gr(z) = pfr(z)$. Thus there is a continuous map $K : Z \times I \rightarrow X$ such that $pK = gH'$ and $K(z, 0) = fr(z)$. Set $k(z) = K(z, h(z))$. For the second assertion apply Proposition 1.9.

(ii) The Whitehead lifting lemma 1.5 provides a retraction $r : Z \rightarrow A$ and a homotopy rel A , $H : Z \times I \rightarrow Z$, from ir to id_Z . Assume $K : Z_{n-1} \times I \rightarrow X$ is defined so that $K(a, t) = f(a)$, $a \in A$, $t \in I$, $K(z, 0) = fr(z)$, $z \in Z_{n-1}$, and $pK = gH$. We extend it to $K : Z_n \times I \rightarrow X$ as follows.

Write $Z_n = Z_{n-1} \cup_q \left(\coprod_{\alpha} D_{\alpha}^n \right)$. We have to fill in the dotted arrows in the commutative solid arrow diagrams

$$\begin{array}{ccc} (S_{\alpha}^{n-1} \times I) \cup (D_{\alpha}^n \times \{0\}) & \xrightarrow{K(q \times id) \cup fr} & X \\ \downarrow & \nearrow \text{dotted } K & \downarrow p \\ D_{\alpha}^n \times I & \xrightarrow{gH} & Y \end{array}$$

But this is possible since $p : X \rightarrow Y$ is a Serre fibration and since $(D^n \times I, S^{n-1} \times I \cup D^n \times \{0\}) \cong (D^n \times I, D^n \times \{0\})$. This constructs a homotopy $K : Z \times I \rightarrow X$. Set $k(z) = K(z, 1)$. □

Fix a Serre fibration

$$F \xrightarrow{j} X \xrightarrow{p} Y$$

in which (X, x_0) is a path connected based space, $y_0 = px_0$ and $F = X_{y_0}$. The homotopy groups of F , X and Y are tightly related, and this is expressed through the natural *connecting homomorphism*

$$\partial : \pi_n(Y, y_0) \rightarrow \pi_{n-1}(F, x_0)$$

which we now describe.

Let $g : (S^n, *) \rightarrow (Y, y_0)$ be a continuous map and, as in Example 5, §1, identify $\Sigma S^{n-1} = S^n$ via the map $\theta : S^{n-1} \times I \rightarrow S^n$. Form the commutative

diagram

$$\begin{array}{ccc}
 S^{n-1} \times \{0\} \cup \{*\} \times I & \xrightarrow{\text{constant map to } x_0} & X \\
 \downarrow i & & \downarrow p \\
 S^{n-1} \times I & \xrightarrow{\theta} S^n \xrightarrow{g} & Y
 \end{array}$$

Since p is a Serre fibration, Proposition 2.1 asserts that $g\theta$ can be lifted through p to a continuous map $H : S^{n-1} \times I \rightarrow X$, which then restricts to a map $h : (S^{n-1}, *) \rightarrow (F, x_0)$.

Proposition 2.2 [93] *With the notation above the correspondence $g \rightsquigarrow h$ defines natural set maps $\partial_n : \pi_n(Y, y_0) \rightarrow \pi_{n-1}(F, x_0)$. When $n \geq 2$, these are group homomorphisms, and fit into a long exact sequence (the long exact homotopy sequence)*

$$\longrightarrow \pi_{n+1}(Y) \xrightarrow{\partial_{n+1}} \pi_n(F) \xrightarrow{\pi_n(j)} \pi_n(X) \xrightarrow{\pi_n(p)} \pi_n(Y) \xrightarrow{\partial_n} \dots$$

When $n = 1$, $\partial_1 : \pi_1(Y) \rightarrow \pi_0(F)$ factors to give a bijection

$$\pi_1(Y) / \text{Im } \pi_1(X) \xrightarrow{\cong} \pi_0(F).$$

proof: Put $W = S^n \times I$ and $B = S^n \times \{0\} \cup \{*\} \times I$. Then the inclusion $W \times \{0, 1\} \cup B \times I \hookrightarrow W \times I$ is a weak homotopy equivalence. Hence it follows from Proposition 2.1(ii) that the based homotopy class of h is independent of the choice of H and depends only on the based homotopy class of g .

Recall from §1 that maps $(S^n, *) \rightarrow (X, x_0)$ may be identified with maps $(I^n, \partial I^n) \rightarrow (X, x_0)$, and that, when $n \geq 1$, composition along the first coordinate defines a second product, $f \tilde{*} g$, such that $f \tilde{*} g \sim f * g \text{ rel } \partial I^n$. But it is immediate from the definition that when $n \geq 2$, $\partial_n[f \tilde{*} g] = [\partial_n f] \tilde{*} [\partial_n g]$; hence ∂_n is a group homomorphism.

The exactness of the sequence and the assertion about ∂_1 are straight forward consequences of the definition and Proposition 2.1(ii). □

Next let

$$\begin{array}{ccc}
 A \times_Y X & \xrightarrow{gx} & X \\
 \downarrow g & & \downarrow p \\
 A & \xrightarrow{g} & Y
 \end{array}$$

be a pullback diagram (i.e., q and g_X are the projections on A and X). Recall that if g is the inclusion of a subspace $A \subset Y$ then g_X is the inclusion of $X_A = p^{-1}(A)$.

Proposition 2.3 *Suppose in the diagram above that p is a fibration.*

(i) *If g is the inclusion of a DR pair (resp. an NDR pair), (Y, A) then (X, X_A) is also a DR pair (resp. an NDR pair).*

(ii) *If g is a homotopy equivalence so is g_X .*

proof: (i) Suppose (Y, A) is a DR pair. Let $H : Y \times I \rightarrow Y$ be a homotopy rel A from id_Y to a retraction $r : Y \rightarrow A$. Let $h : Y \rightarrow I$ be a continuous function such that $h^{-1}(0) = A$ and define a homotopy $H' : X \times I \rightarrow Y$ by

$$H'(x, t) = \begin{cases} H(px, t/h(px)) & , \quad t < h(px) . \\ px & , \quad t \geq h(px) . \end{cases}$$

Lift this to a homotopy $K' : X \times I \rightarrow X$ starting at id_X . Define $K : X \times I \rightarrow X$ by

$$K(x, t) = \begin{cases} K'(x, t) & , \quad t \leq h(px) . \\ K'(x, h(px)) & , \quad t \geq h(px) . \end{cases}$$

Then K exhibits X_A as a strong deformation retract of X . Thus K together with $k = h \circ p$ exhibits (X, X_A) as a DR pair.

An identical argument shows that if (Y, A) is an NDR pair then so is (X, X_A) .

(ii) Regard g as a map $A \times \{0\} \rightarrow Y$, and let $r : (A \times I) \cup_g Y \rightarrow Y$ be the retraction sending (a, t) to ga . Denote $(A \times I) \cup_g Y$ by Z and form the pullback diagram

$$\begin{array}{ccc} Z \times_Y X & \xrightarrow{r_X} & X \\ \downarrow p_Z & & \downarrow p \\ Z & \xrightarrow{r} & Y \end{array}$$

Now identify $A = A \times \{1\} \subset Z$. Then the inclusion of A in Z is a homotopy equivalence, because g is, while the inclusion of Y in Z is obviously a homotopy equivalence. Since (Z, A) and (Z, Y) are clearly NDR pairs, Proposition 1.11 asserts they are NR pairs. Now assertion (i) of this proposition implies that $(Z \times_Y X, A \times_Y X)$ and $(Z \times_Y X, Y \times_Y X)$ are DR pairs. But $Y \times_Y X = X$ and $r_X : Z \times_Y X \rightarrow X$ is a left inverse for the inclusion. Hence r_X is a homotopy equivalence. Moreover, g_X factors as $A \times_Y X \rightarrow Z \times_Y X \xrightarrow{r_X} X$, and so it is a homotopy equivalence too. \square

Finally, let

$$\begin{array}{ccc} X' & \xrightarrow{f} & X \\ p' \downarrow & & \downarrow p \\ Y' & \xrightarrow{g} & Y' \end{array}$$

be a fibre preserving map between Serre fibrations with path connected total spaces. Then from Proposition 2.2 and the five lemma (see Lemma 3.1) we deduce

Proposition 2.4 *Let $y' \in Y'$ be any basepoint. If any two of the maps f , g and $f_{y'} : X'_{y'} \rightarrow X_{gy'}$ are weak homotopy equivalences, then so is the third. \square*

(b) Topological monoids and G -fibrations.

A *topological monoid* is a topological space G equipped with a continuous, associative multiplication $\mu : G \times G \rightarrow G$ and a two sided identity $e \in G$. A (*right*) *action of G* on a space P is a continuous map $P \times G \rightarrow P$, $(z, g) \mapsto z \cdot g$, such that $z \cdot e = z$ and $(z \cdot g_1) \cdot g_2 = z \cdot (g_1 g_2)$, for $z \in P$ and $g, g_1, g_2 \in G$. Suppose $P' \times G' \rightarrow P'$ is a right action of a second topological monoid G' . Then an *equivariant map* consists of a morphism $\gamma : G \rightarrow G'$ of topological monoids and a continuous map $f : X \rightarrow X'$ such that $f(x \cdot a) = f(x) \cdot \gamma(a)$. If f and γ are weak homotopy equivalences then (f, γ) is called an *equivariant weak equivalence*.

Definition A G -(*Serre*) *fibration* is a (Serre) fibration $p : P \rightarrow X$ together with a right action $P \times G \rightarrow P$ such that

- (i) $p(z \cdot g) = pz$, $z \in P$, $g \in G$, and
- (ii) For each $z \in P$ the map $A_z : G \rightarrow P_{pz}$ sending $g \mapsto z \cdot g$ is a weak homotopy equivalence.

Remark 1 If P is path connected and some A_z is a weak homotopy equivalence then so is every A_w , $w \in P$. Indeed, join z and w by a path $\sigma : I \rightarrow P$. Then we have a map of fibrations

$$\begin{array}{ccc} I \times G & \xrightarrow{f} & I \times_X P \\ \text{proj} \searrow & & \swarrow \text{proj} \\ & I & \end{array} \quad , \quad f(t, g) = (t, \sigma(t) \cdot g).$$

Let f_t be the restriction of f to the fibres at t . Then Proposition 2.3 asserts that

$$\begin{aligned} f_0 \text{ is a weak homotopy equivalence} & \iff f \text{ is a weak homotopy equivalence} \\ & \iff f_1 \text{ is a weak homotopy equivalence} \end{aligned}$$

But $f_0 = A_z$ and $f_1 = A_w$.

Remark 2 If $f : Y \rightarrow X$ is a continuous map the pullback $Y \times_X P \rightarrow Y$ of a G - (Serre) fibration is again a G - (Serre) fibration with action $(y, z) \cdot g = (y, zg)$, $y \in Y, z \in P, g \in G$.

Example 1 *Path space fibrations.*

As usual, X^Y denotes the space of all continuous maps $Y \rightarrow X$. In particular, let $\widehat{P}(X, x_0) \subset X^I$ be the subspace of paths ending at x_0 , and let $\widehat{\Omega}(X, x_0) \subset \widehat{P}(X, x_0)$ be the subspace of paths beginning and ending at x_0 . Then it follows easily from the exponential law that

$$\widehat{\Omega}(X, x_0) \longrightarrow \widehat{P}(X, x_0) \xrightarrow{p} X, \quad p : \gamma \longmapsto \gamma(0),$$

is a fibration, and that $\widehat{P}X$ is contractible. Note also that a continuous multiplication in $\widehat{\Omega}X$ is defined by

$$(\gamma, \omega) \longmapsto \gamma * \omega, \quad (\gamma * \omega)(t) = \begin{cases} \gamma(2t) & 0 \leq t \leq \frac{1}{2} \\ \omega(2t - 1) & \frac{1}{2} \leq t \leq 1. \end{cases}$$

This is ‘homotopy associative’, but not associative. These constructions are the classical version of the path space fibration and the loop space for X . It turns out to be highly convenient to use instead Moore’s version of the path space fibration and loop space, since the latter is a genuine topological monoid.

Thus a *Moore path* in X is a pair (γ, ℓ) in which $\gamma : [0, \infty) \rightarrow X$ is a continuous map, $\ell \in [0, \infty)$, and $\gamma(t) = \gamma(\ell)$ for $t \geq \ell$. The path *starts* at $\gamma(0)$, *ends* at $\gamma(\ell)$ and has *length* ℓ . The space $MX \subset X^{[0, \infty)} \times [0, \infty)$ of all Moore paths is the *free Moore path space* on X . The *Moore path space* $P(X, x_0) \subset MX$ is the subspace of all Moore paths ending at x_0 and the *Moore loop space* $\Omega(X, x_0)$ is the subspace of all Moore paths starting and ending at x_0 . As above, we usually abuse notation and write simply ΩX and PX . We may also abuse notation and denote (γ, ℓ) simply by γ . From the exponential law it follows easily [157] that if X is path connected then

$$\Omega X \longrightarrow PX \xrightarrow{p} X \quad p(\gamma, \ell) = \gamma(0)$$

is a fibration and that PX is contractible. This is called the *Moore path space fibration* for (X, x_0) . Note that $\widehat{\Omega}X$ and $\widehat{P}X$ can be identified as the subspaces of ΩX and PX of paths of length one, and that these inclusions are homotopy equivalences.

If $\gamma \in PX$ and $\omega \in \Omega X$ are paths of lengths ℓ and r we define their product to be the path $\gamma * \omega$ of length $\ell + r$ given by

$$(\gamma * \omega)(t) = \begin{cases} \gamma(t), & 0 \leq t \leq \ell \\ \omega(t - \ell), & \ell \leq t. \end{cases}$$

This product, restricted to $\Omega X \times \Omega X$, makes ΩX into a topological monoid with identity the constant loop of length 0 at x_0 . It is called the *Moore loop space of X at x_0* .

The original map, $PX \times \Omega X \rightarrow PX$ is a continuous right action of the monoid ΩX on the contractible space PX . Note that $p(\gamma * \omega) = p\gamma$, $\gamma \in PX$, $\omega \in \Omega X$. Moreover ΩX is the fibre $(PX)_{x_0}$ and the map $A_e : \Omega X \rightarrow (PX)_{x_0}$ is just the identity, and so a weak homotopy equivalence. Thus it follows from Remark 1 that the Moore path space fibration $PX \xrightarrow{p} X$ is an ΩX -fibration.

We shall often abuse language and refer to PX and ΩX simply as the *path space and loop space of X* . Finally, if $f : (X, x_0) \rightarrow (Y, y_0)$ is any continuous map then $\Omega f : \gamma \mapsto f \circ \gamma$ defines a morphism of topological monoids,

$$\Omega f : \Omega X \rightarrow \Omega Y.$$

□

In particular, suppose $F \xrightarrow{j} X \xrightarrow{p} Y$ is a fibration with path connected base, Y and path connected fibre, F . Choose basepoints $y_0 \in Y$, $x_0 \in X$ and $z_0 \in F$ so that $F = X_{y_0}$ and $j(z_0) = x_0$. It follows easily from the exponential law and Proposition 2.1 that $\Omega X \xrightarrow{\Omega p} \Omega Y$ is a fibration with fibre ΩF . Moreover the multiplication in ΩX restricts to an action of ΩF on ΩX , and so the pair

$$\Omega X \xrightarrow{\Omega p} \Omega Y, \quad \Omega X \times \Omega F \rightarrow \Omega X$$

is an ΩF -fibration.

(c) The homotopy fibre and the holonomy fibration. Let $f : X \rightarrow Y$ be a continuous map between path connected spaces and let $q_0, q_1 : MY \rightarrow Y$ denote the maps $(\gamma, \ell) \mapsto \gamma(0)$ and $(\gamma, \ell) \mapsto \gamma(\ell)$. Let c_y be the path of length 0 at y . Form the commutative diagram

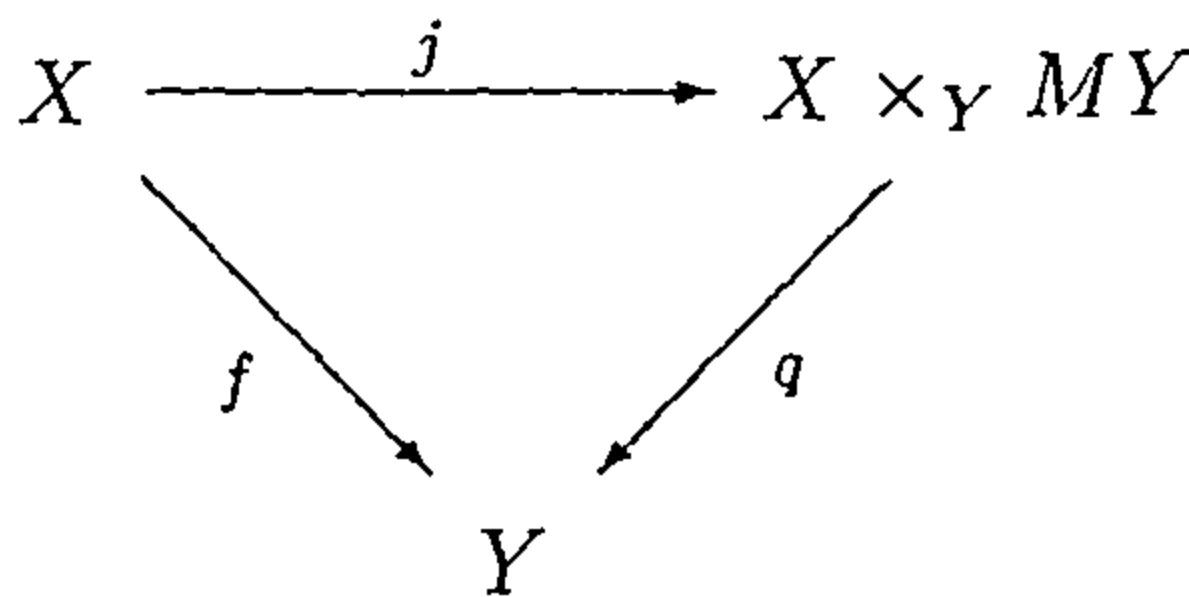

, where

- $X \times_Y MY$ is the fibre product with respect to f and q_0
- $j(x) = (x, c_{f_x})$
- $q(x, \gamma) = q_1(\gamma)$.

It is easy to verify that j is a homotopy equivalence and q is a fibration: we say the *diagram converts f into the fibration q* .

Fix a basepoint $y_0 \in Y$. The fibre of q at y_0 is $X \times_Y PY$. It is called the *homotopy fibre of f* . Clearly the action of ΩY on PY defined above defines an action of ΩY on the homotopy fibre. Moreover the diagram

$$\begin{array}{ccc} X \times_Y PY & \longrightarrow & PY \\ p \downarrow & & \downarrow \\ X & \longrightarrow & Y \end{array}, \quad p = \text{projection on the first factor,}$$

exhibits p as a pull back ΩY -fibration. It is called the *holonomy fibration* associated with the continuous map $f : X \rightarrow Y$.

Let $\pi : X \times_Y MY \rightarrow X$ be the projection; it is a homotopy equivalence inverse to j . The commutative diagram

$$\begin{array}{ccccc}
 X \times_Y PY & \xrightarrow{i} & X \times_Y MY & \xrightarrow{q} & Y \\
 \searrow p & & \swarrow \pi \simeq & & \swarrow f \\
 & & X & & X \\
 & & \swarrow j \simeq & & \searrow f \\
 & & & & Y
 \end{array}$$

identifies p with i and f with q , ‘up to homotopy’. Thus the long exact homotopy sequence for the fibration q translates to a long exact sequence

$$\cdots \rightarrow \pi_n(X \times_Y PY) \xrightarrow{\pi_n(p)} \pi_n(X) \xrightarrow{\pi_n(f)} \pi_n(Y) \xrightarrow{\partial} \pi_{n-1}(X \times_Y PY) \rightarrow \cdots$$

Finally, write $F = f^{-1}(y_0)$. Then j restricts to an inclusion $j_0 : F \rightarrow X \times_Y PY$.

Proposition 2.5

- (i) If p is a fibration then $(X \times_Y PY, F)$ is a DR pair. In particular, j_0 is a homotopy equivalence.
- (ii) If p is a Serre fibration then j_0 is a weak homotopy equivalence.

proof: (i) Define a commutative square of continuous maps

$$\begin{array}{ccc}
 X \times_Y PY \times \{0\} & \xrightarrow{p} & X \\
 \downarrow & & \downarrow f \\
 X \times_Y PY \times [0, \infty) & \xrightarrow{\varphi} & Y
 \end{array}$$

by setting $\varphi(x, \gamma, t) = \gamma(t)$. Lift φ to a continuous map $\Phi : X \times_Y PY \times [0, \infty) \rightarrow X$ so that $p\Phi = \varphi$ and $\Phi(x, \gamma, 0) = x$.

Then a homotopy $H : X \times_Y PY \times I \rightarrow X \times_Y PY$ is given by

$$H(x, \gamma, t) = (\Phi(x, \gamma, t\ell_\gamma), \gamma_t)$$

where ℓ_γ is the length of γ and γ_t is the path of length $(1-t)\ell_\gamma$ given by $\gamma_t(s) = \gamma(t\ell_\gamma + s)$. Clearly H is a homotopy rel F from the identity to a retraction $X \times_Y PY \rightarrow F$. Finally, if $h : X \times_Y PY \rightarrow I$ is defined by $h(x, \gamma) = \inf(1, \ell_\gamma)$ then $h^{-1}(0) = F$.

(ii) This follows immediately from Proposition 2.3 since j is a homotopy equivalence. □

On the other hand, we can exhibit the homotopy fibre F_f of $f : X \rightarrow Y$ as the analogue of a homogeneous space. Let $P'X \subset MX$ be the subspace of Moore paths (γ, ℓ) that *begin* at the basepoint $x_0 : \gamma(0) = x_0$. Multiplication of paths defines a *left* action of ΩX on $P'X$ and the projection

$$\varrho : P'X \times_X F_f \rightarrow F_f \quad \varrho(\gamma, z) \mapsto z$$

is a (left) ΩX -fibration.

Let c_X and c_Y denote the constant paths of length zero at the basepoints x_0 and $y_0 = fx_0$. Then ΩX is the actual fibre of ϱ at the basepoint (x_0, c_Y) of F_f and the fibre inclusion is given by

$$\lambda : \Omega X \rightarrow P'X \times_X F_f, \quad \lambda : \gamma \mapsto (\gamma * c_X, x_0, c_Y).$$

Thus we may regard F_f as the ‘quotient’ of $P'X \times_X F_f$ by the topological monoid ΩX .

Now recall that $F_f = X \times_Y PY$. Thus $P'X \times_X F_f = P'X \times_X X \times_Y PY$. Define a continuous map

$$\eta : P'X \times_X F_f \rightarrow \Omega Y \quad \text{by } \eta(\gamma, x, \omega) = (f\gamma) * \omega.$$

We show that η has the following properties:

- η is a homotopy equivalence.
- $\eta(\gamma \cdot z) = (\Omega f)\gamma * \eta z, \quad \gamma \in \Omega X, z \in P'X \times_X F_f.$
- The diagram

$$\begin{array}{ccc} \Omega X & \xrightarrow{j} & P'X \times_X F_f \\ & \searrow \Omega f & \swarrow \simeq \eta \\ & & \Omega Y \end{array}$$

commutes.

Thus ‘up to homotopy equivalence’ the ΩX -spaces $P'X \times_X F_f$ and ΩY coincide and so F_f may be thought of as the quotient of ΩY by ΩX .

Of the three properties listed for η the last two are immediate consequences of the definition. For the first, notice that $P'X \times_X X \times_Y PY = P'X \times_Y PY$ and that the projection on the first factor is a fibration $P'X \times_Y PY \rightarrow P'X$, with fibre ΩY . Since $P'X$ is contractible the inclusion $\xi : \Omega Y \rightarrow P'X \times_Y PY$ of the fibre is a homotopy equivalence. But $\eta\xi = \text{identity}$ and so η is a homotopy equivalence too.

(d) Fibre bundles and principal bundles.

A *product bundle with fibre* Z is a continuous map $p : X \rightarrow Y$ for which there is a homeomorphism $g : Y \times Z \xrightarrow{\cong} X$ such that $pg(y, z) = y$. A *fibre bundle with*

fibre Z is a continuous map $p : X \rightarrow Y$ such that Y is covered by open sets O_i and the restrictions $p_i : p^{-1}(O_i) \rightarrow O_i$ are product bundles with fibre Z . If $p : X \rightarrow Y$ is a fibre bundle and $f : A \rightarrow Y$ is any continuous map then the pullback $A \times_Y X \rightarrow A$ is also a fibre bundle.

Proposition 2.6 *A fibre bundle is a Serre fibration.*

proof: First note that if a continuous surjection $p : X \rightarrow Y$ has the lifting property with respect to $(I^n \times I, I^n \times \{0\})_{n \geq 0}$, then it is a Serre fibration. Indeed, suppose given a relative CW complex (W, A) and a homotopy $g : W \times I \rightarrow Y$. Note that $(D^n \times I, S^{n-1} \times I \cup D^n \times \{0\}) \cong (I^n \times I, I^n \times \{0\})$. Thus if $f : W \times \{0\} \cup A \times I \rightarrow X$ satisfies $pf = g$ we may extend f , one cell at a time, to a lift of g .

Suppose now that $p : X \rightarrow Y$ is a fibre bundle and we want to lift $g : I^{n+1} \rightarrow Y$ through p extending $f : I^n \times \{0\} \rightarrow X$. Use the pullback over g to reduce to the case $Y = I^{n+1}$, $g = \text{identity}$. Recall (§1) that a subdivision of I gives a product cellular structure for I^{n+1} . Choose the subdivision sufficiently fine that each ‘little cell’ is contained in an open set over which the fibre bundle is trivial. Then the restriction to each cell is a Serre fibration and the construction of the lift g , one cell at a time, is immediate. \square

Now consider the following situation:

- $p : X \rightarrow Y$ is a continuous map.
- Y is a CW complex with characteristic maps $F_\alpha : D_\alpha^n \rightarrow Y_n$.
- The pullbacks $D_\alpha^n \times_Y X \rightarrow D_\alpha^n$ (all α, n) are product bundles with common fibre Z .

Proposition 2.7 *With the hypotheses above $p : X \rightarrow Y$ is a fibre bundle with fibre Z . In particular it is a Serre fibration.*

proof: For each k , the characteristic maps define a homeomorphism $\coprod_\beta (D_\beta^k - S_\beta^{k-1}) \xrightarrow{\cong} Y_k - Y_{k-1}$. Thus the restriction $p : p^{-1}(Y_k - Y_{k-1}) \rightarrow Y_k - Y_{k-1}$ is a product bundle over the open subset $Y_k - Y_{k-1}$ of Y_k .

Suppose now by induction that we have extended this to an open set $U \subset Y_{n-1}$ and a homeomorphism $h_U : U \times Z \xrightarrow{\cong} p^{-1}(U)$ such that $ph_U(u, z) = u$. We shall extend U to an open subset $V \subset Y_n$ and h_U to a homeomorphism $h_V : V \times Z \xrightarrow{\cong} p^{-1}(V)$ such that $ph_V(v, z) = v$.

For simplicity put $D = \coprod_\alpha D_\alpha^n$ and $S = \coprod_\alpha S_\alpha^{n-1}$ and write $Y_n = Y_{n-1} \cup_f D$ where $f : S \rightarrow Y_{n-1}$ is the attaching map. Then identify $D_\alpha^n - \{o_\alpha\} = S_\alpha^{n-1} \times (0, 1]$, with $\{o_\alpha\}$ the origin of D_α^n and S_α^{n-1} identified with $S_\alpha^{n-1} \times \{1\}$. Thus

$D - \coprod \{o_\alpha\} = S \times (0, 1]$ and $V = U \cup_f (f^{-1}(U) \times (0, 1])$ is an open set of Y_n extending U .

Next we undertake the extension of h_U to h_V . The hypothesis above provides a homeomorphism $\theta : D \times Z \xrightarrow{\cong} D \times_Y X$, compatible with the projections on D . Moreover h_U pulls back to the homeomorphism $h_f : f^{-1}(U) \times Z \xrightarrow{\cong} f^{-1}(U) \times_Y X$ given by $h_f(w, z) = (w, h(fw, z))$. Thus $\theta^{-1} \circ h_f$ is a self homeomorphism of $f^{-1}(U) \times Z$ of the form $(w, z) \mapsto (w, \varphi(w, z))$. Extend this to the homeomorphism

$$\theta_f : f^{-1}(U) \times (0, 1] \times Z \xrightarrow{\cong} (f^{-1}(U) \times (0, 1]) \times_Y X$$

given by $\theta_f(w, t, z) = \theta((w, t), \psi(w, z))$.

The homeomorphisms h_U and θ_f are compatible and so define a unique set theoretic bijection h_V making the following diagram commute:

$$\begin{array}{ccc} (U \amalg f^{-1}(U) \times (0, 1]) \times Z & \xrightarrow{(h_U, \theta_f)} & (U \times_Y X) \amalg ((f^{-1}(U) \times (0, 1]) \times_Y X) \\ \downarrow q \times id & & \downarrow q' \\ V \times Z & \xrightarrow{h_V} & p^{-1}(V) \end{array}$$

in which q is the obvious quotient map and q' is projection on X . Since h_U and θ_f are homeomorphisms we need only verify that $q \times id$ and q' are quotient maps to conclude that h_V is a homeomorphism too.

Since q is a quotient map so is the product $q \times id$. To consider q' write $A = F(f^{-1}(U) \times (0, 1])$. Then U and A are closed in V and $V = U \cup A$. Since $q' = id : U \times_Y X \xrightarrow{\cong} p^{-1}(U)$ it is enough to show that $q' : (f^{-1}(U) \times (0, 1]) \times_Y X \rightarrow p^{-1}(A)$ is a quotient map. Because we work with k -spaces this reduces to the assertion: if $B \subset K^{\text{compact}} \subset p^{-1}(A)$ and if $(q')^{-1}(B)$ is closed, then B is closed.

But the compact set $p(K)$ is covered by finitely cells $F_{\alpha_i}(D_{\alpha_i}^n)$, $1 \leq i \leq N$. Put $C = \bigcup_{i=1}^N F_{\alpha_i}^{-1}(pK)$. Thus C and hence $C \times_Y K$ are compact. Since $p(K) \subset A$, $C \subset f^{-1}(U) \times (0, 1]$. Thus $(q')^{-1}(B) \cap (C \times_Y K)$ is compact. A simple check shows that $B = q'((q')^{-1}(B) \cap C \times_Y K)$. Thus B is compact, and so closed in $p^{-1}(A)$. This completes the proof that q' is a quotient map and hence shows that h_V is indeed a homeomorphism.

This inductive construction leads to a subset $O \subset Y$ and a bijection $h : O \times Z \rightarrow p^{-1}(O)$ with the following properties:

- $O \cap Y_k = Y_k - Y_{k-1}$.
- for $n \geq k$, $O_n = O \cap Y_n$ is open in Y_n .

... $\cap \dots \cap p^{-1}(O_n)$ is a homeomorphism.

Thus O is open in Y . Moreover, since any compact subspace of Y is contained in some Y_n (Proposition 1.1(ii)) it follows that $C \subset O \times Z$ is compact if and only if $h(C)$ is compact and that $h : C \xrightarrow{\cong} h(C)$. This implies (because we work in the category of k -spaces) that h is a homeomorphism. \square

We turn now to the definition of topological groups and principal (fibre) bundles, which are important special cases of topological monoids G and G -Serre fibrations.

A *topological group* is a topological monoid G such that the monoid is a group and the map $g \mapsto g^{-1}$ is continuous. If the topological group G acts continuously on a topological space X then X is the disjoint union of the *orbits* $x \cdot G$, and the *orbit space* X/G is the set of orbits equipped with the quotient topology. (We only consider cases where X/G is Hausdorff.)

Let G be a topological group. A *principal G -bundle* is a continuous map $p : X \rightarrow Y$ together with an action of G on X such that Y is covered by open sets O_α and there are continuous maps $\sigma_\alpha : O_\alpha \rightarrow X$ with the following properties:

- $p\sigma_\alpha = id$
- A homeomorphism $O_\alpha \times G \xrightarrow{\cong} p^{-1}(O_\alpha)$ is given by $(y, g) \mapsto \sigma_\alpha(y) \cdot g$.

In this case $p : X \rightarrow Y$ is a fibre bundle with typical fibre G , the orbits of G are the fibres of p and p induces a homeomorphism $X/G \xrightarrow{\cong} Y$. In particular, $p : X \rightarrow Y$ is a G -Serre fibration.

Now consider the following situation:

- $p : X \rightarrow Y$ is a continuous map and $X \times G \rightarrow X$ is a continuous action of a topological group G .
- Y is a CW complex with characteristic maps $F_\alpha : D_\alpha^n \rightarrow Y_n$.
- There are continuous maps $\sigma_\alpha : D_\alpha^n \rightarrow D_\alpha^n \times_Y X$ (all n, α) such that σ_α has the form $\sigma_\alpha(w) = (w, \varphi_\alpha(w))$ and

$$D_\alpha^n \times G \xrightarrow{\cong} D_\alpha^n \times_Y X, \quad (w, g) \mapsto \sigma_\alpha(w) \cdot g$$

is a homeomorphism.

Proposition 2.8 . *With the hypotheses above $p : X \rightarrow Y$ is a principal G -bundle.*

proof: It follows from Proposition 2.7 that $p : X \rightarrow Y$ is a fibre bundle. Thus Y is covered by open sets U_i for which there are continuous maps $\tau_i : U_i \rightarrow X$ such that $p\tau_i = id$. We have only to check that the continuous maps $h_i : U_i \times G \rightarrow p^{-1}(U_i)$, $(u, g) \mapsto \tau_i(u) \cdot g$, are homeomorphisms.

It is immediate from the hypotheses above that h_i is a bijection. Thus it is sufficient to show that $h_i^{-1}(C)$ is compact for any compact subspace $C \subset p^{-1}(U_i)$. Since $p(C)$ is covered by finitely many cells (Proposition 1.1(ii)) this too follows easily from the hypotheses. \square

(e) Associated bundles, classifying spaces, the Borel construction and the holonomy fibration.

Suppose given a principal G -bundle $p : X \rightarrow Y$ and an action of G on a third topological space Z . Then G acts *diagonally* on $X \times Z : (x, z) \cdot g = (xg, zg)$. Consider the continuous maps

$$X \times Z \xrightarrow{\rho} (X \times Z)/G \xrightarrow{q} Y$$

where q is the map of orbit spaces induced by the projection $X \times Z \rightarrow X$. It is an easy exercise to check that ρ is the projection of a principal G -bundle and that q is the projection of a fibre bundle with typical fibre Z : this fibre bundle is called *the fibre bundle associated to the principal bundle via the action of G on Z* .

Central to the study of principal G -bundles is Milnor's universal G -bundle [125]

$$p_G : E_G \rightarrow B_G$$

constructed as follows.

Recall (§1(f)) that $C_G = (G \times I)/G \times \{0\}$ is the cone on G , and that the n^{th} join, G^{*n} , is the subspace of $C_G \times \cdots \times C_G$ of points $((g_0, t_0), \dots, (g_n, t_n))$ such that $\sum t_i = 1$. Thus $G^{*n} \subset G^{*(n+1)}$ (inclusion opposite the base point of C_G). Set $E_G = \bigcup_n G^{*n}$, equipped with the weak topology determined by the G^{*n} .

A continuous action of G in E_G is given by

$$((g_0, t_0), \dots, (g_n, t_n)) \cdot g = ((g_0g, t_0), \dots, (g_ng, t_n)).$$

Set $B_G = E_G/G$ and let $p_G : E_G \rightarrow B_G$ be the quotient map. It is an easy exercise to verify that

- $p_G : E_G \rightarrow B_G$ is a principal G -bundle.
- every continuous map from a compact space to E_G is homotopic to a constant map. In particular, $\pi_*(E_G) = 0$.

The space B_G is called the *classifying space* of G . Now associated with an arbitrary action of G on a topological space X are two important constructions: the *Borel construction* and the *loop construction*.

The *Borel construction* is the fibre bundle

$$q : X_G = (E_G \times X)/G \rightarrow B_G$$

with typical fibre X , associated to the universal bundle via the action of G on

Proposition 2.9 *If $p : X \rightarrow Y$ is a principal G -bundle then there is a weak homotopy equivalence $X_G \xrightarrow{\cong} Y$.*

proof: The associated fibre bundle with fibre E_G has the form

$$q' : X_G = (E_G \times X) / G \rightarrow Y.$$

Since $\pi_*(E_G) = 0$ and since this is a Serre fibration, the long exact homotopy sequence shows that q' is a weak homotopy equivalence. \square

Consider a principal G -bundle $p : X \rightarrow Y$ whose base Y is a CW complex. Because $q' : X_G \rightarrow Y$ is a weak homotopy equivalence there is a map $\sigma' : Y \rightarrow X_G$ such that $q'\sigma' \sim id$ (Whitehead Lifting Lemma 1.4). Because q' is a Serre fibration we can lift the homotopy starting at σ' to obtain a homotopy $\sigma' \sim \sigma : Y \rightarrow X_G$ with $q'\sigma = id$. This identifies Y as a subspace of X_G .

Restrict the principal G -bundle $E_G \times X \rightarrow X_G$ to a principal bundle $P \rightarrow Y$. Projection $E_G \times X \rightarrow X$ restricts to a map $P \rightarrow X$ of principal bundles covering the identity map of Y . This map is therefore a homeomorphism, which we use to identify $P \cong X$.

Thus the diagram

$$\begin{array}{ccccc}
 X & \longrightarrow & E_G \times X & \xrightarrow{\text{proj}} & E_G \\
 \downarrow p & & \downarrow & & \downarrow p_G \\
 Y & \xrightarrow{\sigma} & X_G & \xrightarrow{q} & B_G
 \end{array}$$

exhibits the original principal bundle as a pullback of Milnor's universal bundle (whence the name). An extension of this argument shows that the pullback construction defines a bijection

$$[Y, B_G] \xrightarrow{\cong} \left\{ \begin{array}{l} \text{isomorphism classes of principal} \\ G\text{-bundles over } Y \end{array} \right\},$$

thereby explaining the terminology 'classifying space' for B_G .

Finally, suppose a topological monoid G acts on a path connected space X with basepoint x_0 . Then, as described in §2(c), the continuous map $a : G \rightarrow X, a : g \mapsto x_0 \cdot g$, can be converted into the fibration $G \times_X PX \rightarrow G \times_{\tilde{X}} MX \rightarrow X$. Moreover, this is homotopy equivalent to

$$G \times_X PX \xrightarrow{\rho} G \xrightarrow{a} X$$

where ρ is the projection of an ΩX -fibration.

Now we show that $G \times_X PX$ is a topological monoid and that ρ is a morphism of topological monoids. Thus X may be thought of as a sort of 'generalized

homogeneous space'. To construct the multiplication on $G \times_X PX$ let G act on MX by $(w \cdot g)(t) = w(t) \cdot g$, $w \in MX$, $g \in G$. Then set

$$(g, w) \cdot (g', w') = (gg', (w \cdot g') * w'),$$

where, as usual, $*$ denotes composition of paths. The pair (e_G, c_{x_0}) is a two sided identity. We call the monoid $G \times_X PX$ the *loop construction at x_0* corresponding to the action of G on X .

In particular, suppose given an arbitrary principal G fibre bundle

$$Z \xrightarrow{p_B} B, \quad Z \times G \rightarrow Z$$

in which $\pi_*(Z) = 0$. Then morphisms of topological monoids

$$G \xleftarrow{\gamma} G \times_Z PZ \xrightarrow{\gamma'} \Omega B$$

are defined by $\gamma(g, w) = g$ and $\gamma'(g, w) = p_B \circ w$.

Proposition 2.10 *γ and γ' are weak homotopy equivalences, so that G and ΩB are weakly equivalent topological monoids.*

proof: Define an action of $G \times_Z PZ$ on PZ by setting $u \cdot (g, w) = (u \cdot g) * w$. Then $\pi : PZ \rightarrow B$, $\pi(w) = p_B(w(0))$, is a $G \times_Z PZ$ -fibration. It fits in the diagram of fibrations

$$\begin{array}{ccccc} Z & \xleftarrow{f} & PZ & \xrightarrow{f'} & PB \\ & \searrow p_B & \downarrow \pi & \swarrow \varrho & \\ & & B & & \end{array}$$

where $f(w) = w(0)$ and $f'(w) = p_B \circ w$. Moreover f and f' restrict to γ and γ' respectively in the fibres. Since π_* vanishes on Z , PZ and PB , it follows from the long exact homotopy sequence that γ and γ' are weak homotopy equivalences. \square

Observe that in the proof of Proposition 2.10 that (f, γ) and (f', γ') are *equivariant weak equivalences*.

Again let $p : Z \rightarrow B$ be the principal G -bundle described just before Proposition 2.10. If $\varphi : Y \rightarrow B$ is any continuous map we can form the pullback principal bundle

$$p : Y \times_B Z \rightarrow Y, \quad (Y \times_B Z) \times G \rightarrow Y \times_B Z$$

and also the holonomy fibration (§2(c)),

$$o : Y \times_B PB \rightarrow Y, \quad (Y \times_B PB) \times \Omega B \rightarrow Y \times_B PB.$$

The diagram of Proposition 2.10 pulls back to the diagram of Serre fibrations

$$\begin{array}{ccccc}
 Y \times_B Z & \xleftarrow{Y \times_B f} & Y \times_B PZ & \xrightarrow{Y \times_B f'} & Y \times_B PB \\
 & \searrow & \downarrow & \swarrow & \\
 & & Y & &
 \end{array}$$

which identifies $Y \times_B f$ and $Y \times_B f'$ as equivariant weak equivalences. This extends Proposition 2.10 to

Proposition 2.11 *The pullback fibre bundle $p : Y \times_B Z \rightarrow Y$ and the holonomy fibration of φ are connected by equivariant weak equivalences of fibrations:*

$$\begin{array}{ccc}
 Y \times_B Z & \xleftarrow{\quad} \bullet & \xrightarrow{\quad} Y \times_B PB \\
 & \searrow & \swarrow \\
 & & Y
 \end{array}
 , \quad G \leftarrow \bullet \rightarrow \Omega B .$$

□

Exercises

1. Let F be the homotopy fiber of the inclusion $i : X \vee Y \rightarrow X \times Y$. Prove that $F \simeq \Omega X * \Omega Y$ and that Ωi is a ΩF -fibration with a cross section. Assume that X and Y are simply connected CW complexes. Prove that $\Omega(X \vee Y)$ is weakly homotopy equivalent to the product $\Omega X \times \Omega Y \times \Omega F$. Deduce that if X (resp. Y) is r (resp. s) connected then $\pi_k(X \vee Y) = \pi_k(X) \oplus \pi_k(Y)$ for $k \leq r + s - 2$.
2. Let X be a locally compact space and $A \hookrightarrow X$ a closed cofibration. Prove that the canonical map $Y^X \rightarrow Y^A$ is a fibration.
3. Prove that $p : B^I \rightarrow B \times B = B^{\partial I}$, $f \mapsto (f(0), f(1))$ is a fibration. Prove that $q : B^{S^1} \rightarrow B$, $q(\gamma) = \gamma(0)$ is the pull-back fibration of $p : B^I \rightarrow B \times B$ along the diagonal map $B \rightarrow B \times B$. Deduce that $\pi_k(B^{S^1}) = \pi_k(B) \oplus \pi_{k+1}(B)$, $k \geq 1$.
4. Let $f : S^n \rightarrow S^n$ be a homeomorphism of degree -1 and E the quotient space of the product $S^n \times [0, 1]$ by the relation $(x, 0) \sim (f(x), 1)$. Prove that the composite $S^n \times [0, 1] \rightarrow [0, 1] \rightarrow S^1$ induces a fibration $p : E \rightarrow S^1$. For $n \geq 2$, compute $\pi_k(E)$ and the action of ΩS^1 on the homotopy fibre $F_p \simeq S^n$.
5. Prove that if X and Y are simply connected CW complexes then the homotopy fibre of the pinch map $X \vee Y \rightarrow X$ is the half-smash product $Y \times \Omega X / * \times \Omega X$.

3 Graded (differential) algebra

In this section we work over an arbitrary commutative ground ring \mathbb{k} , except in (e). Thus module, linear, bilinear, ... will mean \mathbb{k} -module, \mathbb{k} -linear, \mathbb{k} -bilinear, ... and the functors $\text{Hom}_{\mathbb{k}}(-, -)$ and $- \otimes_{\mathbb{k}} -$ will be denoted simply by $\text{Hom}(-, -)$ and $- \otimes -$.

The object of this section is to establish the basic definitions and conventions of graded algebra upon which the rest of this book will rely. It is organized into the topics:

- (a) Graded modules and complexes.
- (b) Graded algebras.
- (c) Differential graded algebras.
- (d) Graded coalgebras.
- (e) When \mathbb{k} is a field.

(a) Graded modules and complexes.

A *graded module* V , is a family $\{V_i\}_{i \in \mathbb{Z}}$ of modules. By 'abuse of language' we say that an element $v \in V_i$ is *an element of V of degree i* , and we write $|v| = \deg v = i$. We say that V is *concentrated in degrees $i \in I$* if $V_i = 0$, $i \notin I$, and, by abuse of notation, we write $V = \{V_i\}_{i \in I}$. In particular we write $V_{\text{even}} = \{V_{2i}\}_{i \in \mathbb{Z}}$ and $V_{\text{odd}} = \{V_{2i+1}\}_{i \in \mathbb{Z}}$.

Notice that we make frequent use of the **Koszul sign convention** that when two symbols of degrees k and ℓ are permuted the result is multiplied by $(-1)^{k\ell}$.

The standard notions for non-graded modules carry over to the graded context:

- A *submodule* $V' \subset V$ is a graded module $\{V'_i\}$ with $V'_i \subset V_i$.
- The *quotient* V/V' of a module by a submodule is the family $\{V_i/V'_i\}$.
- The *direct sum* $\bigoplus_{\alpha} V(\alpha)$ is the family $\{\bigoplus_{\alpha} V(\alpha)_i\}$. In particular if $V(i)$ is the graded module defined by

$$V(i)_j = \begin{cases} V_i & , j = i \\ 0 & , \text{otherwise} \end{cases}$$

then $V = \bigoplus_i V(i)$. We shall therefore sometimes abuse notation and write $V = \bigoplus_i V_i$.

- The *direct product* $\prod_{\alpha} V(\alpha)$ is the family $\{\prod_{\alpha} V(\alpha)_i\}$. The direct product of V and W is written $V \times W$.

- A graded module, V , is *free* if each V_i is a free module. In this case the disjoint union of bases of the V_i is called a *basis for V* .
- A *linear map* $f : V \rightarrow W$ of degree i (between graded modules) is a family of linear maps $f_j : V_j \rightarrow W_{j+i}$. It determines graded submodules $\ker f \subset V$ and $\text{Im } f \subset W$: $(\ker f)_j = \ker f_j$ and $(\text{Im } f)_j = \text{Im } f_{j-i}$. We denote by $\text{Hom}(V, W)$ the graded module whose elements of degree i are the linear maps of degree i . If $f : V' \rightarrow V$ and $g : W \rightarrow W'$ are linear maps then $\text{Hom}(f, g) : \text{Hom}(V, W) \rightarrow \text{Hom}(V', W')$ is the linear map $\varphi \mapsto (-1)^{\deg f(\deg g + \deg \varphi)} g\varphi f$.
- The module $\text{Hom}(V, \mathbb{k})$ dual to V will be denoted by V^\sharp , and $f^\sharp = \text{Hom}(f, \mathbb{k}) : W^\sharp \rightarrow V^\sharp$ will denote the *dual* of the linear map f .
- Suppose $f_\alpha : V(\alpha) \rightarrow Z$ are linear maps of degree zero. The *fibre product*, $(\prod_{\alpha \in \mathcal{I}})_{Z(V(\alpha))}$, is the submodule of $\prod_{\alpha \in \mathcal{I}} V(\alpha)$ consisting of the elements $\{v_\alpha\}$ satisfying $f_\alpha(v_\alpha) = f_\beta(v_\beta)$, $\alpha, \beta \in \mathcal{I}$. The fibre product of V and W is written $V \times_Z W$.
- The *tensor product* $V \otimes W$ of graded modules is defined by $(V \otimes W)_i = \bigoplus_{j+k=i} V_j \otimes W_k$. If $f : V \rightarrow V'$ and $g : W \rightarrow W'$ are linear maps of degrees p and q , then $f \otimes g : V \otimes W \rightarrow V' \otimes W'$ is the linear map:

$$(f \otimes g)(v \otimes w) = (-1)^{\deg g \deg v} f(v) \otimes g(w)$$

of degree $p + q$. If $f : V \rightarrow V'$ we frequently (but not always) simplify $f \otimes id_W$ to $f \otimes W : V \otimes W \rightarrow V' \otimes W$.

- A *p -linear map* is a map $\alpha : V(1) \times \dots \times V(p) \rightarrow W$ of the form $\alpha(v_1, \dots, v_p) = \beta(v_1 \otimes \dots \otimes v_p)$, where $\beta : V_1 \otimes \dots \otimes V_p \rightarrow W$ is a linear map. A bilinear map $V \times W \rightarrow \mathbb{k}$ is called a *pairing* and is often written $v, w \mapsto \langle v, w \rangle$. It determines (and is determined by) the linear map $\varphi : V \rightarrow W^\sharp$ given by $(\varphi v)w = \langle v, w \rangle$. In particular, if \mathbb{k} is a field and V^\sharp and W^\sharp are the dual graded vector spaces, then $V^\sharp \otimes W^\sharp$ is the subspace of $(V \otimes W)^\sharp$ given by

$$\langle v' \otimes w', v \otimes w \rangle = (-1)^{\deg w' \deg v} \langle v', v \rangle \langle w', w \rangle.$$

In addition,

- The *suspension* of a graded module V is the graded module sV defined by $(sV)_i = V_{i-1}$. If $v \in V_{i-1}$ the corresponding element in $(sV)_i$ is denoted by sv .
- We shall use the *classical convention*

$$V^i = V_{-i}$$

to avoid negative degrees. Thus *the degree of an element will depend on the context*, depending on whether we are using upper or lower degrees. For example, if $f : V \rightarrow W$ has degree -1 with respect to lower degrees, ($f : V_i \rightarrow W_{i-1}$), then it has degree $+1$ ($f : V^i \rightarrow W^{i+1}$) with respect to upper degrees. In this section 'degree' will always mean 'lower degree' unless otherwise specified.

- We use the notation $V_{>k} = \{V_i\}_{i>k}$ and $V_{\geq k} = \{V_i\}_{i\geq k}$. The graded submodules $V_{<k}, V_{\leq k}, V^{>k}, V^{\geq k}, V^{<k}, V^{\leq k}$ are defined analogously. Moreover we write

$$V^+ = \{V^i\}_{i>0} \quad \text{and} \quad V_+ = \{V_i\}_{i>0} .$$

A sequence $M \xrightarrow{f} N \xrightarrow{g} Q$ of linear maps is *exact* if $\ker g = \text{Im } f$. If also f is injective and g is surjective then $0 \rightarrow M \xrightarrow{f} N \xrightarrow{g} Q \rightarrow 0$ is a *short exact sequence*. A routine check establishes

Lemma 3.1 (Five lemma) *Suppose given a commutative row-exact diagram of linear maps of graded modules*

$$\begin{array}{ccccccccc} L & \longrightarrow & M & \longrightarrow & N & \longrightarrow & P & \longrightarrow & Q \\ \downarrow \alpha_L & & \downarrow \alpha_M & & \downarrow \alpha_N & & \downarrow \alpha_P & & \downarrow \alpha_Q \\ L' & \longrightarrow & M' & \longrightarrow & N' & \longrightarrow & P' & \longrightarrow & Q' . \end{array}$$

- (i) *If α_L is surjective and α_M and α_P are injective then α_N is injective.*
- (ii) *If α_M and α_P are surjective and α_Q is injective then α_N is surjective.*
- (iii) *If α_L is surjective, α_Q is injective and α_M and α_P are isomorphisms then α_N is an isomorphism. \square*

A *differential* in a graded module $M = \{M_i\}_{i \in \mathbb{Z}}$ is a linear map $d : M \rightarrow M$ of degree -1 such that $d^2 = 0$, and the pair (M, d) is called a *complex*. The elements of $\ker d$ are *cycles*, the elements of $\text{Im } d$ are *boundaries* and the quotient graded module $H(M, d) = \ker d / \text{Im } d$ is the *homology* of M . We often simplify the notation to $H(M)$.

A *morphism of complexes* $\varphi : (M, d) \rightarrow (N, d)$ is a linear map $\varphi : M \rightarrow N$ of degree zero satisfying $\varphi d = d\varphi$. It induces $H(\varphi) : H(M) \rightarrow H(N)$. If $H(\varphi)$ is an isomorphism, φ is called a *quasi-isomorphism* and we write $\varphi : M \xrightarrow{\sim} N$. Two morphisms φ and ψ are *homotopic* if there is a linear map $h : M \rightarrow N$ of degree 1 such that $\varphi - \psi = hd + dh$. We write $\varphi \sim \psi : (M, d) \rightarrow (N, d)$ and call h a *chain homotopy*.

A *chain equivalence* $\varphi : (M, d) \rightarrow (N, d)$ is a morphism such that there is a second morphism $\psi : (N, d) \rightarrow (M, d)$ satisfying $\varphi\psi \sim id_N$ and $\psi\varphi \sim id_M$. Since $H(\varphi)$ and $H(\psi)$ are then inverse isomorphisms, a chain equivalence is a quasi-isomorphism.

If (M, d) and (N, d) are complexes, then so are $\text{Hom}(M, N)$ and $M \otimes N$:

$$d(f) = df - (-1)^{\deg f} fd, \quad f \in \text{Hom}(M, N), \quad \text{and}$$

$$d(m \otimes n) = dm \otimes n + (-1)^{\deg m} m \otimes dn, \quad m \in M, \quad n \in N.$$

Note that in particular the differential in $\text{Hom}(M, \mathbb{k})$ is the negative of the dual of the differential in M .

Suppose f is a cycle in $\text{Hom}(M, N)$; i.e. $df = (-1)^{\deg f} fd$. Consistent with the notation above we define a linear map $H(f) : H(M) \rightarrow H(N)$ by $H(f)[z] = [f(z)]$, where $[]$ denotes 'homology class'.

Lemma 3.2 *A necessary and sufficient condition for $H(f)$ to be an isomorphism (of degree i) is that for each $(m, n) \in M \times N$ satisfying $dm = 0$ and $f(m) = dn$ there exist $(m', n') \in M \times N$ satisfying $dm' = m$ and $dn' = n - f(m')$.*

proof: Suppose the condition holds. If $dm = 0$ and $H(f)[m] = 0$ then $f(m) = dn$; hence $m = dm'$ and $[m] = 0$. If $[n] \in H(N)$ then $dn = 0 = f(0)$ and so there exist (m', n') with $dm' = m$ and $dn' = n - f(m')$; i.e. $[n] = H(f)[m']$.

Suppose $H(f)$ is an isomorphism. Given (m, n) as in the lemma we have $H(f)[m] = 0$. Hence $m = dm''$. Now $n - f(m'')$ is cycle; hence $[n - f(m'')] = H(f)[z] = [f(z)]$. Thus $m = d(m'' + z)$ and $n - f(m'' + z) = dn'$. Set $m' = m'' + z$. □

A *chain complex* is a complex (M, d) with $M = \{M_n\}_{n \geq 0}$; a *cochain complex* is a complex (M, d) with $M = \{M^n\}_{n \geq 0}$. In the latter case d has (upper) degree 1, the elements of $\ker d$ are *cocycles*, the elements of $\text{Im } d$ are *coboundaries* and $H(M, d)$ is the *cohomology*.

The *suspension* of a complex (M, d) is the complex $s(M, d) = (sM, d)$ defined by $sdx = -dsx$.

A short exact sequence of morphisms of complexes, $0 \rightarrow (M, d) \xrightarrow{\alpha} (N, d) \xrightarrow{\beta} (Q, d) \rightarrow 0$ induces a *long exact homology sequence*,

$$\dots \rightarrow H_i(M) \xrightarrow{H_i(\alpha)} H_i(N) \xrightarrow{H_i(\beta)} H_i(Q) \xrightarrow{\partial} H_{i-1}(M) \rightarrow \dots,$$

defined for all i , in which the *connecting homomorphism* ∂ is defined in the usual way: if $z \in Q$ represents $[z] \in H_i(Q)$ and if $\beta n = z$ then $\partial[z]$ is represented by the unique cycle $x \in M$ such that $\alpha x = dn$.

(b) Graded algebras.

A *graded algebra* is a graded module R together with an associative linear map of degree zero, $R \otimes R \rightarrow R$, $x \otimes y \mapsto xy$, that has an identity $1 \in R_0$. Thus for all $x, y, z \in R$ $(xy)z = x(yz)$ and $1x = x = x1$. We regard \mathbb{k} as a graded algebra concentrated in degree 0. A *morphism* $\varphi : R \rightarrow S$ of graded algebras is a linear map of degree zero such that $\varphi(xy) = \varphi(x)\varphi(y)$ and $\varphi(1) = 1$.

An *augmentation* for a graded algebra R is a morphism $\varepsilon : R \rightarrow \mathbb{k}$ of graded algebras.

A *derivation of degree k* is a linear map $\theta : R \rightarrow R$ of a degree k such that $\theta(xy) = (\theta x)y + (-1)^{k \deg x} x(\theta y)$.

Let R be a graded algebra. A (*left*) R -*module* is a graded module M together with a linear map of degree zero $R \otimes M \rightarrow M$, $x \otimes m \mapsto xm$, such that $x(y m) = (xy)m$ and $1m = m$ for all $x, y \in R$ and $m \in M$. Right modules are defined analogously.

An R -*linear map* $f : M \rightarrow N$ of degree k is a linear map of degree k such that

$$f(xm) = (-1)^{\deg f \deg x} x f(m), \quad x \in R, m \in M.$$

These form a graded submodule $\text{Hom}_R(M, N)$ of the graded module $\text{Hom}(M, N)$.

The *tensor product* $M' \otimes_R M$ of a right R -module M' and a left R -module M is the quotient module

$$M' \otimes_R M = (M' \otimes M) / (m'x \otimes n - m' \otimes xn),$$

where we have divided by the submodule spanned by elements of the form $m'x \otimes n - m' \otimes xn$, $m' \in M'$, $m \in M$, $x \in R$. We use $m' \otimes m$ to denote the obvious element in $M' \otimes M$; its image in $M' \otimes_R M$, is denoted by $m' \otimes_R m$.

Let R be a graded algebra. A *left ideal* I in R is a graded submodule such that $xy \in I$ for $x \in R$ and $y \in I$. *Right ideals*, (*two sided*) *ideals* and *subalgebras* are defined analogously. Note that subalgebras must contain 1. The quotient R/I of R by an ideal I is a graded algebra.

Example 1 *Change of algebra.*

A morphism $\varphi : R \rightarrow S$ of graded algebras makes S into a left (and right) R -module

$$x \cdot s = \varphi(x)s \quad \text{or} \quad s \cdot x = s\varphi(x), \quad x \in R, s \in S.$$

If M is an R -module then $S \otimes_R M$ is an S -module via $s \cdot (s' \otimes_R m) = ss' \otimes_R m$. \square

Example 2 *Free modules.*

Let R be a graded algebra. An R -module M is *free* if $M \cong R \otimes V$, with V a free graded module. A basis $\{v_\alpha\}$ for V is a basis for the free R -module M . If $\varphi : R \rightarrow S$ is a morphism of graded algebras then

$$S \otimes_R M = S \otimes_R (R \otimes V) = S \otimes V$$

is a free S -module with the same basis.

If M is a free R -module with basis $\{v_\alpha\}$ and if N is any R -module, then the choice of elements $n_\alpha \in N_{k+|v_\alpha|}$ determines a unique R -linear map $f : M \rightarrow N$ of degree k with $f(v_\alpha) = n_\alpha$. \square

Example 3 *Tensor product of graded algebras.*

If R, S are graded algebras then $R \otimes S$ denotes the graded algebra with multiplication

$$(x \otimes y)(x' \otimes y') = (-1)^{\deg y \deg x'} xx' \otimes yy'.$$

□

Example 4 *Tensor algebra.*

For any free graded module V , the tensor algebra TV is defined by

$$TV = \bigoplus_{q=0}^{\infty} T^q V \quad T^q V = \underbrace{V \otimes \cdots \otimes V}_q.$$

Multiplication is given by $a \cdot b = a \otimes b$. Note that q is *not* the degree: elements $v_1 \otimes \cdots \otimes v_q \in T^q V$ have degree $= \sum \deg v_i$ and *word length* q . If $\{v_i\}$ is a basis of V we may write $TV = T(\{v_i\})$.

Any linear map of degree zero from V to a graded algebra R extends to a unique morphism of graded algebras, $TV \rightarrow R$. Any degree k linear map $V \rightarrow TV$ extends to a unique derivation of TV . □

Example 5 *Commutative graded algebras.*

A graded algebra A is *commutative* if

$$xy = (-1)^{\deg x \deg y} yx, \quad x, y \in A.$$

When $\frac{1}{2} \in \mathbb{k}$ this condition implies that $x^2 = 0$ if x has odd degree. If A is a commutative graded algebra, then a left A -module, M , is automatically a right A -module, via

$$mx = (-1)^{\deg m \deg x} xm.$$

If N is a second A -module then $\text{Hom}_A(M, N)$ and $M \otimes_A N$ are A -modules via

$$(xf)(m) = x \cdot f(m) = (-1)^{\deg x \deg f} f(xm)$$

and

$$x(m \otimes_A n) = xm \otimes_A n = (-1)^{\deg x \deg m} m \otimes_A xn, \quad x \in A, m \in M, n \in N.$$

If $A \rightarrow B, A \rightarrow C$ are morphisms of commutative graded algebras then $B \otimes C$ is also commutative and the kernel of the surjection $B \otimes C \rightarrow B \otimes_A C$ is an ideal. Thus $B \otimes_A C$ is also a commutative graded algebra. □

Example 6 *Free commutative graded algebras.*

Suppose \mathbb{k} contains $\frac{1}{2}$. Let V be a free graded module. The elements $v \otimes w - (-1)^{\deg v \deg w} w \otimes v$ ($v, w \in V$) generate an ideal $I \subset TV$. The quotient graded algebra

$$\Lambda V = TV/I$$

is called the *free commutative graded algebra* on V . If $\{v_i\}$ is a basis of V we may write $\Lambda V = \Lambda(\{v_i\})$. The algebra ΛV has the following properties:

- (i) ΛV is graded commutative; in particular, the square of an element of odd degree in ΛV is zero.
- (ii) There is a unique isomorphism $\Lambda(V \oplus W) = \Lambda V \otimes \Lambda W$ which is the identity in V and in W .
- (iii) If V is free on a single basis element $\{v\}$ then a basis of ΛV is given by:

$$\begin{cases} 1 & v & & & & & \text{if } \deg v \text{ is odd} \\ 1 & v & v^2 & v^3 & \dots & & \text{if } \deg v \text{ is even.} \end{cases}$$

- (iv) A linear map of degree zero from V to a commutative graded algebra A extends to a unique morphism of graded algebras, $\Lambda V \rightarrow A$. A linear map $V \rightarrow \Lambda V$ of degree k extends to a unique derivation in ΛV .
- (v) Suppose $\varphi : \Lambda V \rightarrow A$ is a morphism of graded algebras and θ and θ' are derivations respectively in ΛV and in A . If $\varphi\theta v = \theta'\varphi v$, $v \in V$, then $\varphi\theta = \theta'\varphi$.
- (vi) $\Lambda V = \bigoplus_{q=0}^{\infty} \Lambda^q V$, where $\Lambda^q V$ is the linear span of the elements $v_1 \wedge \dots \wedge v_q$, $v_i \in V$; these elements have degree $= \sum_i \deg v_i$ and *word length* q .

□

(c) Differential graded algebras.

A *differential graded algebra* (dga for short) is a graded algebra R together with a differential in R that is a derivation. In this situation $\ker d$ is a subalgebra and $\text{Im } d$ is an ideal in $\ker d$. The *homology algebra* $H(R, d)$ of a differential graded algebra (R, d) is the graded algebra $H(R, d) = \ker d / \text{Im } d$. An *augmentation* is a morphism $\varepsilon : (R, d) \rightarrow \mathbb{k}$.

A *morphism* of differential graded algebras $f : (R, d) \rightarrow (S, d)$ is a morphism of graded algebras satisfying $fd = df$. It induces a morphism $H(f) : H(R) \rightarrow H(S)$ of graded algebras.

If (R, d) and (S, d) are dga's then so is $(R, d) \otimes (S, d)$ with the differential described in (a) and the multiplication given in Example 3 of (b). This is called the *tensor product dga*.

A *chain algebra* is a dga (R, d) with $R = \{R_n\}_{n \geq 0}$. A *cochain algebra* is a dga (R, d) with $R = \{R^n\}_{n \geq 0}$. In the latter case $H(R, d)$ is the *cohomology algebra* of (R, d) .

A (*left*) *module* over a differential graded algebra (R, d) is an R -module, M , together with a differential d in M satisfying

$$d(x \cdot m) = dx \cdot m + (-1)^{\deg x} x \cdot dm, \quad x \in R, m \in M.$$

Then $H(M)$ is an $H(R)$ -module via

$$[x] \cdot [m] = [x \cdot m].$$

A *morphism* of (left) modules over a dga (R, d) , is a morphism $f : (M, d) \rightarrow (N, d)$ of graded R -modules satisfying $df = fd$. The induced map $H(f) : H(M) \rightarrow H(N)$ is then a morphism of $H(R)$ -modules.

If (M, d) and (N, d) are left (R, d) -modules, then $\text{Hom}_R(M, N)$ is a subcomplex of $\text{Hom}(M, N)$. In the same way, if (M', d) is a right (R, d) -module then the differential d defined on $M' \otimes M$ induces a differential in $M' \otimes_R M$ so that $M' \otimes_R M$ is naturally a complex.

Example 1 $\text{Hom}_R(M, M)$.

If (M, d) is any (R, d) -module, then $\text{Hom}_R(M, M)$ is a differential graded algebra with multiplication defined by the composition of maps. \square

Example 2 *Tensor products.*

If $(A, d) \rightarrow (B, d)$ and $(A, d) \rightarrow (C, d)$ are morphisms of commutative dga's then $(B \otimes_A C, d)$ is a commutative dga. \square

Example 3 *Direct products.*

If (A, d) and (A', d) are dga's then the *direct product* $(A, d) \times (A', d)$ is the dga $(A \times A', d)$ given by $(a, a') \cdot (a_1, a'_1) = (aa_1, a'a'_1)$ and $d(a, a') = (da, da')$. The direct product, $\prod_{\alpha} (A(\alpha), d)$, of a family of dga's is defined in the same way. \square

Example 4 *Fibre products.*

If $f : (A, d) \rightarrow (B, d)$ and $f' : (A', d) \rightarrow (B, d)$ are dga morphisms then $(A \times_B A', d)$ is a sub dga of $(A, d) \times (A', d)$. It is called the *fibre product* of (A, d) and (A', d) . The fibre product of a family of dga's $(A(\alpha), d)$ with respect to dga morphisms $f_{\alpha} : (A(\alpha), d) \rightarrow (B, d)$ is the sub dga $((\prod_{\alpha})_B A(\alpha), d)$ of $\prod_{\alpha} (A(\alpha), d)$. \square

(d) Graded coalgebras.

A *graded coalgebra* C is a graded module C together with two linear maps of degree zero: a *comultiplication* $\Delta : C \rightarrow C \otimes C$ and an *augmentation* $\varepsilon : C \rightarrow \mathbb{k}$ such that $(\Delta \otimes id)\Delta = (id \otimes \Delta)\Delta$ and $(id \otimes \varepsilon)\Delta = (\varepsilon \otimes id)\Delta = id_C$. A *morphism* $\varphi : C \rightarrow C'$ of graded coalgebras is a linear map of degree zero such that $(\varphi \otimes \varphi)\Delta = \Delta'\varphi$ and $\varepsilon = \varepsilon'\varphi$. A *graded (left) comodule* over a graded coalgebra C is a graded vector space M together with a linear map $\Delta_M : C \rightarrow C \otimes M$ of degree zero such that $(\Delta \otimes id)\Delta_M = (id \otimes \Delta_M)\Delta_M$ and $(\varepsilon \otimes id_M)C = id_M$.

A graded coalgebra is *co-commutative* if

$$\tau\Delta = \Delta$$

where $\tau : C \otimes C \rightarrow C \otimes C$ is the involution $a \otimes b \mapsto (-1)^{\deg a \deg b} b \otimes a$.

A graded coalgebra is *coaugmented* by the choice of an element $1 \in C_0$ such that $\varepsilon(1) = 1$ and $\Delta(1) = 1 \otimes 1$. Given such a choice the relations above imply that for $a \in \ker \varepsilon$,

$$\Delta a - (a \otimes 1 + 1 \otimes a) \in \ker \varepsilon \otimes \ker \varepsilon .$$

An element, a , in a coaugmented graded coalgebra is called *primitive* if $a \in \ker \varepsilon$ and $\Delta a = a \otimes 1 + 1 \otimes a$. Primitive elements form a graded submodule of $\ker \varepsilon$, and a morphism of coaugmented graded coalgebras sends primitive elements to primitive elements.

A *coderivation* of degree k in a graded coalgebra C is a linear map $\theta : C \rightarrow C$ of degree k such that $\Delta \theta = (\theta \otimes id + id \otimes \theta) \Delta$ and $\varepsilon \theta = 0$.

A *differential graded coalgebra* (*dgc* for short) is a graded coalgebra C together with a differential that is a coderivation in C .

If C is a graded coalgebra, then $\text{Hom}(C, \mathbb{k})$ is a graded algebra whose multiplication is defined by

$$(f \cdot g)(c) = (f \otimes g)(\Delta c), \quad f, g \in \text{Hom}(C, \mathbb{k}), \quad c \in C$$

and with identity the map $\varepsilon : C \rightarrow \mathbb{k}$. If (C, d) is a differential graded coalgebra, then $C^\sharp = \text{Hom}(C, \mathbb{k})$ is a differential graded algebra.

Remark Henceforth we may occasionally suppress the differential from the notation, writing M, R, \dots for a differential graded module (M, d) , a dga $(R, d), \dots$

(e) When \mathbb{k} is a field.

Recall that complexes (M, d) and (N, d) determine the complexes $M \otimes N$ and $\text{Hom}(M, N)$ with $d(m \otimes n) = dm \otimes n + (-1)^{\deg m} m \otimes dn$ and $df = d \circ f - (-1)^{\deg f} f \circ d$. Natural linear maps

$$H(M) \otimes H(N) \rightarrow H(M \otimes N) \quad \text{and} \quad H(\text{Hom}(M, N)) \rightarrow \text{Hom}(H(M), H(N))$$

are given by $[z] \otimes [w] \mapsto [z \otimes w]$ and $[f] \mapsto H(f)$. (Recall that $H(f)[z] = [f(z)]$).

Proposition 3.3. *If \mathbb{k} is a field these natural maps are isomorphisms:*

$$H(M) \otimes H(N) = H(M \otimes N) \quad \text{and} \quad H(\text{Hom}(M, N)) = \text{Hom}(H(M), H(N)) .$$

proof: This is a straightforward exercise using the fact that any complex M can be written $M = \text{Im } d \oplus H \oplus C$ with $d : C \xrightarrow{\cong} \text{Im } d$ and $d = 0$ in H . \square

In particular, suppose (C, d) is a dgc over a field \mathbb{k} . Using the first isomorphism of Proposition 3.3 we may write $H(\Delta) : H(C) \rightarrow H(C) \otimes H(C)$. Together with $H(\varepsilon)$ this makes $H(C)$ into a graded coalgebra. The dual algebra,

$\text{Hom}(H(C), \mathbb{k})$ is just the homology algebra of the dga, $\text{Hom}(C, \mathbb{k})$, as follows again from Proposition 3.3.

If \mathbb{k} is a field we say a graded vector space $M = \{M_i\}$ has *finite type* if each M_i is finite dimensional. If also M is concentrated in finitely many degrees then M is *finite dimensional* and $\dim M = \sum_i \dim M_i$.

When M has finite type its *Hilbert series* is the formal series

$$M_*(z) = \sum_{i=-\infty}^{\infty} (\dim M_i) z^i .$$

However if $M = \{M^i\}$ we write $M^*(z) = \sum_i (\dim M^i) z^i$. When the context is clear we simply write $M(z)$.

If M is finite dimensional then its *Euler-Poincaré characteristic* is the integer χ_M defined by

$$\chi_M = \sum (-1)^i \dim M_i = \dim M_{\text{even}} - \dim M_{\text{odd}} = M_*(-1) .$$

If M is equipped with a differential then it is an easy exercise to verify that

$$\chi_M = \chi_{H(M)} . \tag{3.4}$$

A graded algebra R (or a dga) has *finite type* if each R_i is finite dimensional; i.e. if it has finite type as a graded vector space. Similarly a *graded R -module of finite type* is an R -module M such that each M_i is finite dimensional. By contrast R is *finitely generated* if it is generated by a finite set of elements (i.e. if there is a surjection $T(v_1, \dots, v_k) \rightarrow R$). Similarly M is a *finitely generated R module* if every $m \in M$ can be expressed as $m = \sum_{i=1}^{\ell} x_i m_i$, $x_i \in R$, where m_1, \dots, m_{ℓ} is a fixed set of elements of M .

Exercises

1. A complex M is *acyclic* if $H_i(M) = 0$, $i = 0, 1, \dots$. Prove that if M is an acyclic R -free chain complex then $id_M \sim 0$. Let M and N be graded chain complexes. Under what conditions is the complex $\text{Hom}(M, N)$ acyclic?
2. Let (M, d_M) and (N, d_N) be chain complexes and $f \in \text{Hom}^0(M, N)$. Prove that if M is an R -free module then f is a chain equivalence if and only if the chain complex (C, d) defined by $C_k = M_{k-1} \oplus N_k$, $d(m, n) = (-d_M m, f(m) + d_N n)$ is acyclic.
3. Consider the free commutative differential graded algebra $(\wedge(x, y, z), d)$ with $\deg x = \deg y = \deg z = 1$ and $dx = yz, dy = zx, dz = xy$. Prove that the map $\varphi: (\wedge t, 0) \rightarrow (\wedge(x, y, z), d)$ defined by $\varphi(t) = xyz$ is a quasi-isomorphism.

4. Let TV be the tensor algebra on the graded vector space V .

Define $\Delta : TV \rightarrow TV \otimes TV$, $\varepsilon : TV \rightarrow \mathbb{k}$, by

$$\begin{aligned} \Delta(v_1 \otimes v_2 \otimes \dots \otimes v_n) &= \sum_{i=0}^n (v_1 \otimes v_2 \otimes \dots \otimes v_i) \otimes (v_{i+1} \otimes v_{i+2} \otimes \dots \otimes v_n) \\ \varepsilon(1) &= 1 \text{ and } \varepsilon(v_1 \otimes v_2 \otimes \dots \otimes v_n) = 0 \text{ if } n \geq 1. \end{aligned}$$

Prove that $(T(V), \Delta, \varepsilon)$ is a non cocommutative graded coalgebra.

5. Let (M, d_M) and (N, d_N) be chain complexes. Prove that if M is an R -free chain complex then the complex $\text{Hom}(M, N)$ is isomorphic to the complex $\text{Hom}(M, R) \otimes N$.

6. Let (M, d_M) be a chain complex. Prove that if M is of finite type then there exists a Hilbert series $Q(z)$ such that $M(z) = H(M)(z) + (1+z)Q(z)$.

4 Singular chains, homology and Eilenberg-MacLane spaces

As usual, we work over an arbitrary commutative ground ring \mathbb{k} .

This section is a quick review of singular homology. Distinct from the usual approach, however, is our use of normalized singular chains, so as to arrange that the chains on a point vanish in positive degrees. We also take great care with the comparison between $C_*(X \times Y)$ and $C_*(X) \otimes C_*(Y)$, using the classical Alexander-Whitney and Eilenberg-Zilber equivalences because these have important associativity and compatibility properties on which we will subsequently need to rely.

Beyond the standard material of elementary singular homology we:

- *show that a weak homotopy equivalence induces an isomorphism in homology.*
- *construct the cellular chain complex of a CW complex and show that it is chain equivalent to the singular chain complex.*
- *prove the Hurewicz theorem identifying the first non-vanishing homotopy and homology groups of a space (except when $\pi_1 \neq 0$, in which case $\pi_1/[\pi_1, \pi_1] \cong H_1$).*

Finally, we construct the Eilenberg-MacLane spaces $K(\pi, n)$ for a group π (abelian if $n \geq 2$) and show that if X is an $(n-1)$ -connected CW complex then $[X, K(\pi, n)] \cong \text{Hom}(\pi_n(X), \pi)$, the isomorphism being given by $[f] \mapsto \pi_n(f)$. In fact this theorem generalizes to the famous

Theorem ([E]) *For any CW complex X a bijection $[X, K(\pi, n)] \xrightarrow{\cong} H^n(X; \pi)$ is given by $[f] \mapsto H^n(f)\iota$, ι denoting the fundamental class of $H^n(K(\pi, n); \pi)$.*

However we shall not need this result, and so it is not included in the text.

This section is organized into the following topics:

- (a) Basic definitions, (normalized) singular chains.
- (b) Topological products, tensor products and the dgc, $C_*(X; \mathbb{k})$.
- (c) Pairs, excision, homotopy and the Hurewicz homomorphism.
- (d) Weak homotopy equivalences.
- (e) Cellular homology and the Hurewicz theorem.
- (f) Eilenberg-MacLane spaces

(a) Basic definitions, (normalized) singular chains.

Recall that a *singular n -simplex* in a space X is a continuous map

$$\sigma : \Delta^n \longrightarrow X ,$$

where $n \geq 0$ and $\Delta^n = \left\{ \sum_0^n t_i e_i \mid 0 \leq t_i \leq 1, \sum t_i = 1 \right\}$ is the convex hull of the standard basis e_0, \dots, e_n of \mathbb{R}^{n+1} . If $X \subset \mathbb{R}^m$ is a convex subset then any sequence $x_0, \dots, x_n \in X$ determines the *linear simplex*

$$\langle x_0 \dots x_n \rangle : \Delta^n \longrightarrow X, \quad \sum t_i e_i \longmapsto \sum t_i x_i.$$

Two important examples of linear simplices are the *i -th face inclusion* of Δ^n ,

$$\lambda_i = \langle e_0 \dots \hat{e}_i \dots e_n \rangle : \Delta^{n-1} \longrightarrow \Delta^n, \quad (\hat{} \text{ means omit})$$

defined for $n \geq 1$ and $0 \leq i \leq n$; and the *j -th degeneracy* of Δ^n ,

$$\varrho_j = \langle e_0 \dots e_j e_j \dots e_n \rangle : \Delta^{n+1} \longrightarrow \Delta^n,$$

defined for $n \geq 0$ and $0 \leq j \leq n$. The image of λ_i is called the *i -th face* of Δ^n .

Denote by $S_n(X)$ the set of singular n -simplices on a space X ($n \geq 0$), and by

$$S_n(\varphi) : S_n(X) \longrightarrow S_n(Y), \quad S_n(\varphi) : \sigma \longmapsto \varphi \circ \sigma ,$$

the set map induced from a continuous map $\varphi : X \rightarrow Y$. The set maps

$$\partial_i : S_{n+1}(X) \rightarrow S_n(X), \quad \sigma \mapsto \sigma \circ \lambda_i \quad \text{and} \quad s_j : S_n(X) \rightarrow S_{n+1}(X), \quad \sigma \mapsto \sigma \circ \varrho_j$$

are called the *face and degeneracy maps*; they commute with the set maps $S_*(\varphi)$.

A straightforward calculation shows that

$$\begin{aligned} \partial_i \partial_j &= \partial_{j-1} \partial_i & , \quad i < j; \\ s_i s_j &= s_{j+1} s_i & , \quad i \leq j; \\ \partial_i s_j &= \begin{cases} s_{j-1} \partial_i & , \quad i < j \\ id & , \quad i = j, j+1 \\ s_j \partial_{i-1} & , \quad i > j+1. \end{cases} & (4.1) \end{aligned}$$

The free \mathbb{k} -module with basis $S_n(X)$ will be denoted $CS_n(X; \mathbb{k})$, and the *singular chain complex* of X is the chain complex $CS_*(X; \mathbb{k}) = \{CS_n(X; \mathbb{k})\}_{n \geq 0}$, with differential $d = \sum_i (-1)^i \partial_i$. Its homology, denoted $H_*(X; \mathbb{k})$, is the *singular homology* of X .

An $n+1$ simplex of the form $s_i \tau$ ($\tau \in S_n(X)$, $0 \leq i \leq n$) is called *degenerate* and the degenerate simplices span a submodule $DS_{n+1}(X)$ of $CS_{n+1}(X; \mathbb{k})$. It follows easily (cf. [118]) from (4.1) that $DS_*(X)$ is a subchain complex of $CS_*(X; \mathbb{k})$ and that $H(DS_*(X)) = 0$. We will use the quotient chain complex:

$$C_*(X; \mathbb{k}) = CS_*(X; \mathbb{k}) / DS_*(X)$$

it is called the *normalized singular chain complex* of X .

The following properties follow immediately from the definitions and the remarks above:

- $C_n(X; \mathbb{k})$ is a free module with the non-degenerate n -simplices as basis.
- The surjection $CS_*(X; \mathbb{k}) \rightarrow C_*(X; \mathbb{k})$ is a quasi-isomorphism. Thus we may (and do) use this to identify

$$H_*(X; \mathbb{k}) = H(C_*(X; \mathbb{k})). \quad (4.2)$$

- $C_*(pt) = \mathbb{k}$, concentrated in degree zero.

(The last property follows because $\Delta^n \rightarrow pt$ is degenerate for $n \geq 1$.)

A continuous map $f : X \rightarrow Y$ induces the morphism $C_*(f) : C_*(X; \mathbb{k}) \rightarrow C_*(Y; \mathbb{k})$ defined by $C_*(f)\sigma = f \circ \sigma$; we write $H_*(f)$ for $H(C_*(f))$. In particular, for the constant map $X \rightarrow pt$ we may identify

$$C_*(const) = \varepsilon : C_*(X; \mathbb{k}) \rightarrow \mathbb{k}.$$

This is called *the augmentation* of $C_*(X; \mathbb{k})$.

Remark $CS_*(-)$ vs $C_*(-)$.

Most presentations of singular homology use $CS_*(-)$ since it is simpler to describe, and gives the same answer. For us, however, the property $C_*(\{pt\}; \mathbb{k}) = \mathbb{k}$ turns out to be really useful.

The constructions that follow are all made first at the level of $S_*(X)$, then by linear extension to $CS_*(X; \mathbb{k})$ and then (by factoring) in $C_*(X; \mathbb{k})$. We shall describe *only the first step*, leaving the rest to the reader.

(b) Topological products, tensor products and the dgc, $C_*(X; \mathbb{k})$.

We recall now how topological products are modelled by tensor products of chain complexes. As in §3, $- \otimes -$ denotes $- \otimes_{\mathbb{k}} -$. First note that $CS_*(X; \mathbb{k}) \otimes CS_*(Y; \mathbb{k})$ is a free graded module with basis the tensor products $\sigma \otimes \tau$ of singular simplices in X and Y . Moreover $C_*(X; \mathbb{k}) \otimes C_*(Y; \mathbb{k})$ is the quotient chain complex obtained by dividing by those $\sigma \otimes \tau$ with at least one of σ, τ degenerate. Thus, as remarked above, constructions in $CS_*(-)$ pass to $C_*(-)$ by factoring.

There are two important chain complex maps that model topological products by tensor products. The first is the Alexander-Whitney map

$$AW : C_*(X \times Y; \mathbb{k}) \rightarrow C_*(X; \mathbb{k}) \otimes C_*(Y; \mathbb{k}).$$

defined as follows: If $(\sigma, \tau) : \Delta^n \rightarrow X \times Y$ is any singular simplex on $X \times Y$ then

$$AW(\sigma, \tau) = \sum_{k=0}^n \sigma \circ \langle e_0, \dots, e_k \rangle \otimes \tau \circ \langle e_k, \dots, e_n \rangle.$$

The second is the *Eilenberg-Zilber map*

$$EZ : C_*(X; \mathbb{k}) \otimes C_*(Y; \mathbb{k}) \rightarrow C_*(X \times Y; \mathbb{k}),$$

whose construction is based on a combinatorial description of the product $\Delta^p \times \Delta^q$ of two standard simplices with vertices v_0, \dots, v_p and w_0, \dots, w_q . When $p = q = 1$ this reduces to the decomposition of $I \times I$ into two triangles:

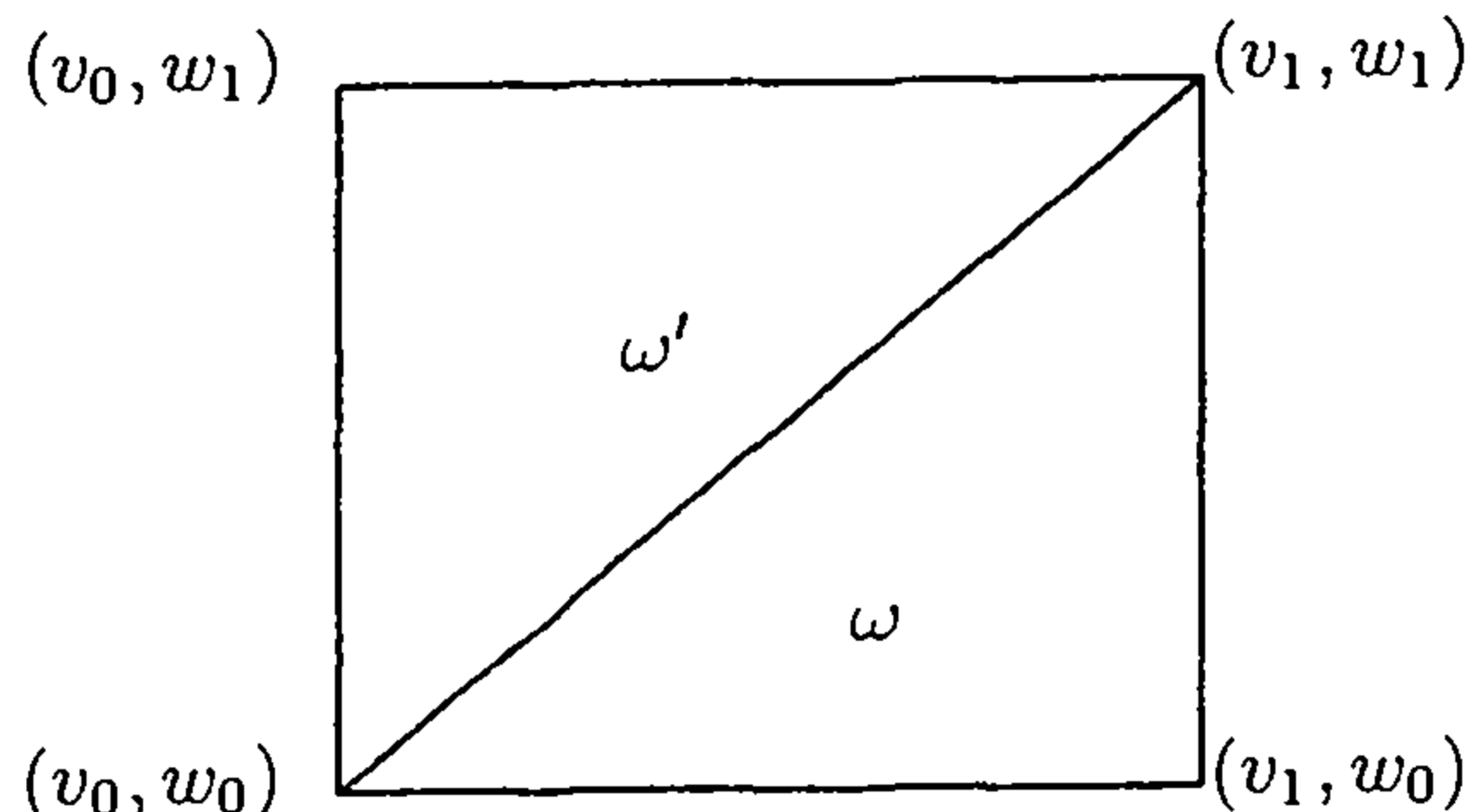

$$\omega = \langle (v_0, w_0), (v_1, w_0), (v_1, w_1) \rangle$$

$$\omega' = \langle (v_0, w_0), (v_0, w_1), (v_1, w_1) \rangle$$

In general $\Delta^p \times \Delta^q$ decomposes as the union of all the linear $(p+q)$ -simplices ω of the form

$$\omega = \langle (v_{\alpha(0)}, w_{\beta(0)}), \dots, (v_{\alpha(i)}, w_{\beta(i)}), \dots, (v_{\alpha(p+q)}, w_{\beta(p+q)}) \rangle, \quad (4.3)$$

where for each i either

$$\begin{cases} \alpha(i+1) = \alpha(i) \\ \beta(i+1) = \beta(i) + 1 \end{cases} \quad \text{or else} \quad \begin{cases} \alpha(i+1) = \alpha(i) + 1 \\ \beta(i+1) = \beta(i). \end{cases}$$

Put $n(\omega) = \sum_{0 \leq i < j < p+q} [\beta(i+1) - \beta(i)][\alpha(j+1) - \alpha(j)]$.

The idea of EZ is that if $\sigma \in S_p(X)$ and $\tau \in S_q(Y)$ are respectively a p -simplex and a q -simplex then the basis element $\sigma \otimes \tau$ in $C_p(X) \otimes C_q(Y)$ should correspond to the map $\sigma \times \tau : \Delta^p \times \Delta^q \rightarrow X \times Y$. Thus while the fact that $\Delta^p \times \Delta^q$ decomposes as the union of the ω motivates us, we do not actually need it. We simply write down the chain

$$c_{p,q} = \sum_{\omega} (-1)^{n(\omega)} \omega \in C_*(\Delta^p \times \Delta^q),$$

where the sum is over all ω of the form (4.3). Notice that if σ or τ is degenerate then so is $CS_*(\sigma \times \tau)(c_{p,q})$, and so it represents zero in $C_*(X \times Y)$. Thus we may define EZ by

$$EZ(\sigma \otimes \tau) = C_*(\sigma \times \tau)(c_{p,q}).$$

Straightforward (but often tedious) calculations establish the properties below of AW and EZ . Let $p^X : X \times Y \rightarrow X$ and $p^Y : X \times Y \rightarrow Y$ be the projections. We identify $X = X \times \{pt\}$ and p^X with $id \times \text{const.} : X \times Y \rightarrow X \times \{pt\}$. On the algebraic side we identify $C_*(X; \mathbb{k}) \otimes C_*(\{pt\}; \mathbb{k}) = C_*(X; \mathbb{k}) \otimes \mathbb{k} = C_*(X; \mathbb{k})$.

- [118] AW and EZ are morphisms of chain complexes, natural in X and in Y . (4.4)

- In particular,

$$\begin{aligned} & (id \otimes \varepsilon) \circ AW = C_*(p^X) \text{ and } (\varepsilon \otimes id) \circ AW = C_*(p^Y); \\ \text{while} & \\ & C_*(p^X) \circ EZ = id \otimes \varepsilon \text{ and } C_*(p^Y) \circ EZ = \varepsilon \otimes id. \end{aligned} \tag{4.5}$$

- When $X = \{pt\}$, AW and EZ both reduce to the identity map of $C_*(Y; \mathbb{k})$. A similar assertion holds when $Y = \{pt\}$. (4.6)

- [118] *Associativity* For any three spaces X, Y, Z ,

$$\begin{aligned} (AW \otimes id) \circ AW &= (id \otimes AW) \circ AW, \quad \text{and} \\ EZ \circ (EZ \otimes id) &= EZ \circ (id \otimes EZ). \end{aligned} \tag{4.7}$$

as maps between $C_*(X \times Y \times Z; \mathbb{k})$ and $C_*(X; \mathbb{k}) \otimes C_*(Y; \mathbb{k}) \otimes C_*(Z; \mathbb{k})$.

- [118] *Interchange of factors* For topological spaces X, Y and graded modules M, N define $\theta : X \times Y \rightarrow Y \times X$ by $\theta(x, y) = (y, x)$ and $\theta_{\text{alg}} : M \otimes N \rightarrow N \otimes M$ by $\theta_{\text{alg}}(m \otimes n) = (-1)^{\deg m \deg n} n \otimes m$. Then

$$C_*(\theta) \circ EZ = EZ \circ \theta_{\text{alg}} : C_*(X; \mathbb{k}) \otimes C_*(Y; \mathbb{k}) \rightarrow C_*(Y \times X; \mathbb{k}). \tag{4.8}$$

- [49] *Compatibility* The following diagram commutes

$$\begin{array}{ccc} C_*(X \times X'; \mathbb{k}) \otimes C_*(Y \times Y'; \mathbb{k}) & \xrightarrow{\Phi \circ (AW \otimes AW)} & C_*(X; \mathbb{k}) \otimes C_*(Y; \mathbb{k}) \otimes C_*(X'; \mathbb{k}) \otimes C_*(Y'; \mathbb{k}) \\ EZ \downarrow & & \downarrow EZ \otimes EZ \\ C_*(X \times X' \times Y \times Y'; \mathbb{k}) & \xrightarrow{AW \circ C_*(id \times \theta \times id)} & C_*(X \times Y; \mathbb{k}) \otimes C_*(X' \times Y'; \mathbb{k}) \end{array} \tag{4.9}$$

where $\Phi = id \otimes \theta_{\text{alg}} \otimes id$.

Finally we have

Proposition 4.10 AW and EZ are inverse chain equivalences. In fact, $AW \circ EZ = id$ and $EZ \circ AW$ is naturally homotopic to the identity.

proof: The first assertion is a simple computation, depending on the fact that we have divided by the degenerate simplices. For the second, we have to construct $h : C_n(X \times Y; \mathbb{k}) \rightarrow C_{n+1}(X \times Y; \mathbb{k})$, natural in X and Y , such that $EZ \circ AW - id = dh + hd$. We may set $h = 0$ in $C_0(X \times Y)$. Suppose for some $n \geq 1$ that h is constructed for $i < n$. Let $\Delta_{\text{top}} : \Delta^n \rightarrow \Delta^n \times \Delta^n$ be the diagonal, regarded as a singular n -simplex. Then $z = (EZ \circ AW)(\Delta_{\text{top}}) - \Delta_{\text{top}} - hd(\Delta_{\text{top}})$ is a cycle in $C_n(\Delta^n \times \Delta^n; \mathbb{k})$. Since $\Delta^n \times \Delta^n$ is contractible we may find $c_{n+1} \in C_{n+1}(\Delta^n \times \Delta^n; \mathbb{k})$ such that $z = dc_{n+1}$.

$\Delta^n; \mathbb{k}$) so that $dc_{n+1} = z$. Now for any n -simplex $(\sigma, \tau) : \Delta^n \rightarrow X \times Y$ define $h(\sigma, \tau) = C_*(\sigma \times \tau)(c_{n+1})$. \square

The Alexander-Whitney map defines a natural differential graded coalgebra structure in $C_*(X; \mathbb{k})$ via the topological diagonal, $\Delta_{\text{top}} : X \rightarrow X \times X$, $x \mapsto (x, x)$. The comultiplication is given by

$$\Delta = AW \circ C_*(\Delta_{\text{top}}) : C_*(X; \mathbb{k}) \rightarrow C_*(X; \mathbb{k}) \otimes C_*(X; \mathbb{k}).$$

Thus for each $\sigma \in S_n(X)$,

$$\Delta(\sigma) = AW(\sigma, \sigma) = \sum_{k=0}^n \sigma \circ \langle e_0, \dots, e_k \rangle \otimes \sigma \circ \langle e_k, \dots, e_n \rangle.$$

The augmentation is defined by

$$\varepsilon = C_*(\text{const.}) : C_*(X; \mathbb{k}) \rightarrow \mathbb{k} = C_*(\{pt\}; \mathbb{k}).$$

The associativity of AW and its compatibility with ε (cf. (b) above) imply that $(C_*(X; \mathbb{k}), \Delta, \varepsilon)$ is a dgc.

Moreover any $x \in X$ may be regarded as a zero-simplex in $C_0(X; \mathbb{k})$ and, clearly $\Delta x = x \otimes x$. Thus $1 \mapsto x$ defines a co-augmentation in the dgc, $C_*(X; \mathbb{k})$.

(c) Pairs, excision, homotopy and the Hurewicz homomorphism.

For $A \subset X$ we put

$$C_*(X, A; \mathbb{k}) = C_*(X; \mathbb{k}) / C_*(A; \mathbb{k});$$

it is \mathbb{k} -free on the non-degenerate simplices of X whose image is not in A . Its homology, $H_*(X, A; \mathbb{k})$ is the ordinary relative singular homology.

For $B \subset A \subset X$ we have the short exact sequence

$$0 \rightarrow C_*(A, B; \mathbb{k}) \rightarrow C_*(X, B; \mathbb{k}) \rightarrow C_*(X, A; \mathbb{k}) \rightarrow 0$$

induced by the obvious inclusions; it leads to a long exact homology sequence

$$\dots \rightarrow H_i(A, B; \mathbb{k}) \rightarrow H_i(X, B; \mathbb{k}) \rightarrow H_i(X, A; \mathbb{k}) \xrightarrow{\partial} H_{i-1}(A, B; \mathbb{k}) \rightarrow \dots \quad (4.11)$$

∂ is called the *connecting homomorphism*. Since $H_*(Y; \mathbb{k}) = H_*(Y, \phi; \mathbb{k})$ this reduces to a more familiar long exact sequence when $B = \phi$.

If $W \subset A \subset X$ has the property that the closure of W is contained in the interior of A , then the *excision property* [142] states that inclusion induces an isomorphism

$$H_*(X - W, A - W; \mathbb{k}) \xrightarrow{\cong} H_*(X, A; \mathbb{k}).$$

The morphisms EZ and AW of (b) above factor to give (relative) Eilenberg-Zilber and Alexander-Whitney morphisms

$$C_*(X, A; \mathbb{k}) \otimes C_*(Y; \mathbb{k}) \begin{array}{c} \xleftarrow{EZ} \\ \xrightarrow{AW} \end{array} C_*(X \times Y, A \times Y; \mathbb{k})$$

satisfying $AW \circ EZ = id$ and $EZ \circ AW \sim id$. Thus these are quasi-isomorphisms.

Suppose now that $\Phi : X \times I \rightarrow Y$ is a homotopy from φ_0 to φ_1 . Define $h : C_i(X; \mathbb{k}) \rightarrow C_{i+1}(Y; \mathbb{k})$, $i \geq 0$, by $h(\sigma) = (-1)^i C_*(\Phi) \circ EZ(\sigma \otimes id_I)$, where the identity map of I , id_I , is regarded as a singular 1-simplex. Then

$$C_*(\varphi_1) - C_*(\varphi_0) = dh + hd;$$

i.e., h is a homotopy from $C_*(\varphi_0)$ to $C_*(\varphi_1)$. In particular $H_*(\varphi_1) = H_*(\varphi_0)$.

As an example, let $\partial\Delta^n$ be the boundary of Δ^n , and regard the identity map $\Delta^n \xrightarrow{\cong} \Delta^n$ as a singular simplex. It represents a cycle, $z_n \in C_n(\Delta^n, \partial\Delta^n; \mathbb{k})$, whose homology class will be denoted by $[\Delta^n]$.

Lemma 4.12 *For $n \geq 0$, $H_*(\Delta^n, \partial\Delta^n; \mathbb{k})$ is a free module concentrated in degree n with single basis element $[\Delta^n]$*

$$H_*(\Delta^n, \partial\Delta^n; \mathbb{k}) = \mathbb{k} \cdot [\Delta^n].$$

proof: We may suppose $n > 0$. Regard $\Delta^{n-1} = \text{Im}\langle e_0, \dots, e_{n-1} \rangle$ as one of the faces of Δ^n and let L be the union of the other faces. Then L is contractible to e_n . Hence $H_*(L; \mathbb{k}) \xrightarrow{\cong} H_*(\Delta^n; \mathbb{k})$, and the long exact sequence for $\phi \subset L \subset \Delta^n$ implies that $H_*(\Delta^n, L; \mathbb{k}) = 0$. Thus the long exact sequence for $L \subset \partial\Delta^n \subset \Delta^n$ provides an isomorphism

$$\partial : H_*(\Delta^n, \partial\Delta^n; \mathbb{k}) \xrightarrow{\cong} H_{*-1}(\partial\Delta^n, L; \mathbb{k}).$$

On the other hand, shrinking the last coordinate shows that the inclusion $(\Delta^{n-1}, \partial\Delta^{n-1}) \rightarrow (\partial\Delta^n - \{e_n\}, L - \{e_n\})$ is a homotopy equivalence. This yields

$$H_*(\partial\Delta^n, L; \mathbb{k}) \xleftarrow[\text{excision}]{\cong} H_*(\partial\Delta^n - \{e_n\}, L - \{e_n\}; \mathbb{k}) \xleftarrow{\cong} H_*(\Delta^{n-1}, \partial\Delta^{n-1}; \mathbb{k})$$

Combined with the isomorphism above this gives an isomorphism

$$H_*(\Delta^n, \partial\Delta^n; \mathbb{k}) \cong H_{*-1}(\Delta^{n-1}, \partial\Delta^{n-1}; \mathbb{k}),$$

which carries $[\Delta^n]$ to $(-1)^n[\Delta^{n-1}]$. The lemma follows by induction on n . \square

It follows from Lemma 4.12 and the long exact sequence for $\phi \subset \partial\Delta^n \subset \Delta^n$ that for $n \geq 1$, $H_*(\partial\Delta^n; \mathbb{k})$ is a free \mathbb{k} -module on two generators

$$H_*(\partial\Delta^n; \mathbb{k}) = \mathbb{k} \cdot [e_0] \oplus \mathbb{k} \cdot [\partial\Delta^n] \tag{4.13}$$

where $[e_0]$ is the homology class of the 0-simplex e_0 and $[\partial\Delta^n]$ is the homology class of the cycle $z_{n-1} = \sum_{i=0}^n (-1)^i \langle e_0 \dots \hat{e}_i \dots e_n \rangle$. Since $(\Delta^n, \partial\Delta^n)$ is homeomorphic to (D^n, S^{n-1}) we conclude

$$H_i(D^n, S^{n-1}; \mathbb{k}) = \begin{cases} \mathbb{k}, & i = n \\ 0, & \text{otherwise} \end{cases}$$

and $\tag{4.14}$

$$H_j(S^m, \{pt\}; \mathbb{k}) = \begin{cases} \mathbb{k}, & j = m \\ 0, & \text{otherwise.} \end{cases}$$

We use a different calculation to fix a generator in $H_m(S^m; \mathbb{Z}) \cong \mathbb{Z}$, $m \geq 1$. Recall that I^m denotes the m -cube. In Example 5, §1 we constructed homeomorphisms

$$I^m / \partial I^m \xrightarrow{\cong} S^m \quad \text{and} \quad \partial I^{m+1} \xrightarrow{\cong} S^m,$$

and so (4.14) implies that $H_m(I^m, \partial I^m; \mathbb{Z}) \cong \mathbb{Z}$. Choose generators $[I^m] \in H_m(I^m, \partial I^m; \mathbb{Z})$ as follows. For $m = 1$ let $[I] \in H_1(I, \partial I; \mathbb{Z})$ be the class represented by the identity map ι of I ($\iota : t \mapsto t$), which is indeed a relative cycle. For $m > 1$ let $[I^m]$ be the class represented by EZ ($\iota \otimes \cdots \otimes \iota$). Then $[I^m]$ is a generator of $H_m(I^m, \partial I^m; \mathbb{Z})$ and $\partial[I^{m+1}]$ is a generator of $H_m(\partial I^{m+1}; \mathbb{Z})$. A straightforward calculation shows that the homeomorphisms above send $[I^m]$ and $\partial[I^{m+1}]$ to the same generator, $[S^m] \in H_m(S^m; \mathbb{Z})$.

Definition $[S^m]$ is called the *fundamental class* of S^m .

Next, recall that $H_m(\varphi) : H_m(S^m; \mathbb{k}) \rightarrow H_m(X; \mathbb{k})$ depends only on the homotopy class of $\varphi : S^m \rightarrow X$. Thus set maps

$$hur_X : \pi_m(X, x_0) \rightarrow H_m(X; \mathbb{k}), \quad m \geq 1,$$

are defined by $hur_X[\varphi] = H_m(\varphi)[S^m]$. A straightforward computation shows that these are group homomorphisms, and it is immediate from the definition that they are natural: if $f : (X, x_0) \rightarrow (Y, y_0)$ is continuous then

$$H_*(f) \circ hur_X = hur_Y \circ \pi_*(f).$$

Definition The *Hurewicz homomorphism* for X is the homomorphism $hur_X : \pi_*(X, x_0) \rightarrow H_*(X; \mathbb{k})$.

(d) Weak homotopy equivalences.

We shall rely heavily on

Theorem 4.15 *If $\varphi : X \rightarrow Y$ is a weak homotopy equivalence then $C_*(\varphi) : C_*(X; \mathbb{k}) \rightarrow C_*(Y; \mathbb{k})$ is a quasi-isomorphism.*

proof: Recall the face maps $\lambda_i = \langle e_0 \dots \hat{e}_i \dots e_n \rangle : \Delta^{n-1} \rightarrow \Delta^n$. We first observe that for each $n \geq 0$ and each $\sigma : \Delta^n \rightarrow Y$ we can associate $\sigma' : \Delta^n \rightarrow X$ and a homotopy $\Phi_\sigma : \Delta^n \times I \rightarrow Y$ from σ to $\varphi \circ \sigma'$ such that

$$\sigma' \circ \lambda_i = (\sigma \circ \lambda_i)' \quad \text{and} \quad \Phi_\sigma \circ (\lambda_i \times id) = \Phi_{\sigma \circ \lambda_i}, \quad 0 \leq i \leq n \quad (4.16)$$

Indeed we proceed by induction on n . Conditions (4.16) define σ' on $\partial\Delta^n$ and Φ_σ on $\partial\Delta^n \times I$. Now the extension to σ' and Φ_σ is just the Whitehead lifting lemma 1.5.

Define a linear map $f : CS_*(Y; \mathbb{k}) \rightarrow CS_*(X; \mathbb{k})$ by $\sigma \mapsto \sigma'$. The conditions above imply that f is a chain map and that $CS_*(\varphi) \circ f - id = hd + dh$, where $h(\sigma) = CS_*(\Phi_\sigma) \circ EZ(\sigma \otimes id_I)$.

A second application of the Whitehead lemma gives, for each $\tau : \Delta^n \rightarrow X$, a homotopy $\Psi_\tau : \Delta^n \times I \rightarrow X$ from $(\varphi \circ \tau)'$ to τ such that $\Psi_\tau \circ (\lambda_i \times id) = \Psi_{\tau \circ \lambda_i}$, $0 \leq i \leq n$. This then implies that $f \circ CS_*(\varphi) - id = dk + kd$. Hence $CS_*(\varphi)$ is a chain equivalence and $C_*(\varphi)$ is a quasi-isomorphism. \square

(e) Cellular homology and the Hurewicz theorem.

Let (X, A) be a relative CW complex with n -skeleton X_n , so that $X_n = X_{n-1} \cup_{f_n} \left(\coprod_{\alpha} D_{\alpha}^n \right)$. Let o_{α} be the origin (centre) of D_{α}^n . Put $U = X_n - \coprod_{\alpha} \{o_{\alpha}\}$ and $O = \coprod_{\alpha} (D_{\alpha}^n - \{o_{\alpha}\})$. Since $D^n - \{0\} = S^{n-1} \times (0, 1] \simeq S^{n-1} \times \{1\}$, it follows that the inclusions $X_{n-1} \rightarrow U$ and $\coprod_{\alpha} S_{\alpha}^{n-1} \rightarrow O$ are homotopy equivalences.

Thus in the diagram

$$\begin{array}{ccccc}
 C_*(X_n, X_{n-1}) & \longrightarrow & C_*(X_n, U) & \longleftarrow & C_*(X_n - X_{n-1}, U - X_{n-1}) \\
 \uparrow & & \uparrow & & \uparrow \cong \\
 C_*\left(\coprod_{\alpha} D_{\alpha}^n, \coprod_{\alpha} S_{\alpha}^{n-1}\right) & \longrightarrow & C_*\left(\coprod_{\alpha} D_{\alpha}^n, O\right) & \longleftarrow & C_*\left(\coprod_{\alpha} D_{\alpha}^n - S_{\alpha}^{n-1}, O - \coprod_{\alpha} S_{\alpha}^{n-1}\right)
 \end{array}$$

where $C_*(-)$ stands for $C_*(-; \mathbb{k})$, the horizontal arrows on the left are quasi-isomorphisms, while the horizontal arrows on the right are quasi-isomorphisms by excision. Hence the characteristic map induces an isomorphism in homology: $\bigoplus_{\alpha} H_*(D_{\alpha}^n, S_{\alpha}^{n-1}) \xrightarrow{\cong} H_*(X_n, X_{n-1}; \mathbb{k})$.

By (4.14) we may identify $H_*(X_n, X_{n-1}; \mathbb{k})$ as a free module concentrated in degree n with basis $\{c_{\alpha}\}$ indexed by the n -cells of X . This implies via an easy induction that $H_*(X_k, X_r; \mathbb{k})$ is concentrated in degrees $i \in (r, k]$. Since any singular simplex of X has compact image it lies in some X_k , and so any element of $C_*(X; \mathbb{k})$ is in some $C_*(X_k; \mathbb{k})$. It follows that

$$H_i(X, X_r; \mathbb{k}) = 0, \quad i \leq r. \tag{4.17}$$

Denote the free module, $H_*(X_n, X_{n-1}; \mathbb{k})$ by C_n . Associated with the inclusions $X_{n-1} \subset X_n \subset X_{n+1}$ is a long exact homology sequence, (cf. (4.11)) with connecting homomorphism $\partial : C_{n+1} \rightarrow C_n$. An easy computation shows that $\partial \circ \partial = 0$. Thus $(C = \{C_n\}_{n \geq 0}, \partial)$ is a chain complex. It is called the *cellular chain complex* for the relative CW complex, (X, A) .

Definition A *cellular chain model* for (X, A) is a morphism

$$m : (C, \partial) \rightarrow C_*(X, A; \mathbb{k})$$

between the cellular and normalized singular chain complexes, restricting to morphisms $m(n) : (C_{\leq n}, \partial) \rightarrow C_*(X_n, A; \mathbb{k})$ and such that the induced morphisms

$$\bar{m}(n) : (C_n, 0) = (C_{\leq n}/C_{\leq n-1}, \partial) \rightarrow C_*(X_n, X_{n-1}; \mathbb{k})$$

induce the identity map $C_n = H_*(X_n, X_{n-1}; \mathbb{k})$.

When $A = \emptyset$, $m : (C, \partial) \rightarrow C_*(X; \mathbb{k})$ is called a *cellular model for the CW complex X*.

Theorem 4.18 (Cellular chain models) *Every relative CW complex (X, A) has a cellular chain model $m : (C_*, \partial) \rightarrow C_*(X, A; \mathbb{k})$, and m and each $m(n)$ are always quasi-isomorphisms.*

proof: We construct the morphisms $m(n)$ inductively and observe in passing that they are quasi-isomorphisms.

Suppose by induction that $m(n)$ is constructed; we extend it to $m(n+1)$ as follows. Represent a basis element $c_\alpha \in C_{n+1}$ by a cycle $z_\alpha \in C_{n+1}(X_{n+1}, X_n; \mathbb{k})$, and lift z_α to a chain $w_\alpha \in C_{n+1}(X_{n+1}; \mathbb{k})$. Then dw_α is an n -cycle in $C_*(X_n; \mathbb{k})$. Since $m(n)$ is a quasi-isomorphism there is a cycle $v_\alpha \in C_n$ and a chain $a_\alpha \in C_{n+1}(X_n; \mathbb{k})$ such that $m(n)(v_\alpha) = dw_\alpha + da_\alpha$. Since $H(\bar{m}(n))$ is the identity, it is immediate that $v_\alpha = \partial c_\alpha$. Extend $m(n)$ to a morphism $m(n+1)$ by setting $m(n+1)(c_\alpha) = w_\alpha + a_\alpha$. Since $w_\alpha + a_\alpha$ also projects to z_α , $\bar{m}(n+1)(c_\alpha) = z_\alpha$ and $H(\bar{m}(n+1))c_\alpha = [z_\alpha] = c_\alpha$, as desired.

Finally, since $H(m(n))$ and $H(\bar{m}(n+1))$ are isomorphisms so is $H(m(n+1))$ by the five lemma (3.1). The sequence $m(n)$ so constructed defines a cellular model $m : (C_*, \partial) \rightarrow C_*(X, A; \mathbb{k})$. Moreover for any cellular model we have, in the same way, that each $m(n)$ is a quasi-isomorphism. Formula (4.17) identifies $H_i(m(n))$ with $H_i(m)$ for $i < n$; hence m is a quasi-isomorphism. \square

Remark Suppose $\varphi : (X, A) \rightarrow (Y, B)$ is a cellular map of relative CW complexes, so that it restricts to maps $\varphi(n, k) : (X_n, X_k) \rightarrow (Y_n, Y_k)$. Put $f_n = H_n(\varphi(n, n-1)) : H_n(X_n, X_{n-1}; \mathbb{k}) \rightarrow H_n(Y_n, Y_{n-1}; \mathbb{k})$. It is immediate from the definition of ∂ as a connecting homomorphism that

$$f = \{f_n\} : (C_*^X, \partial) \rightarrow (C_*^Y, \partial)$$

is a morphism from the cellular chain complex of (X, A) to the cellular chain complex of (Y, B) .

Now suppose that $m^X : (C_*^X, \partial) \xrightarrow{\cong} C_*(X, A; \mathbb{k})$ and $m^Y : (C_*^Y, \partial) \xrightarrow{\cong} C_*(Y, B; \mathbb{k})$ are cellular chain models. We construct linear maps $h_n : C_n^X \rightarrow C_{n+1}(Y_n; \mathbb{k})$ so that

$$m^Y f - C_*(\varphi)m^X = dh + h\partial : (C_*^X, \partial) \rightarrow C_*(Y, B; \mathbb{k});$$

i.e., $m^Y f$ is chain homotopic to $C_*(\varphi)m^X$.

In fact, set $h_{-1} = 0$ and assume h_i constructed for $i \leq n$ so that the equation above holds in $C_{\leq n}^X$. Let c_α be a basis element of C_{n+1}^X . Then

$$\begin{aligned} & d(m^Y f - C_*(\varphi)m^X - h\partial)c_\alpha \\ &= (m^Y f - C_*(\varphi)m^X - dh - h\partial)\partial c_\alpha \\ &= 0. \end{aligned}$$

Thus $z_\alpha = (m^Y f - C_*(\varphi)m^X - h\partial)c_\alpha$ is a cycle in $C_{n+1}(Y_{n+1}; \mathbb{k})$. Now $h\partial c_\alpha \in h(C_n^X) \subset C_{n+1}(Y_n; \mathbb{k})$. It follows that z_α projects to the cycle $(m^Y f - C_*(\varphi)m^X)c_\alpha$ in $C_{n+1}(Y_{n+1}, Y_n; \mathbb{k})$. It is immediate from the definitions that this relative cycle is a boundary, so that

$$z_\alpha = dx_\alpha + y_\alpha, \quad x_\alpha \in C_{n+2}(Y_{n+1}; \mathbb{k}), \quad y_\alpha \in C_{n+1}(Y_n; \mathbb{k}).$$

Now y_α is an $(n+1)$ -cycle in Y_n . Since $H_{n+1}(Y_n; \mathbb{k}) = 0$ by the Cellular chain models theorem, $y_\alpha = dw_\alpha$, some $w_\alpha \in C_{n+2}(Y_{n+1}; \mathbb{k})$. Define h_{n+1} by setting $h_{n+1}(c_\alpha) = w_\alpha$.

Theorem 4.19 (Hurewicz) *Let (X, x_0) be a pointed topological space for which $\pi_i(X, x_0) = 0, i \leq r$.*

(i) *If $r = 0$ (i.e., X is path connected), then the homomorphism*

$$hur_X : \pi_1(X, x_0) \longrightarrow H_1(X; \mathbb{Z})$$

is surjective and its kernel is the subgroup of π_1 generated by the commutators $\alpha\beta\alpha^{-1}\beta^{-1}$.

(ii) *If $r \geq 1$, then $H_i(X; \mathbb{Z}) = 0, 1 < i \leq r$ and*

$$hur_X : \pi_{r+1}(X, x_0) \longrightarrow H_{r+1}(X; \mathbb{Z})$$

is an isomorphism.

proof: The proof of Theorem 1.4 provides a weak homotopy equivalence

$$\varphi : (Y, y_0) \longrightarrow (X, x_0)$$

in which Y is a CW complex, $Y_r = y_0$ and $Y_{r+1} = \bigvee_\alpha S_\alpha^{r+1}$. Thus Theorem 4.15 asserts that $H_*(\varphi)$ is an isomorphism. By the naturality of the Hurewicz homomorphism it is sufficient to prove the theorem for Y . Moreover, again by naturality, it is sufficient to prove the theorem for the finite subcomplexes of Y ; i.e. we may assume Y itself is finite.

We first consider the case $r \geq 1$ and observe that the Cellular chain models theorem above shows that $H_i(Y; \mathbb{Z}) = 0, 1 \leq i \leq r$. Moreover, since $S^{r+1} = * \cup e^{r+1} : \prod_\alpha S_\alpha^{r+1}$ is a CW complex with Y_{r+1} as its $(r+1)$ skeleton and the

next smallest cells of dimension $2r + 2$. Thus (since $r \geq 1$) there are no $r + 2$ -cells, and so the Cellular approximation theorem 1.1 implies that $\pi_{r+1}(Y_{r+1}) \xrightarrow{\cong} \pi_{r+1}(\prod_{\alpha} S_{\alpha}^{r+1})$. By Hopf's theorem 1.3, this identifies $\pi_{r+1}(Y_{r+1})$ as a free abelian group with basis $\{[\lambda_{\alpha}]\}$ where $\lambda_{\alpha} : S_{\alpha}^{r+1} \rightarrow Y_{r+1}$ is the inclusion. Hence

$$hur' : \pi_{r+1}(Y_{r+1}) \rightarrow H_{r+1}(Y_{r+1}; \mathbb{Z})$$

is an isomorphism, hur' denoting the Hurewicz homomorphism for Y_{r+1} .

Let $\lambda : Y_{r+1} \rightarrow Y$ be the inclusion. Since $H(Y, Y_{r+1}; \mathbb{Z})$ vanishes in degrees $k \leq r + 1$ (cf (4.17)), $H_{r+1}(\lambda)$ is surjective. Now the commutative diagram

$$\begin{array}{ccc} \pi_{r+1}(Y_{r+1}) & \xrightarrow[\cong]{hur'} & H_{r+1}(Y_{r+1}; \mathbb{Z}) \\ \pi_{r+1}(\lambda) \downarrow & & \downarrow H_{r+1}(\lambda) \\ \pi_{r+1}(Y) & \xrightarrow{hur_Y} & H_{r+1}(Y; \mathbb{Z}) \end{array}$$

shows that hur_Y is surjective.

Write $Y_{r+2} = Y_{r+1} \cup (\cup_{\beta} e_{\beta}^{r+2})$ with attaching maps $f_{\beta} : S_{\beta}^{r+1} \rightarrow Y_{r+1}$. Let (C, ∂) be the cellular chain complex for Y . If $c_{\beta} \in C_{r+2}$ is the basis element corresponding to e_{β}^{r+2} , then a straightforward computation, using the definition of ∂ as a connecting homomorphism, shows that $\partial c_{\beta} = H_{r+1}(f_{\beta})[S_{\beta}^{r+1}]$. Thus it follows from the Cellular chain models theorem that the kernel of $H_{r+1}(\lambda)$ is spanned by the classes $H_{r+1}(f_{\beta})[S_{\beta}^{r+1}]$.

Now suppose $g : (S^{r+1}, *) \rightarrow (Y, y_0)$ represents an element in $\ker hur_Y$. By the Cellular approximation theorem, g is based homotopic to $h : S^{r+1} \rightarrow Y_{r+1}$; i.e., $[g] = \pi_{r+1}(\lambda)[h]$ and $0 = H_{r+1}(\lambda) hur'[h]$. Thus

$$hur'[h] = \sum_{\beta} k_{\beta} H_{r+1}(f_{\beta})[S_{\beta}^{r+1}] = \sum_{\beta} k_{\beta} hur'[f_{\beta}].$$

Since hur' is an isomorphism,

$$[h] = \sum_{\beta} k_{\beta} [f_{\beta}].$$

But f_{β} is the attaching map for a cell in Y_{r+2} , and so $\pi_{r+1}(\lambda)[f_{\beta}] = 0$. It follows that $[g] = \pi_{r+1}(\lambda)[h] = 0$ and so hur is injective.

In the case $r = 0$, $Y_1 = \vee_{\alpha} S_{\alpha}^1$ and the van Kampen theorem [68] implies that $\pi_1(Y_1)$ is generated by the circles S_{α}^1 . These same circles form a basis of the free abelian group $H_1(Y_1; \mathbb{Z})$, and it follows that $\ker hur'$ is generated by the commutators. Now simple modification of the proof for $r \geq 1$ completes the argument. \square

(f) Eilenberg-MacLane spaces.

An *Eilenberg-MacLane space of type* (π, n) , $n \geq 1$, consists of

- A path connected, based space (X, x_0) such that $\pi_i(X, x_0) = 0$, $i \neq n$, together with
- A specified isomorphism of $\pi_n(X, x_0)$ with a given group π .

If X is a CW complex it is called *cellular Eilenberg-MacLane space*. Eilenberg-MacLane spaces are often denoted by $K(\pi, n)$. Here we shall need two simple properties.

Proposition 4.20 *Suppose given an $(n-1)$ -connected based CW complex (X, x_0) , an Eilenberg-MacLane space $(K(\pi, n), *)$ and a homomorphism $\sigma : \pi_n(X, x_0) \rightarrow \pi$. Then there is a unique homotopy class of maps*

$$g : (X, x_0) \rightarrow (K(\pi, n), *)$$

such that $\pi_n(g) = \sigma$.

proof: The proof of the Cellular models theorem 1.4 shows that (X, x_0) has the weak homotopy of a CW complex with a single 0-cell, no cells in dimension i , $1 \leq i < n$, and all cells attached by based maps $(S^k, *) \rightarrow (X_k, x_0)$. Since weak homotopy equivalences between CW complexes are homotopy equivalences (Corollary 1.7) we may assume (X, x_0) itself satisfies this condition. Thus $X_n = \bigvee_{\alpha} S_{\alpha}^n$, and $X_{n+1} = \bigvee_{\alpha} S_{\alpha}^n \cup_f \coprod_{\beta} D_{\beta}^{n+1}$.

Now S_{α}^n represents a class $\gamma_{\alpha} \in \pi_n(X, x_0)$; choose $g_n : (\bigvee_{\alpha} S_{\alpha}^n, x_0) \rightarrow (K(\pi, n), *)$ so that g_n restricted to S_{α}^n represents $\sigma(\gamma_{\alpha})$. If $\lambda : X_n \rightarrow X$ is the inclusion then $\pi_n(g_n) = \sigma \circ \pi_n(\lambda)$, and it follows that $g_n \circ f : (S_{\beta}^n, *) \rightarrow (K(\pi, n), *)$ is null homotopic. This permits us to extend g_n to a map $g_{n+1} : X_{n+1} \rightarrow K(\pi, n)$. Extend g_{n+1} to the rest of X inductively over the skeleta, using the fact that $\pi_i(K(\pi, n)) = 0$, $i > n$.

Given a second such map h we use the fact that $\pi_n(h) = \pi_n(g)$ to conclude that $h_n \sim g_n : (X_n, x_0) \rightarrow (K(\pi, n), *)$. Extend the homotopy H inductively over the skeleta: if H is defined in $X_k \times I$ and D^{k+1} is a $(k+1)$ disk attached by $S^k \rightarrow X_k$ then H yields a map $S^k \times I \rightarrow K(\pi, n)$. Using h in $D^{k+1} \times \{0\}$ and g in $D^{k+1} \times \{1\}$ we extend to a map $\partial(D^{k+1} \times I) \rightarrow K(\pi, n)$. Since $k \geq n$, $\pi_{k+1}(K(\pi, n)) = 0$ and this map extends to all of $D^{k+1} \times I$, thereby extending H to $X_{k+1} \times I$. \square

Proposition 4.21 *Suppose π is an abelian group. Then there exists a $K(\pi, n)$ and any two have the same weak homotopy type.*

proof: Suppose $n \geq 2$. Write π as the quotient of a free abelian group on generators g_{α} divided by relations r_{β} . The proof of the Hurewicz theorem (4.19) identifies $\pi_n(\bigvee_{\alpha} S_{\alpha}^n) = \bigoplus_{\alpha} \mathbb{Z}g_{\alpha}$. Let $f_{\beta} : (S_{\beta}^n, *) \rightarrow \bigvee_{\alpha} S_{\alpha}^n$ represent r_{β} . Then the proof of the Hurewicz theorem also identifies $\pi_n(\bigvee_{\alpha} S_{\alpha}^n \cup_{\{f_{\beta}\}} \coprod_{\beta} D_{\beta}^{n+1}) = \pi$.

Put $Y_{n+1} = \bigvee_{\alpha} S_{\alpha}^n \cup_{\{f_{\beta}\}} \coprod_{\beta} D_{\beta}^{n+1}$. Now create Y_{n+2} by adding $(n+2)$ -cells to Y_{n+1} to kill $\pi_{n+1}(Y_{n+1})$ and continue this process inductively, creating Y_{k+1}

by adding $(k+1)$ -cells to Y_k to kill $\pi_k(Y_k)$. The Cellular approximation theorem 1.1 will show that Y is a $K(\pi, n)$.

For $n = 1$ we simply note that, since path spaces are contractible, the long exact homotopy sequence (2.2) for the path space fibration implies that $\Omega K(\pi, 2)$ is a $K(\pi, 1)$.

Let (X, x_0) be a cellular model for an Eilenberg-MacLane space (Y, y_0) and suppose $K(\pi, n)$ is any Eilenberg-MacLane space of the same type. Proposition 4.20 gives a map $g : (X, x_0) \rightarrow K(\pi, n)$ such that $\pi_n(g)$ is the identity map of π . Thus φ is a weak homotopy equivalence. \square

Remark When $n = 1$, $K(\pi, 1)$'s exist for *any* group π , and are constructed in the same way: π is the quotient of a free group on generators g_α by relations r_β , and adding corresponding 2-cells to $\vee S_\alpha^1$ gives a space with $\pi_1 = \pi$. For details see [68].) We will not carry this out since such $K(\pi, 1)$'s do not arise in this text.

Exercises

1. Compute the homology with \mathbb{Z} coefficients of the space obtained from the sphere S^n by attaching an $(n+1)$ -cell along a continuous map of degree p and another $(n+1)$ -cell along a continuous map of degree q with p and q relatively prime.
2. Suppose that $I\mathbb{k}$ is a field. Compute the algebra $H^*(S^p \times S^q \times S^r; I\mathbb{k})$ for $1 \leq p \leq q \leq r$.
3. Let X be a finite complex and $I\mathbb{k}$ a field. Prove that $\dim H_*(X, I\mathbb{k}) < \infty$. Using §3-exercise 6, prove that $\chi(X) = \sum_{\sigma \in \text{Cells}} (-1)^{\dim \sigma}$. Compute $\chi(X)$ when $X = S^n, \mathbb{R}P^n, \mathbb{C}P^n, T^2$.
4. Let $X^{(n)}$ be obtained by attaching to a space X cells of dimension $n+2$ and higher to kill off the homotopy groups of X in dimensions above n . Prove that the homotopy fibre of the canonical map $X^{(n+1)} \rightarrow X^{(n)}$ is an Eilenberg-MacLane space $K(\pi_{n+1}(X), n+1)$.
5. Prove that the cap product, $C^p(X; I\mathbb{k}) \otimes C_q(X; I\mathbb{k}) \rightarrow C_{q-p}(X; I\mathbb{k})$, $f \otimes c \mapsto f \cap c = (1 \otimes f)AW(c)$ induces a natural of $C^*(X; I\mathbb{k})$ -module structure on $C_*(X; I\mathbb{k})$.

5 The cochain algebra $C^*(X; \mathbb{k})$

As usual, we work over an arbitrary commutative ground ring, \mathbb{k} .

Recall from §3 that given two complexes (M, d) and (N, d) we can form the complex $(\text{Hom}(M, N), d)$ with $d(f) = df - (-1)^{\deg f} fd$. In particular, the *normalized singular cochain complex* of a topological space X is the cochain complex

$$C^*(X; \mathbb{k}) = \text{Hom}(C_*(X; \mathbb{k}), \mathbb{k}).$$

Thus $C^n(X; \mathbb{k}) = \text{Hom}(C_n(X; \mathbb{k}), \mathbb{k})$ and $d(f) = -(-1)^{\deg f} fd$. In particular, an element $f \in C^n(X; \mathbb{k})$ may be thought of as a set theoretic function $f : S_n(X) \rightarrow \mathbb{k}$ vanishing on the degenerate simplices, and

$$(d(f))(\sigma) = \sum_{i=0}^{n+1} (-1)^{\deg f + i + 1} f(\sigma \circ \langle e_0, \dots, \hat{e}_i, \dots, e_{n+1} \rangle).$$

The augmentation $\varepsilon : C_0(X; \mathbb{k}) \rightarrow \mathbb{k}$ may be regarded as an element $1 \in C^0(X; \mathbb{k})$.

Recall from §4(b) that the Alexander-Whitney comultiplication in $C_*(X; \mathbb{k})$ is defined by $\Delta = AW \circ C_*(\Delta_{\text{top}}) : C_*(X; \mathbb{k}) \rightarrow C_*(X; \mathbb{k}) \otimes C_*(X; \mathbb{k})$. Dually, as described in §3(d), $C^*(X; \mathbb{k})$ is a cochain algebra whose natural associative multiplication, the *cup product*, is defined by

$$\begin{aligned} (f \cup g)(\sigma) &= (f \otimes g)(\Delta\sigma) \\ &= (-1)^{k(n-k)} f(\sigma \circ \langle e_0, \dots, e_k \rangle) g(\sigma \circ \langle e_k, \dots, e_n \rangle), \\ & \quad f \in C^k(X; \mathbb{k}), \quad g \in C^{n-k}(X; \mathbb{k}), \quad \sigma \in S_n(X). \end{aligned}$$

Definition The cochain algebra $C^*(X; \mathbb{k})$ is called the *normalized singular cochain algebra* of X . The cohomology algebra $H(C^*(X; \mathbb{k}))$ is denoted $H^*(X; \mathbb{k})$ and called the *singular cohomology* of X .

If $\varphi : X \rightarrow Y$ is a continuous map then we put $C^*(\varphi) = \text{Hom}(C_*(\varphi); \mathbb{k}) : C^*(Y; \mathbb{k}) \rightarrow C^*(X; \mathbb{k})$. Just as $C_*(\varphi)$ is a morphism of differential graded coalgebras so $C^*(\varphi)$ is a cochain algebra morphism, and $H^*(\varphi) = H(C^*(\varphi))$ is a morphism of graded algebras.

If $A \subset X$ then $C^*(X; \mathbb{k}) \rightarrow C^*(A; \mathbb{k})$ is surjective because (as graded modules) $C_*(A; \mathbb{k})$ is free on a subset of a basis of $C_*(X; \mathbb{k})$. The kernel of this restriction, $C^*(X, A; \mathbb{k})$, is an ideal in $C^*(X; \mathbb{k})$ and the short exact sequence

$$0 \rightarrow C^*(X, A; \mathbb{k}) \rightarrow C^*(X; \mathbb{k}) \rightarrow C^*(A; \mathbb{k}) \rightarrow 0$$

gives rise to a long exact cohomology sequence. Note that $C^*(X, A; \mathbb{k})$ consists of the functions $S_*(X) \rightarrow \mathbb{k}$ that vanish on degenerate simplices and on simplices in A . Thus we may identify the cochain complexes $C^*(X, A; \mathbb{k})$ and

$\text{Hom}(C_*(X, A; \mathbb{k}), \mathbb{k})$. We call $C^*(X, A; \mathbb{k})$ the complex of *normalized relative singular cochains*; $H^*(X, A; \mathbb{k}) = H(C^*(X, A; \mathbb{k}))$ is the *relative singular cohomology*.

Left and right multiplication by $C^*(X; \mathbb{k})$ make $C^*(X, A; \mathbb{k})$ into a left and right $C^*(X; \mathbb{k})$ -module. Thus $H^*(X, A; \mathbb{k})$ is a left and right $H^*(X; \mathbb{k})$ -module.

Let $f \in C^n(X, A; \mathbb{k})$ and $z \in C_n(X, A; \mathbb{k})$ be respectively a cocycle and a cycle. Then $f(z)$ depends only on the cohomology class $[f]$ and the homology class $[z]$. Define

$$\alpha : H^*(X, A; \mathbb{k}) \longrightarrow \text{Hom}(H_*(X, A; \mathbb{k}), \mathbb{k}) \quad (5.1)$$

by $(\alpha[f])[z] = f(z)$. This defines a pairing between H^* and H_* that we denote by $\langle [f], [z] \rangle$, in line with the convention in §3(a).

Next, let $p : (X, A) \times Y \longrightarrow (X, A)$ and $q : X \times Y \longrightarrow Y$ be the projections. Since $H^*((X, A) \times Y; \mathbb{k})$ is a right $H^*(X \times Y; \mathbb{k})$ -module, a linear map

$$\kappa : H^*(X, A; \mathbb{k}) \otimes H^*(Y; \mathbb{k}) \longrightarrow H^*((X, A) \times Y; \mathbb{k}) \quad (5.2)$$

is defined by $\kappa([f] \otimes [g]) = H^*(p)[f] \cdot H^*(q)[g]$.

Proposition 5.3 (i) *If \mathbb{k} is a field then α is always an isomorphism and so $\langle \cdot, \cdot \rangle$ is non-degenerate. In particular, $H^*(X, A; \mathbb{k})$ has finite type if and only if $H_*(X, A; \mathbb{k})$ does.*

(ii) *If \mathbb{k} is a field and at least one of $H_*(X, A; \mathbb{k})$, $H_*(Y; \mathbb{k})$ has finite type then κ is an isomorphism.*

proof: (i) This is just the assertion of Proposition 3.3 that “ H ” commutes with “Hom”.

(ii) As follows from §4(b), the Alexander-Whitney map is a quasi-isomorphism $C_*((X, A) \times Y; \mathbb{k}) \xrightarrow{\cong} C_*(X, A; \mathbb{k}) \otimes C_*(Y; \mathbb{k})$. Since homology commutes with tensor products (Proposition 3.3) we obtain an isomorphism

$$H_*((X, A) \times Y; \mathbb{k}) \xrightarrow{\cong} H_*(X, A; \mathbb{k}) \otimes H_*(Y; \mathbb{k}).$$

Because we have supposed one of $H_*(X, A; \mathbb{k})$, $H_*(Y; \mathbb{k})$ to have finite type, we may identify $H^*(X, A; \mathbb{k}) \otimes H^*(Y; \mathbb{k})$ as the dual of $H_*(X, A; \mathbb{k}) \otimes H_*(Y; \mathbb{k})$, and κ as the isomorphism dual to the isomorphism above. \square

Finally, if $A \subset B \subset X$ then the short exact sequence

$$0 \longrightarrow C^*(X, B; \mathbb{k}) \longrightarrow C^*(X, A; \mathbb{k}) \longrightarrow C^*(B, A; \mathbb{k}) \longrightarrow 0$$

leads to a long exact cohomology sequence dual to (4.11).

Exercises

1. a) Prove that if $A \subset X$ and $B \subset X$ then the cup product $C^*(X; \mathbb{k}) \otimes C^*(X; \mathbb{k}) \rightarrow C^*(X; \mathbb{k})$ restricts to a cup product $C^*(X, A; \mathbb{k}) \otimes C^*(X, B; \mathbb{k}) \rightarrow C^*(X, A \cup B; \mathbb{k})$ and thus induces a cup product $H^*(X, A; \mathbb{k}) \otimes H^*(X, B; \mathbb{k}) \rightarrow H^*(X, A \cup B; \mathbb{k})$.

b) Prove that if A and B are contractible open sets such that $X = A \cup B$ then for any $p > 0$ and $q > 0$, $\cup : H^p(X; \mathbb{k}) \otimes H^q(X; \mathbb{k}) \rightarrow H^{p+q}(X; \mathbb{k})$ is zero

c) Prove that a suspension (reduced or not) has a trivial cohomology algebra.

d) Prove that $\mathbb{C}P^2$ and $S^2 \vee S^4$ do not have the same homotopy type.

2. Suppose that \mathbb{k} is a field. Prove that the morphism κ , defined in 5.2, is an isomorphism of algebras when $A = \emptyset$. Compute the algebra $H^*(X; \mathbb{k})$ when $X = S^1 \times S^1 \times \dots \times S^1$ (n -times), $X = Y \vee Z$, $X = (S^3 \vee S^7) \times (S^5 \vee S^9)$, $X = Y \wedge Z$.

3. Prove that, for $\alpha \in \pi_6(\mathbb{C}P^2 \vee S^2)$, the spaces $X_\alpha = \mathbb{C}P^2 \vee S^2 \cup_\alpha D^7$ have the same cohomology algebra.

4. Prove that if $\dim H_i(X; \mathbb{k}) = \infty$, then $H^i(X; \mathbb{k})$ is uncountable.

6 (R, d) -modules and semifree resolutions

As usual, we work over an arbitrary commutative ground ring, \mathbb{k} . Thus graded module means graded \mathbb{k} -module, linear means \mathbb{k} -linear, and $\text{Hom}(-, -)$ and $- \otimes -$ stand for $\text{Hom}_{\mathbb{k}}(-, -)$ and $- \otimes_{\mathbb{k}} -$.

Our focus in this section is on modules (M, d) over a dga (R, d) as defined in §3. While the emphasis is on left (R, d) -modules the results apply verbatim to right modules. In the classical context of modules M over a ring R (no differentials) it is standard to construct a quasi-isomorphism $(P_*, d) \xrightarrow{\cong} (M, 0)$ from a chain complex of free R -modules to M ; these are the *free resolutions* of M .

Free resolutions were generalized by Avramov and Halperin[16] to modules over a dga (R, d) . Their analogue of the complexes P_* are the *semifree* (R, d) -modules defined below, which have these two important properties:

- Any (R, d) -module admits a quasi-isomorphism from an (R, d) -semifree module.
- Any morphism from an (R, d) -semifree module lifts (up to homotopy) through a quasi-isomorphism.

Thus (cf. introduction to §1) semifree modules over (R, d) are the exact analogues of CW complexes.

This section is organized into the following topics:

- (a) Semifree models.
- (b) Quasi-isomorphism theorems.

(a) Semifree models.

We begin with some basic definitions. Recall the tensor product $N \otimes_R M$ and the module of R -linear maps $\text{Hom}_R(M, M')$ defined in §3(b) for any right R -module N and left R -modules M and M' . If (N, d) , (M, d) and (M', d) are (R, d) -modules then (cf. §3(c))

- $(N \otimes_R M, d)$ is a quotient complex of $(N, d) \otimes (M, d)$, and
- $(\text{Hom}_R(M, M'), d)$ is a subcomplex of $\text{Hom}(M, M')$.

A *morphism* $\varphi : (M, d) \rightarrow (M', d)$ is an R -linear map of degree zero, satisfying $\varphi d = d\varphi$. Two morphisms, φ, ψ , are *homotopic* if $\varphi - \psi = d\theta + \theta d$ for some R -linear map θ ; θ is a *homotopy* and we write $\varphi \sim_R \psi$. Thus morphisms are precisely the cycles of degree zero in $\text{Hom}_R(M, M')$ and two morphisms are homotopic if and only if they represent the same homology class in $H_0(\text{Hom}_R(M, M'))$.

In particular an *equivalence* of (R, d) -modules is a morphism $\varphi : (M, d) \rightarrow (M', d)$ such that for some morphism $\psi : (M', d) \rightarrow (M, d)$ we have $\psi\varphi \sim_R id_M$

and $\varphi\psi \sim_R id_{M'}$. Thus an equivalence is a quasi-isomorphism. The morphism ψ is called an *inverse equivalence*.

In general, a cycle of degree k in $\text{Hom}_R(M, M')$ is an R -linear map f satisfying $d \circ f = (-1)^{\text{deg } f} f \circ d$. It induces the $H(R)$ -linear map $H(f) : H(M) \rightarrow H(M')$ defined by $H(f)[z] = [f(z)]$. Clearly $H(f)$ depends only on the homology class, $[f]$, of f and $[f] \mapsto H(f)$ defines a canonical linear map $H(\text{Hom}_R(M, M')) \rightarrow \text{Hom}_{H(R)}(H(M), H(M'))$.

Finally if W is a graded module then unless otherwise specified $R \otimes W$ will denote the R -module defined by $a \cdot (b \otimes w) = ab \otimes w$. When $w \mapsto 1 \otimes w$ is injective we identify W with the image $1 \otimes W \subset R \otimes W$.

Definition A left (R, d) -module (M, d) is *semifree* if it is the union of an increasing sequence

$$M(0) \subset M(1) \subset \dots \subset M(k) \subset \dots \tag{6.1}$$

of sub (R, d) -modules such that $M(0)$ and each $M(k)/M(k-1)$ are R -free on a basis of cycles (cf. §3). Such an increasing sequence is called a *semifree filtration* of (M, d) .

A *semifree resolution* of an (R, d) -module (Q, d) is an (R, d) -semifree module (M, d) together with a quasi-isomorphism

$$m : (M, d) \xrightarrow{\sim} (Q, d)$$

of (R, d) -modules.

Semifree resolutions play the same role for modules over dga's that ordinary free resolutions do in the ungraded case. Moreover they generalize the classical case: if ungraded objects are regarded as graded objects concentrated in degree zero then free resolutions are examples of semifree resolutions.

Semifree resolutions also play a quite analogous role to that of CW complexes within the category of topological spaces, as will be illustrated shortly by results that mimic several of the theorems in §1. First, however, we make some preliminary observations.

Remark Suppose $\{M(k)\}$ is a semifree filtration of (M, d) . Then $M(0)$ and each $M(k)/M(k-1)$ have the form $(R, d) \otimes (Z(k), 0)$ where $Z(k)$ is a free k -module. Thus the surjections $M(k) \rightarrow R \otimes Z(k)$ split:

$$M(k) = M(k-1) \oplus (R \otimes Z(k)), \quad \text{and} \quad d : Z(k) \rightarrow M(k-1).$$

In particular, if we forget the differentials, $M = R \otimes \left(\bigoplus_{k=0}^{\infty} Z(k) \right)$ is a free R -module.

Lemma 6.2 If $(R, d) \rightarrow (S, d)$ is a morphism of dga's, and if (M, d) is a semifree (R, d) -module then $(S \otimes_R M, d)$ is (S, d) -semifree.

proof: Let $\{M(k)\}$ be a semifree filtration for (M, d) . From the formula in Remark 6.1 we deduce

$$S \otimes_R M(k) = S \otimes_R M(k-1) \oplus (S \otimes Z(k)), \quad d: Z(k) \longrightarrow S \otimes_R M(k-1).$$

This exhibits $\{S \otimes_R M(k)\}$ as a semifree filtration for $(S \otimes_R M, d)$. \square

Lemma 6.3 *Suppose an (R, d) -module (M, d) is the union of an increasing sequence $M(0) \subset M(1) \subset \dots$ of submodules such that $M(0)$ and each $M(k)/M(k-1)$ is (R, d) -semifree. Then (M, d) itself is semifree.*

proof: Put $M(-1) = 0$. In the same way as in the Remark we may write

$$M(k) = M(k-1) \oplus (R \otimes [\bigoplus_{\ell=0}^{\infty} Z(k, \ell)]),$$

with $Z(k, \ell)$ a free graded \mathbb{k} -module and

$$d: Z(k, \ell) \longrightarrow M(k-1) \oplus \left(R \otimes \left[\bigoplus_{i < \ell} Z(k, i) \right] \right).$$

Thus M is R -free on the union $\{z_\alpha\}$ of the bases of the \mathbb{k} -modules $Z(k, \ell)$, with $Z(k, \ell)$ a free graded \mathbb{k} -module and

$$d: Z(k, \ell) \longrightarrow M(k-1) \oplus \left(R \otimes \left[\bigoplus_{i < \ell} Z(k, i) \right] \right).$$

Define an increasing family $W(0) \subset W(1) \subset \dots$ of free \mathbb{k} -modules inductively as follows: $W(0)$ is spanned by the z_α for which $dz_\alpha = 0$ and $W(m)$ is spanned by the z_α for which $dz_\alpha \in R \cdot W(m-1)$. Then $\{R \cdot W(m)\}$ will be a semifree filtration of (M, d) , provided that each z_α is in some $W(m)$. Write $(i, j) < (k, \ell)$ if $i < k$ or if $i = k$ and $j < \ell$. If $z_\alpha \in Z(k, \ell)$ then $dz_\alpha = \sum x_\beta z_\beta$ with $x_\beta \in R$ and $z_\beta \in Z(i, j)$, some $(i, j) < (k, \ell)$. We may assume by induction that each such z_β is in some $W(m_\beta)$. Put $m = \max_\beta m_\beta$. Then $dz_\alpha \in W(m)$ and so $z_\alpha \in W(m+1)$. \square

Let $\eta: (P, d) \longrightarrow (Q, d)$ be a morphism of (R, d) -modules, and for any third (R, d) -module, (M, d) , denote by

$$\text{Hom}_R(M, \eta): \text{Hom}_R(M, P) \longrightarrow \text{Hom}_R(M, Q)$$

the morphism of complexes defined by $\varphi \mapsto \eta \circ \varphi$.

Proposition 6.4 *Suppose (M, d) is semifree and η is a quasi-isomorphism*
Then

(i) $\text{Hom}_R(M, \eta)$ is a quasi-isomorphism.

(ii) Given a diagram of morphisms of (R, d) -modules,

$$\begin{array}{ccc} & (P, d) & \\ & \downarrow \simeq \eta & \\ & (Q, d) & \\ (M, d) \xrightarrow{\psi} & & \end{array} \quad (6.5)$$

there is a unique homotopy class of morphisms $\varphi : (M, d) \rightarrow (P, d)$ such that

$$\eta \circ \varphi \sim_R \psi.$$

(iii) A quasi-isomorphism between semifree (R, d) -modules is an equivalence.

proof: (i) As remarked in Lemma 3.2 it is sufficient to show that given $f \in \text{Hom}_R(M, P)$ and $g \in \text{Hom}_R(M, Q)$ satisfying $d(f) = 0$ and $\eta \circ f = d(g)$ we can find $f' \in \text{Hom}_R(M, P)$ and $g' \in \text{Hom}_R(M, Q)$ satisfying $d(f') = f$ and $d(g') = \eta \circ f' - g$. Let $r = \deg f$.

Choose a semifree filtration $\{M(k)\}$ of M , put $M(-1) = 0$ and, as in Remark 6.1 write $M(k) = M(k-1) \oplus (R \otimes Z(k))$ where $Z(k)$ is k -free and $d : Z(k) \rightarrow M(k-1)$. We construct f' and g' inductively by extending from $M(k-1)$ to $M(k)$.

For this let $\{z_\alpha\}$ be a basis of $Z(k)$, put $p_\alpha = f(z_\alpha) - (-1)^r f'(dz_\alpha)$ and put $q_\alpha = g(z_\alpha) - (-1)^r g'(dz_\alpha)$. By hypothesis the equations $d(f') = f$ and $d(g') = \eta \circ f' - g$ are satisfied in $M(k-1)$. It follows after a short calculation that $dp_\alpha = 0$ and $\eta(p_\alpha) = dq_\alpha$. Since η is a quasi-isomorphism there are (by Lemma 3.2) elements $p'_\alpha \in P$ and $q'_\alpha \in Q$ such that $dp'_\alpha = p_\alpha$ and $dq'_\alpha = \eta(p'_\alpha) - q_\alpha$. Now extend f' and g' to R -linear maps in $M(k)$ by putting $f'(z_\alpha) = p'_\alpha$ and $g'(z_\alpha) = q'_\alpha$.

(ii) As remarked near the start of this section, $H_0(\text{Hom}_R(-, -))$ is the set of homotopy classes of morphisms. Thus by (i), composition with η induces a bijection from homotopy classes of morphisms $(M, d) \rightarrow (P, d)$ to homotopy classes of morphisms $(M, d) \rightarrow (Q, d)$.

(iii) Since (Q, d) is semifree we can find a morphism $\xi : (Q, d) \rightarrow (P, d)$ such that $\eta\xi \sim_R id_Q$. In particular, $\eta\xi\eta \sim_R id_Q\eta = \eta id_P$. Since (P, d) is semifree it follows from the uniqueness in (ii) that $\xi\eta \sim_R id_P$. \square

Remark Notice that Proposition 6.4 (ii) is the analogue of the Whitehead lifting lemma 1.5. As in §1 we use this to prove an analogue of the Cellular models theorem 1.4.

Proposition 6.6

(i) Every (R, d) -module (Q, d) has a semifree resolution $m : (M, d) \xrightarrow{\simeq} (Q, d)$.

(ii) If $m' : (M', d) \xrightarrow{\cong} (Q, d)$ is a second semifree resolution then there is an equivalence of (R, d) -modules $\alpha : (M', d) \rightarrow (M, d)$ such that $m \circ \alpha \sim_R m'$.

proof: (i) Let $V(0)$ be a free graded \mathbb{k} -module whose basis is a system of generators of the \mathbb{k} -module of cocycles of Q . Set $M(0) = (R, d) \otimes (V(0), 0)$. The inclusion $V(0) \rightarrow Q$ defines a morphism $g(0) : (M(0), d) \rightarrow (Q, d)$. Clearly $H(g(0))$ is surjective. We now construct an increasing sequence of morphisms $g(k) : (M(k), d) \rightarrow (Q, d)$. If $g(k-1)$ is defined, let $V(k)$ be the free \mathbb{k} -module whose basis v_α in degree i is in one to one correspondence with cocycles w_α representing a system of generators of $\ker H_{i-1}(g(k-1))$. Set $M(k) = M(k-1) \oplus (R \otimes V(k))$, and put $dv_\alpha = w_\alpha$. Denote $g(k-1)$ simply by g . Since $g(w_\alpha)$ is a coboundary, $g(w_\alpha) = d(x_\alpha)$ we put $g(k)(v_\alpha) = x_\alpha$. Finally, set $M = \bigcup_k M(k)$.

(ii) Proposition 6.4 (ii) asserts the existence of a morphism $\alpha : (M', d) \rightarrow (M, d)$ such that $m \circ \alpha \sim_R m'$. Thus $H(m) \circ H(\alpha) = H(m')$ and so $H(\alpha)$ is the isomorphism $H(m') \circ H(m)^{-1}$. In other words, α is a quasi-isomorphism. Hence, by Proposition 6.4 (iii) it is an equivalence. \square

(b) Quasi-isomorphism theorems.

A basic property satisfied by semifree modules is 'preservation of quasi-isomorphism' under the operations Hom and \otimes . First we set some notation: suppose $f : M \rightarrow M'$ and $g : P' \rightarrow P$ are R -linear maps between left R -modules and define

$$\text{Hom}_R(f, g) : \text{Hom}_R(M', P') \rightarrow \text{Hom}_R(M, P) \text{ by } \xi \mapsto (-1)^{\deg \xi \deg f} g \circ \xi \circ f.$$

Then, if $h : Q \rightarrow Q'$ is an R -linear map between right R -modules, define

$$h \otimes_R f : Q \otimes_R M \rightarrow Q' \otimes_R M' \text{ by } q \otimes_R m \mapsto (-1)^{\deg f \deg q} h(q) \otimes_R f(m).$$

If f, g and h commute with the differentials then $\text{Hom}_R(f, g)$ and $h \otimes_R f$ are morphisms of complexes.

Proposition 6.7 *Suppose (M, d) and (M', d) are (R, d) -semifree.*

(i) *If f and g are quasi-isomorphisms then so is $\text{Hom}_R(f, g)$.*

(ii) *If f and h are quasi-isomorphisms then so is $h \otimes_R f$.*

proof: (i) Since (M, d) and (M', d) are semifree, Proposition 6.4 (iii) asserts that f is an equivalence. Thus there is an inverse equivalence $f' : (M', d) \rightarrow (M, d)$ and R -linear maps $\theta : M \rightarrow M$ and $\theta' : M' \rightarrow M'$ such that

$$f' \circ f - id_M = d\theta + \theta d \quad \text{and} \quad f \circ f' - id_{M'} = d\theta' + \theta' d. \quad (6.8)$$

Apply $\text{Hom}_R(-, id_{P'})$ to these formulae to conclude that $\text{Hom}_R(f, id_{P'})$ is an equivalence. Since (M, d) is semifree, $\text{Hom}_R(id_M, g)$ is just the quasi-isomorphism

$\text{Hom}_R(M, g)$ of Proposition 6.4 (i).

Thus $\text{Hom}_R(f, g) = \text{Hom}_R(\text{id}_M, g) \circ \text{Hom}_R(f, \text{id}_{P'})$ is a quasi-isomorphism.

(ii) Applying $\text{id}_Q \otimes_R -$ to the formulae (6.8) above we deduce that $\text{id}_{Q'} \otimes_R f$ is an equivalence. Since $h \otimes_R f = (\text{id}_{Q'} \otimes_R f) \circ (h \otimes_R \text{id}_M)$ it is sufficient to show that $h \otimes_R \text{id}_M$ is a quasi-isomorphism. Let $M(k)$ be a semifree filtration; it is enough to show that each $h \otimes_R \text{id}_{M(k)}$ is a quasi-isomorphism, and we do this by induction on k .

Indeed, since $M(k)/M(k-1) = (R, d) \otimes (Z(k), 0)$ with $Z(k)$ a \mathbb{k} -free graded module it is obvious that $h \otimes_R \text{id}_{M(k)/M(k-1)}$ is a quasi-isomorphism. Moreover, as R -modules $M(k) = M(k-1) \oplus (R \otimes Z(k))$ — cf. the Remark in §6(a). Thus the commutative diagram of complexes,

$$\begin{array}{ccccccc}
 0 & \longrightarrow & Q \otimes_R M(k-1) & \longrightarrow & Q \otimes_R M(k) & \longrightarrow & Q \otimes_R \frac{M(k)}{M(k-1)} \longrightarrow 0 \\
 & & \downarrow h \otimes_R - & & \downarrow h \otimes_R - & & \downarrow h \otimes_R - \\
 0 & \longrightarrow & Q' \otimes_R M(k-1) & \longrightarrow & Q' \otimes_R M(k) & \longrightarrow & Q' \otimes_R \frac{M(k)}{M(k-1)} \longrightarrow 0
 \end{array} \tag{6.9}$$

is row exact. Now the Five lemma 3.1, applied to the resulting map of long exact homology sequences, gives the inductive step. \square

Remark 1 In Proposition 6.7 (ii) the identical argument shows that $h \otimes_R f$ is a quasi-isomorphism if (Q, d) and (Q', d) are semifree and (M, d) and (M', d) are unrestricted.

As it turns out, a somewhat more general result will be required. For this, fix a dga morphism

$$\varphi : (R, d) \longrightarrow (S, d).$$

Thus any left (or right) (S, d) -module, (N, d) becomes an (R, d) -module via $x \cdot n = \varphi(x)n$, $x \in R$, $n \in N$. Now suppose given the following left and right modules over (R, d) and (S, d) and R -linear maps f, g and h of complexes:

- $f : (M, d) \longrightarrow (M', d)$; M is left over R and M' is left over S .
- $g : (P', d) \longrightarrow (P, d)$; P' is left over S and P is left over R .
- $h : (Q, d) \longrightarrow (Q', d)$; Q is right over R and Q' is right over S .

Define

$$\text{Hom}_\varphi(f, g) : \text{Hom}_S(M', P') \longrightarrow \text{Hom}_R(M, P) \text{ by } \xi \mapsto (-1)^{\deg \xi \deg f} g \circ \xi \circ f$$

and

$$h \otimes_\varphi f : Q \otimes_R M \longrightarrow Q' \otimes_S M' \text{ by } q \otimes_R m \mapsto h(q) \otimes_S f(m).$$

Theorem 6.10 Suppose (M, d) is (R, d) -semifree and (M', d) is (S, d) -semifree.

(i) If φ, f and g are quasi-isomorphisms, so is $\text{Hom}_\varphi(f, g)$.

(ii) If φ, h and f are quasi-isomorphisms, so is $h \otimes_\varphi f$.

proof: As observed in Lemma 6.2, $(S \otimes_R M, d)$ is (S, d) -semifree. Moreover, since (M, d) is (R, d) -semifree

$$\varphi \otimes_R id : (R \otimes_R M, d) \longrightarrow (S \otimes_R M, d)$$

is a quasi-isomorphism, by Proposition 6.7 (ii). On the other hand, f extends to the morphism of (S, d) -modules

$$f' : (S \otimes_R M, d) \longrightarrow (M', d), \quad f'(y \otimes_R m) = yf(m), \quad y \in S, m \in M.$$

Clearly $f = f' \circ (\varphi \otimes_R id)$ and so f' is also a quasi-isomorphism.

(i) Note that $\text{Hom}_S(S \otimes_R M, -) = \text{Hom}_R(M, -)$ and that $\text{Hom}_\varphi(f, g)$ is the composite of the morphisms

$$\text{Hom}_R(id_M, g) : \text{Hom}_R(M, P') \longrightarrow \text{Hom}_R(M, P)$$

and

$$\text{Hom}_S(f', id_{P'}) : \text{Hom}_S(M', P') \longrightarrow \text{Hom}_S(S \otimes_R M, P').$$

In view of our remarks above, Proposition 6.7 (i) implies that both these morphisms are quasi-isomorphisms.

(ii) Observe that $Q' \otimes_S (S \otimes_R M) = Q' \otimes_R M$ and that $h \otimes_\varphi f$ is the composite of

$$id_{Q'} \otimes_S f' : Q' \otimes_S (S \otimes_R M) \longrightarrow Q' \otimes_S M'$$

with

$$h \otimes_R id_M : Q \otimes_R M \longrightarrow Q' \otimes_R M.$$

Now apply Proposition 6.7 (ii). □

Remark 2 The argument in 6.10 (ii) shows that $h \otimes_\varphi f$ is also a quasi-isomorphism if (Q, d) and (Q', d) are semifree and (M, d) and (M', d) are unrestricted — cf. Remark 1, above.

Finally, we establish a partial converse to Theorem 6.10 for *chain algebras*. Recall that a chain algebra is a dga, (R, d) and that $R = R_{\geq 0}$. The surjection $R_0 \rightarrow H_0(R)$, $x \mapsto [x]$ may be regarded as a morphism

$$\varepsilon_R : (R, d) \longrightarrow (H_0(R), 0)$$

natural with respect to chain algebra morphisms.

Suppose given

- a chain algebra quasi-isomorphism $\varphi : (R, d) \longrightarrow (R', d)$.

- a right (R, d) -semifree module (N, d) and a right (R', d) -semifree module (N', d) , both concentrated in degrees ≥ 0 .
- a morphism $f : (N, d) \rightarrow (N', d)$ as above (i.e., $f(nx) = f(n)\varphi(x)$, $n \in N$, $x \in R$).

Then we may construct the morphism of chain complexes

$$f \otimes_{\varphi} H_0(\varphi) : (N, d) \otimes_R H_0(R) \rightarrow (N', d) \otimes_{R'} H_0(R'). \quad (6.11)$$

Theorem 6.12 *With the hypotheses above:*

f is a quasi-isomorphism $\iff f \otimes_{\varphi} H_0(\varphi)$ is a quasi-isomorphism.

Proof: We have only to prove \Leftarrow since the reverse implication is just Remark 2. Define a decreasing sequence of differential ideals

$$R \supset I^1 \supset J^1 \supset I^2 \supset \dots \supset I^n \supset J^n \supset \dots$$

setting

$$(I^n)_k = \begin{cases} 0, & k < n-1 \\ (\text{Im } d)_k, & k = n-1 \\ R_k, & k \geq n \end{cases} \quad \text{and} \quad (J^n)_k = \begin{cases} 0, & k \leq n-1 \\ (\text{ker } d)_k, & k = n \\ R_k, & k > n. \end{cases}$$

These constructions are clearly natural.

By inspection, $H(I^n/J^n) = 0$. Since (N, d) is semifree, $N \otimes_R \{0\} \xrightarrow{\cong} N \otimes_R J^n/I^n$. Thus

$$N \otimes_R I^n/J^n \xrightarrow{\cong} N' \otimes_{R'} (I')^n/(J')^n,$$

since both sides have zero homology.

Also by inspection,

$$(J^n/I^{n+1})_k = \begin{cases} H_n(R), & k = n \\ 0, & \text{otherwise.} \end{cases}$$

Thus we may write $N \otimes_R J^n/I^{n+1} = (N \otimes_R H_0(R)) \otimes_{H_0(R)} H_n(R)$. Now $N \otimes_R H_0(R) \rightarrow N' \otimes_{R'} H_0(R')$ is a quasi-isomorphism of semifree $H_0(R)$ -modules. Tensoring this with the isomorphism $H_n(R) \xrightarrow{\cong} H_n(R')$ produces a quasi-isomorphism (Theorem 6.10) and so

$$N \otimes_R J^n/I^{n+1} \xrightarrow{\cong} N' \otimes_{R'} (J')^n/(I')^{n+1}.$$

Now an obvious induction via the five lemma shows that

$$N \otimes_R R/I^n \xrightarrow{\cong} N' \otimes_{R'} R'/(I')^n, \quad n \geq 1.$$

But since $N = N_{\geq 0}$, the modules N and $N \otimes_R R/I^{n+3}$ coincide in degrees $\leq n+1$. Thus their homology coincides in degrees $\leq n$. It follows that $H(f)$ is an isomorphism. \square

Exercises

1. Let V' and V'' be two copies of the graded vector space V and $(R \otimes V, d)$ a semifree module over the cochain algebra (R, d) . Prove that there is a (R, d) -semifree module of the form $(R \otimes (V' \oplus V'' \oplus sV), D)$ such that

(i) the natural inclusions $i', i'' : (R \otimes V, d) \hookrightarrow (R \otimes (V' \oplus V'' \oplus sV), D)$ defined by $i'x = x', i''x = x''$ are quasi-isomorphisms,

(ii) $Dsv = 1 \otimes v' + 1 \otimes v'' + S(dv)$, $v \in V$ where $S : R \otimes V \rightarrow R \otimes sV$ denotes the unique extension of $v \mapsto sv$ to an R -linear map of degree $+1$.

Deduce that two morphisms of R -modules $f, g : (R \otimes V, d) \rightarrow (M, d)$ are homotopic if and only if there exists a morphism of R -modules $F : (R \otimes (V' \oplus V'' \oplus sV), D) \rightarrow (M, d)$ such that $F \circ i' = f$ and $F \circ i'' = g$.

2. Prove that the two morphisms of $(\mathbb{Q}[x], 0)$ -modules $f, g : \mathbb{Q}[x] \otimes (\mathbb{Q}a \oplus \mathbb{Q}b) \rightarrow \mathbb{Q}[x] \otimes \mathbb{Q}z$ defined by: $\deg x = 4$, $\deg a = 2$, $\deg b = 5 = \deg z$, $da = 0 = dz$, $db = xa$, $f(a) = g(a) = 0$, $f(b) = z$ and $g(b) = 0$, induce the same map in homology but are not homotopic.

3. Let k be a field and $(T(V), d)$ be a chain algebra over k . Construct a contractible semifree $(T(V), d)$ -module of the form $(T(V) \otimes (Ik \oplus sV), D)$ with $Dsv - v \otimes 1 \in TV \otimes sV$.

4. Assume that in diagram (6.5) the morphism η is onto. Prove that there is a unique morphism φ such that $\eta\varphi = \psi$.

5. Let $f, g : P \rightarrow M$ and $\varphi : M \rightarrow N$ be morphisms of R -modules. Prove that if P is semifree and φ is a quasi-isomorphism, then $f \simeq_R g$ if and only if $\varphi \circ f \simeq_R \varphi \circ g$.

6. Let M and N be chain complexes over $R = (R, 0)$ and assume that M and $H(M)$ are R -free modules. Prove that $H(M \otimes N) \cong H(M) \otimes H(N)$.

7. Let X be a finite CW complex. Prove that the cellular chain complex of X , C_*^X , is a semifree \mathbb{Z} -module and that for any space Y the quasi-isomorphism $C_*^X \xrightarrow{\cong} C_*(X)$ extends to a quasi-isomorphism $C_*^X \otimes C_*(Y) \xrightarrow{\cong} C_*(X) \otimes C_*(Y)$.

8. Let $\varepsilon : (R, d) \rightarrow Ik$ an augmented cochain algebra and (P, d) an (R, d) -semifree module. Consider the surjective cochain map $(P, d) \rightarrow (Ik \otimes_R P, \bar{d})$. If $R^0 = Ik$ and $\bar{d} = 0$ we say that P is a *minimal semifree module*. Prove that if $R^1 = 0$ then any (R, d) -module M , with the property that for some r_0 , $M_r = 0$, for all $r < r_0$, admits a minimal semifree resolution $P = (R \otimes V, d) \xrightarrow{\cong} M$ and that a quasi-isomorphism between two minimal semifree resolutions is an isomorphism.

7 Semifree cochain models of a fibration

As usual, we work over an arbitrary commutative ground ring, \mathbb{k} .

We simplify notation in this section by writing $C^*(-)$ instead of $C^*(-; \mathbb{k})$ and $H^*(-)$ instead of $H^*(-; \mathbb{k})$. Thus (cf. §5) a continuous map $f : X \rightarrow Y$ induces a morphism of cochain algebras $C^*(f) : C^*(X) \leftarrow C^*(Y)$, which makes $C^*(X)$ into a left (resp. right) $C^*(Y)$ -module via $a \cdot b = C^*(f)a \cup b$ (resp. $b \cdot a = b \cup C^*(f)a$). We shall also simplify notation by denoting the tensor product over $C^*(Y)$ of $C^*(Y)$ -linear maps by $\alpha \otimes \beta$ instead of $\alpha \otimes_{C^*(Y)} \beta$.

Let F be the fibre of a fibration $\pi : X \rightarrow Y$, as defined in §2. The purpose of this section is to show, under mild hypotheses, *how to compute the cohomology of F from the left $C^*(Y)$ -module, $C^*(X)$* . The answer is surprisingly simple: if $m_Y : (M_Y, d) \xrightarrow{\cong} C^*(X)$ is a $C^*(Y)$ -semifree resolution, then

$$H^*(F) \cong H(\mathbb{k} \otimes_{C^*(Y)} (M_Y, d))$$

as graded vector spaces. (This will be proved if \mathbb{k} is a field, Y is simply connected and one of $H_*(F; \mathbb{k})$ and $H_*(Y; \mathbb{k})$ has finite type.)

Thus for the rest of this section we fix the following:

- A fibration $\pi : X \rightarrow Y$ with simply connected base Y and fibre inclusion $j : F \rightarrow X$ at a basepoint $y_0 \in Y$.
 - A morphism of left $C^*(Y)$ -modules, $m_Y : (M_Y, d) \rightarrow C^*(X)$, in which $(M_Y, d) \cong (C^*(Y) \otimes W, d)$ is $C^*(Y)$ -semifree.
- (7.1)

To state the main theorem we also require the following conventions and constructions dealing with pullbacks. Observe that M_Y and $C^*(Y) \otimes_{C^*(Y)} M_Y$ are identified by the inverse isomorphisms $v \mapsto 1 \otimes v$ and $a \cdot v \mapsto a \otimes v$. Now a continuous map

$$\psi : Z \rightarrow Y$$

determines three constructions associated with (7.1):

- the pullback fibration $\pi_Z : X_Z = Z \times_Y X \rightarrow Z$.
- the $C^*(Z)$ -semifree module $C^*(Z) \otimes_{C^*(Y)} M_Y$.
- a morphism of left $C^*(Z)$ -modules, $m_Z : C^*(Z) \otimes_{C^*(Y)} M_Y \rightarrow C^*(X_Z)$.

(This is really an abuse of notation, since these constructions depend on ψ rather than on Z .)

The first two constructions are self evident. To construct m_Z consider the diagrams

$$\begin{array}{ccc} X_Z & \xrightarrow{\varphi} & X \\ \pi_Z \downarrow & & \downarrow \pi \\ Z & \xrightarrow{\psi} & Y \end{array} \quad \text{and} \quad \begin{array}{ccc} C^*(X_Z) & \xleftarrow{C^*(\varphi)} & C^*(X) \\ C^*(\pi_Z) \uparrow & & \uparrow C^*(\pi) \\ C^*(Z) & \xleftarrow{C^*(\psi)} & C^*(Y) \end{array} \quad (7.2)$$

in which the left diagram is just the pullback diagram of §2(a). Then $m_Z : a \otimes v \mapsto a \cdot C^*(\varphi)m_Y(v), a \in C^*(Z), v \in M_Y$, is the unique $C^*(Z)$ -module morphism making the following diagram commute:

$$\begin{array}{ccc}
 C^*(X_Z) & \xleftarrow{C^*(\varphi)} & C^*(X) \\
 m_Z \uparrow & & \uparrow m_Y \\
 C^*(Z) \otimes_{C^*(Y)} M_Y & \xleftarrow{C^*(\psi) \otimes id} & C^*(Y) \otimes_{C^*(Y)} M_Y,
 \end{array} \tag{7.3}$$

(Here as above we have identified $M_Y = C^*(Y) \otimes_{C^*(Y)} M_Y$).

When $Z = \{y_0\}$ the map φ in (7.2) is just the inclusion $j : F \rightarrow X$ of the fibre. Moreover $C^*(y_0) = \mathbb{k}$ and $C^*(\psi)$ is the augmentation $\varepsilon : C^*(Y) \rightarrow \mathbb{k}$ corresponding to y_0 . Thus $C^*(y_0) \otimes_{C^*(Y)} M_Y = \mathbb{k} \otimes_{C^*(Y)} M_Y = \mathbb{k} \otimes_{C^*(Y)} (C^*(Y) \otimes W, d) = (W, \bar{d})$, and diagram (7.3) reduces to

$$\begin{array}{ccc}
 C^*(F) & \xleftarrow{C^*(j)} & C^*(X) \\
 \bar{m}_Y \uparrow & & \uparrow m_Y \\
 (W, \bar{d}) & \xleftarrow{\varepsilon \otimes id} & (C^*(Y) \otimes W, d)
 \end{array} \tag{7.4}$$

Our main result in this section is

Theorem 7.5 *Suppose $\pi : X \rightarrow Y$ and $m_Y : M_Y \rightarrow C^*(X)$ are as described in (7.1). Assume \mathbb{k} is a field and that at least one of the graded \mathbb{k} -vector spaces $H^*(Y), H^*(F)$ has finite type. Then*

$$m_Y \text{ is a quasi-isomorphism} \Rightarrow \bar{m}_Y \text{ is a quasi-isomorphism} .$$

Remarks 1 At the end of this section we shall extend Theorem 7.5 to more general cochain algebra functors (Theorem 7.10).

2 The reverse implication in Theorem 7.5 is also true (cf. Exercise 1)

3 Theorem 7.5 is essentially due to J.C. Moore, and also follows easily from a theorem of E. Brown [31]. W. Dwyer [47] has considerably weakened the hypothesis of simple connectivity on Y .

We shall prove Theorem 7.5 using an inductive procedure involving relative cochains. First we set some further notation. If $i : A \rightarrow Y$ is the inclusion of a subspace we denote $C^*(Y, A; \mathbb{k})$ simply by $C^*(Y, A)$; it is the kernel of the surjection $C^*(i) : C^*(Y) \rightarrow C^*(A)$. In this case the pullback X_A is the subspace $\pi^{-1}(A)$ of X , and m_A and m_Y fit into the commutative row-exact diagram

$$\begin{array}{ccccccc}
 0 & \longrightarrow & C^*(X, X_A) & \xrightarrow{\alpha} & C^*(X) & \longrightarrow & C^*(X_A) \longrightarrow 0 \\
 & & \uparrow m_{Y,A} & & \uparrow m_Y & & \uparrow m_A \\
 0 & \longrightarrow & C^*(Y, A) \otimes_{C^*(Y)} M_Y & \xrightarrow{\beta \otimes id} & C^*(Y) \otimes_{C^*(Y)} M_Y & \xrightarrow{C^*(i) \otimes id} & C^*(A) \otimes_{C^*(Y)} M_Y \longrightarrow 0,
 \end{array}$$

where α and β are the obvious inclusions. Indeed the right square commutes by definition, and hence $m_Y \circ (\beta \otimes id)$ factors uniquely through α to define $m_{Y,A}$. The exactness of the lower row follows because M_Y is free as a module over the graded algebra $C^*(Y)$.

Next, suppose A contains y_0 and that $\psi : (Z, B, z_0) \rightarrow (Y, A, y_0)$ is a continuous map. In this case we have a pullback map $\varphi : (X_Z, X_B) \rightarrow (X, X_A)$. As above we may construct first $m_Z : M_Z = C^*(Z) \otimes_{C^*(Y)} M_Y \rightarrow C^*(X_Z)$ and then $m_{Z,B}$. It is immediate from the definitions that the following diagram commutes:

$$\begin{array}{ccc}
 C^*(X_Z, X_B) & \xleftarrow{C^*(\varphi)} & C^*(X, X_A) \\
 m_{Z,B} \uparrow & & \uparrow m_{Y,A} \\
 C^*(Z, B) \otimes_{C^*(Y)} M_Y & \xleftarrow{C^*(\psi) \otimes id} & C^*(Y, A) \otimes_{C^*(Y)} M_Y,
 \end{array} \tag{7.6}$$

where we have identified $C^*(Z, B) \otimes_{C^*(Z)} (C^*(Z) \otimes_{C^*(Y)} M_Y) = C^*(Z, B) \otimes_{C^*(Y)} M_Y$. Moreover the fibre of π_Z at z_0 is just $\{z_0\} \times F$ and φ restricts to the identification $\{z_0\} \times F = F$. Thus it is immediate from the definitions that

$$\bar{m}_Z = \bar{m}_Y : (W, \bar{d}) \rightarrow C^*(F). \tag{7.7}$$

Finally we introduce the notation of *k-regular* : a morphism θ of cochain complexes is *k-regular* if $H^i(\theta)$ is an isomorphism for $i \leq k$ and injective for $i = k + 1$.

Suppose now that we are in the situation of Theorem 7.5 and, further that:

- for some $A \subset Y$, (Y, A) is a relative CW complex.
- $y_0 \in A$ and all the attaching maps have the form $(S^{n-1}, *) \rightarrow (Y_{n-1}, y_0)$; i.e. they are based maps.
- all the cells of (Y, A) have dimension at least two.
- at least one of the graded vector spaces $H^*(Y, A)$, $H^*(F)$ has finite type.
- $W = \{W^i\}_{i \geq 0}$ and in $M_Y = (C^*(Y) \otimes W, d)$,

$$d : W^n \rightarrow C^*(Y) \otimes W^{<n}, \quad n \geq 0.$$

Note that the last condition exhibits M_Y as $C^*(Y)$ -semifree.

Proposition 7.8 *Under the hypotheses above,*

$$\bar{m}_Y \text{ is } k\text{-regular} \implies m_{Y,A} \text{ is } (k + 2)\text{-regular}.$$

proof: We begin by establishing the proposition in four special cases.

Case 1: $(Y, A) = (\bigvee_{\alpha \in T} D_\alpha^n, \bigvee_{\alpha \in T} S_\alpha^{n-1})$, some $n \geq 2$.

Let $C^*(Y, A) \otimes_{\mathbb{k}} C^*(X)$ denote the tensor product of these two cochain complexes (over \mathbb{k}) and let $C^*(Y, A) \otimes_{\mathbb{k}} M_Y$ denote the tensor product of the cochain complexes $C^*(Y, A)$ and M_Y . We have used the notation $- \otimes_{\mathbb{k}} -$ for emphasis. Define a commutative square of morphisms of cochain complexes.

$$\begin{array}{ccc} C^*(Y, A) \otimes_{\mathbb{k}} C^*(X) & \xrightarrow{\mu} & C^*(X, X_A) \\ \text{id} \otimes m_Y \uparrow & & \uparrow m_{Y,A} \\ C^*(Y, A) \otimes_{\mathbb{k}} M_Y & \xrightarrow{\nu} & C^*(Y, A) \otimes_{C^*(Y)} M_Y \end{array}$$

as follows: $\mu(a \otimes b) = C^*(\pi)a \cup b$, and ν is the canonical surjection $- \otimes_{\mathbb{k}} - \rightarrow - \otimes_{C^*(Y)} -$. By Proposition 3.3 we may identify $H(\text{id} \otimes m_Y) = \text{id} \otimes H(m_Y)$. Since $H(C^*(Y, A)) = H^*(Y, A)$ is concentrated in degrees $n \geq 2$ (cf. §4(e)) it suffices to prove that μ and ν are quasi-isomorphisms and that m_Y is \mathbb{k} -regular.

A homotopy $(Y, y_0) \times I \rightarrow (Y, y_0)$ from the identity to the constant map lifts to a homotopy $(X, F) \times I \xrightarrow{\Phi} (X, F)$ from the identity to a map $\rho: X \rightarrow F$. More precisely, Φ is a homotopy $\text{id} \sim j\rho$. The restriction of Φ to $F \times I$ is a homotopy $\text{id} \sim \rho j$; i.e. ρ is a homotopy inverse for j . Define $\theta = (\theta_X, \theta_A): (X, X_A) \rightarrow (Y, A) \times F$ by $\theta_X(x) = (\pi x, \rho x)$. By the long exact homotopy sequence θ_X and θ_A are weak homotopy equivalences, and so $C^*(\theta)$ is a quasi-isomorphism.

On the other hand, a commutative row-exact diagram

$$\begin{array}{ccccccc} 0 & \longrightarrow & C^*((Y, A) \times F) & \longrightarrow & C^*(Y \times F) & \longrightarrow & C^*(A \times F) \longrightarrow 0 \\ & & \uparrow \lambda_3 & & \uparrow \lambda_2 & & \uparrow \lambda_1 \\ 0 & \longrightarrow & C^*(Y, A) \otimes_{\mathbb{k}} C^*(F) & \longrightarrow & C^*(Y) \otimes_{\mathbb{k}} C^*(F) & \longrightarrow & C^*(A) \otimes_{\mathbb{k}} C^*(F) \longrightarrow 0 \end{array}$$

is defined by $\lambda_i(a \otimes b) = C^*(\pi^L)a \cup C^*(\pi^R)b$, π^L and π^R denoting the projection of $- \times F$ on the left and right factors. By hypothesis either $H^*(Y, A)$ or $H^*(F)$ has finite type. In the former case (Y, A) has finitely many cells and $H^*(A)$ is finite dimensional. Thus in either case Proposition 5.3 asserts that the λ_i are quasi-isomorphisms.

Now observe that $C^*(\theta) \circ \lambda_3 = \mu \circ (\text{id} \otimes C^*(\rho))$. Since ρ is a homotopy equivalence $C^*(\rho)$ is a quasi-isomorphism. Hence so is μ .

To see that ν is a quasi-isomorphism we observe that because Y is contractible, $\mathbb{k} \rightarrow C^*(Y)$ is a quasi-isomorphism. Since \mathbb{k} is a field M_Y is trivially \mathbb{k} -semifree as well as $C^*(Y)$ -semifree. Hence Theorem 6.10 (ii) asserts that $\nu: - \otimes_{\mathbb{k}} M_Y \rightarrow - \otimes_{C^*(Y)} M_Y$ is a quasi-isomorphism.

Finally, consider the commutative diagram

$$\begin{array}{ccc} C^*(X) & \xrightarrow{C^*(j)} & C^*(F) \\ m_Y \uparrow & & \uparrow \bar{m}_Y \\ C^*(Y) \otimes_{C^*(Y)} M_Y & \xrightarrow{\varepsilon \otimes \text{id}} & \mathbb{k} \otimes_{C^*(Y)} M_Y \end{array}$$

Here $C^*(j)$ is a quasi-isomorphism because j is a homotopy equivalence, while ε and $\varepsilon \otimes id$ are quasi-isomorphisms because Y is contractible and M_Y is semifree. Since \bar{m}_Y is k -regular (by hypothesis), m_Y is k -regular too.

Case 2: $Y = A \cup \bigcup_{\alpha} e_{\alpha}^n$.

Because cells are attached by based maps the characteristic map has the form $\psi : (\bigvee_{\alpha} D_{\alpha}^n, \bigvee_{\alpha} S_{\alpha}^{n-1}) \rightarrow (Y, A)$. Put $Z = \bigvee_{\alpha} D_{\alpha}^n$ and $B = \bigvee_{\alpha} S_{\alpha}^{n-1}$, and consider the pullback

$$\begin{array}{ccc} (X_Z, X_B) & \xrightarrow{\varphi} & (X, X_A) \\ \downarrow & & \downarrow \\ (Z, B) & \xrightarrow{\psi} & (Y, A) \end{array}$$

Let o_{α} be the centre of D_{α}^n and put $O = Z - \bigsqcup_{\alpha} \{o_{\alpha}\}$ and $U = Y - \bigsqcup_{\alpha} \{o_{\alpha}\}$. The inclusions $B \hookrightarrow O$ and $A \hookrightarrow U$ are then homotopy equivalences and so, as in §4(e), an excision argument shows that $C^*(\psi)$ is a quasi-isomorphism. Since M_Y is semifree, $C^*(\psi) \otimes id : C^*(Y, A) \otimes_{C^*(Y)} M_Y \rightarrow C^*(Z, B) \otimes_{C^*(Y)} M_Y$ is also a quasi-isomorphism. Moreover the inclusions $X_B \hookrightarrow X_O$ and $X_A \hookrightarrow X_U$ are weak homotopy equivalences so that, again by excision, $C^*(\varphi)$ is a quasi-isomorphism.

Consider diagram (7.6). The horizontal arrows are quasi-isomorphisms so we need only show $m_{Z,B}$ is $(k + 2)$ -regular. As remarked in (7.7) $\bar{m}_Z = \bar{m}_Y$. Since $H^*(Z, B) \cong H^*(Y, A)$ this conclusion now follows from Case 1.

Case 3: (Y, A) has only finitely many cells.

Let Y_n be the n -skeleton of (Y, A) , denote X_{Y_n} simply by X_n and put $m(n, s) = m_{Y_n, Y_s} : C^*(Y_n, Y_s) \otimes_{C^*(Y)} M_Y \rightarrow C^*(X_n, X_s)$. By Case 2, each $m(n + 1, n)$ is $(k + 2)$ -regular. Induction on n via the Five lemma 3.1 and the row exact diagram

$$\begin{array}{ccccccc} 0 & \longrightarrow & \bullet & \longrightarrow & \bullet & \longrightarrow & \bullet & \longrightarrow & 0 \\ & & \uparrow & & \uparrow & & \uparrow & & \\ & & m(n+1, n) & & m(n+1, 0) & & m(n, 0) & & \\ & & \uparrow & & \uparrow & & \uparrow & & \\ 0 & \longrightarrow & \bullet & \longrightarrow & \bullet & \longrightarrow & \bullet & \longrightarrow & 0 \end{array}$$

shows that each $m(n, 0)$ is $(k + 2)$ -regular. Since (Y, A) is finite $m_{Y,A} = m(n, 0)$ for some n . Hence $m_{Y,A}$ is $(k + 2)$ -regular.

Case 4: $H^s(Y, A) = 0, s \leq k + 3$.

Here we show $m_{Y,A}$ is $(k + 2)$ -regular by proving that

$$H^s(C^*(Y, A) \otimes_{C^*(Y)} M_Y) = 0, s \leq k + 3 \text{ and } H^s(C^*(X, X_A)) = 0, s \leq k + 2.$$

For this recall that $M_Y = (C^*(Y) \otimes W, d)$ with $W = \{W^i\}_{i \geq 0}$ and $d : W^i \rightarrow C^*(Y) \otimes W^{<i}$. This gives $C^*(Y, A) \otimes_{C^*(Y)} M_Y = (C^*(Y, A) \otimes W, d)$ with $d :$

$W^i \rightarrow C^*(Y, A) \otimes W^{<i}$. Since $H^s(C^*(Y, A)) = H^s(Y, A) = 0$, $s \leq k+3$, the exactness of

$$H(C^*(Y, A) \otimes W^{<i}) \rightarrow H(C^*(Y, A) \otimes W^{\leq i}) \rightarrow H(C^*(Y, A)) \otimes W^i$$

implies via induction on i that $H^s(C^*(Y, A) \otimes W^{\leq i}) = 0$, $s \leq k+3$, all i . Hence $H^s(C^*(Y, A) \otimes W) = 0$, $s \leq k+3$.

Next observe that a non-zero class α in $H^*(X, X_A)$ restricts to a non-zero class in $H^*(X_Z, X_A)$ for some finite subcomplex $(Z, A) \subset (Y, A)$. (Indeed (cf. §5) α is non-zero on some cycle z in $C_*(X, X_A)$ which, for compactness reasons, is necessarily in some $C_*(X_Z, X_A)$.) Thus to prove the second assertion it is sufficient to show that the restriction maps $H^s(C^*(X, X_A)) \rightarrow H^s(C^*(X_Z, X_A))$ are zero for $s \leq k+2$ and (Z, A) finite.

Fix Z . We first extend it to a larger finite subcomplex $(Z[1], A) \subset (Y, A)$ so that the inclusion $\eta : (Z, A) \rightarrow (Z[1], A)$ satisfies $H_s(\eta) = 0$, $s \leq k+2$. (This implies $H^s(\eta) = 0$, $s \leq k+2$). Indeed the Cellular chain models theorem 4.18 shows that $H_*(Z, A)$ has a finite basis. Let u_1, \dots, u_N be cycles representing the basis elements of degree $\leq k+2$. The hypothesis $H^{\leq k+2}(Y, A) = 0$ implies $H_{\leq k+2}(Y, A) = 0$; hence $u_\lambda = db_\lambda$ in $C_*(Y, A)$. By compactness $b_\lambda \in C_*(Z_\lambda, A)$ for some finite subcomplex $(Z_\lambda, A) \supset (Z, A)$. Put $Z[1] = \bigcup_{\lambda=1}^N Z_\lambda$.

Finally, iterate this construction to give an increasing sequence $(Z, A) \subset (Z[1], A) \subset \dots \subset (Z[\ell], A) \subset \dots$ of finite subcomplexes such that the restriction maps $H^s(Z[\ell], A) \rightarrow H^s(Z[\ell-1], A)$ are zero for $s \leq k+2$.

For any subcomplex $(T, A) \subset (Y, A)$ recall that

$$(C^*(T, A) \otimes W, d) = C^*(T, A) \otimes_{C^*(Y)} (C^*(Y) \otimes W, d).$$

In particular, suppose $\Phi \in C^{\geq m}(Z[1], A) \otimes W$ is a cocycle of degree $s \leq k+2$. We remark that $(C^*(\eta) \otimes id)\Phi$ is cohomologous to a cocycle in $C^{\geq m+1}(Z, A) \otimes W$. Indeed, writing $\Phi = \Phi_m + \Phi_{m+1} + \dots$ with $\Phi_i \in C^i(Z[1], A) \otimes W$, and recalling that $d : W^j \rightarrow C^*(-) \otimes W^{<j}$, we deduce from $d\Phi = 0$ that $(d \otimes id)\Phi_m = 0$. Thus $\Phi_m = \sum a_\alpha \otimes w_\alpha$ with $da_\alpha = 0$. Since W is concentrated in non-negative degrees $m \leq s \leq k+2$. Thus $H^s(\eta)[a_\alpha] = 0$ and $C^*(\eta)a_\alpha = db_\alpha$. Evidently $(C^*(\eta) \otimes id)\Phi - d(\sum b_\alpha \otimes w_\alpha) \in C^{\geq m+1}(Z, A) \otimes W$.

Put $(T, A) = (Z[k+3], A)$ and let $\xi : (Z, A) \rightarrow (T, A)$ be the inclusion. If $\Phi \in C^*(T, A) \otimes W$ is a cocycle of degree $s \leq k+2$, it follows now that $(C^*(\xi) \otimes id)\Phi$ is cohomologous to a cocycle in $C^{\geq k+2}(Z, A) \otimes W$. Since $s \leq k+2$ and $W = \{W^i\}_{i \geq 0}$, this cocycle is zero; i.e. $H^s(C^*(\xi) \otimes id) = 0$, $s \leq k+2$.

Consider the commutative diagram

$$\begin{array}{ccc} H^s(X_Z, X_A) & \longleftarrow & H^s(X_T, X_A) \\ \uparrow H^s(m_{Z,A}) & & \uparrow H^s(m_{T,A}) \\ H^s(C^*(Z, A) \otimes W) & \xleftarrow{H^s(C^*(\xi) \otimes id)} & H^s(C^*(T, A) \otimes W) \end{array}$$

The vertical arrows are isomorphisms (Case 3) for $s \leq k+2$. Thus $H^s(X_T, X_A) \rightarrow H^s(X_Z, X_A) = 0$, $s \leq k+2$, and so, a fortiori, is the composite $H^s(X, X_A) \rightarrow H^s(X_T, X_A) \rightarrow H^s(X_Z, X_A)$.

We now prove the proposition in general. Let (C_*, ∂) denote the cellular chain complex (§4(e)) for Y : C_n is free on a basis v_α corresponding to the n -cells $\{e_\alpha^n\}_{\alpha \in \mathcal{T}_n}$ of Y . Since \mathbb{k} is a field we may choose subsets $\mathcal{K}_n \subset \mathcal{J}_n \subset \mathcal{T}_n$ such that

$$C_n = (\ker \partial)_n \oplus \bigoplus_{\alpha \in \mathcal{K}_n} \mathbb{k}v_\alpha = (\text{Im } \partial)_n \oplus \bigoplus_{\alpha \in \mathcal{J}_n} \mathbb{k}v_\alpha.$$

Let Y_n be the n -skeleton of the relative CW complex (Y, A) , and define a sequence of subcomplexes $\cdots (S(n), A) \subset (T(n), A) \subset (S(n+1), A) \subset \cdots$ by

$$S(n) = Y_{n-1} \cup \left(\bigcup_{\alpha \in \mathcal{K}_n} e_\alpha^n \right) \quad \text{and} \quad T(n) = Y_{n-1} \cup \left(\bigcup_{\alpha \in \mathcal{J}_n} e_\alpha^n \right).$$

Using the Cellular chain models theorem 4.18 we see that

$$H^*(T(n), S(n)) = H^n(Y, A),$$

$$H^*(S(n+1), T(n)) = 0$$

and

$$H^i(Y, S(k+4)) = 0, \quad i \leq k+3.$$

By Cases 2 and 4, the morphisms $m_{T(n), S(n)}$, $m_{S(n+1), T(n)}$ and $m_{Y, S(k+4)}$ are all $(k+2)$ -regular. Since $S(1) = A$ (because (Y, A) has no 1-cells or 0-cells) the same argument as in Case 3 shows $m_{Y, A}$ is $(k+2)$ -regular. \square

proof of Theorem 7.5: Choose a weak homotopy equivalence $\psi : (Z, z_0) \rightarrow (Y, y_0)$ from a CW complex Z (Theorem 1.4). The construction in the proof of 1.4 shows that Z may be chosen with a single 0-cell, z_0 , no 1-cells and with all cells attached by based maps. Let $\varphi : X_Z \rightarrow X$ be the pullback map. It, too, must be a weak homotopy equivalence. Thus in the commutative diagram (cf. (7.3))

$$\begin{array}{ccc} C^*(X_Z) & \xleftarrow{C^*(\varphi)} & C^*(X) \\ m_Z \uparrow & & \uparrow m_Y \\ C^*(Z) \otimes_{C^*(Y)} M_Y & \xleftarrow{C^*(\psi) \otimes id} & C^*(Y) \otimes_{C^*(Y)} M_Y, \end{array}$$

both m_Y and the horizontal arrows are quasi-isomorphisms; hence m_Z is a quasi-isomorphism too. Since $H^*(Z) \cong H^*(Y)$, the pullback fibration satisfies the hypotheses of 7.5. Thus since $\bar{m}_Z = \bar{m}_Y$ (cf. 7.7) it is sufficient to prove the theorem for $m_Z : C^*(Z) \otimes_{C^*(Y)} M_Y \rightarrow C^*(X_Z)$ and \bar{m}_Z ; i.e. we may assume Y is a CW complex as described above.

Put $H = H^*(F; \mathbb{k})$ and let $\theta : (H, 0) \rightarrow C^*(F)$ be a (not necessarily multiplicative) morphism of cochain complexes satisfying $H(\theta) = id$. We construct now a $C^*(Y)$ -semifree module $(C^*(Y) \otimes H, d)$ and a quasi-isomorphism

$\mu_Y : (C^*(Y) \otimes H, d) \rightarrow C^*(X)$ of $C^*(Y)$ -modules such that

$$d : H^n \rightarrow C^*(Y) \otimes H^{<n}, \text{ all } n \quad \text{and} \quad \bar{\mu}_Y = \theta : (H, 0) \rightarrow C^*(F).$$

Note that the first condition will imply that $(C^*(Y) \otimes H, d)$ is semifree.

Suppose d and μ_Y are constructed in $C^*(Y) \otimes H^{<n}$. Consider the row-exact commutative diagram

$$\begin{array}{ccccccccc} 0 & \longrightarrow & C^*(X, F) & \longrightarrow & C^*(X) & \longrightarrow & C^*(F) & \longrightarrow & 0 \\ & & \uparrow \mu_{Y, y_0} & & \uparrow \mu_Y & & \uparrow \bar{\mu}_Y & & \\ 0 & \longrightarrow & (C^*(Y, y_0) \otimes H^{<n}, d) & \longrightarrow & (C^*(Y) \otimes H^{<n}, d) & \longrightarrow & (H^{<n}, 0) & \longrightarrow & 0. \end{array}$$

Since $\bar{\mu}_Y = \theta$ is $(n - 1)$ -regular by construction, Proposition 7.8 asserts that μ_{Y, y_0} is $(n + 1)$ -regular. Let $\{\gamma_k\}$ be a basis of H^n and lift the cocycles $\theta\gamma_k$ to elements $\chi_k \in C^n(X)$. Then $d\chi_k$ is a cocycle in $C^{n+1}(X, F)$ and so $d\chi_k = \mu_{Y, y_0}(u_k) + dv_k$ for some cocycle $u_k \in C(Y, y_0) \otimes H^{<n}$ and some $v_k \in C^n(X, F)$. Extend d and μ_Y by setting $d\gamma_k = u_k$ and $\mu_Y(\gamma_k) = \chi_k - v_k$. In this way $(C^*(Y) \otimes H, d) \xrightarrow{\mu_Y} C^*(X)$ is constructed.

Since $\bar{\mu}_Y$ is the quasi-isomorphism θ , Proposition 7.8 asserts that μ_{Y, y_0} is a quasi-isomorphism too. Hence, by the five lemma, so is μ_Y .

Finally, consider the diagram

$$\begin{array}{ccc} & (C^*(Y) \otimes H, d) & \\ & \nearrow \dots & \downarrow \simeq \mu_Y \\ M_Y & \xrightarrow{\simeq m_Y} & C^*(X) \end{array}$$

Since M_Y is semifree we may (Proposition 6.4 (ii)) find a $C^*(Y)$ -module morphism $\nu : M_Y \rightarrow (C^*(Y) \otimes H, d)$ and a $C^*(Y)$ -linear map $h : M_Y \rightarrow C^*(X)$ such that

$$\mu_Y \nu - m_Y = dh + hd.$$

In particular $H(\mu_Y) \circ H(\nu) = H(m_Y)$ and ν is a quasi-isomorphism.

It follows by Proposition 6.7 (ii) that ν factors to give a quasi-isomorphism $\bar{\nu} : \mathbb{k} \otimes_{C^*(Y)} M_Y \rightarrow \mathbb{k} \otimes_{C^*(Y)} (C^*(Y) \otimes H, d)$. Similarly, since h is $C^*(Y)$ -linear, a linear map $\bar{h} : \mathbb{k} \otimes_{C^*(Y)} M_Y \rightarrow C^*(F)$ is defined by the commutative diagram

$$\begin{array}{ccc} C^*(F) & \xleftarrow{C^*(j)} & C^*(X) \\ \bar{h} \uparrow & & \uparrow h \\ \mathbb{k} \otimes_{C^*(Y)} M_Y & \longleftarrow & M_Y. \end{array}$$

It is immediate from this construction that $\bar{\mu}_Y \bar{\nu} - \bar{m}_Y = d\bar{h} + \bar{h}d$. Hence $H(\bar{m}_Y) = H(\bar{\mu}_Y) \circ H(\bar{\nu})$ is an isomorphism. \square

We finish this section by extending Theorem 7.5 to a somewhat more general setting. We have worked till now with the square

$$\mathcal{D}_C : \begin{array}{ccc} C^*(F) & \xrightarrow{C^*(j)} & C^*(X) \\ \uparrow & & \uparrow C^*(\pi) \\ \mathbb{k} & \longleftarrow & C^*(Y). \end{array}$$

Now suppose more generally that

$$\mathcal{D} : \begin{array}{ccc} A & \xleftarrow{\varrho} & E \\ \uparrow & & \uparrow \lambda \\ \mathbb{k} & \xleftarrow{\varepsilon} & B \end{array}$$

is any commutative square of cochain algebra morphisms. A *quasi-isomorphism* $\mathcal{D} \xrightarrow{\cong} \mathcal{D}(1)$ from \mathcal{D} to a second such square $\mathcal{D}(1)$ consists of cochain algebra quasi-isomorphisms

$$\beta : B \xrightarrow{\cong} B(1), \quad \gamma : E \xrightarrow{\cong} E(1) \quad \text{and} \quad \alpha : A \xrightarrow{\cong} A(1)$$

that define a commutative cube connecting \mathcal{D} to $\mathcal{D}(1)$. In particular, we shall say that the squares \mathcal{D}_C and \mathcal{D} above are *weakly equivalent* if they are connected by a finite chain of quasi-isomorphisms of the form

$$\mathcal{D} \xrightarrow{\cong} \mathcal{D}(1) \xleftarrow{\cong} \mathcal{D}(2) \xrightarrow{\cong} \dots \xleftarrow{\cong} \mathcal{D}_C .$$

Now consider the square \mathcal{D} . Left multiplication by $\lambda(b)$, $b \in B$ makes E into a left B -module for which (Proposition 6.6) there will be a semifree resolution $m_B : M_B \xrightarrow{\cong} E$. From this we may, as in (7.4), define a morphism \bar{m}_B of complexes by the commutative diagram

$$\begin{array}{ccc} A & \xleftarrow{\varrho} & E \\ \bar{m}_B \uparrow & & \simeq \uparrow m_B \\ \mathbb{k} \otimes_B M_B & \xleftarrow{\varepsilon \otimes id} & B \otimes_B M_B . \end{array} \tag{7.9}$$

Theorem 7.10 *Suppose \mathbb{k} is a field, $\pi : X \rightarrow Y$ is a fibration with Y simply connected and that one of the graded \mathbb{k} -vector spaces $H^*(Y)$, $H^*(F)$ has finite type. If \mathcal{D} is a square weakly equivalent to \mathcal{D}_C and if $m_B : M_B \xrightarrow{\cong} E$ is a B -semifree resolution then*

$$\bar{m}_B : \mathbb{k} \otimes_B M_B \rightarrow A$$

is a quasi-isomorphism.

proof: Suppose given a quasi-isomorphism $\mathcal{D} \rightarrow \mathcal{D}(1)$ as above. Then we have the commutative diagram

$$\begin{array}{ccc} E & \xrightarrow[\cong]{\gamma} & E(1) \\ m_B \uparrow \cong & & \uparrow m \\ B \otimes_B M_B & \xrightarrow[\beta \otimes id]{\cong} & B(1) \otimes_B M_B \end{array}$$

which identifies m as a quasi-isomorphism. From this we deduce that $\bar{m} = \alpha \circ \bar{m}_B : \mathcal{K} \otimes_B M_B \rightarrow A(1)$.

On the other hand, suppose $m(1) : M(1) \xrightarrow{\cong} E(1)$ is any $B(1)$ -semifree resolution. Then, exactly as in the last part of the proof of Theorem 7.5, we can find a quasi-isomorphism $\nu : M(1) \rightarrow B(1) \otimes_B M_B$ of $B(1)$ modules such that $m \circ \nu$ is $B(1)$ -homotopic to $m(1)$. Since ν is a quasi-isomorphism so is $\bar{\nu} : \mathcal{K} \otimes_{B(1)} M(1) \rightarrow \mathcal{K} \otimes_B M_B$. Moreover, exactly as at the end of the proof of Theorem 7.5, $H(\bar{m}) \circ H(\bar{\nu}) = H(\overline{m(1)})$. Altogether we conclude that

$$\begin{aligned} \bar{m}_B \text{ is a quasi-isomorphism} &\iff \bar{m} \text{ is a quasi-isomorphism} \\ &\iff \overline{m(1)} \text{ is a quasi-isomorphism.} \end{aligned}$$

Consider the chain connecting \mathcal{D} to \mathcal{D}_C , and recall that the semifree model for \mathcal{D}_C is just $m_Y : M_Y \rightarrow C^*(X)$. Thus the argument above, repeated along the chain, shows that \bar{m}_B is a quasi-isomorphism if and only if \bar{m}_Y is. But \bar{m}_Y is a quasi-isomorphism by Theorem 7.5. \square

Exercises

1. Prove the converse of Theorem 7.5.

2. Let $\pi : X \rightarrow Y$ be a fibration with simply connected base. Assume \mathcal{K} is a field and that $H^*(F; \mathcal{K})$ has finite type. Let $(R, d) \rightarrow C^*(Y, \mathcal{K})$ be a quasi-isomorphism of cochain algebras. Prove that the fibration π admits a minimal semifree resolution (§ 6-exercise 7) of the form $(R \otimes H, d)$ with $H = H^*(F; \mathcal{K})$ and $d(H^k) \subset R \otimes H^{<k}$. Write, for any $\Phi \in H$, $d\Phi = d^1\Phi + \dots + d^n\Phi + \dots$ with $d^n\Phi \in (R^n \otimes H)$. Prove that this sum is finite and if $d^1\Phi = \dots = d^r\Phi = 0$ that $d^{r+1}\Phi$ is a cocycle in $(R \otimes H, d)$. A class Φ is *transgressive* if there exists n such that $d^1\Phi = \dots = d^n\Phi = 0$ that $d^{n+1}\Phi \neq 0$. Prove that this definition does not depend on the choice of the minimal resolution and that the set T of transgressive classes is a vector space, so that $\Phi \mapsto [d^{n+1}\Phi]$ defines a linear map $T^n \xrightarrow{\tau} H^{n+1}(Y)$. A fibration is *totally transgressive* if $H^*(F, \mathcal{K}) = T$. Characterize the minimal resolutions of totally transgressive fibrations.

3. In exercise 2, assume $F = S^n$. Prove that the fibration admits a minimal semifree resolution of the form $(R \otimes \wedge x / (x^2), d)$ with $dx \in R^{n+1}$. The cohomology class $\chi = [dx] \in H^{n+1}(X; \mathcal{K})$ is called *the Euler class* of the fibration. If n is odd, prove that we have a short exact sequence $0 \rightarrow (R, d) \rightarrow (R \otimes \wedge x, d) \rightarrow (R \otimes$

$Ikx, d \otimes id) \rightarrow 0$ with associated long exact sequence (*Gysin exact sequence*)
 $\dots \rightarrow H^{i+n}(X) \rightarrow H^i(Y) \xrightarrow{\times \chi} H^{i+n+1}(Y) \xrightarrow{H(\pi)} H^{i+n+1}(X) \rightarrow \dots$

4. In exercise 2, assume $Y = S^n$. Prove that this fibration admits a resolution of the form $(\wedge b/(b^2), 0) \rightarrow (\wedge b/(b^2) \otimes H, d) \xrightarrow{\rho} (H, 0)$ with $d\Phi = b \otimes \theta(\Phi)$, $\Phi \in H$, $\deg b = n$. Deduce that there is a short exact sequence $0 \rightarrow (Ikb \otimes H, 0) \rightarrow (\wedge b/(b^2) \otimes H, 0) \rightarrow (H, 0) \rightarrow 0$ with associated long exact sequence (*Wang exact sequence*) $\dots \rightarrow H^i(F) \rightarrow H^{i+n}(X) \xrightarrow{H\rho} H^{i+n}(F) \rightarrow H^{i+1}(F) \rightarrow \dots$

5. Prove that the homotopy fibre of the canonical projection $S^2 \vee S^1 \rightarrow S^1$ is an infinite bouquet of 2 dimensional spheres. Does the conclusion of theorem 7.5 hold?

6. Let $F \xrightarrow{j} X \xrightarrow{p} Y$ be a fibration as in exercise 2. Assuming that $\pi_i(p)$ is an isomorphism for $i \leq n$, deduce that $H_i(p)$ is an isomorphism for $i \leq n$.

7. Let (X, A) be a pointed pair. Construct, for each $n \geq 1$, a natural map $h_{(X,A)} : \pi_n(X, A, a_0) \rightarrow H_n(X, A; \mathbb{Z})$ such that $(h_A, h_X, h_{(X,A)})$ maps the homotopy long exact sequence into the homology long exact sequence of the pair (X, A) . Deduce *Whitehead's theorem* from exercise 6: Let $f : X \rightarrow Y$ be a continuous map with X and Y path connected. If $(\pi_k f) \otimes Ik$ is an isomorphism for $k < n$ and is surjective for $k = n$ then $H_k(f; Ik)$ is an isomorphism for $k < n$ and is surjective for $k = n$.

8 Semifree chain models of a G -fibration

As usual, we work over an arbitrary commutative ground ring, \mathbb{k} . For simplicity, we denote $C_*(-; \mathbb{k})$ simply by $C_*(-)$ and $H_*(-; \mathbb{k})$ simply by $H_*(-)$.

In §2(b) we defined the action of a topological monoid, G and the notion of a G -fibration. Here we show how multiplication in G makes $C_*(G)$ into a chain algebra, and how an action of G in a space P makes $C_*(P)$ into a $C_*(G)$ -module. Then, in the case of G -fibrations $P \xrightarrow{\pi} X$ we show (Theorem 8.3) that: if $(M, d) \xrightarrow{\cong} C_*(P)$ is a $C_*(G)$ -semifree resolution then there is an induced quasi-isomorphism $(M, d) \otimes_{C_*(G)} \mathbb{k} \xrightarrow{\cong} C_*(X)$.

Notice that this is the exact analogue of Theorem 7.5.

Using Theorem 8.3 we then give a geometric application of the isomorphism theorems of §6. Finally we apply this to provide an elementary proof of the Whitehead-Serre theorem (Theorem 8.6):

If \mathbb{k} is a subring of \mathbb{Q} and if $\varphi : X \rightarrow Y$ is a continuous map between simply connected spaces then $\pi_(\varphi) \otimes_{\mathbb{Z}} \mathbb{k}$ is an isomorphism if and only if $H_*(\varphi; \mathbb{k})$ is an isomorphism.*

This section is divided into the following topics:

- (a) The chain algebra of a topological monoid.
- (b) Semifree chain models.
- (c) The quasi-isomorphism theorem.
- (d) The Whitehead-Serre theorem.

(a) The chain algebra of a topological monoid.

Suppose G is a topological monoid. To make $C_*(G)$ into a chain algebra we use the Eilenberg-Zilber chain equivalences introduced in §4(b). If μ is the multiplication in G then we assign to $C_*(G)$ the multiplication

$$C_*(G) \otimes C_*(G) \xrightarrow{EZ} C_*(G \times G) \xrightarrow{C_*(\mu)} C_*(G).$$

It is associative because EZ and μ are. The identity $1 \in C_*(G)$ is the 0-simplex at the identity $e \in G$. By $C_*(G)$ -module we shall mean a module (M, d) over the chain algebra, $C_*(G)$.

The constant map $G \rightarrow \text{pt}$ may be regarded as a map of monoids, and so the augmentation

$$\varepsilon : C_*(G; \mathbb{k}) \rightarrow \mathbb{k} \tag{8.1}$$

is a dga morphism. In particular it makes \mathbb{k} into a $C_*(G; \mathbb{k})$ -module.

In the same way a right action $\mu_p : P \times G \rightarrow P$ induces the morphism $C_*(\mu_p) \circ EZ : C_*(P; \mathbb{k}) \otimes C_*(G; \mathbb{k}) \rightarrow C_*(P; \mathbb{k})$, which makes $C_*(P; \mathbb{k})$ into

a right $C_*(G; \mathbb{k})$ -module. In the case of a G -Serre fibration $p : P \rightarrow X$ the commutative diagram

$$\begin{array}{ccc} P \times G & \xrightarrow{\mu_p} & P \\ p \times \text{const} \downarrow & & \downarrow p \\ X \times \{\text{pt}\} & \xrightarrow{=} & X \end{array}$$

translates (cf. (4.5)) to the algebraic formula

$$C_*(p)(u \cdot a) = \varepsilon(a)C_*(p)u, \quad u \in C_*(P), \quad a \in C_*(G).$$

Thus a morphism, $m : M \rightarrow C_*(P)$, of right $C_*(G)$ -modules induces a unique commutative diagram

$$\begin{array}{ccc} M & \xrightarrow{m} & C_*(P) \\ \zeta \downarrow & & \downarrow C_*(p), \\ M \otimes_{C_*(G)} \mathbb{k} & \xrightarrow{n} & C_*(X) \end{array} \quad \zeta x = x \otimes_{C_*(G)} 1, \quad x \in M. \quad (8.2)$$

of chain complexes. When $m = id : C_*(P) \rightarrow C_*(P)$ we write $n = \overline{C_*(p)} : C_*(P) \otimes_{C_*(G)} \mathbb{k} \rightarrow C_*(X)$. Otherwise we will usually denote n by $\bar{m} : M \otimes_{C_*(G)} \mathbb{k} \rightarrow C_*(X)$.

(b) Semifree chain models.

In general, $\overline{C_*(p)}$ is not a quasi-isomorphism. However, if we replace $C_*(P)$ by a $C_*(G)$ -semifree resolution, we have

Theorem 8.3 *Suppose $P \xrightarrow{p} X$ is a G -Serre fibration and $m : M \xrightarrow{\cong} C_*(P)$ is a $C_*(G)$ -semifree resolution. Then*

$$\bar{m} : M \otimes_{C_*(G)} \mathbb{k} \rightarrow C_*(X)$$

is a quasi-isomorphism.

The main step in the proof of Theorem 8.3 is the construction of a certain ‘geometric’ $C_*(G)$ -semifree resolution of $C_*(P)$ when X is a CW complex. This is a simple generalization of the cellular chain models of §4(e). We first carry out this construction, and then prove Theorem 8.3.

Thus we suppose X is a CW complex with n -skeleton X_n . Recall from §4(e) that a cellular chain model for X is a quasi-isomorphism $q : (C, \partial) \xrightarrow{\cong} C_*(X)$ that restricts to quasi-isomorphisms $q_n : (C_{\leq n}, \partial) \xrightarrow{\cong} C_*(X_n)$, $n \geq 0$. In particular q_n induces an isomorphism $C_n \xrightarrow{\cong} H_n(X_n, X_{n-1})$, and this identifies C_n as a free \mathbb{k} -module on a basis $\{c_\alpha\}$ corresponding to the n -cells of X . Moreover ∂ is identified with a certain connecting homomorphism.

Denote by $p : P_n \rightarrow X_n$ the G -fibration obtained by restricting p to $P_n = p^{-1}(X_n)$.

Definition A *cellular chain model* for the G -fibration $p : P \rightarrow X$ is a quasi-isomorphism of right $C_*(G)$ -modules of the form

$$m : (C \otimes C_*(G), d) \xrightarrow{\cong} C_*(P),$$

restricting to quasi isomorphisms $m(n) : (C_{\leq n} \otimes C_*(G), d) \xrightarrow{\cong} C_*(P_n)$, and such that

$$\bar{m} : (C, \bar{d}) = (C \otimes C_*(G), d) \otimes_{C_*(G)} k \rightarrow C_*(X)$$

is a cellular chain model for X .

Remark Since $C_*(G)$ is concentrated in non-negative degrees necessarily $d : C_n \otimes 1 \rightarrow C_{<n} \otimes C_*(G)$. This exhibits $m : (C \otimes C_*(G), d) \rightarrow C_*(P)$ as a $C_*(G)$ -semifree resolution.

Proposition 8.4 *Every G -Serre fibration whose base is a CW complex has a cellular chain model.*

proof: Denote the fibration by $p : P \rightarrow X$ and adopt the notation above, so that the n -cells of X form a basis, c_α , of $H_n(X_n, X_{n-1})$. We show first that $H_*(P_n, P_{n-1})$ is a free $H_*(G)$ -module on a basis $a_\alpha \in H_n(P_n, P_{n-1})$ satisfying $H_*(p)a_\alpha = c_\alpha$. Write $X_n = X_{n-1} \cup \left(\bigcup_\alpha e_\alpha^n \right)$ and let $f : \left(\bigsqcup_\alpha D_\alpha^n, \bigsqcup_\alpha S_\alpha^{n-1} \right) \rightarrow (X_n, X_{n-1})$ be the characteristic map. Write $(D, S) = \left(\bigsqcup_\alpha D_\alpha^n, \bigsqcup_\alpha S_\alpha^{n-1} \right)$ and use f to pull the fibration $P \rightarrow X$ back to the G -fibration

$$P_D = D \times_X P \xrightarrow{p_D} D, \quad (y, z) \cdot g = (y, zg), \quad (y, z) \in P_D, \quad g \in G.$$

Let P_S be the restriction of P_D to S , and let $\varphi : (P_D, P_S) \rightarrow (P_n, P_{n-1})$ be the pullback map. We first observe that $H_*(f)$ and $H_*(\varphi)$ are isomorphisms.

Indeed, if o_α is the centre of D_α^n put $O = D - \bigsqcup_\alpha \{o_\alpha\}$, $U = X_n - \bigsqcup_\alpha \{o_\alpha\}$, $P_O = p_D^{-1}(O)$ and $P_U = p^{-1}(U)$. The inclusions $S \hookrightarrow O$ and $X_{n-1} \hookrightarrow U$ are homotopy equivalences, and hence $P_S \rightarrow P_O$ and $P_{n-1} \hookrightarrow P_U$ are weak homotopy equivalences (Proposition 2.3). Exactly as in §4(e) it follows by excision that $H_*(f)$ and $H_*(\varphi)$ are isomorphisms.

Choose a contracting homotopy $D \times I \rightarrow D$ from the map $\bigsqcup D_\alpha^n \rightarrow \bigsqcup \{o_\alpha^n\}$ to the identity. Choose points $z_\alpha \in p_D^{-1}(o_\alpha)$ and lift this homotopy to a map $H : D \times I \rightarrow P_D$, starting at the map $\bigsqcup D_\alpha^n \rightarrow \bigsqcup \{z_\alpha^n\}$. Denote $H(-, 1)$ by $\sigma : D \rightarrow P_D$. Then $p_D \circ \sigma = id$. Let $D \times G \rightarrow D$ be the trivial G -fibration (with action $(x, g) \cdot g_1 = (x, gg_1)$) and define

$$\begin{array}{ccc} (D, S) \times G & \xrightarrow{\psi} & (P_D, P_S) \\ & \searrow & \swarrow p_D \\ & (D, S) & \end{array}$$

by $\psi(x, g) = \sigma(x) \cdot g$. By the very definition of G -Serre fibrations ψ restricts to weak homotopy equivalences in the fibres. Hence (Proposition 2.3) ψ restricts to a weak homotopy equivalences $D \times G \rightarrow P_D$ and $S \times G \rightarrow P_S$. It follows that $H_*(\psi)$ is an isomorphism.

Because $H_*(D, S) = H_n(D, S)$ is a free module (on the n -cells of X), there is a chain equivalence $H_n(D, S) \xrightarrow{\cong} C_*(D, S)$. Thus the composite

$$\begin{aligned} H_n(D, S) \otimes C_*(G) &\xrightarrow{\cong} C_*(D, S) \otimes C_*(G) \\ &\xrightarrow[EZ]{\cong} C_*((D, S) \times G) \\ &\xrightarrow[C_*(\psi)]{\cong} C_*(P_D, P_S) \\ &\xrightarrow[C_*(\varphi)]{\cong} C_*(P_n, P_{n-1}) \end{aligned}$$

defines an isomorphism $\lambda(n) : H_n(D, S) \otimes H_*(G) \xrightarrow{\cong} H_*(P_n, P_{n-1})$. The associativity of the Eilenberg-Zilber map implies that EZ above is a morphism of $C_*(G)$ -modules. Hence $\lambda(n)$ is an isomorphism of $H_*(G)$ modules.

Let $a_\alpha \in H_n(P_n, P_{n-1})$ be the image of $\lambda(n)(c_\alpha \otimes 1)$. Then $H_n(P_n, P_{n-1})$ is a free right $H_*(G)$ -module with basis $\{a_\alpha\}$, and $H_*(p)a_\alpha = c_\alpha$.

We now construct the semifree resolution $m : (C \otimes C_*(G), d) \rightarrow C_*(P)$ by an inductive process. Assume the quasi-isomorphism $m(n-1) : (C_{\leq n-1} \otimes C_*(G), d) \xrightarrow{\cong} C_*(P_{n-1})$ is defined. Let $b_\alpha \in C_n(P_n)$ be an element that projects to a cycle $z_\alpha \in C_n(P_n, P_{n-1})$ representing a_α . Then db_α is a cycle in $C_*(P_{n-1})$. Choose a cycle $u_\alpha \in C_{\leq n-1} \otimes C_*(G)$ and an element $w_\alpha \in C_n(P_{n-1})$ so that $m(n-1)(u_\alpha) = db_\alpha + dw_\alpha$. (Recall $H(m(n-1))$ is an isomorphism.) Extend d and $m(n-1)$ to $C_{\leq n} \otimes C_*(G)$ by setting $d(c_\alpha \otimes 1) = u_\alpha$ and $m(n)(c_\alpha \otimes 1) = b_\alpha + w_\alpha$. The map $C_{\leq n}/C_{< n} \otimes C_*(G) \rightarrow C_*(P_n, P_{n-1})$ induced from $m(n)$

produces, in homology, the morphism $\left(\bigoplus_\alpha \mathbb{k}c_\alpha\right) \otimes H_*(G) \rightarrow H_*(P_n, P_{n-1})$ of $H_*(G)$ -modules given by $c_\alpha \mapsto a_\alpha$. This is the isomorphism $\lambda(n)$. Thus by the Five lemma 3.1, $m(n)$ is a quasi-isomorphism. This completes the inductive construction of $m : (C \otimes C_*(G), d) \rightarrow C_*(P)$. Since any singular chain in P lives in a compact subspace it must, in particular, be contained in some P_n . It follows from this, and the fact that each $m(n)$ is a quasi-isomorphism, that m is a quasi-isomorphism too.

Finally, by construction, $m(c_\alpha \otimes 1) = b_\alpha + w_\alpha$ projects to a cycle $z_\alpha \in C_*(P_n, P_{n-1})$ such that $C_*(p)z_\alpha$ represents c_α . This is precisely the condition that $\bar{m} : (C, \bar{d}) \rightarrow C_*(X)$ be a cellular chain model. \square

proof of Theorem 8.3: We are given a G -fibration $P \xrightarrow{p} X$ and a $C_*(G)$ -semifree resolution $m : M \xrightarrow{\cong} C_*(P)$. Let $g : Y \rightarrow X$ be a weak homotopy

equivalence from a CW complex Y (Theorem 1.4) and form the pullback

$$\begin{array}{ccc}
 Y \times_X P & \xrightarrow{\varphi} & P \\
 p_Y \downarrow & & \downarrow p \\
 Y & \xrightarrow{g} & X ;
 \end{array}$$

φ is a map of G -fibrations and a weak homotopy equivalence (Proposition 2.3).

Let $\mu : (C \otimes C_*(G), d) \xrightarrow{\cong} C_*(Y \times_X P)$ be a cellular chain model for our G -fibration; its existence is guaranteed by Proposition 8.4. Recall (diagram (8.2)) that μ factors to define

$$\bar{\mu} : (C \otimes C_*(G)) \otimes_{C_*(G)} \mathbb{k} \rightarrow C_*(Y) .$$

Since $(C \otimes C_*(G), d)$ is $C_*(G)$ -semifree we may, in the diagram

$$\begin{array}{ccc}
 & & M \\
 & \nearrow \text{dotted} & \downarrow \simeq m \\
 (C \otimes C_*(G), d) & \xrightarrow[\cong]{C_*(\varphi) \circ \mu} & C_*(P) ,
 \end{array}$$

lift $C_*(\varphi) \circ \mu$ through m to obtain a morphism $\nu : (C \otimes C_*(G), d) \rightarrow M$ and a $C_*(G)$ -linear map $h : C \otimes C_*(G) \rightarrow C_*(P)$ such that $m\nu - C_*(\varphi)\mu = dh + hd$ (apply Proposition 6.4 (ii)). Since m , $C_*(\varphi)$ and μ are quasi-isomorphisms so is ν . Thus (cf. Proposition 6.7 (ii))

$$\bar{\nu} = \nu \otimes_{C_*(G)} id_{\mathbb{k}} : (C \otimes C_*(G), d) \otimes_{C_*(G)} \mathbb{k} \rightarrow M \otimes_{C_*(G)} \mathbb{k}$$

is a quasi-isomorphism.

Finally, since h is $C_*(G)$ -linear we can form

$$\bar{h} : [C \otimes C_*(G)] \otimes_{C_*(G)} \mathbb{k} \xrightarrow{h \otimes id} C_*(P) \otimes_{C_*(G)} \mathbb{k} \xrightarrow{\overline{C_*(p)}} C_*(X) .$$

Evidently $\bar{m}\bar{\nu} - C_*(g)\bar{\mu} = d\bar{h} + \bar{h}d$. Since $\bar{\nu}$, $C_*(g)$ and $\bar{\mu}$ are quasi-isomorphisms, so is $\bar{m} : M \otimes_{C_*(G)} \mathbb{k} \rightarrow C_*(X)$. □

(c) The quasi-isomorphism theorem.

Suppose given

- a morphism $\alpha : G \rightarrow G'$ of topological monoids, and

- a commutative square of continuous maps

$$\begin{array}{ccc} P & \xrightarrow{\varphi} & P' \\ p \downarrow & & \downarrow p' \\ X & \xrightarrow{\psi} & X', \end{array}$$

where p is a G -fibration, p' is a G' -fibration and $\varphi(za) = \varphi(z)\alpha(a)$, $z \in P, a \in G$.

Then $C_*(\alpha)$ is a chain algebra morphism. Thus it makes any $C_*(G')$ -module (eg. $C_*(P')$) into a $C_*(G)$ -module. Moreover $C_*(\varphi)$ is a morphism of $C_*(G)$ -modules:

$$C_*(\varphi)(u \cdot x) = [C_*(\varphi)u] \cdot [C_*(\alpha)x], \quad u \in C_*(P), x \in C_*(G).$$

Theorem 8.5 *With the notation above, assume G is path connected and $C_*(\alpha)$ is a quasi-isomorphism. Then*

$$C_*(\varphi) \text{ is a quasi-isomorphism} \iff C_*(\psi) \text{ is a quasi-isomorphism.}$$

proof: The proof of Proposition 6.6 shows that $C_*(P)$ and $C_*(P')$ admit $C_*(G)$ and $C_*(G')$ semifree resolutions

$$m : (M, d) \xrightarrow{\simeq} C_*(P) \quad \text{and} \quad m' : (M', d) \xrightarrow{\simeq} C_*(P')$$

with M and M' concentrated in non-negative degrees. Since (M, d) is semifree and m' is a quasi-isomorphism we can find

$$f : (M, d) \rightarrow (M', d) \quad \text{and} \quad \theta : M \rightarrow C_*(P')$$

such that f is a morphism of $C_*(G)$ -modules, θ is $C_*(G)$ -linear and $m'f = C_*(\varphi)m + d\theta + \theta d$ (Proposition 6.4 (ii)).

Recall the notation of Theorem 6.12, which we wish to apply here, noting that $H_0(C_*(G)) = H_0(C_*(G')) = \mathbb{k}$. Diagram (8.2) and its analogue for the fibration p' yield the following diagram of chain complex morphisms:

$$\begin{array}{ccc} M \otimes_{C_*(G)} \mathbb{k} & \xrightarrow{f \otimes_{C_*(\alpha)} \mathbb{k}} & M' \otimes_{C_*(G')} \mathbb{k} \\ \bar{m} \downarrow \simeq & & \simeq \downarrow \bar{m}' \\ C_*(X) & \xrightarrow{C_*(\psi)} & C_*(X'). \end{array}$$

This diagram may *not* commute. However, because θ is $C_*(G)$ -linear it factors to give a linear map $\bar{\theta} : M \otimes_{C_*(G)} \mathbb{k} \rightarrow C_*(X')$ and $\bar{m}'(f \otimes_{C_*(\alpha)} \mathbb{k}) = C_*(\psi)\bar{m} +$

$d\bar{\theta} + \bar{\theta}d$. Thus $C_*(\varphi)$ is a quasi-isomorphism if and only if f is and $C_*(\psi)$ is a quasi-isomorphism if and only if $f \otimes_{C_*(\alpha)} k$ is. Now apply Theorem 6.12. \square

Theorem 8.5 has the following important corollary. Consider a fibre preserving map between Serre fibrations p and p' :

$$\begin{array}{ccc} X & \xrightarrow{f} & X' \\ p \downarrow & & \downarrow p' \\ Y & \xrightarrow{g} & Y' \end{array}$$

and let $f_y : X_y \rightarrow X'_{gy}$ be the restriction of f to a map between fibres.

Corollary to Theorem 8.5 *Assume Y and Y' are simply connected and X and X' are path connected. If $C_*(\Omega g)$ is a quasi-isomorphism then*

$$C_*(f) \text{ is a quasi-isomorphism} \iff C_*(f_y) \text{ is a quasi-isomorphism.}$$

proof: The construction in §2(c) of the holonomy fibration is natural. Thus there are commutative diagrams

$$\begin{array}{ccc} X \times_Y PY & \xrightarrow{f \times Pg} & X' \times_{Y'} PY' \\ \downarrow & & \downarrow \\ X & \xrightarrow{f} & X' \end{array} \quad \text{and} \quad \begin{array}{ccc} X_y & \xrightarrow{f_y} & X'_{gy} \\ \lambda \downarrow & & \downarrow \lambda' \\ X \times_Y PY & \xrightarrow{f \times Pg} & X' \times_{Y'} PY' \end{array}$$

with λ and λ' weak homotopy equivalences. Since Y and Y' are simply connected, ΩY and $\Omega Y'$ are path connected. Now apply Theorem 8.5 to the first diagram. \square

(d) The Whitehead-Serre theorem.

Theorem 8.6 (Whitehead-Serre) *Suppose k is a subring of \mathbb{Q} and $g : X \rightarrow Y$ is a continuous map between simply connected spaces. Then the following assertions are equivalent:*

- (i) $\pi_*(g) \otimes_{\mathbb{Z}} k$ is an isomorphism.
- (ii) $H_*(g; k)$ is an isomorphism.
- (iii) $H_*(\Omega g; k)$ is an isomorphism.

Remark Here $\pi_*(g) \otimes_{\mathbb{Z}} \mathbb{k}$ denotes the homomorphism $\pi_*(g) \otimes_{\mathbb{Z}} id_{\mathbb{k}} : \pi_*(X) \otimes_{\mathbb{Z}} \mathbb{k} \rightarrow \pi_*(Y) \otimes_{\mathbb{Z}} \mathbb{k}$. We emphasize the role of \mathbb{k} by using the full notation $C_*(-; \mathbb{k})$ and $H_*(-; \mathbb{k})$. When $\mathbb{k} = \mathbb{Z}$ the theorem reduces to Whitehead's original result: g is a weak homotopy equivalence if and only if $H_*(g; \mathbb{Z})$ is an isomorphism.

Lemma 8.7 *Suppose $\mathbb{k} \subset \mathbb{Q}$, X is an $(r-1)$ -connected space and either $r \geq 2$ or $r = 1$ and $\pi_1(X)$ is abelian. Then the Hurewicz homomorphism defines an isomorphism*

$$\pi_r(X) \otimes_{\mathbb{Z}} \mathbb{k} = H_r(X; \mathbb{k}).$$

proof: By Theorem 4.19 the Hurewicz homomorphism is an isomorphism $\pi_r(X) \xrightarrow{\cong} H_r(X; \mathbb{Z})$. Thus it defines an isomorphism $\pi_r(X) \otimes_{\mathbb{Z}} \mathbb{k} \xrightarrow{\cong} H_r(X; \mathbb{Z}) \otimes_{\mathbb{Z}} \mathbb{k}$. On the other hand the identification $C_*(X; \mathbb{Z}) \otimes_{\mathbb{Z}} \mathbb{k} = C_*(X; \mathbb{k})$ defines a map $H_*(X; \mathbb{Z}) \otimes_{\mathbb{Z}} \mathbb{k} \rightarrow H_*(X; \mathbb{k})$. Because $\mathbb{k} \subset \mathbb{Q}$ the operation $- \otimes_{\mathbb{Z}} \mathbb{k}$ preserves exactness, and it follows that this map too is an isomorphism. \square

We shall make frequent use of Eilenberg-MacLane spaces (§4(f)). (The reader may wish to review §4(f), since we shall often use there properties established without explicit reference.) Finally, we shall also rely on the

Proposition 8.8 *Suppose $\mathbb{k} \subset \mathbb{Q}$ and X is an Eilenberg-MacLane space of type (π, n) , $n \geq 1$, with π abelian. Then*

$$\pi \otimes_{\mathbb{Z}} \mathbb{k} = 0 \Leftrightarrow H_*(X; \mathbb{k}) = H_*(pt; \mathbb{k}).$$

proof: Since $\pi \otimes_{\mathbb{Z}} \mathbb{k} \cong H_n(X; \mathbb{k})$ we have only to prove that if $\pi \otimes_{\mathbb{Z}} \mathbb{k} = 0$ then $H_*(X; \mathbb{k}) = H_*(pt; \mathbb{k})$.

Case 1: $n = 1$ and π is cyclic.

Since $\pi \otimes_{\mathbb{Z}} \mathbb{k} = 0$, there is a short exact sequence

$$0 \rightarrow \mathbb{Z} \xrightarrow{\lambda} \mathbb{Z} \xrightarrow{\zeta} \pi \rightarrow 0,$$

where λ is a multiplication by an integer k invertible in \mathbb{k} . Let $f : K(\mathbb{Z}, 2) \rightarrow K(\pi, 2)$ be a map such that $\pi_2(f) = \zeta$ and convert f to a fibration

$$F \xrightarrow{i} E \xrightarrow{p} K(\pi, 2).$$

The long exact homotopy sequence identifies F as an Eilenberg-MacLane space of type $(\mathbb{Z}, 2)$ and identifies $\pi_2(i)$ with the homomorphism $\lambda : \mathbb{Z} \rightarrow \mathbb{Z}$.

Now consider the commutative square

$$\begin{array}{ccc} \Omega F & \xrightarrow{\Omega i} & \Omega E \\ \downarrow & & \downarrow \Omega p \\ \{pt\} & \longrightarrow & \Omega K(\pi, 2) \end{array}$$

as a map of ΩF -fibrations, where the right hand side is the loop space fibration described in §2(b). The long exact homotopy sequences for the path space fibrations identify ΩF and ΩE as Eilenberg-MacLane spaces of type $(\mathbb{Z}, 1)$ and identify $\pi_1(\Omega i)$ with λ . Thus $H_1(\Omega i; \mathbb{k}) = \pi_1(\Omega i) \otimes_{\mathbb{Z}} \mathbb{k}$ is an isomorphism.

Moreover, because the universal cover, \mathbb{R} , of S^1 is contractible it follows that S^1 is an Eilenberg-MacLane space of type $(\mathbb{Z}, 1)$. Since all Eilenberg-MacLane spaces of the same type have the same homology, $H_i(\Omega E; \mathbb{k}) = H_i(\Omega F; \mathbb{k}) = 0, i \geq 2$, and so $H_*(\Omega i, \mathbb{k})$ is an isomorphism.

We can therefore apply Theorem 8.5 to the map of ΩF -fibrations above to conclude that $H_*(\Omega K(\pi, 2); \mathbb{k}) = H_*(pt; \mathbb{k})$. But $\Omega K(\pi, 2)$ is an Eilenberg-MacLane space of type $(\pi, 1)$ and hence has the weak homotopy type of X , whence $H_*(X; \mathbb{k}) = H_*(pt; \mathbb{k})$.

Case 2: π is cyclic.

We induct on n , the case $n = 1$ having been established in Case 1. Consider

$$\begin{array}{ccc} \{pt\} & \longrightarrow & PX \\ \downarrow & & \downarrow \\ \{pt\} & \longrightarrow & X \end{array}$$

as a map from an $\{e\}$ -fibration to the ΩX -path space fibration on X ; $\{e\}$ denoting the 1-point monoid. By the induction hypothesis, $H_*(\{e\}; \mathbb{k}) \xrightarrow{\cong} H_*(\Omega X; \mathbb{k})$, since ΩX is an Eilenberg-MacLane space of type $(\pi, n - 1)$. Apply Theorem 8.5 to conclude that $H_*(pt; \mathbb{k}) \xrightarrow{\cong} H_*(X; \mathbb{k})$.

Case 3: The general case.

It is easy to modify the construction in §4(f) of cellular Eilenberg-MacLane spaces to construct a $K(\pi, n)$ that is the union of sub CW complexes $K(\pi_\alpha, n)$ as π_α runs through the finitely generated subgroups of π , and such that $K(\pi_\alpha, n) \rightarrow K(\pi, n)$ induces the inclusion $\pi_\alpha \rightarrow \pi$. We may also assume that for any α_1, α_2 there is a β such that $K(\pi_\beta, n) \supset K(\pi_{\alpha_i}, n), i = 1, 2$. Since $- \otimes_{\mathbb{Z}} \mathbb{k}$ is exact, each $\pi_\alpha \otimes_{\mathbb{Z}} \mathbb{k} = 0$. If we can show that each $H_*(K(\pi_\alpha; n); \mathbb{k}) = H_*(pt; \mathbb{k})$ it will automatically follow (eg via cellular chains) that $H_*(K(\pi, n); \mathbb{k}) = H_*(pt; \mathbb{k})$. Since X has the weak homotopy type of $K(\pi, n)$ this will complete the proof.

We may therefore as well assume that X is one of the $K(\pi_\alpha, n)$; i.e., that π is finitely generated. Then π is the finite direct sum $\Gamma_1 \oplus \dots \oplus \Gamma_m$ of cyclic groups and each $\Gamma_i \otimes_{\mathbb{Z}} \mathbb{k} = 0$. Thus X has the weak homotopy type of the product $\prod_{i=1}^m K(\Gamma_i, n)$, and, by Case 2, there are chain equivalences $\mathbb{k} \xrightarrow{\cong} C_*(K(\Gamma_i, n); \mathbb{k})$. Since the tensor product of chain equivalences is a chain equivalence, the Eilenberg-Zilber chain equivalence gives

$$\mathbb{k} \xrightarrow{\cong} \bigotimes_{i=1}^m C_*(K(\Gamma_i, n); \mathbb{k}) \xrightarrow{EZ} C_*\left(\prod_{i=1}^m K(\Gamma_i, n); \mathbb{k}\right).$$

Thus $H_*(X; \mathbb{k}) = H_*(pt; \mathbb{k})$. □

proof of Theorem 8.6: Apply the Cellular models theorem 1.4 and the Whitehead lifting lemma 1.5 to obtain a based homotopy commutative diagram

$$\begin{array}{ccc} X' & \xrightarrow{g'} & Y' \\ h_X \downarrow & & \downarrow h_Y \\ X & \xrightarrow{g} & Y \end{array}$$

in which X' and Y' are CW complexes and h_X and h_Y are weak homotopy equivalences. Since Ωh_X and Ωh_Y are also weak homotopy equivalences it is enough to prove the theorem for g' : i.e., we may assume X and Y are CW complexes, which we now do.

Our first step is to reduce to the case that $\pi_2(g)$ is surjective. Let $\Gamma = \pi_2(Y)/\text{Im } \pi_2(g)$ and let $K = K(\Gamma, 2)$. Use Proposition 4.20 to find a continuous map $q : Y \rightarrow K$ such that $\pi_2(q)$ is the quotient homomorphism. Thus $\pi_2(qg) = 0$ and so qg is based homotopic to the constant map.

In §2(c) we showed how to convert q to a fibration \hat{q} via the commutative diagram

$$\begin{array}{ccc} Y & \xrightarrow[\simeq]{\lambda} & Y \times_K MK \\ & \searrow q & \swarrow \hat{q} \\ & & K \end{array}$$

in which λ is a homotopy equivalence. Since $\hat{q} \lambda g$ is homotopic to the constant map and \hat{q} is a fibration we may lift the homotopy to a homotopy $\lambda g \sim g_1$ with g_1 mapping X into the fibre $Y \times_K PK$. By the long exact homotopy sequence, $\pi_2(g_1)$ is surjective, and we claim it is sufficient to prove the theorem for g_1 .

In fact the claim follows from the assertion that if $i : Y \times_K PK \rightarrow Y \times_K MK$ is the inclusion then $\pi_*(i) \otimes \mathbb{k}$, $H_*(i; \mathbb{k})$ and $H_*(\Omega i; \mathbb{k})$ are all isomorphisms, which we see as follows. The Hurewicz theorem 4.19 identifies $H_2(g) = \pi_2(g) = \pi_1(\Omega g) = H_1(\Omega g)$. Hence under any of the three assertions of the theorem, $\pi_2(g) \otimes_{\mathbb{Z}} \mathbb{k}$ is an isomorphism. Since $- \otimes_{\mathbb{Z}} \mathbb{k}$ is exact $\Gamma \otimes_{\mathbb{Z}} \mathbb{k} = 0$, and so $\pi_*(i) \otimes_{\mathbb{Z}} \mathbb{k}$ is an isomorphism.

Moreover Proposition 8.8 asserts that $H_*(K; \mathbb{k}) = \mathbb{k} = H_*(\Omega K; \mathbb{k})$. Apply the Corollary to Theorem 8.5 to the fibre preserving map

$$\begin{array}{ccc} Y \times_K PK & \xrightarrow{i} & Y \times_K MK \\ \downarrow & & \downarrow \hat{q} \\ pt & \xrightarrow{\quad} & K \end{array}$$

to conclude that $H_*(i; \mathbb{k})$ is an isomorphism. On the other hand, $\pi_2(\hat{q})$ is surjective since $\pi_2(q)$ is. Thus $\pi_2(i)$ is injective and $Y \times_K PK$ is simply connected. Looping the diagram above gives a map of $\Omega(Y \times_K PK)$ -fibrations. Since $\Omega(Y \times_K PK)$ is path connected Theorem 8.5 can be applied to deduce that $H_*(\Omega i; \mathbb{k})$ is an isomorphism.

In view of this discussion *we may and do henceforth assume that $\pi_2(g)$ is surjective.* We first establish that assertions (i) and (ii) are equivalent.

Convert g into the fibration

$$p : X \times_Y MY \rightarrow Y$$

as described in §2(c). The fibre of p is $X \times_Y PY$ and the homotopy equivalence $X \xrightarrow{\cong} X \times_Y MY$ identifies g with p . Thus the long exact homotopy sequence shows that $X \times_Y PY$ is simply connected. Moreover, since $- \otimes_{\mathbb{Z}} \mathbb{k}$ is exact,

$$\pi_*(g) \otimes \mathbb{k} \text{ is an isomorphism} \iff \pi_*(X \times_Y PY) \otimes \mathbb{k} = 0.$$

On the other hand (cf. §2(c)),

$$\begin{array}{ccc} X \times_Y PY & \xrightarrow{\text{proj}} & PY \\ \rho_X \downarrow & & \downarrow \rho \\ X & \xrightarrow{g} & Y \end{array}$$

is a morphism of ΩY -fibrations. Thus Theorem 8.5 asserts that

$$H_*(g; \mathbb{k}) \text{ is an isomorphism} \iff H_*(X \times_Y PY; \mathbb{k}) = H_*(pt; \mathbb{k}),$$

Let $F \rightarrow X \times_Y PY$ be a cellular model. We have only to show that

$$\pi_*(F) \otimes_{\mathbb{Z}} \mathbb{k} = 0 \iff H_*(F; \mathbb{k}) = H_*(pt; \mathbb{k}). \tag{8.9}$$

Define a sequence $\{F_r\}_{r \geq 1}$ of r -connected CW complexes, beginning with $F_1 = F$, as follows. Given F_r ; put $K_{r+1} = K(\pi_{r+1}(F_r), r+1)$ and choose a continuous map

$$\theta_r : F_r \rightarrow K_{r+1}$$

so that $\pi_{r+1}(\theta_r)$ is the identity isomorphism. Then let F_{r+1} be a cellular model for the homotopy fibre $F_r \times_{K_{r+1}} PK_{r+1}$ of θ_r .

As described in §2(c) we have a morphism of ΩK_{r+1} -fibrations,

$$\begin{array}{ccc} F_r \times_{K_{r+1}} PK_{r+1} & \xrightarrow{\bar{\theta}_r} & PK_{r+1} \\ \rho_r \downarrow & & \downarrow \rho \\ F_r & \xrightarrow{\theta_r} & K_{r+1}. \end{array} \tag{8.10}$$

Moreover, the long exact homotopy sequence has the form

$$\dots \xrightarrow{\partial} \pi_n(F_r \times_{K_{r+1}} PK_{r+1}) \xrightarrow{\pi_n(\rho_r)} \pi_n(F_r) \xrightarrow{\pi_n(\theta_r)} \pi_n(K_{r+1}) \xrightarrow{\partial} \dots$$

It follows that $F_r \times_{K_{r+1}} PK_{r+1}$ is indeed $(r + 1)$ -connected and that $\pi_n(\rho_r)$ is an isomorphism for $n \geq r + 2$. Thus we have isomorphisms

$$\pi_{r+1}(F_r) \xrightarrow{\cong} \pi_{r+1}(F_{r-1}) \xrightarrow{\cong} \dots \xrightarrow{\cong} \pi_{r+1}(F), \quad r \geq 1.$$

Suppose now that $H_*(F; \mathbb{k}) = H_*(pt; \mathbb{k})$. We show by induction on r that $H_*(F_r; \mathbb{k}) = H_*(pt; \mathbb{k})$, noting that this is true by hypothesis for $r = 1$. If this holds for some r then $\pi_{r+1}(F_r) \otimes_{\mathbb{Z}} \mathbb{k} = H_{r+1}(F_r; \mathbb{k}) = 0$ and so Proposition 8.8 asserts that $H_*(K_{r+1}; \mathbb{k}) = H_*(pt; \mathbb{k})$. Hence $H_*(\theta_r; \mathbb{k})$ is an isomorphism. Now Theorem 8.5, applied to the diagram (8.10), asserts that $H_*(\tilde{\theta}_r; \mathbb{k})$ is an isomorphism, whence

$$H_*(F_{r+1}; \mathbb{k}) \cong H_*(F_r \times_{K_{r+1}} PK_{r+1}) \cong H_*(PK_{r+1}; \mathbb{k}) = H_*(pt; \mathbb{k}).$$

Since this is true for every r , the homotopy group isomorphisms above show that

$$\pi_{r+1}(F) \otimes_{\mathbb{Z}} \mathbb{k} \cong \pi_{r+1}(F_r) \otimes_{\mathbb{Z}} \mathbb{k} = H_{r+1}(F_r; \mathbb{k}) = 0, \quad r \geq 1,$$

as desired.

Conversely, suppose $\pi_i(F) \otimes_{\mathbb{Z}} \mathbb{k} = 0$, $i \geq 2$. Then the homotopy group isomorphisms above show that $\pi_i(F_r) \otimes_{\mathbb{Z}} \mathbb{k} = 0$ for all $i \geq 2$ and $r \geq 1$. In particular, $\pi_{r+1}(F_r \otimes_{\mathbb{Z}} \mathbb{k}) = 0$. On the other hand, if $r \geq 1$ then ΩK_{r+1} is an Eilenberg-MacLane space of type $(\pi_{r+1}(F), r + 1)$. Hence (Proposition 8.8) $H_*(\Omega K_{r+1}; \mathbb{k}) = H_*(pt; \mathbb{k})$ for $r \geq 1$. Consider the diagram

$$\begin{array}{ccc} F_r \times_{K_{r+1}} PK_{r+1} & \xrightarrow{id} & F_r \times_{K_{r+1}} PK_{r+1} \\ \downarrow id & & \downarrow \rho_r \\ F_r \times_{K_{r+1}} PK_{r+1} & \xrightarrow{\rho_r} & F_r \end{array}$$

as a morphism from an $\{e\}$ -fibration to an ΩK_{r+1} -fibration, $\{e\}$ denoting the 1-point monoid. Apply Theorem 8.5 to conclude that $H_*(\rho_r; \mathbb{k})$ is an isomorphism, $r \geq 1$. This gives a sequence of isomorphisms

$$\xrightarrow{\cong} H_*(F_{r+1}; \mathbb{k}) \xrightarrow{\cong} H_*(F_r; \mathbb{k}) \xrightarrow{\cong} \dots \xrightarrow{\cong} H_*(F_1; \mathbb{k}) = H_*(F; \mathbb{k}).$$

Since F_r is r -connected it follows that $H_*(F; \mathbb{k}) = H_*(pt; \mathbb{k})$.

This completes the proof that assertions (i) and (ii) are equivalent. To see that (ii) and (iii) are equivalent we recall that we may assume $\pi_2(g)$ is surjective

and we use the notation and constructions above. Theorem 8.5, applied to

$$\begin{array}{ccc} PX & \xrightarrow{Pg} & PY \\ \downarrow & & \downarrow \\ X & \xrightarrow{g} & Y \end{array}$$

implies that if $H_*(\Omega g; \mathbb{k})$ is an isomorphism so is $H_*(g; \mathbb{k})$.

Conversely, suppose $H_*(g; \mathbb{k})$ is an isomorphism. Let $F_g = X \times_Y PY$ denote the homotopy fibre of g . Then, as shown above, $H_*(F_g; \mathbb{k}) = \mathbb{k}$ and $\pi_*(g) \otimes_{\mathbb{Z}} \mathbb{k}$ is an isomorphism.

On the other hand, in §2(c) we constructed an ΩX -fibration $q : P'X \times_X F_g \rightarrow F_g$ such that the fibre inclusion $j : \Omega X \rightarrow P'X \times_X F_g$ was identified with Ωg by a homotopy equivalence. Thus $\pi_*(j) \otimes_{\mathbb{Z}} \mathbb{k}$ is an isomorphism by hypothesis and we have only to show that $H_*(j; \mathbb{k})$ is an isomorphism.

But the commutative diagram

$$\begin{array}{ccc} \Omega X & \xrightarrow{j} & P'X \times_X F_g \\ \downarrow & & \downarrow q \\ \{pt\} & \xrightarrow{\quad} & F_g \end{array}$$

is a map of ΩX -fibrations and the map $\{pt\} \rightarrow F_g$ induces an isomorphism in homology. Now Theorem 8.5 asserts that $H_*(j; \mathbb{k})$ is an isomorphism too. □

Exercises

1. Let $\mathbb{k}[G] = \{\sum_{g \in G} \lambda_g g, \lambda_g \in \mathbb{k}\}$, where λ_g takes the value zero except on a finite number of elements of G , be the *group ring* of a group G . Construct a quasi-isomorphism $(\mathbb{k}[G], 0) \xrightarrow{\cong} C_*(G; \mathbb{k})$. If $P \rightarrow X$ is a G -fibration (for instance a finite covering) prove that there exists a quasi-isomorphism of $\mathbb{k}[G]$ -modules $\mathbb{k}[G] \otimes C_*(X; \mathbb{k}) \xrightarrow{\cong} C_*(P; \mathbb{k})$.

2. Let $\sigma \in C_1(S^1; \mathbb{k})$ be defined by $\sigma(t) = e^{2i\pi t}$. Prove that σ is a cycle such that $\sigma^2 = 0$. Construct a quasi-isomorphism of algebras $(\wedge x, 0) \rightarrow C_*(S^1)$.

3. Let T be the torus $S^1 \times S^1 \times \dots \times S^1$ (n times). Deduce from exercise 2 a quasi-isomorphism of algebras $\varphi : (\wedge(x_1, x_2, \dots, x_n), 0) \rightarrow C_*(T)$. Assume that T acts from the right on a topological space X . Prove that $C^*(X; \mathbb{k})$ inherits, via φ , a left $(\wedge(x_1, x_2, \dots, x_n), 0)$ -module structure.

4. Let $F \rightarrow X \rightarrow Y$ be a fibration with Y 1-connected and consider the associated ΩY -fibration $\Omega Y \rightarrow F \rightarrow X$. Prove that if $H_*(F; \mathbb{k})$ is a free $H_*(\Omega Y; \mathbb{k})$ -module, then $H_*(X; \mathbb{k}) \cong \mathbb{k} \otimes_{H_*(\Omega Y; \mathbb{k})} H_*(F; \mathbb{k})$.

5. Prove that the spaces $X = \mathbb{R}P^m \times S^n$ and $Y = S^m \times \mathbb{R}P^n$ have the same homotopy groups but not the same homology groups. Does this contradict the Whitehead theorem?
6. Let $P \rightarrow X$ be a G -fibration with X 1-connected. Prove that if $(T(V), d) \xrightarrow{\cong} C_*(\Omega G)$ is a quasi-isomorphism of chain algebras then there is a weak equivalence $C^*(X) \xrightarrow{\cong} \text{Hom}_{T(V)}(T(V) \otimes M, Ik)$, and describe the semifree module $TV \otimes M$.

9 \mathcal{P} -local and rational spaces

Fix a set \mathcal{P} of prime numbers and let \mathcal{I} be the set of integers k relatively prime to the elements of \mathcal{P} . An abelian group π is \mathcal{P} -local if multiplication by k in π is an isomorphism for all $k \in \mathcal{I}$. The rational numbers m/k , $k \in \mathcal{I}$, are a subring $\mathbb{k} \subset \mathbb{Q}$, so π is \mathcal{P} -local if and only if it is a \mathbb{k} -module. By convention, when $\mathcal{P} = \emptyset$ we take $\mathbb{k} = \mathbb{Q}$ — in this case π is a rational vector space. *Throughout this section our ground ring \mathbb{k} will be the subring associated in this way with the set of primes \mathcal{P} .*

If $0 \rightarrow \pi' \rightarrow \pi \rightarrow \pi'' \rightarrow 0$ is a short exact sequence of abelian groups, then π' and π'' are \mathcal{P} -local if and only if π is \mathcal{P} -local. For any abelian group π , $\pi \otimes_{\mathbb{Z}} \mathbb{k}$ is \mathcal{P} -local. Moreover, if π is \mathcal{P} -local then $\pi \rightarrow \pi \otimes_{\mathbb{Z}} \mathbb{k}$ is an isomorphism. For general π this homomorphism

$$\pi \rightarrow \pi \otimes_{\mathbb{Z}} \mathbb{k}, \quad \gamma \mapsto \gamma \otimes 1$$

is called its \mathcal{P} -localization.

The idea of \mathcal{P} -local spaces and localization of spaces, introduced by Sullivan in [143], is a topological analogue. As will be shown in Theorem 9.3, if X is a simply connected space then

$$\pi_*(X) \text{ is } \mathcal{P}\text{-local} \iff H_*(X, pt; \mathbb{Z}) \text{ is } \mathcal{P}\text{-local.}$$

This motivates the

Definition A simply connected space X is a \mathcal{P} -local space if it satisfies these equivalent conditions. When $\mathbb{k} = \mathbb{Q}$ (i.e., $\mathcal{P} = \emptyset$) X is called a *rational space*.

This section is organized into the topics:

- (a) \mathcal{P} -local spaces.
- (b) Localization.
- (c) Rational homotopy type.

(a) \mathcal{P} -local spaces.

Before turning to the proof of Theorem 9.3, we introduce an important class of \mathcal{P} -local spaces: the (relative) $CW_{\mathcal{P}}$ -complexes, beginning with the classical motivating example: *the infinite telescope* $S_{\mathcal{P}}^n$.

Let k_1, k_2, \dots be the positive integers relatively prime to \mathcal{P} (i.e.; the denominators of \mathbb{k}). Put

$$S_{\mathcal{P}}^n = \left(\bigvee_{i=0}^{\infty} S_i^n \right) \cup_h \left(\prod_{j=1}^{\infty} D_j^{n+1} \right),$$

where D_j^{n+1} is attached by a map $S^n \rightarrow S_{j-1}^n \vee S_j^n$ representing $[S_{j-1}^n] - k_j[S_j^n]$. For $n = 1$ this is illustrated by the picture

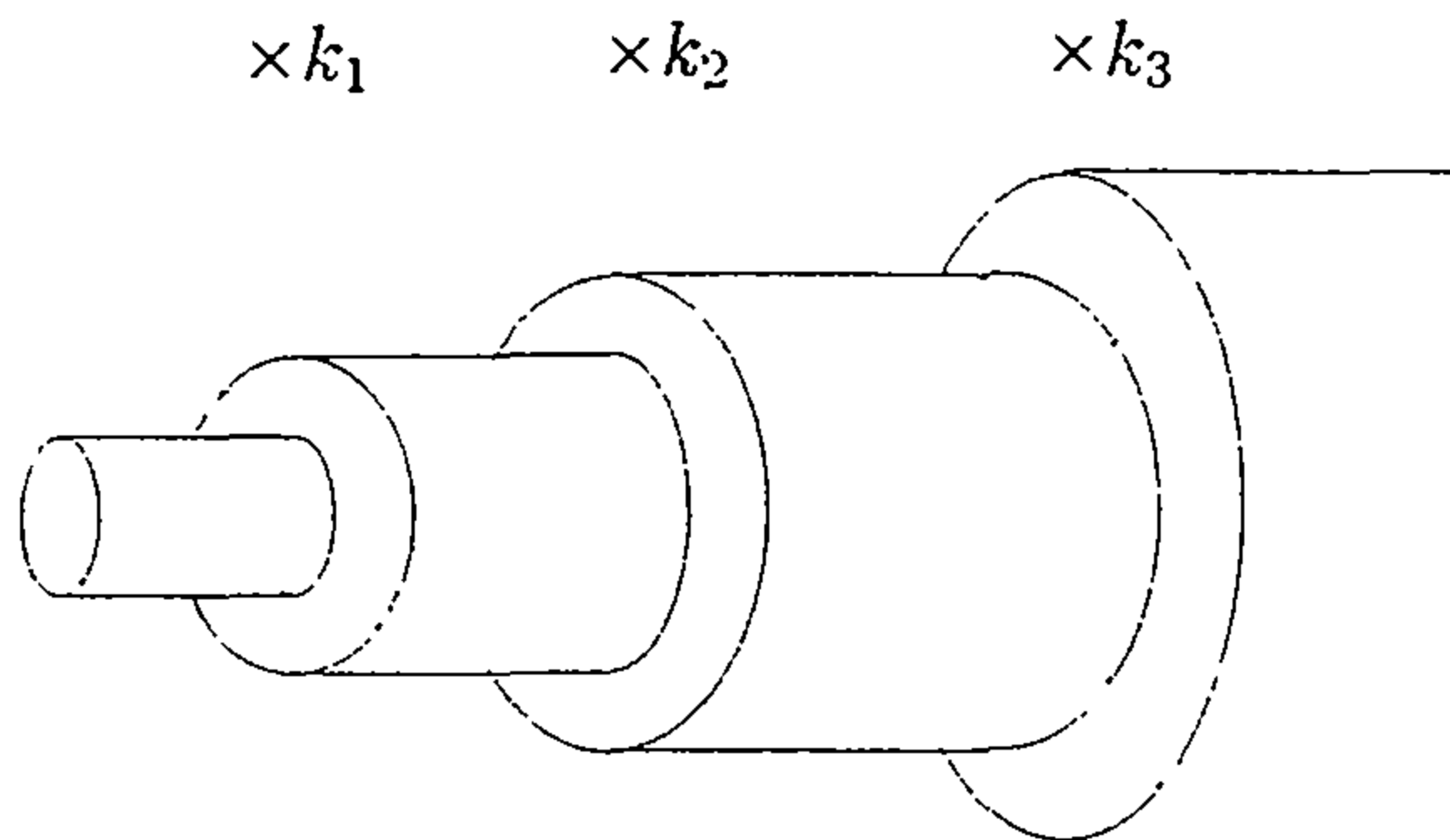

in which the $(j - 1)^{\text{st}}$ right hand circle is attached to the j^{th} left hand circle by the map $e^{2\pi it} \mapsto e^{2\pi i k_j t}$, and the bottom solid lines are identified to a single point. (This explains the terminology: ‘telescope’.)

The space $S_{\mathcal{P}}^n$ is called the \mathcal{P} -local n -sphere and the space $D_{\mathcal{P}}^{n+1} = S_{\mathcal{P}}^n \times I / S_{\mathcal{P}}^n \times \{0\}$ is called the \mathcal{P} -local $(n + 1)$ -disk. When $\mathcal{P} = \mathbb{Q}$ these spaces are called the rational n -sphere $S_{\mathbb{Q}}^n$ and the rational $(n + 1)$ -disk, $D_{\mathbb{Q}}^{n+1}$. The inclusion of the initial sphere $S_0^n \rightarrow S_{\mathcal{P}}^n$ extends to $D^{n+1} \rightarrow D_{\mathcal{P}}^{n+1}$ and this inclusion

$$(D^{n+1}, S^n) \rightarrow (D_{\mathcal{P}}^{n+1}, S_{\mathcal{P}}^n)$$

is called the natural inclusion of the initial disk and sphere. (This is the simplest example of \mathcal{P} -localization of topological spaces, defined and constructed later in this section.)

Now we compute the homology of $S_{\mathcal{P}}^n$, showing that

$$H_i(S_{\mathcal{P}}^n; \mathbb{Z}) = \begin{cases} \mathbb{Z} & i = 0 \\ \mathcal{P} & i = n \\ 0 & \text{otherwise} \end{cases},$$

with the generator $1 \in H_n(S_{\mathcal{P}}^n; \mathbb{Z})$ represented by the initial sphere $[S_0^n]$. For this, let $X(r) \subset S_{\mathcal{P}}^n$ be the sub complex $\bigvee_{i=0}^r S_i^n \cup_h \left(\prod_{j=1}^r D_j^{n+1} \right)$. It contains S_r^n as a strong deformation retract: simply collapse the finite telescope $X(r)$ onto this terminal sphere. Hence $H_*(X(r); \mathbb{Z})$ vanishes in degrees $i \neq 0, n$, and so $H_*(S_{\mathcal{P}}^n; \mathbb{Z})$ vanishes in these degrees as well. The inclusion $X(r) \subset X(r + 1)$ sends $[S_r^n]$ to $k_{r+1}[S_{r+1}^n]$. Thus an isomorphism $H_n(S_{\mathcal{P}}^n; \mathbb{Z}) \cong \mathcal{P}$ is given by mapping each $[S_r^n]$ to $(\prod_{j=1}^r k_j)^{-1}$.

When $n \geq 2$, $S_{\mathcal{P}}^n$ is simply connected since its cells, aside from the base point, all have dimension n or $n + 1$ (apply the Cellular approximation theorem 1.2). Thus $S_{\mathcal{P}}^n, n \geq 1$, is indeed a \mathcal{P} -local space.

When $n = 1$, $S_{\mathcal{P}}^1$ is an Eilenberg-MacLane space of type $(\mathcal{P}, 1)$. Indeed any map $S^m \rightarrow S_{\mathcal{P}}^1$ has image in some $X(r)$, by compactness. Since $X(r) \simeq S^1$ it follows that $\pi_m(S_{\mathcal{P}}^1) = 0, m \geq 2$ and $\pi_1(S_{\mathcal{P}}^1)$ is abelian. Thus $\pi_1(S_{\mathcal{P}}^1) \cong H_1(S_{\mathcal{P}}^1) \cong \mathcal{P}$.

Relative $CW_{\mathcal{P}}$ complexes are built by assembling \mathcal{P} -local disks via attaching maps from \mathcal{P} -local spheres in exactly the way classical relative CW complexes are constructed from ordinary disks. More precisely,

Definition A *relative $CW_{\mathcal{P}}$ complex* is a topological pair (X, A) together with a filtration $X = \bigcup_{n=-1}^{\infty} X_{(n)}$ of X by closed subspaces $X_{(n)}$ such that

- $X_{(1)} = X_{(0)} = X_{(-1)} = A$, and A is 1-connected.
- For $n \geq 1$, $X_{(n+1)}$ is presented as

$$X_{(n+1)} = X_{(n)} \cup_{f_n} \left(\coprod_{\alpha} D_{\mathcal{P}, \alpha}^{n+1} \right), \quad (9.1)$$

with $f_n : \coprod_{\alpha} S_{\mathcal{P}, \alpha}^n \rightarrow X_{(n)}$ a cellular map. The $D_{\mathcal{P}, \alpha}^{n+1}$ are called the \mathcal{P} -local $(n+1)$ -cells of (X, A) . If $A = \{pt\}$ then X is a $CW_{\mathcal{P}}$ complex. When $k = \mathbb{Q}$ we refer to *(relative) $CW_{\mathbb{Q}}$* .

Remark Since $S_{\mathcal{P}}^n$ is a subcomplex of the CW complex $D_{\mathcal{P}}^{n+1}$ and since f_n is cellular, the adjunction space $X_{(n)} \cup_{f_n} \left(\coprod_{\alpha} D_{\mathcal{P}}^{n+1} \right)$ carries an induced structure as a relative CW complex with respect to A . This makes (X, A) into a relative CW complex in which each $X_{(n)}$ is a subcomplex. Since $(D_{\mathcal{P}}^{n+1}, S_{\mathcal{P}}^n)$ has only $(n+1)$ -cells and $(n+2)$ -cells, it follows that

$$X_n \subset X_{(n)} \subset X_{n+1}, \quad n \geq -1,$$

where X_n is the n -skeleton of the relative CW complex (X, A) . We call $X_{(n)}$ the *n -skeleton of the $CW_{\mathcal{P}}$ -structure* on (X, A) . In particular (X, A) has no 0-cells or 1-cells and so every circle in X is homotopic to a circle in the 1-connected space A ; i.e., X is simply connected.

Finally, as follows from the calculation above of $H_*(S_{\mathcal{P}}^n; \mathbb{Z})$, $H_*(D_{\mathcal{P}}^{n+1}, S_{\mathcal{P}}^n; \mathbb{Z})$ is a free k -module concentrated in degree n . It follows by excision that each $H_*(X_{(n+1)}, X_{(n)}; \mathbb{Z})$ is \mathcal{P} -local. The long exact homology sequences now shows that $H_*(X, pt; \mathbb{Z})$ is \mathcal{P} -local: thus X is a \mathcal{P} -local space.

We turn now to the statement and proof of Theorem 9.3. This will make frequent use (without reference) of the following elementary remark.

Lemma 9.2 *Let \mathbb{F}_p be the prime field of characteristic p . Then for all pairs of spaces (X, A) :*

$$H_*(X, A; \mathbb{Z}) \text{ is } \mathcal{P}\text{-local} \iff H_*(X, A; \mathbb{F}_p) = 0, \quad p \notin \mathcal{P}.$$

In particular

$$H_*(X, pt; \mathbb{Z}) \text{ is } \mathcal{P}\text{-local} \iff H_*(X; \mathbb{F}_p) = H_*(pt; \mathbb{F}_p), \quad p \notin \mathcal{P}.$$

proof: Consider the long exact homology sequence associated with the short exact sequence

$$0 \rightarrow C_*(X, A; \mathbb{Z}) \xrightarrow{\times p} C_*(X, A; \mathbb{Z}) \rightarrow C_*(X, A; \mathbb{F}_p) \rightarrow 0.$$

It shows that multiplication by p in $H_*(X, A; \mathbb{Z})$ is an isomorphism precisely when $H_*(X, A; \mathbb{F}_p) = 0$. \square

Theorem 9.3 *Let X be a simply connected topological space. Then the following conditions are equivalent:*

- (i) $\pi_*(X)$ is \mathcal{P} -local.
- (ii) $H_*(X, pt; \mathbb{Z})$ is \mathcal{P} -local.
- (iii) $H_*(\Omega X, pt; \mathbb{Z})$ is \mathcal{P} -local.

proof: This is essentially identical to the proof of Theorem 8.6. We begin, as in that Theorem, with the case of Eilenberg-MacLane spaces, where we follow closely the steps of the proof of Proposition 8.8:

Lemma 9.4 *If X is an Eilenberg-MacLane space of type (π, n) , $n \geq 1$, then*

$$\pi \text{ is } \mathcal{P}\text{-local} \implies H_*(X; \mathbb{F}_p) = H_*(pt; \mathbb{F}_p), p \notin \mathcal{P}.$$

proof: Suppose first that $n = 1$. Reduce to the case π is finitely generated exactly as in Case 3 in the proof of Theorem 8.6. Since \mathbb{k} is a principal ideal domain, finitely generated \mathbb{k} -modules are the finite direct sums of cyclic \mathbb{k} -modules. Hence in this case X has the weak homotopy type of a finite product of spaces $K(\Gamma_i, 1)$ with Γ_i a cyclic \mathbb{k} -module. Exactly as in the proof of Case 3 in (8.6) we are reduced to the case π is a cyclic \mathbb{k} -module.

If $\pi \cong \mathbb{k}$ then X has the weak homotopy type of $S_{\mathcal{P}}^1$ and $H_*(X, pt; \mathbb{Z})$ is \mathcal{P} -local by the calculation above of the homology of $S_{\mathcal{P}}^1$. If $\pi \not\cong \mathbb{k}$ then there is a short exact sequence of \mathbb{k} -modules of the form

$$0 \rightarrow \mathbb{k} \rightarrow \mathbb{k} \rightarrow \pi \rightarrow 0.$$

Exactly as in Case 1 of Proposition 8.8, this leads to a morphism of ΩF -fibrations of the form

$$\begin{array}{ccc} \Omega F & \xrightarrow{\Omega i} & \Omega E \\ \downarrow & & \downarrow \Omega \rho \\ pt & \longrightarrow & \Omega K(\pi, 2) \end{array}$$

in which both ΩF and ΩE are Eilenberg-MacLane spaces of type $(k, 1)$. Thus as observed above both ΩF and ΩE have the weak homotopy type of $S_{\mathcal{P}}^1$. Hence $H_*(\Omega F; \mathbb{F}_p) = H_*(\Omega E; \mathbb{F}_p) = H_*(pt, \mathbb{F}_p)$. Thus Theorem 8.5 asserts that $H_*(pt; \mathbb{F}_p) \xrightarrow{\cong} H_*(\Omega K(\pi, 2); \mathbb{F}_p)$. Since $\Omega K(\pi, 2)$ has the weak homotopy type of X , the Lemma holds for X .

This establishes Lemma 9.4 for Eilenberg-MacLane spaces of type $(\pi, 1)$. The case when X has type (π, n) , $n > 1$, follows by induction on n ; apply Theorem 8.5 to the morphism of ΩX -fibrations

$$\begin{array}{ccc} \Omega X & \longrightarrow & PX \\ \downarrow & & \downarrow \\ pt & \longrightarrow & X. \end{array}$$

□

We now return to Theorem 9.3, whose proof mimics the proof of formula (8.9), with X replacing F and \mathbb{F}_p replacing k . Thus we construct a sequence of spaces $\{X_r\}_{r \geq 1}$ starting with a cellular model $X_1 \rightarrow X$, and a sequence of maps

$$\theta_r : X_r \rightarrow K_{r+1}, \quad K_{r+1} = K(\pi_{r+1}(X_r), r + 1).$$

The space X_r is r -connected, $\pi_{r+1}(\theta_r)$ is the identity isomorphism and X_{r+1} is a cellular model for $X_r \times_{K_{r+1}} PK_{r+1}$. From θ_r we also obtain the morphism

$$\begin{array}{ccc} X_r \times_{K_{r+1}} PK_{r+1} & \xrightarrow{\tilde{\theta}_r} & PK_{r+1} \\ \rho_r \downarrow & & \downarrow \\ X_r & \xrightarrow{\theta_r} & K_{r+1} \end{array} \tag{9.5}$$

of ΩK_{r+1} -fibrations and, as in the proof of (8.8), sequences of isomorphisms

$$\pi_{r+1}(X_r) \xrightarrow{\cong} \pi_{r+1}(X_{r-1}) \xrightarrow{\cong} \cdots \xrightarrow{\cong} \pi_{r+1}(X).$$

Suppose $H_*(X, pt; \mathbb{Z})$ is \mathcal{P} -local. Then also $H_*(X_r, pt; \mathbb{Z})$ is \mathcal{P} -local for all r , by induction. Indeed if this holds for some r then $\pi_{r+1}(X_r)$ is \mathcal{P} -local and, by (9.4), $H_*(K_{r+1}; \mathbb{F}_p) = H_*(pt; \mathbb{F}_p)$, $p \notin \mathcal{P}$. Apply Theorem 8.5 to (9.5) to conclude that $H_*(\tilde{\theta}_r; \mathbb{F}_p)$ is an isomorphism, $p \notin \mathcal{P}$. Hence $H_*(X_{r+1}, pt; \mathbb{F}_p) = 0$, $p \notin \mathcal{P}$, and $H_*(X_{r+1}, pt; \mathbb{Z})$ is \mathcal{P} -local. In particular each $\pi_{r+1}(X_r)$ is \mathcal{P} -local and so $\pi_*(X)$ is \mathcal{P} -local.

Conversely if $\pi_*(X)$ is \mathcal{P} -local the homotopy group isomorphisms above imply that each $\pi_{r+1}(X_r)$ is \mathcal{P} -local. Hence, by Lemma 9.4, $H_*(\Omega K_{r+1}; \mathbb{F}_p) =$

$H_*(pt; \mathbb{F}_p)$ for $r \geq 0$ and $p \notin \mathcal{P}$. Regard

$$\begin{array}{ccc} X_r \times_{K_{r+1}} PK_{r+1} & \xrightarrow{id} & X_r \times_{K_{r+1}} PK_{r+1} \\ \downarrow id & & \downarrow \rho_r \\ X_r \times_{K_{r+1}} PK_{r+1} & \xrightarrow{\rho_r} & X_r \end{array}$$

as a morphism from an $\{e\}$ -fibration to an ΩK_{r+1} fibration. Conclude from Theorem 8.5 that $H_*(\rho_r; \mathbb{F}_p)$ is an isomorphism for $p \notin \mathcal{P}$. Since X_r is r -connected, the sequence of isomorphisms

$$\xrightarrow{\cong} H_*(X_{r+1}; \mathbb{F}_p) \xrightarrow{\cong} H_*(X_r; \mathbb{F}_p) \xrightarrow{\cong} \dots \xrightarrow{\cong} H_*(X; \mathbb{F}_p)$$

implies that $H_*(X; \mathbb{F}_p) = H_*(pt; \mathbb{F}_p)$, $p \notin \mathcal{P}$; i.e., $H_*(X, pt; \mathbb{Z})$ is \mathcal{P} -local.

This shows that (i) \iff (ii). Suppose (iii) holds. Let $j : \{x_0\} \rightarrow X$ be the inclusion of a basepoint and apply Theorem 8.5 to the map $Pj : P\{x_0\} \rightarrow PX$ of path space fibrations to conclude that $H_*(j; \mathbb{F}_p)$ is an isomorphism for $p \notin \mathcal{P}$. Thus (iii) \implies (ii).

Conversely, suppose (i) and (ii) hold. Recall from §2(c) that there is a fibration

$$X_1 \times_{K_2} PK_2 \rightarrow Y \xrightarrow{q} K_2$$

and a homotopy equivalence $Y \simeq X_1$ which identifies q with θ_1 . Since $X_1 \times_{K_2} PK_2$ is 2-connected and $\pi_i(X_1 \times_{K_2} PK_2) \cong \pi_i(X_1)$, $i \geq 3$ these groups are, in particular, \mathcal{P} -local and we may apply (i) \leftrightarrow (ii) to deduce that

$$H_*(\Omega(X_1 \times_{K_2} PK_2); \mathbb{F}_p) = H_*(pt; \mathbb{F}_p), \quad p \notin \mathcal{P}.$$

Now note that Ωq is an $\Omega(X_1 \times_{K_2} PK_2)$ -fibration. We shall apply Theorem 8.5 to

$$\begin{array}{ccc} \{pt\} & \xrightarrow{g} & \Omega Y \\ \downarrow & & \downarrow \Omega q \\ \{pt\} & \xrightarrow{f} & \Omega K_2. \end{array}$$

Lemma 9.4 asserts that $H_*(f; \mathbb{F}_p)$ is an isomorphism for $p \notin \mathcal{P}$. Hence so is $H_*(g; \mathbb{F}_p)$ and $H_*(\Omega X; \mathbb{F}_p) \cong H_*(\Omega X_1; \mathbb{F}_p) \cong H_*(\Omega Y; \mathbb{F}_p) \cong H_*(pt; \mathbb{F}_p)$, $p \notin \mathcal{P}$. \square

(b) Localization.

Suppose $\varphi : X \rightarrow Y$ is a continuous map between simply connected topological spaces, and that Y is \mathcal{P} -local. Then $\pi_*(Y)$ is a \mathbb{k} -module and $\pi_*(\varphi)$ extends uniquely to a morphism $\pi_*(X) \otimes_{\mathbb{Z}} \mathbb{k} \rightarrow \pi_*(Y)$.

Definition A \mathcal{P} -localization of a simply connected space X is a map $\varphi : X \rightarrow X_{\mathcal{P}}$ to a simply connected \mathcal{P} -local space $X_{\mathcal{P}}$ such that φ induces an isomorphism

$$\pi_*(X) \otimes_{\mathbb{Z}} \mathbb{k} \xrightarrow{\cong} \pi_*(X_{\mathcal{P}}).$$

When $\mathbb{k} = \mathbb{Q}$ this is called a *rationalization* and is denoted by $X \rightarrow X_{\mathbb{Q}}$.

Theorem 9.6 A continuous map $\varphi : X \rightarrow Y$ between simply connected spaces is a \mathcal{P} -localization if and only if Y is \mathcal{P} -local and $H_*(\varphi; \mathbb{k})$ is an isomorphism.

proof: Since Y is \mathcal{P} -local, $\pi_*(Y) = \pi_*(Y) \otimes_{\mathbb{Z}} \mathbb{k}$ and the homomorphism $\pi_*(X) \otimes_{\mathbb{Z}} \mathbb{k} \rightarrow \pi_*(Y)$ is just $\pi_*(\varphi) \otimes_{\mathbb{Z}} \mathbb{k}$. Thus Theorem 9.6 is a special case of the Whitehead-Serre Theorem 8.6. \square

Corollary The inclusion $S^n \rightarrow S_{\mathcal{P}}^n$ of the initial sphere in the telescope is a \mathcal{P} -localization. \square

Localizations always exist, and have important properties. We first describe this with a cellular construction that gives the true geometric flavour of the meaning of \mathcal{P} -localization.

Example *Cellular localization.*

Suppose (X, A) is a relative CW complex in which $X_1 = X_0 = A$ and A is a simply connected \mathcal{P} -local space. Thus the Cellular approximation theorem implies that X is simply connected. We shall use the natural inclusion $(D^{n+1}, S^n) \rightarrow (D_{\mathcal{P}}^{n+1}, S_{\mathcal{P}}^n)$ to construct a \mathcal{P} -localization of X of the form

$$\varphi : (X, A) \rightarrow (X_{\mathcal{P}}, A),$$

such that

- $(X_{\mathcal{P}}, A)$ is a relative $CW_{\mathcal{P}}$ complex.
- The \mathcal{P} -local n -cells of $(X_{\mathcal{P}}, A)$ are in 1-1 correspondence with the n -cells of (X, A) , $n \geq 2$.
- φ restricts to the identity in A , and to maps $\varphi_n : X_n \rightarrow (X_{\mathcal{P}})_{(n)}$ satisfying

$$\varphi_{n+1} = \varphi_n \cup \left(\coprod_{\alpha} \varphi_{\alpha} \right) : X_n \cup_{f_n} \left(\coprod_{\alpha} D_{\alpha}^{n+1} \right) \rightarrow (X_{\mathcal{P}})_{(n)} \cup_{g_n} \left(\coprod_{\alpha} D_{\mathcal{P}, \alpha}^{n+1} \right),$$

φ_{α} denoting the standard inclusion $D_{\alpha}^{n+1} \rightarrow D_{\mathcal{P}, \alpha}^{n+1}$.

- In particular, φ is the inclusion of a sub relative CW complex.

In fact, suppose inductively that $(X_{\mathcal{P}})_{(n)}$ and φ_n are constructed, and let $f_{\alpha} : S_{\alpha}^n \rightarrow X_n$ be the attaching map for some $(n+1)$ -cell of (X, A) . As noted in Remark 9.1, $(X_{\mathcal{P}})_{(n)}$ is \mathcal{P} -local; thus $\varphi_n f_{\alpha}$ represents an element in the \mathbb{k} -module $\pi_n((X_{\mathcal{P}})_{(n)})$.

We use this to extend $\varphi_n f_\alpha$ to a cellular map $g_\alpha : S_{\mathcal{P},\alpha}^n \rightarrow (X_{\mathcal{P}})_{(n)}$. Recall that $S_{\mathcal{P}}^n = \bigvee_{i=0}^{\infty} S_i^n \cup_h (\bigsqcup_{j=1}^{\infty} D_j^{n+1})$. Define $g_\alpha : \bigvee_{i=0}^{\infty} S_i^n \rightarrow (X_{\mathcal{P}})_{(n)}$ so that g_α restricts to $\varphi_n f_\alpha$ in S_0^n and restricts to a representative of $(\prod_{j=1}^r k_j)^{-1}[\varphi_n f_\alpha]$ in S_r^n , $r \geq 1$. (Here the k_j are the integers prime to \mathcal{P} used to define the telescope). Since h attaches D_r^{n+1} by a map representing $[S_{r-1}^n] - k_r[S_r^n]$, $g_\alpha h$ is homotopically constant and so g_α extends to all of $S_{\mathcal{P}}^n$. Use the Cellular approximation theorem 1.2 to replace g_α by a cellular map, homotopic rel S_0^n to the original.

Set $g_n = \bigsqcup_{\alpha} g_\alpha$. Define $(X_{\mathcal{P}})_{(n+1)} = (X_{\mathcal{P}})_{(n)} \cup_{g_n} (\bigsqcup_{\alpha} D_{\mathcal{P},\alpha}^{n+1})$ and define φ_{n+1} by the formula above. This completes the construction of $\varphi : (X, A) \rightarrow (X_{\mathcal{P}}, A)$. To see that φ is a \mathcal{P} -localization, it is enough to prove $H_*(\varphi; \mathbb{k})$ is an isomorphism (Theorem 9.6). This follows at once from the construction and the fact that the standard inclusions induce isomorphisms

$$H_*(D^{n+1}, S^n; \mathbb{k}) \xrightarrow{\cong} H_*(D_{\mathcal{P}}^{n+1}, S_{\mathcal{P}}^n; \mathbb{k}). \quad \square$$

Theorem 9.7

- (i) For each simply connected space X there is a relative CW complex $(X_{\mathcal{P}}, X)$ with no zero-cells and no one-cells such that the inclusion $\varphi : X \rightarrow X_{\mathcal{P}}$ is a \mathcal{P} -localization.
- (ii) If $(X_{\mathcal{P}}, X)$ is as in (i) then any continuous map f from X to a simply connected \mathcal{P} -local space Z extends to a map $g : X_{\mathcal{P}} \rightarrow Z$. If $g' : X_{\mathcal{P}} \rightarrow Z$ extends $f' : X \rightarrow Z$ then any homotopy from f to f' extends to a homotopy from g to g' .
- (iii) In particular, the \mathcal{P} -localizations of (i) are unique up to homotopy equivalence rel X .

proof: (i) Let $\psi : Y \rightarrow X$ be a weak homotopy equivalence from a CW complex Y such that $Y_1 = Y_0 = \{pt\}$. Let $j : Y \rightarrow Y_{\mathcal{P}}$ be a cellular \mathcal{P} -localization as described in the Example above. Put

$$X_{\mathcal{P}} = X \cup_{\psi} (Y \times I) \cup_j Y_{\mathcal{P}},$$

where we have identified $(y, 0)$ with $\psi(y)$ and $(y, 1)$ with $j(y)$. Then $(X_{\mathcal{P}}, X)$ is a relative CW complex with no zero- or one-cells. Since X is simply connected the Cellular approximation theorem implies that so is $X_{\mathcal{P}}$.

Next use excision and the fact that $H_*(\psi; \mathbb{Z})$ is an isomorphism to deduce

$$H_*(X_{\mathcal{P}}, Y_{\mathcal{P}}; \mathbb{Z}) \cong H_*(X \cup_{\psi} Y \times I, Y \times \{1\}; \mathbb{Z}) = 0.$$

Thus $H_*(X_{\mathcal{P}}, pt; \mathbb{Z}) \cong H_*(Y_{\mathcal{P}}, pt; \mathbb{Z})$. Since $Y_{\mathcal{P}}$ is \mathcal{P} -local so is $X_{\mathcal{P}}$.

Finally, since j is a \mathcal{P} -localization we may use excision to deduce that

$$H_*(X_{\mathcal{P}}, X; \mathbb{k}) \cong H_*(Y_{\mathcal{P}}, Y; \mathbb{k}) = 0.$$

Hence the inclusion $\varphi : X \rightarrow X_{\mathcal{P}}$ satisfies $H_*(\varphi; \mathbb{k})$ is an isomorphism; i.e., φ is a \mathcal{P} -localization.

(ii) Let $(Z \cup_f X_{\mathcal{P}}, Z)$ be the relative CW complex obtained by identifying $x \sim f(x), x \in X$. Since Z is \mathcal{P} -local the construction of the Example above gives a \mathcal{P} -localization

$$\sigma : (Z \cup_f X_{\mathcal{P}}, Z) \rightarrow ((Z \cup_f X_{\mathcal{P}})_{\mathcal{P}}, Z).$$

In particular, $H_*(\sigma, \mathbb{k})$ is an isomorphism.

On the other hand, $H_*(\varphi; \mathbb{k})$ is an isomorphism, and hence $H_*(Z \cup_f X_{\mathcal{P}}, Z; \mathbb{k}) \cong H_*(X_{\mathcal{P}}, X; \mathbb{k}) = 0$. Thus $H_*(Z, \mathbb{k}) \xrightarrow{\cong} H_*(Z \cup_f X_{\mathcal{P}}; \mathbb{k})$ and the composite inclusion $i : Z \rightarrow (Z \cup_f X_{\mathcal{P}})_{\mathcal{P}}$ also satisfies: $H_*(i; \mathbb{k})$ is an isomorphism. By the Whitehead-Serre theorem 8.6, $\pi_*(i) \otimes \mathbb{k}$ is an isomorphism. Since Z and $(Z \cup_f X_{\mathcal{P}})_{\mathcal{P}}$ are \mathcal{P} -local they satisfy $\pi_*(-) = \pi_*(-) \otimes \mathbb{k}$. Hence i is a weak homotopy equivalence.

Now the Whitehead lifting lemma 1.5 can be applied to

$$\begin{array}{ccc} Z & \xrightarrow{\quad} & Z \\ \downarrow & \cong & \downarrow i \\ Z \cup_f X_{\mathcal{P}} & \xrightarrow{\sigma} & (Z \cup_f X_{\mathcal{P}})_{\mathcal{P}} \end{array}$$

to obtain a retraction $r : Z \cup_f X_{\mathcal{P}} \rightarrow Z$. Define g to be the composite $X_{\mathcal{P}} \rightarrow Z \cup_f X_{\mathcal{P}} \xrightarrow{r} Z$.

Finally, suppose $g' : X_{\mathcal{P}} \rightarrow Z$ restricts to $f' : X \rightarrow Z$ and $\Phi : X \times I \rightarrow Z$ is a homotopy from f to f' . Consider the map

$$\psi = (g, \Phi, g') : (X_{\mathcal{P}} \times \{0\}) \cup X \times I \cup (X_{\mathcal{P}} \times \{1\}) \rightarrow Z.$$

An easy calculation like those above shows that the inclusion $(X_{\mathcal{P}} \times \{0\}) \cup X \times I \cup (X_{\mathcal{P}} \times \{1\}) \rightarrow X_{\mathcal{P}} \times I$ is a \mathcal{P} -localization. Hence ψ extends to a homotopy from g to g' . □

(c) Rational homotopy type.

We specialize now to the case $\mathbb{k} = \mathbb{Q}$ and $\mathcal{P} = \phi$. Consider a continuous map

$$f : X \rightarrow Y$$

between simply connected spaces. It follows from the Whitehead-Serre theorem 8.6 that the following conditions are equivalent:

- $\pi_*(f) \otimes \mathbb{Q}$ is an isomorphism.
- $H_*(f; \mathbb{Q})$ is an isomorphism.

- $H^*(f; \mathbb{Q})$ is an isomorphism.

In this case f is called a *rational homotopy equivalence*.

Theorem 9.8 implies that the rationalizations $X_{\mathbb{Q}}$ of a simply connected space all have the same weak homotopy type and that the weak homotopy type of $X_{\mathbb{Q}}$ depends only on the weak homotopy type of X .

Definition The weak homotopy type of $X_{\mathbb{Q}}$ is the *rational homotopy type* of X .

Theorem 9.7 also gives a second, equivalent description of rational homotopy type that does not explicitly involve rationalization.

Proposition 9.8 *Simply connected spaces X and Y have the same rational homotopy type if and only if there is a chain of rational homotopy equivalences*

$$X \longleftarrow Z(0) \longrightarrow \cdots \longleftarrow Z(k) \longrightarrow Y.$$

In particular if X and Y are CW complexes then they have the same rational homotopy type if and only if $X_{\mathbb{Q}} \simeq Y_{\mathbb{Q}}$.

proof: The first assertion is immediate from Theorem 9.7. The second follows immediately from the Whitehead lifting lemma 1.5, because $(X_{\mathbb{Q}}, X)$ and $(Y_{\mathbb{Q}}, Y)$ are relative CW complexes. □

Note: Rational homotopy theory is the study of properties of spaces and maps that depend *only* on rational homotopy type; i.e., are invariant under rational homotopy equivalence.

A *rational cellular model* for a simply connected space Y is a rational homotopy equivalence $\varphi : X \rightarrow Y$ from a CW complex X such that $X_1 = X_0 = \{pt\}$. We complete this section by observing, for simply connected spaces Y , that

- $H_*(Y; \mathbb{Q})$ has finite type $\Leftrightarrow Y$ is rationally modelled by a CW complex of finite type (9.9)
- $H_*(Y; \mathbb{Q})$ is finite dimensional and concentrated in degrees $\leq N$ $\Leftrightarrow Y$ is rationally modelled by a finite N -dimensional CW complex (9.10)

Both these observations are corollaries of

Theorem 9.11 *Every simply connected space Y is rationally modelled by a CW complex X for which the differential in the integral cellular chain complex is identically zero.*

Corollary $H_*(X; \mathbb{Z})$ is a free graded \mathbb{Z} -module.

proof of 9.11: With the aid of cellular models (Theorem 1.4) we reduce to the case Y is a CW complex, $Y_0 = Y_1 = \{pt\}$, and all cells are attached by based maps $(S^n, *) \rightarrow (Y_n, pt)$. Let (C_*, ∂) denote the cellular chain complex for Y and use the same symbol to denote an n -cell of Y and the corresponding basis element of C_n .

Choose n -cells a_i^n and b_j^n so that in the rational chain complex $(C_* \otimes \mathbb{Q}, \partial)$,

$$C_n \otimes \mathbb{Q} = (\ker \partial)_n \oplus \bigoplus_i \mathbb{Q}a_i^n = (Im \partial)_n \oplus \bigoplus_i \mathbb{Q}a_i^n \oplus \bigoplus_j \mathbb{Q}b_j^n.$$

Define subcomplexes $W(n) \subset Z(n) \subset Y_n$ by

$$W(n) = Y_{n-1} \cup \left(\bigcup_i a_i^n \right) \quad \text{and} \quad Z(n) = W(n) \cup \left(\bigcup_j b_j^n \right).$$

Since $\partial : \bigoplus_i \mathbb{Q}a_i^n \xrightarrow{\cong} (Im \partial)_{n-1}$ the Cellular chain models theorem 4.18 asserts that

$H_*(W(n), Z(n-1); \mathbb{Q}) = 0$. Thus the inclusion $\lambda : Z(n-1) \rightarrow W(n)$ gives an isomorphism of rational homology, and the Whitehead-Serre theorem 8.6 shows that $\pi_*(\lambda) \otimes \mathbb{Q}$ is an isomorphism. In particular, since the cells b_j^n are attached by maps $f_j : (S^{n-1}, *) \rightarrow Y_{n-1} \subset W(n)$, there are maps $g_j : (S^{n-1}, *) \rightarrow (Z(n-1), *)$ and non-zero integers r_j so that

$$\pi_{n-1}(\lambda)[g_j] = r_j[f_j].$$

We now construct $\varphi : X \rightarrow Y$ inductively so that φ restricts to rational homotopy equivalences $\varphi_n : X_n \rightarrow Z(n)$. Begin with $X_1 = X_0 = \{pt\}$ and $\varphi_1 : X_1 \rightarrow Y_1 = \{pt\}$. Suppose $\varphi_{n-1} : X_{n-1} \rightarrow Z(n-1)$ is constructed. Then there are maps $h_j : (S^{n-1}, *) \rightarrow (X_{n-1}, pt)$ and non-zero integers s_j such that $\pi_{n-1}(\varphi_{n-1})[h_j] = s_j[g_j]$. Set $h = \{h_j\} : \bigvee_j S_j^{n-1} \rightarrow X_{n-1}$, and set

$$X_n = X_{n-1} \cup_h \left(\bigvee_j D_j^n \right).$$

Choose maps $\theta_j : (S^{n-1}, *) \rightarrow (S^{n-1}, *)$ such that $[\theta_j] = s_j r_j [S^{n-1}]$ in $\pi_{n-1}(S^{n-1}, *)$. Thus in $\pi_{n-1}(W(n), *)$ we have

$$[f_j \theta_j] = \pi_{n-1}(f_j)[\theta_j] = s_j r_j \pi_{n-1}(f_j)[S^{n-1}] = s_j r_j [f_j].$$

It follows that $f_j \theta_j$ is based homotopic to $\varphi_{n-1} h_j$; i.e. there are maps

$$\Phi_j : S^{n-1} \times \left[\frac{1}{2}, 1 \right] \rightarrow W(n), \quad \text{with} \quad \begin{cases} \Phi(-, 1) = \varphi_{n-1} h_j \\ \Phi(-, \frac{1}{2}) = f_j \theta_j. \end{cases}$$

Then write

$$Z(n) = W(n) \cup_f \left(\bigvee_j D_j^n \right), \quad f = \{f_j\} : \bigvee_j S_j^{n-1} \rightarrow Y_{n-1},$$

and extend φ_{n-1} to φ_n by setting

$$\varphi_n(tv) = \begin{cases} \Phi_j(v, t) \in W(n), & v \in S_j^{n-1}, \frac{1}{2} \leq t \leq 1, \\ 2t\theta_j(v) \in D_j^n, & v \in S_j^{n-1}, 0 \leq t \leq \frac{1}{2}. \end{cases}$$

Put $X'_n = X_{n-1} \cup_h (\bigvee_j S_j^{n-1} \times [\frac{1}{2}, 1])$. Then (X_n, X'_n) is a relative CW complex whose cells are the disks $D_j^n(\frac{1}{2})$ of radius $\frac{1}{2}$. An immediate cellular chains argument (Theorem 4.18 and the following Remark) shows that φ_n induces a homology isomorphism $H_*(X_n, X'_n; \mathbb{Q}) \xrightarrow{\cong} H_*(Z(n), W(n); \mathbb{Q})$. But X_{n-1} is a deformation retract of X'_{n-1} , and the maps $\lambda : Z(n-1) \rightarrow W(n)$ and $\varphi_{n-1} : X_{n-1} \rightarrow Z(n-1)$ induce isomorphisms of rational homology. Hence

$$H_*(X'_n; \mathbb{Q}) \xrightarrow{\cong} H_*(W(n); \mathbb{Q}),$$

which gives

$$H_*(\varphi_n) : H_*(X_n; \mathbb{Q}) \xrightarrow{\cong} H_*(Z(n); \mathbb{Q})$$

as desired.

Finally, observe that for any n , $H_n(Z(n); \mathbb{Q}) \xrightarrow{\cong} H_n(Z(n), Z(n-1); \mathbb{Q})$, by an immediate cellular chains argument. Hence $H_n(X_n; \mathbb{Q}) \xrightarrow{\cong} H_n(X_n, X_{n-1}; \mathbb{Q})$. If (C^X, ∂) denotes the integral cellular chain complex for X then this implies that $(C_{\leq n}^X, \partial) \otimes \mathbb{Q} \rightarrow (C_n^X, 0) \otimes \mathbb{Q}$ yields an isomorphism of homology in degree n . This implies $\partial : C_n^X \rightarrow C_{n-1}^X$ is zero, again, for all n . \square

Exercises (All spaces are supposed 1-connected.)

1. Determine $X_{(p)}$ for $p = 2, 3$ or 0 and $X = S^n \cup_\varphi D^{n+1}$ with $\varphi : S^n \rightarrow S^n$ a continuous map of degree 6 (resp. 5). Same question with the fibre of the collapsing map $X \rightarrow S^{n+1}$.
2. A finite complex X is *universal* if for any rational equivalence $\alpha : A \rightarrow B$ and continuous map $f : X \rightarrow B$ there exists a rational equivalence $\beta : X \rightarrow A$ and a continuous map $g : X \rightarrow B$ such that $\alpha \circ g \simeq f \circ \beta$. Let X and Y be finite complexes and $f \in [X_{\mathbb{Q}}, Y_{\mathbb{Q}}]$. Prove that if X is universal then there exists $g \in [X, Y]$ and a rational equivalence $\alpha : X \rightarrow X$ such that $g_{\mathbb{Q}} \simeq f \circ \alpha_{\mathbb{Q}}$.
3. Let \mathcal{P} be a set of prime numbers, $\mathcal{P}' \subset \mathcal{P}$, and define the ring \mathbb{k}' by $\mathbb{k}' = \{m/k \mid k \text{ is relatively prime to the elements of } \mathcal{P}'\}$. Consider two localization maps $l : X \rightarrow X_{\mathcal{P}}$ and $l' : Y \rightarrow Y_{\mathcal{P}'}$ with $\mathcal{P}' \subset \mathcal{P}$. Prove that if $f : X \rightarrow Y$ is a continuous map then there exists a map $f_{l,l'} : X_{\mathcal{P}} \rightarrow Y_{\mathcal{P}'}$, unique up to homotopy, such that $f_{l,l'} \circ l = l' \circ f$ and the following diagrams commute:

$$\begin{array}{ccc}
 \pi_n(X) \otimes Ik' & \xrightarrow{\pi_n f \otimes id} & \pi_n(Y) \otimes Ik' \\
 \cong \downarrow & & \downarrow \cong \\
 \pi_n(X_{\mathcal{P}}) \otimes Ik' & \xrightarrow{\pi_n f_{i,l'}} & \pi_n(Y_{\mathcal{P}'})
 \end{array}
 \qquad
 \begin{array}{ccc}
 H_n(X) \otimes Ik' & \xrightarrow{H_n f \otimes id} & H_n(Y) \otimes Ik' \\
 \cong \downarrow & & \downarrow \cong \\
 H_n(X_{\mathcal{P}}; Ik') & \xrightarrow{H_n f_{i,l'}} & H_n(Y_{\mathcal{P}'})
 \end{array}$$

4. Let \mathcal{P} be a set of prime numbers and the ring Ik be as defined at the beginning of this section. A continuous map $f : X \rightarrow Y$ is a \mathcal{P} -equivalence if for any $n \geq 2$, $\pi_n(X) \otimes Ik \xrightarrow{\pi_n f \otimes id} \pi_n(Y) \otimes Ik$ is an isomorphism. Prove that f is a \mathcal{P} -equivalence if and only if $f_{\mathcal{P}}$ is a homotopy equivalence. When Y is supposed 2-connected, prove that this is also equivalent to the following assertion : $\Omega f : \Omega X \rightarrow \Omega Y$ is a \mathcal{P} -equivalence. **Remark:** *It is not true that the existence of a p -equivalence $f : X \rightarrow Y$ for every prime p implies that $X \simeq Y$. This motivates the introduction of the genus of a space X , i.e. the set of $[Y]$ such that for any prime p , $Y_p \simeq X_p$.*

5. Let $f : X \rightarrow Y$ be a rational homotopy equivalence between finite CW complexes and \mathcal{P} be the set of all primes. Prove that there exist $p_1, p_2, \dots, p_k \in \mathcal{P}$ such that $X_P \simeq Y_P$ where $P = \mathcal{P} - \{p_1, p_2, \dots, p_k\}$.

Part II

Sullivan Models

10 Commutative cochain algebras for spaces and simplicial sets

In this section the ground ring is a field \mathbb{k} of characteristic zero.

Recall from §5 that $C^*(X; \mathbb{k})$ denotes the cochain algebra of normalized singular cochains on a topological space X . This algebra is almost never commutative, although it is homotopy commutative.

Now however, *because \mathbb{k} is a field of characteristic zero*, it turns out that we may replace $C^*(X; \mathbb{k})$ by a genuinely commutative cochain algebra. More precisely, we introduce a naturally defined commutative cochain algebra $A_{PL}(X; \mathbb{k})$, and natural cochain algebra quasi-isomorphisms

$$C^*(X; \mathbb{k}) \xrightarrow{\cong} D(X) \xleftarrow{\cong} A_{PL}(X; \mathbb{k}),$$

where $D(X)$ is a third natural cochain algebra. The construction of $A_{PL}(X; \mathbb{k})$, due to Sullivan [144], is inspired from C^∞ differential forms, while reflecting the combinatorial nature of how the singular simplices of X fit together. The functor

$$X \rightsquigarrow A_{PL}(X; \mathbb{k})$$

serves as the fundamental bridge which we use to transfer problems from topology to algebra. It is important to note that *this functor is contravariant; i.e., it reverses arrows.*

The quasi-isomorphisms above will be constructed in Theorem 10.9. They define a natural isomorphism of graded algebras,

$$H^*(X; \mathbb{k}) = H(A_{PL}(X; \mathbb{k})), \tag{10.1}$$

and we shall always identify these two algebras via this particular isomorphism. Thus for any continuous map, f , we identify $H^(f; \mathbb{k}) = H(A_{PL}(f; \mathbb{k}))$.*

Recall now from Proposition 9.8 that two simply connected spaces X and Y have the *same rational homotopy type* if and only if there is a chain of rational homotopy equivalences

$$X \longleftarrow Z(0) \longrightarrow \cdots \longleftarrow Z(k) \longrightarrow Y.$$

There is an analogous notion for commutative cochain algebras: two commutative cochain algebras (A, d) and (B, d) are *weakly equivalent* if they are connected by a chain

$$(A, d) \xrightarrow{\cong} (C(0), d) \xleftarrow{\cong} \cdots \xrightarrow{\cong} (C(k), d) \xleftarrow{\cong} (B, d)$$

of quasi-isomorphisms of *commutative* cochain algebras. Such a chain is called a *weak equivalence between (A, d) and (B, d) .*

Next recall from §9(c) that a continuous map $f : X \rightarrow Y$ between simply connected spaces is a rational equivalence if and only if $H^*(f; \mathbb{Q})$ is an isomorphism. Since \mathbb{k} is a field of characteristic zero and we identify $H(A_{PL}(f; \mathbb{k}))$

with $H^*(f; \mathbb{k})$ it follows that f is a rational equivalence if and only if $A_{PL}(f; \mathbb{k})$ is a quasi-isomorphism.

In particular if X and Y have the same rational homotopy type then $A_{PL}(X; \mathbb{k})$ and $A_{PL}(Y; \mathbb{k})$ are weakly equivalent, and so $A_{PL}(-; \mathbb{k})$ defines a map

$$\left\{ \begin{array}{c} \text{rational homotopy} \\ \text{types} \end{array} \right\} \rightarrow \left\{ \begin{array}{c} \text{weak equivalence classes of} \\ \text{commutative cochain algebras.} \end{array} \right\}$$

In §17 we show that if $\mathbb{k} = \mathbb{Q}$ and if we restrict to simply connected spaces X and commutative cochain algebras (A, d) such that $H^*(X; \mathbb{Q})$ and $H(A, d)$ have finite type, then *this correspondence is a bijection*. This fundamental result of Quillen-Sullivan reduces rational homotopy theory to the study of commutative cochain algebras. As noted in the Introduction, our purpose in this text is to show how this result may be *applied* to extract topological information from the algebra.

Since homotopy information is carried by the weak equivalence class of $A_{PL}(X; \mathbb{k})$ we may (and frequently will) replace it by a simpler, weakly equivalent, commutative cochain algebra: such a cochain algebra will be called a *commutative model* for X . More formally we make the

Definition: A *commutative cochain algebra model* for a space X (or simply a *commutative model for X*) is a commutative cochain algebra (A, d) together with a weak equivalence

$$(A, d) \xrightarrow{\cong} \cdots \xleftarrow{\cong} A_{PL}(X; \mathbb{k}).$$

Henceforth we shall fix \mathbb{k} and, for the sake of simplicity suppress \mathbb{k} from the notation, writing $A_{PL}(-)$ for $A_{PL}(-; \mathbb{k})$ and $C^*(-)$ for $C^*(-; \mathbb{k})$. The rest of this section is spent on constructing $A_{PL}(X)$ and establishing its relation to $C^*(X)$. The section covers six topics:

- (a) Simplicial sets and simplicial cochain algebras.
 - (b) The construction $A(K)$.
 - (c) The simplicial commutative cochain algebra A_{PL} , and $A_{PL}(X)$.
 - (d) The simplicial cochain algebra C_{PL} , and the main theorem.
 - (e) Integration and the de Rham theorem.
- (a) **Simplicial sets and simplicial cochain algebras.**

A *simplicial object K with values in a category \mathcal{C}* is a sequence $\{K_n\}_{n \geq 0}$ objects in \mathcal{C} , together with \mathcal{C} -morphisms

$$s_j : K_n \rightarrow K_{n+1}, \quad 0 \leq j \leq n.$$

satisfying the identities

$$\begin{aligned}
 \partial_i \partial_j &= \partial_{j-1} \partial_i & , i < j; \\
 s_i s_j &= s_{j+1} s_i & , i \leq j; \\
 \partial_i s_j &= \begin{cases} s_{j-1} \partial_i & , i < j \\ id & , i = j, j + 1 \\ s_j \partial_{i-1} & , i > j + 1. \end{cases} & (10.2)
 \end{aligned}$$

A *simplicial morphism* $f : L \rightarrow K$ between two such simplicial objects is a sequence of \mathcal{C} -morphisms $\varphi_n : L_n \rightarrow K_n$ commuting with the ∂_i and s_j .

A *simplicial set* K is a simplicial object in the category of sets. Thus it consists of a sequence of sets $\{K_n\}_{n \geq 0}$ together with set maps ∂_i, s_j satisfying the relations (10.2). The motivating example is, of course, the simplicial set $S_*(X) = \{S_n(X)\}_{n \geq 0}$ of singular simplices $\sigma : \Delta^n \rightarrow X$ on a topological space X , with face and degeneracy maps are defined in §4(a). This is a functor, with a continuous map f inducing the morphism $S_*(f) : \sigma \mapsto f \circ \sigma, \sigma \in S_n(X)$.

A *simplicial cochain algebra* A is a simplicial object in the category of cochain algebras: it consists of a sequence of cochain algebras $\{A_n\}_{n \geq 0}$ with appropriate face and degeneracy morphisms. Similarly *simplicial cochain complexes, simplicial vector spaces ...* are simplicial objects in the category of cochain complexes, vector spaces, Thus a morphism of simplicial cochain complexes, $\theta : D \rightarrow E$, is a sequence $\theta_n : D_n \rightarrow E_n$ of morphisms of cochain complexes, compatible with the face and degeneracy maps. If each θ_n is a quasi-isomorphism we call θ a *quasi-isomorphism of simplicial cochain algebras*.

Let K be any simplicial set. By analogy with $S_*(X)$ the elements $\sigma \in K_n$ are called *n-simplices* and σ is *non-degenerate* if it is *not* of the form $\sigma = s_j \tau$ for some j and some $\tau \in K_{n-1}$. The subset of non-degenerate n -simplices is denoted by NK_n . It follows from the relations (10.2) that for each $k \geq 0$ a subsimplicial set $K(k) \subset K$ is given as follows: for $n \leq k, K(k)_n = K_n$ and for $n > k, K(k)_n = \{s_j \tau \mid 0 \leq j \leq n-1, \tau \in K(k)_{n-1}\}$. The simplicial set $K(k)$ is called the *k-skeleton* of K , and is characterized by

$$N(K(k)_n) = \begin{cases} NK_n & , n \leq k \\ \phi & , n > k. \end{cases}$$

The *dimension* of K is the greatest k (or ∞) such that $NK_k \neq \phi$, and this is also the least k such that $K(k) = K$.

Finally, we use the notation of §4(a) to introduce a sequence of important subsimplicial sets $\Delta[n] \subset S_*(\Delta^n), n \geq 0$. Let e_0, \dots, e_n be the vertices of Δ^n . Then $\Delta[n]_k \subset S_k(\Delta^n)$ consists of the linear k -simplices of the form $\sigma = \langle e_{i_0} \cdots e_{i_k} \rangle$ with $0 \leq i_0 \leq \cdots \leq i_k \leq n$. Thus σ is non-degenerate if and only if $i_0 < \cdots < i_k$. In particular $\Delta[k]$ is k -dimensional and the identity map

$$c_n = \langle e_0 \cdots e_n \rangle : \Delta^n \rightarrow \Delta^n$$

is the unique non-degenerate n -simplex; c_n is called the *fundamental simplex* of

$\Delta[n]$. The $(n-1)$ -skeleton of $\Delta[n]$ is denoted by $\partial\Delta[n]$ and is called the *boundary* of $\Delta[n]$.

Lemma 10.3 *If K is any simplicial set then any $\sigma \in K_n$ determines a unique simplicial set map $\sigma_* : \Delta[n] \rightarrow K$ such that $\sigma_*(c_n) = \sigma$.*

proof: The verification using (10.2) is straightforward, but the reader may also refer to [122]. \square

A simplicial object A in a category \mathcal{C} is called *extendable* if for any $n \geq 1$ and any $\mathcal{I} \subset \{0, \dots, n\}$, the following condition holds: given $\Phi_i \in A_{n-1}, i \in \mathcal{I}$, and satisfying

$$\partial_i \Phi_j = \partial_{j-1} \Phi_i \quad , i < j,$$

there exists an element $\Phi \in A_n$ such that $\Phi_i = \partial_i \Phi, i \in \mathcal{I}$.

(b) **The construction $A(K)$.**

Let K be a simplicial set, and let $A = \{A_n\}_{n \geq 0}$ be a simplicial cochain complex or a simplicial cochain algebra. Then

$$A(K) = \{A^p(K)\}_{p \geq 0}$$

is the “ordinary” cochain complex (or cochain algebra) defined as follows:

- $A^p(K)$ is the set of simplicial set morphisms from K to A^p .

Thus an element $\Phi \in A^p(K)$ is a mapping that assigns to each n -simplex $\sigma \in K_n$ ($n \geq 0$) an element $\Phi_\sigma \in (A^p)_n$, such that $\Phi_{\partial_i \sigma} = \partial_i \Phi_\sigma$ and $\Phi_{s_j \sigma} = s_j \Phi_\sigma$.

- Addition, scalar multiplication and the differential are given by

$$(\Phi + \Psi)_\sigma = \Phi_\sigma + \Psi_\sigma, \quad (\lambda \cdot \Psi)_\sigma = \lambda \cdot \Psi_\sigma \quad \text{and} \quad (d\Psi)_\sigma = d(\Psi_\sigma).$$

- If A is a simplicial cochain algebra multiplication in $A(K)$ is given by

$$(\Phi \cdot \Psi)_\sigma = \Phi_\sigma \cdot \Psi_\sigma.$$

- If $\varphi : K \rightarrow L$ is a morphism of simplicial sets then $A(\varphi) : A(K) \leftarrow A(L)$ is the morphism of cochain complexes (or cochain algebras) defined by

$$(A(\varphi)\Phi)_\sigma = \Phi_{\varphi\sigma}.$$

- If $\theta : A \rightarrow B$ is a morphism of simplicial cochain complexes (or simplicial cochain algebras) then $\theta(K) : A(K) \rightarrow B(K)$ is the morphism defined by

$$(\theta(K)\Phi)_\sigma = \theta(\Phi_\sigma).$$

- When X is a topological space we write $A(X)$ for $A(S_*(X))$.
- If $\sigma \in K_n$ then $\Phi \mapsto \Phi_\sigma$ defines a morphism $A(K) \rightarrow A_n$ called *restriction to σ* .

Remark Note that the construction $A(K)$ is functorial in A and contrafunctorial in K .

Proposition 10.4 *Let A be a simplicial cochain algebra.*

- (i) *For $n \geq 0$ an isomorphism $A(\Delta[n]) \xrightarrow{\cong} A_n$ of cochain algebras is given by $\Phi \mapsto \Phi_{c_n}$, where c_n is the fundamental simplex of $\Delta[n]$.*
- (ii) *If A is extendable and $L \subset K$ is an inclusion of simplicial sets, then $A(K) \rightarrow A(L)$ is surjective.*

proof: (i) The definitions show that $\Phi \mapsto \Phi_{c_n}$ is a morphism of cochain algebras. Since $A^p(\Delta[n])$ consists of the simplicial set maps $\Delta[n] \rightarrow A^p$, Lemma 10.3 asserts that this morphism is a bijection.

(ii) Given $\Psi \in A(L)$ we give an inductive procedure for constructing $\Phi \in A(K)$ that restricts to Ψ . In fact, suppose we have found elements Φ_σ , $\sigma \in K_k$, $k < n$ such that

$$\Phi_\sigma = \Psi_\sigma, \sigma \in L_k; \quad \Phi_{\partial_i \sigma} = \partial_i \Phi_\sigma; \quad \Phi_{s_j \tau} = s_j \Phi_\tau, \tau \in K_m, m < n - 1.$$

Then define $\Phi_\sigma, \sigma \in K_n$ as follows.

If $\sigma \in L_n$, $\Phi_\sigma = \Psi_\sigma$. If σ has the form $s_j \tau$, $\tau \in K_{n-1}$, use (10.2) to see that $s_j \Phi_\tau$ is independent of the choice of j and τ and put $\Phi_\sigma = s_j \Phi_\tau$. Finally, if $\sigma \in K_n - L_n$ is non-degenerate note that $\partial_i(\Phi_{\partial_j \sigma}) = \partial_{j-1}(\Phi_{\partial_i \sigma}), i < j$. Since A is extendable we may therefore choose Φ_σ so that $\partial_i \Phi_\sigma = \Phi_{\partial_i \sigma}, 0 \leq i \leq n$. In all cases the equations above will be satisfied, as follows easily from (10.2). \square

If A is an extendable simplicial cochain algebra and $L \subset K$ is an inclusion of simplicial sets we denote by $A(K, L)$ the kernel of the surjective morphism $A(K) \rightarrow A(L)$.

Thus $A(K, L)$ is a differential ideal in $A(K)$ and

$$0 \rightarrow A(K, L) \rightarrow A(K) \rightarrow A(L) \rightarrow 0$$

is a short exact sequence of cochain complexes, natural with respect to (K, L) and with respect to the simplicial cochain algebra A .

A key step in the proof of Theorem 10.9 is the following

Proposition 10.5 *Suppose $\theta : D \rightarrow E$ is a morphism of simplicial cochain complexes. Assume that*

- (i) $H(\theta_n) : H(D_n) \rightarrow H(E_n)$ is an isomorphism, $n \geq 0$.
- (ii) D and E are extendable.

Then for all simplicial sets K ,

$$H(\theta(K)) : H(D(K)) \rightarrow H(E(K))$$

is an isomorphism.

First we establish a preliminary lemma. Define

$$\alpha : A(K(n), K(n-1)) \longrightarrow \prod_{\sigma \in NK_n} A(\Delta[n], \Delta[n-1]) \quad , n \geq 0,$$

by setting $\alpha : \Phi \mapsto \{A(\sigma_*)\Phi\}_{\sigma \in NK_n}$, where $\sigma_* : \Delta[n] \rightarrow K$ is the unique simplicial map (Lemma 10.3) such that $\sigma_*(c_n) = \sigma$.

Lemma 10.6 *If K is a simplicial set and A is an extendable simplicial cochain complex then α is an isomorphism, natural in A and in K .*

proof: If $\alpha(\Phi) = 0$ then Φ vanishes on all the non-degenerate simplices of $K(n)$ and hence $\Phi = 0$. Conversely, given a family $\{\Psi_\sigma \in A(\Delta[n], \Delta[n-1])\}_{\sigma \in NK_n}$, we recall first that (Proposition 10.4 (i))

$$A(\Delta[n], \Delta[n-1]) \subset A(\Delta[n]) = A_n.$$

This identifies the Ψ_σ as elements of A_n satisfying $\partial_i \Psi_\sigma = 0$, $0 \leq i \leq n$. Define $\Phi \in A(K(n), K(n-1))$ by the three conditions:

$$\begin{cases} \Phi_\sigma &= 0 & , \sigma \in K_m, m < n \\ \Phi_\sigma &= \Psi_\sigma & , \sigma \in NK_n \\ \Phi_{s_j \sigma} &= s_j \Phi_\sigma & , \text{all } j, \sigma. \end{cases}$$

Clearly $\alpha\Phi = \{\Psi_\sigma\}$. □

proof of 10.5: For any inclusion $L \subset M$ of simplicial sets we have the row exact (Proposition 10.4 (ii)) commutative diagram

$$\begin{array}{ccccccc} 0 & \longrightarrow & D(M, L) & \longrightarrow & D(M) & \longrightarrow & D(L) \longrightarrow 0 \\ & & \theta(M, L) \downarrow & & \downarrow \theta(M) & & \downarrow \theta(L) \\ 0 & \longrightarrow & E(M, L) & \longrightarrow & E(M) & \longrightarrow & E(L) \longrightarrow 0 \end{array}$$

Hence, if any two of the vertical arrows is a quasi-isomorphism, so is the third. Moreover Proposition 10.4 (i), identifies $\theta(\Delta[n]) : D(\Delta[n]) \rightarrow E(\Delta[n])$ with $\theta_n : D_n \rightarrow E_n$. Hence $\theta(\Delta[n])$ is a quasi-isomorphism, $n \geq 0$. We now use induction on n to show that for any simplicial set K , $\theta(K(n))$ is a quasi-isomorphism.

Indeed, this is vacuous for $n = -1$. Suppose it holds for some $n - 1$. From Lemma 10.6 and the remarks above it follows that $\theta(-)$ is a quasi-isomorphism when $(-)$ is in turn given by:

$$\partial\Delta[n], \quad (\Delta[n], \partial\Delta[n]), \quad (K(n), K(n - 1)) \text{ and } K(n).$$

This completes the inductive step. Along the way we have also shown that each $\theta(K(n), K(n - 1))$ is a quasi-isomorphism.

Finally, let K be any simplicial set. Given $\Phi \in D(K)$ and $\Psi \in E(K)$ such that $d\Phi = 0$ and $\theta(K)\Phi = d\Psi$, we shall find $\Omega \in D(K)$ and $\Gamma \in E(K)$ such that $\Phi = d\Omega$ and $\Psi = \theta(K)\Omega + d\Gamma$. This implies at once that $\theta(K)$ is a quasi-isomorphism (Lemma 3.2).

To find Ω and Γ we construct inductively a sequence $\Omega_n \in D(K, K(n - 1))$ and $\Gamma_n \in E(K, K(n - 1))$ such that

$$\Phi - \sum_{i \leq n} d\Omega_i \in D(K, K(n))$$

and

$$\Psi - \sum_{i \leq n} (\theta(K)\Omega_i + d\Gamma_i) \in E(K, K(n)).$$

Indeed, set $\Omega_{-1} = \Gamma_{-1} = 0$. If Ω_i and Γ_i are constructed for $i < n$, set $\Phi' = \Phi - \sum_{i < n} d\Omega_i$ and $\Psi' = \Psi - \sum_{i < n} (\theta(K)\Omega_i + d\Gamma_i)$. Then Φ' restricts to $\Phi'' \in D(K(n), K(n - 1))$, Ψ' restricts to $\Psi'' \in E(K(n), K(n - 1))$, $d\Phi'' = 0$ and $\theta(K)\Phi'' = d\Psi''$. Our remarks above show that $\theta(K(n), K(n - 1))$ is a quasi-isomorphism. Hence we can find $\Omega'' \in D(K(n), K(n - 1))$ and $\Gamma'' \in E(K(n), K(n - 1))$ such that $\Phi'' = d\Omega''$ and $\Psi'' = \theta(K)\Omega'' + d\Gamma''$. Now close the induction by using the extendability of D and E to find $\Omega_n \in D(K, K(n - 1))$ and $\Gamma_n \in E(K, K(n - 1))$ which restrict respectively to Ω'' and Γ'' .

Finally, the sequence $\{\Omega_n\}$ satisfies $(\Omega_n)_\sigma = 0$, $n > \dim \sigma$. Thus we may define $\Omega \in D(K)$ and $\Gamma \in E(K)$ by $\Omega_\sigma = \sum_n (\Omega_n)_\sigma$ and $\Gamma_\sigma = \sum_n (\Gamma_n)_\sigma$. Clearly

$$\Phi = d\Omega \quad \text{and} \quad \Psi = \theta(K)\Omega + d\Gamma.$$

□

(c) **The simplicial commutative cochain algebra A_{PL} , and $A_{PL}(X)$.**

The first step in constructing a functor from topological spaces to commutative cochain algebras is the construction of the simplicial commutative cochain algebra, A_{PL} .

For this consider the free graded commutative algebra $\Lambda(t_0, \dots, t_n, y_0, \dots, y_n)$ -cf. §3, Example 6.- in which the basis elements t_i have degree zero and the

basis elements y_j have degree 1. Thus this algebra is the tensor product of the polynomial algebra in the variables t_i with the exterior algebra in the variables y_j . A unique derivation in this algebra is specified by $t_i \mapsto y_i$ and $y_j \mapsto 0$. It preserves the ideal I_n generated by the two elements $\sum_0^n t_i - 1$ and $\sum_0^n y_j$.

Now define $A_{PL} = \{(A_{PL})_n\}_{n \geq 0}$ by:

- The cochain algebra $(A_{PL})_n$ is given by

$$(A_{PL})_n = \frac{\Lambda(t_0, \dots, t_n, y_0, \dots, y_n)}{(\sum t_i - 1, \sum y_j)};$$

$$dt_i = y_i \quad \text{and} \quad dy_j = 0.$$

- The face and degeneracy morphisms are the unique cochain algebra morphisms

$$\partial_i : (A_{PL})_{n+1} \rightarrow (A_{PL})_n \quad \text{and} \quad s_j : (A_{PL})_n \rightarrow (A_{PL})_{n+1}$$

satisfying

$$\partial_i : t_k \mapsto \begin{cases} t_k & , k < i \\ 0 & , k = i \\ t_{k-1} & , k > i \end{cases} \quad \text{and} \quad s_j : t_k \mapsto \begin{cases} t_k & , k < j \\ t_k + t_{k+1} & , k = j \\ t_{k+1} & , k > j. \end{cases}$$

Notice that the inclusions $t_i \rightarrow (A_{PL})_n, y_j \rightarrow (A_{PL})_n$ extend to an isomorphism of cochain algebras,

$$(\Lambda(t_1, \dots, t_n, y_1, \dots, y_n), d) \xrightarrow{\cong} (A_{PL})_n.$$

Remark 1 The elements of $(A_{PL})_n$ are called *polynomial differential forms with coefficients in \mathbb{k}* , for the following reason. When $\mathbb{k} \subset \mathbb{R}$ (e.g. $\mathbb{k} = \mathbb{Q}$) the algebra

$$(A_{PL})_n^0 = \mathbb{k}[t_0, \dots, t_n] / (\sum t_i - 1)$$

is the \mathbb{k} - (eg. rational) subalgebra of the smooth functions $C^\infty(\Delta^n)$ generated by the restrictions t_i of the coordinate functions of \mathbb{R}^{n+1} . This identifies $(A_{PL})_n$ as a sub-cochain algebra of the classical cochain algebra, $A_{DR}(\Delta^n)$ of real C^∞ differential forms on Δ^n ; moreover, $A_{DR}(\Delta^n) = C^\infty(\Delta^n) \otimes_{(A_{PL})_n^0} (A_{PL})_n$.

Note that this also identifies

$$\partial_i = A_{DR}(\lambda_i) \quad \text{and} \quad s_j = A_{DR}(\varrho_j),$$

where the λ_i are the face inclusions and the ϱ_j are the degeneracies for the simplices Δ^n as defined in §4(a). These ideas will be further developed in §11.

Remark 2 Each $A_{PL}^p, p \geq 0$, is itself a simplicial vector space and $A_{PL} = \{A_{PL}^p\}_{p \geq 0}$, equipped with the obvious simplicial multiplication and differential.

Lemma 10.7

- (i) $(A_{PL})_0 = \mathbb{k} \cdot 1$.
- (ii) $H((A_{PL})_n) = \mathbb{k} \cdot 1, n \geq 0$.
- (iii) Each A_{PL}^p is extendable.

proof: (i) This is immediate from the definition.

(ii) The isomorphism above identifies $(A_{PL})_n$ as the tensor product $\bigotimes_{i=1}^n \Lambda(t_i, y_i)$. Since $d(t_i^k) = kt_i^{k-1}y_i$ it follows that $H(\Lambda(t_i, y_i)) = \mathbb{k} \cdot 1$. But $H(-)$ commutes with tensor products (Proposition 3.3) and so $H((A_{PL})_n) = \mathbb{k} \cdot 1$ as well.

(iii) Suppose given $\mathcal{I} \subset \{0, \dots, n\}$ and elements $\Phi_i \in (A_{PL})_{n-1}, i \in \mathcal{I}$, satisfying $\partial_i \Phi_j = \partial_{j-1} \Phi_i, i < j$. Beginning with $\Psi_{-1} = 0$, we inductively construct elements $\Psi_r \in (A_{PL})_n, -1 \leq r \leq n$, such that:

$$\partial_i \Psi_r = \Phi_i, \quad \text{if } i \in \mathcal{I} \text{ and } i \leq r.$$

We may suppose Ψ_{r-1} constructed. If $r \notin \mathcal{I}$ set $\Psi_r = \Psi_{r-1}$; otherwise proceed as follows. Embed the polynomial algebra $(A_{PL}^0)_n$ in its field of fractions F and let $B^0 \subset F$ be the subalgebra generated by $(A_{PL}^0)_n$ and the element $\frac{1}{1-t_r}$. Setting $d\left(\frac{1}{1-t_r}\right) = \frac{dt_r}{(1-t_r)^2}$ defines a cochain algebra

$$B = B^0 \otimes_{(A_{PL}^0)_n} (A_{PL})_n = B^0 \otimes \Lambda(dt_1, \dots, dt_n)$$

which contains $(A_{PL})_n$. Moreover a morphism $\varphi : (A_{PL})_{n-1} \rightarrow B$ of cochain algebras is given by

$$\varphi(t_i) = \begin{cases} \frac{t_i}{1-t_r}, & i < r \\ \frac{t_{i+1}}{1-t_r}, & i \geq r \end{cases} \quad \text{and} \quad \varphi(dt_i) = d\varphi(t_i).$$

On the other hand, we may extend ∂_r to a morphism $B \rightarrow (A_{PL})_{n-1}$ by setting $\partial_r\left(\frac{1}{1-t_r}\right) = 1$. Clearly $\partial_r \circ \varphi = id$.

Every element of B has the form $\frac{1}{(1-t_r)^N} \Psi$ for some $N \geq 0$ and some $\Psi \in (A_{PL})_n$. In particular we may write

$$(1-t_r)^N \varphi(\Phi_r - \partial_r \Psi_{r-1}) = \Psi, \quad \text{some } \Psi \in (A_{PL})_n.$$

Now, for $i \in \mathcal{I}$ and $i < r$, we have

$$\partial_i(\Phi_r - \partial_r \Psi_{r-1}) = \partial_{r-1}(\Phi_i - \partial_i \Psi_{r-1}) = 0.$$

Hence $\Phi_r - \partial_r \Psi_{r-1}$ is in the ideal generated by t_i and dt_i in $(A_{PL})_{n-1}$, and it follows that Ψ is in the ideal generated by t_i and dt_i in $(A_{PL})_n$. In particular, $\partial_i \Psi = 0$, $i \in \mathcal{I}$ and $i < r$.

On the other hand, since $\partial_r \varphi = id$, we also have $\partial_r \Psi = \Phi_r - \partial_r \Psi_{r-1}$. Thus $\partial_j(\Psi + \Psi_{r-1}) = \Phi_j$ for $j \in \mathcal{I}$ and $j \leq r$. This closes the induction. \square

Because the graded algebras $(A_{PL})_n$ are *commutative*, the construction $A_{PL}(\)$ defined in (b) assigns to each simplicial set K a *commutative* cochain algebra, $A_{PL}(K)$, and to each map f of simplicial sets a morphism, $A_{PL}(f)$ of commutative cochain algebras. Since A_{PL} is extendable, with every pair $L \subset K$ of simplicial sets is associated the short exact sequence

$$0 \rightarrow A_{PL}(K, L) \rightarrow A_{PL}(K) \rightarrow A_{PL}(L) \rightarrow 0.$$

For topological spaces X and continuous maps f we apply this construction to the simplicial set $S_*(X)$ and to $S_*(f)$. This defines a contravariant functor from spaces to commutative cochain algebras, which will be denoted

$$X \rightsquigarrow A_{PL}(X) \quad \text{and} \quad f \rightsquigarrow A_{PL}(f).$$

In particular, associated with a subspace Y is the short exact sequence

$$0 \rightarrow A_{PL}(X, Y) \rightarrow A_{PL}(X) \rightarrow A_{PL}(Y) \rightarrow 0.$$

When it is necessary to indicate the coefficient field explicitly we shall write $A_{PL}(X; \mathbb{k})$, $A_{PL}(K; \mathbb{k})$ and $A_{PL}(f; \mathbb{k})$ for $A_{PL}(X)$, $A_{PL}(K)$ and $A_{PL}(f)$.

An element of $A_{PL}^p(X)$ is a function assigning to each singular n -simplex of X a polynomial p -form on Δ^n , $n \geq 0$, compatible with the face and degeneracy maps. This motivates the following terminology: The commutative cochain algebra, $A_{PL}(X)$, is the cochain algebra of *polynomial differential forms on X with coefficients in \mathbb{k}* .

Example 1 When $X = \{pt\}$, then $S_*(X) = \Delta[0]$. It follows that $A_{PL}(X) = (A_{PL})_0 = \mathbb{k}$;

$$A_{PL}(pt) = \mathbb{k}.$$

Thus an inclusion $j : pt \rightarrow Y$ induces an augmentation $\varepsilon = A_{PL}(j) : A_{PL}(Y) \rightarrow \mathbb{k}$.

(d) The simplicial cochain algebra C_{PL} , and the main theorem.

Recall from §5 that with every topological space X is associated to its singular cochain algebra, $C^*(X; \mathbb{k})$. Recall that we simplify notation and write $C^*(X)$ for $C^*(X; \mathbb{k})$. Now the construction of $C^*(X)$ depends only on the singular simplices of X and their face and degeneracy maps; i.e., it depends only on the simplicial set $S_*(X)$. As such it generalizes to any simplicial set K to give the cochain algebra $C^*(K)$, also written $C^*(K; \mathbb{k})$ if we need to emphasize coefficients. More

- $C^*(K) = \{C^p(K)\}_{p \geq 0}$;
- $C^p(K)$ consists of the set maps $K_p \rightarrow \mathbb{k}$ vanishing on degenerate simplices.
- For $f \in C^p(K)$, $g \in C^q(K)$ the product is given by

$$(f \cup g)(\sigma) = (-1)^{pq} f(\partial_{p+1} \cdots \partial_{p+q} \sigma) \cdot g(\partial_0 \partial_0 \cdots \partial_0 \sigma), \quad \sigma \in K_{p+q}.$$

- The differential, d , is given by

$$(df)(\sigma) = \sum_{i=0}^{p+1} (-1)^{p+i+1} f(\partial_i \sigma) \quad , \sigma \in K_{p+1}, f \in C^p(K).$$

Observe that, by definition, $C^*(X) = C^*(S_*(X))$ for topological spaces X .

Next observe that a simplicial cochain algebra C_{PL} can be defined using the simplicial sets $\Delta[n] \subset S_*(\Delta^n)$ introduced in (a). Indeed since the face inclusions and degeneracy maps for the Δ^n have the form

$$\lambda_i = \langle e_0, \dots, \hat{e}_i, \dots, e_{n+1} \rangle : \Delta^n \rightarrow \Delta^{n+1}$$

and

$$\rho_j = \langle e_0, \dots, e_j, e_j, \dots, e_n \rangle : \Delta^{n+1} \rightarrow \Delta^n,$$

(cf. §4(a)) it follows that $S_*(\lambda_i)$ and $S_*(\rho_j)$ restrict to simplicial maps

$$[\lambda_i] : \Delta[n] \rightarrow \Delta[n+1] \quad \text{and} \quad [\rho_j] : \Delta[n+1] \rightarrow \Delta[n].$$

Thus we define $C_{PL} = \{(C_{PL})_n\}_{n \geq 0}$ by

- $(C_{PL})_n$ is the cochain algebra $C^*(\Delta[n])$.
- The face and degeneracy morphisms are the $C^*([\lambda_i])$ and $C^*([\rho_j])$.

Finally, let

$$C_{PL} \otimes A_{PL} = \{(C_{PL})_n \otimes (A_{PL})_n; \partial_i \otimes \partial_i; s_j \otimes s_j\}$$

be the tensor product simplicial cochain algebra (where $(C_{PL})_n \otimes (A_{PL})_n$ is the tensor product cochain algebra described in §3(c)). Morphisms

$$C_{PL} \rightarrow C_{PL} \otimes A_{PL} \leftarrow A_{PL}$$

are defined by $\gamma \mapsto \gamma \otimes 1$ and $\Phi \mapsto 1 \otimes \Phi$. Thus, for any simplicial set K they determine the natural cochain algebra morphisms

$$C_{PL}(K) \rightarrow (C_{PL} \otimes A_{PL})(K) \leftarrow A_{PL}(K).$$

Our main result, which now follows, is (together with its proof) due to Chris Watkiss [155] following the idea in Weil's proof [156] that de Rham cohomology and singular cohomology are isomorphic.

Theorem 10.9 [155] *Let K be a simplicial set. Then*

- (i) *There is a natural isomorphism $C_{PL}(K) \xrightarrow{\cong} C^*(K)$ of cochain algebras.*
- (ii) *The natural morphisms of cochain algebras,*

$$C_{PL}(K) \rightarrow (C_{PL} \otimes A_{PL})(K) \leftarrow A_{PL}(K)$$

are quasi-isomorphisms.

Substituting $S_*(X) = K$ in Theorem 10.9 we obtain

Corollary 10.10 *For topological spaces X there are natural quasi-isomorphisms of cochain algebras.*

$$C^*(X) \xrightarrow{\cong} (C_{PL} \otimes A_{PL})(X) \xleftarrow{\cong} A_{PL}(X) \quad \square$$

This gives the isomorphisms $H^*(X) \cong H(A_{PL}(X))$ promised in (10.1).

For the proof of Theorem 10.9 we require two lemmas.

Lemma 10.11 *There are natural isomorphisms $C_{PL}(K) \xrightarrow{\cong} C^*(K)$.*

proof: Each $\gamma \in C_{PL}^p(K)$, $p \geq 0$ determines the element $f \in C^p(K)$ given by

$$f(\sigma) = \gamma_\sigma(c_p) \quad , \quad \sigma \in K_p,$$

where c_p is the fundamental simplex of $\Delta[p]$. It follows, by a straightforward calculation from the definitions and (10.2), that the correspondence $\gamma \mapsto f$ is a cochain algebra morphism. To show it is injective, assume $\gamma \mapsto 0$. The elements $\alpha \in \Delta[n]_p$ are the linear simplices of the form $\langle e_{i_0}, \dots, e_{i_p} \rangle : \Delta^p \rightarrow \Delta^n$ with $i_0 \leq \dots \leq i_p$, and these can all be written as composites of face and degeneracy maps. It follows that for any $n \geq 0$ and any $\tau \in K_n$,

$$(\gamma_\tau)(\alpha) = (\gamma_\tau)(\alpha \circ c_p) = \gamma_{\tau \circ \alpha}(c_p) = 0.$$

Hence $\gamma = 0$ and our morphism is injective.

On the other hand, by Lemma 10.3 any $\sigma \in K_n$ determines a unique simplicial map $\sigma_* : \Delta[n] \rightarrow K$ such that $\sigma_*(c_n) = \sigma$. Thus, if $f \in C^p(K)$, we may define $\gamma \in C_{PL}^p(K)$ by $\gamma_\sigma = C^p(\sigma_*)(f)$. Clearly $\gamma \mapsto f$ and our morphism is surjective. \square

Lemma 10.12

(i) $H(C_{PL})_n = k = H((C_{PL})_n \otimes (A_{PL})_n)$, $n \geq 0$.

(ii) C_{PL} is extendable.

(iii) $C_{PL} \otimes A_{PL}$ is extendable.

proof: (i) The first assertion is the classical calculation of $H^*(\Delta[n])$ which is left to the reader; the second then follows from Lemma 10.7 (ii) and the fact that $H(-)$ commutes with tensor products (§3(e)).

(ii) The map $[\lambda_i] : \beta \mapsto \lambda_i \circ \beta$ is an isomorphism of the simplicial set $\Delta[n-1]$ onto a subsimplicial set $F(i) \subset \Delta[n]$. Thus it identifies a p -cochain $f_i \in C^p(\Delta[n-1])$ with a set map $f'_i : F(i)_p \rightarrow \mathbb{k}$. Given a sequence $f_i, i \in \mathcal{I} \subset \{0, \dots, n\}$ of such cochains, the condition $\partial_i f_j = \partial_{j-1} f_i, i < j$, implies that f'_i and f'_j restrict to the same function in $F(i)_p \cap F(j)_p$. Thus $\{f'_i\}$ defines a function from $\bigcup_{i \in \mathcal{I}} F(i)_p$ to \mathbb{k} , which then trivially extends to a function f in

$\Delta[n]_p$, vanishing on degenerate simplices. Thus f is an element in $C^p(\Delta[n])$ such that $\partial_i f = f_i, i \in \mathcal{I}$.

(iii) Suppose given elements $\Omega_i \in C^p(\Delta[n-1]) \otimes (A_{PL}^q)_{n-1}, i \in \mathcal{I} \subset \{0, \dots, n\}$, satisfying $\partial_i \Omega_j = \partial_{j-1} \Omega_i, i < j$. Write $\Omega_i = \sum_{\alpha} f_{i\alpha} \otimes \Phi_{i\alpha}$ and define

$\Omega'_i : F(i)_p \rightarrow (A_{PL}^q)_{n-1}$ by

$$\Omega'_i(\lambda_i \circ \tau) = (-1)^{pq} \sum_{\alpha} f_{i\alpha}(\tau) \Phi_{i\alpha}, \quad \tau \in \Delta[n-1]_p.$$

Now for each $\sigma \in \Delta[n]_p$ let $\mathcal{I}_{\sigma} \in \mathcal{I}$ be the set of indices i such that $\sigma \in F(i)_p$. It is immediate from the definition that the elements $\Omega'_i(\sigma) \in (A_{PL}^q)_{n-1}$ satisfy

$$\partial_i (\Omega'_j(\sigma)) = \partial_{j-1} (\Omega'_i(\sigma)) \quad , i < j \in \mathcal{I}_{\sigma}.$$

Since A_{PL} is extendable (Lemma 10.7 (iii)) we may find $\Phi_{\sigma} \in (A_{PL}^q)_n$ such that $\partial_i \Phi_{\sigma} = \Omega'_i(\sigma), i \in \mathcal{I}_{\sigma}$.

Finally, identify $C^p(\Delta[n]) \otimes (A_{PL}^q)_n$ with the set of functions $\Delta[n]_p \rightarrow (A_{PL}^q)_n$, just as above, and define $\Omega \in C^p(\Delta[n]) \otimes (A_{PL}^q)_n$ by

$$\Omega(\sigma) = \Phi_{\sigma} \quad , \sigma \in \Delta[n]_p.$$

It is then immediate that $(\partial_i \otimes \partial_i)\Omega = \Omega_i$, as desired. □

proof of Theorem 10.9: The first assertion is Lemma 10.11. The second follows by applying Proposition 10.5 to the morphisms

$$\theta_C : C_{PL} \rightarrow C_{PL} \otimes A_{PL} \quad \text{and} \quad \theta_A : A_{PL} \rightarrow C_{PL} \otimes A_{PL}$$

given by $\gamma \mapsto \gamma \otimes 1$ and $\Phi \mapsto 1 \otimes \Phi$. Indeed all three simplicial cochain algebras are extendable (Lemma 10.7 and Lemma 10.12). Moreover, again by the same two lemmas, for each $n \geq 0, H((C_{PL})_n) = H((A_{PL})_n) = H((C_{PL} \otimes A_{PL})_n) = \mathbb{k} \cdot 1$. This trivially implies that $H((\theta_C)_n)$ and $H((\theta_A)_n)$ are isomorphisms. Thus the hypotheses of (10.5) are indeed satisfied. □

Finally, let $L \subset K$ be a sub simplicial set. Then the quasi-isomorphisms of Theorem 10.9 restrict to quasi-isomorphism

$$C^*(K, L) \xrightarrow{\cong} (C_{PL} \otimes A_{PL})(K, L) \xleftarrow{\cong} A_{PL}(K, L).$$

Thus the two short exact sequences

$$0 \rightarrow C^*(K, L) \rightarrow C^*(K) \rightarrow C^*(L) \rightarrow 0$$

and

$$0 \rightarrow A_{PL}(K, L) \rightarrow A_{PL}(K) \rightarrow A_{PL}(L) \rightarrow 0$$

are connected by a chain (of length two) of quasi-isomorphisms. In particular the canonical isomorphisms of cohomology define an isomorphism of long exact cohomology sequences,

$$\begin{array}{ccccccccccc} \longrightarrow & H^i(K, L) & \longrightarrow & H^i(K) & \longrightarrow & H^i(L) & \longrightarrow & H^{i+1}(K, L) & \longrightarrow & & (10.13) \\ & \cong & & \cong & & \cong & & \cong & & & \\ \longrightarrow & H^i(A_{PL}(K, L)) & \longrightarrow & H^i(A_{PL}(K)) & \longrightarrow & H^i(A_{PL}(L)) & \longrightarrow & H^{i+1}(A_{PL}(K, L)) & \longrightarrow & & \end{array}$$

Of course K and L may be replaced here by a topological space X and a subspace A .

(e) Integration and the de Rham theorem.

If K is a simplicial set then $A_{PL}(K)$ is a commutative cochain algebra and $C^*(K)$ is not, which explains why in Theorem 10.9 we need to connect them by the chain of quasi-isomorphisms $C^*(K) \xrightarrow{\cong} \bullet \xleftarrow{\cong} A_{PL}(K)$. In this topic we show how ‘integration’ provides a natural direct quasi-isomorphism of cochain complexes

$$\oint_K : A_{PL}(K) \xrightarrow{\cong} C^*(K) .$$

The quasi-isomorphism \oint was first constructed in the 1930’s in the context of smooth manifolds and ordinary differential forms. In that setting the fact that \oint commutes with the differentials is precisely Stokes’ theorem: $\int_{\Delta} d\Phi = \int_{\partial\Delta} \Phi$, and the fact that $H(\oint)$ is an isomorphism was conjectured by E. Cartan and proved by de Rham [43].

Now recall the constructions in §10(c) and (d) of the simplicial cochain algebras A_{PL} and C_{PL} . We shall construct a quasi-isomorphism of simplicial cochain complexes, $\oint : A_{PL} \rightarrow C_{PL}$ (as defined in §10(a)) and set $\oint_K = \oint(K) : A_{PL}(K) \rightarrow C_{PL}(K) = C^*(K)$. There are a number of calculations (mostly omitted) which are usually easy consequences of the classical integration by parts formula,

$$\int_0^\lambda (\lambda - t)^k t^\ell dt = \frac{\ell}{k + 1} \int_0^\lambda (\lambda - t)^{k+1} t^{\ell-1} dt = \binom{k + \ell}{k}^{-1} \frac{\lambda^{k+\ell+1}}{k + \ell + 1} . \quad (10.14)$$

To define $\oint : A_{PL} \rightarrow C_{PL}$ we need to define a sequence of cochain complex morphisms

$$\dots \rightarrow (C_{PL})_n = C^*(\Delta[n]) , \quad n \geq 0 ,$$

compatible with the face and degeneracy maps. Recall that $(A_{PL})_n = \Lambda(t_1, \dots, t_n, dt_1, \dots, dt_n)$. Define a linear map $\int_n : (A_{PL})_n^n \rightarrow \mathbb{k}$ by setting

$$\begin{aligned} \int_n \left(t_1^{k_1} t_2^{k_2} \cdots t_n^{k_n} dt_1 \wedge \cdots \wedge dt_n \right) &= \int_0^1 dt_1 \int_0^{1-t_1} dt_2 \cdots \\ &\quad \int_0^{1-\sum_1^{n-1} t_i} t_1^{k_1} \cdots t_n^{k_n} dt_n \\ &= \frac{k_1! k_2! \cdots k_n!}{(k_1 + \cdots + k_n + n)!} . \end{aligned}$$

Now (cf. §10(a)) let $\sigma = \langle e_{i_0} \cdots e_{i_k} \rangle$ be a k -simplex of Δ^n ; i.e. $0 \leq i_0 \leq i_1 \leq \cdots \leq i_k \leq n$. Then σ determines the morphism $\sigma^* : (A_{PL})_n \rightarrow (A_{PL})_k$ given by $t_{i_j} \mapsto t_j$, $1 \leq j \leq k$, and $t_m \mapsto 0$ if $m \neq i_0, \dots, i_k$.

Define $\oint_n : (A_{PL})_n \rightarrow (C_{PL})_n$ by setting

$$\left(\oint_n \Phi \right) (\sigma) = (-1)^{\frac{k(k-1)}{2}} \int_k \sigma^* \Phi , \quad \begin{array}{l} \Phi \in (A_{PL})_n^k \\ \sigma \text{ a } k\text{-simplex of } \Delta^n. \end{array}$$

(Note that if σ is degenerate then $\sigma^* \Phi = 0$ and so $(\oint_n \Phi) (\sigma) = 0$, as required.)

Theorem 10.15

(i) $\oint = \{ \oint_n \} : A_{PL} \rightarrow C_{PL}$ is a quasi-isomorphism of simplicial cochain complexes.

(ii) For each simplicial set K and topological space X the linear maps $\oint_K = \oint(K)$ and $\oint_X = \oint(X)$ are natural quasi-isomorphisms

$$\oint_K : A_{PL}(K) \rightarrow C^*(K) \quad \text{and} \quad \oint_X : A_{PL}(X) \rightarrow C^*(X)$$

of cochain complexes.

proof: A quasi-isomorphism of extendable simplicial cochain complexes induces a quasi-isomorphism of cochain complexes when applied to any simplicial set (Proposition 10.5). Since $C^*(-) = C_{PL}(-)$ and since A_{PL} and C_{PL} are extendable (Lemmas 10.11, 10.7 and 10.12) the assertion (ii) of the theorem follows from assertion (i).

To prove (i) we show first that each \oint_n commutes with the differentials, which is essentially Stokes' theorem. For this it is sufficient to verify that

$$(-1)^{\frac{n(n-1)}{2}} \int_n d\Phi = (-1)^{\frac{(n-1)(n-2)}{2}} \sum_{i=0}^n (-1)^{n+i+1} \int_{n-1} \sigma_i^* \Phi , \quad \Phi \in (A_{PL})_n^{n-1} ,$$

where $\sigma_i = \langle e_0 \cdots e_{i-1} e_{i+1} \cdots e_n \rangle : \Delta^{n-1} \rightarrow \Delta^n$. By linearity it is enough to consider Φ of the form $t_1^{k_1} \cdots t_n^{k_n} dt_1 \wedge \cdots \widehat{dt_j} \cdots \wedge dt_n$ (dt_j is deleted). But in this case the formula is a straightforward calculation via (10.14).

Next the compatibility of the \mathcal{f}_n with the face and degeneracy morphisms follows from the equation

$$\begin{aligned} (\mathcal{f}_\tau A_{PL}(\sigma)\Phi)(\tau) &= (-1)^{\frac{k(k-1)}{2}} \int_k \tau^* \sigma^* \Phi = (-1)^{\frac{k(k-1)}{2}} \int_k (\sigma\tau)^* \Phi \\ &= (\mathcal{f}_n \Phi)(\sigma\tau) = (C_{PL}(\sigma)\mathcal{f}_n \Phi)(\tau), \end{aligned}$$

valid for all simplicial maps $\Delta^k \xrightarrow{\tau} \Delta^r \xrightarrow{\sigma} \Delta^n$ and all $\Phi \in (A_{PL})_n^k$.

Finally, to show that the \mathcal{f}_n are quasi-isomorphisms notice that $\mathcal{f}_n(1) = 1$ and recall that $H((A_{PL})_n) = \mathbb{k} = H((C_{PL})_n)$, $n \geq 0$ (Lemmas 10.7 and 10.12). \square

Remark Multiplication defines a morphism

$$\text{mult}_n : (C_{PL})_n \otimes (C_{PL})_n \rightarrow (C_{PL})_n$$

of cochain complexes (but *not* of algebras), and so $\text{mult} = \{\text{mult}_n\}$ is a morphism of simplicial cochain complexes. Thus we have the commutative diagram

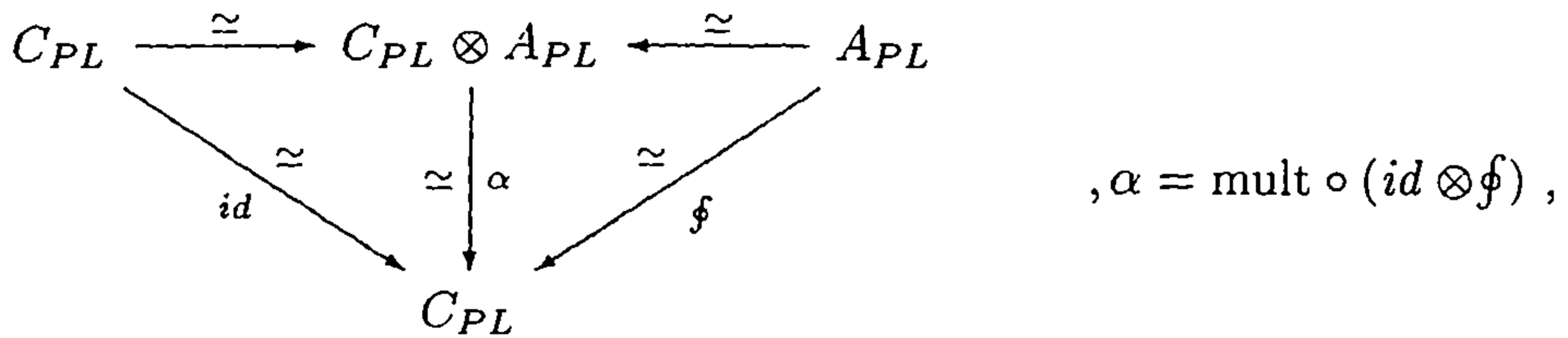

of simplicial cochain complexes, which translates to the obvious diagram when applied to any simplicial set or topological space. \square

Exercises

1. Prove that $A_{PL}(\ast) = \mathbb{k}$.
2. Give an explicit formula for each $\partial_i : (A_{PL})_1 \rightarrow (A_{PL})_0 \cong \mathbb{k}$ as defined in (c).
3. Let K be a simplicial set, and A, B simplicial cochain algebras. Prove that if $H(A) = \mathbb{k} = H(B)$ and if A and B are extendable then there exists a sequence of quasi-isomorphisms $A(K) \rightarrow A(K) \otimes B(K) \leftarrow B(K)$.
4. Prove that $A = \{(A_n, d_n)\}_{n \geq 0}, \partial_i, s_j$ is a simplicial algebra where $A_n = \wedge(x_0, x_1, \dots, x_n) \otimes \wedge(y_0, y_1, \dots, y_n)$ with $dx_i = y_i$ and

$$\partial_i(x_k) = \begin{cases} x_k & \text{if } k < i \\ 1 & \text{if } k = i \\ x_{k-1} & \text{if } k > i \end{cases} \quad \text{and} \quad s_i(x_k) = \begin{cases} x_k & \text{if } k < i \\ x_k x_{k+1} & \text{if } k = i \\ x_{k+1} & \text{if } k > i \end{cases} .$$

11 Smooth Differential Forms

In this section the ground ring is \mathbb{R} .

The construction $A_{PL}(-; \mathbb{K})$ of polynomial differential forms in §10 was suggested by the classical cochain algebra $A_{DR}(M)$ of smooth differential forms on a smooth manifold M . In this section we review the construction of $A_{DR}(M)$ and establish a chain of quasi-isomorphisms

$$A_{DR}(M) \xrightarrow{\cong} \cdots \xleftarrow{\cong} A_{PL}(M; \mathbb{R})$$

of commutative cochain algebras. This implies (§12) that $A_{DR}(M)$ and $A_{PL}(M; \mathbb{R})$ have the same minimal Sullivan algebras and hence that many rational homotopy invariants (e.g. $\dim \pi_k(M) \otimes \mathbb{Q}$, $k \geq 2$ and the rational LS category of M) can be computed directly from $A_{DR}(M)$.

This section is organized into the following topics:

- (a) Smooth manifolds.
- (b) Smooth differential forms.
- (c) Smooth singular simplices.
- (d) The weak equivalence $A_{DR}(M) \cong A_{PL}(M; \mathbb{R})$.

(a) Smooth manifolds.

A *topological n -manifold* M is a second countable metrizable topological space in which each point has an open neighbourhood homeomorphic to an open subset of \mathbb{R}^n . Recall that a map from an open subset of \mathbb{R}^n to \mathbb{R}^n is *infinitely differentiable* or *smooth* if all its partial derivatives of all orders exist. A *smooth atlas* $(U_\alpha, u_\alpha)_{\alpha \in I}$ for M is a covering of M by open sets U_α together with homeomorphisms u_α of U_α onto an open subset of \mathbb{R}^n , and such that for each $\alpha, \beta : u_\alpha u_\beta^{-1} : u_\beta(U_\alpha \cap U_\beta) \xrightarrow{\cong} u_\alpha(U_\alpha \cap U_\beta)$ is smooth. Each (U_α, u_α) is called a *chart* in the atlas. A *smooth n -manifold* is a topological n -manifold together with a smooth atlas.

Example 1 \mathbb{R}^n .

The identity map of \mathbb{R}^n identifies \mathbb{R}^n as a smooth manifold. □

Example 2 *Open subsets.*

Suppose $(U_\alpha, u_\alpha)_{\alpha \in I}$ is a smooth atlas for a smooth manifold M . If O is an open subset of M then $(U_\alpha \cap O, u_\alpha|_{U_\alpha \cap O})_{\alpha \in I}$ is a smooth atlas for O , and thus identifies O as a smooth manifold. □

Example 3 *Products.*

If $(U_\alpha, u_\alpha)_{\alpha \in \mathcal{I}}$ and $(V_\beta, v_\beta)_{\beta \in \mathcal{J}}$ are respectively smooth atlases for a smooth n -manifold M and a smooth k -manifold N then $(U_\alpha \times V_\beta, u_\alpha \times v_\beta)$ identifies $M \times N$ as a smooth $n + k$ manifold. \square

Suppose $(U_\alpha, u_\alpha)_{\alpha \in \mathcal{I}}$ and $(V_\beta, v_\beta)_{\beta \in \mathcal{J}}$ are respectively smooth atlases for a smooth n -manifold M and a smooth k -manifold N . A *smooth map* $f : M \rightarrow N$ is a continuous map such that each $v_\beta f u_\alpha^{-1} : u_\alpha(U_\alpha \cap f^{-1}(V_\beta)) \rightarrow v_\beta(V_\beta)$ is smooth. The composite of smooth maps is smooth, and a *diffeomorphism* is a smooth map admitting a smooth inverse. Finally a *smooth function* is a smooth map $M \rightarrow \mathbb{R}$ and pointwise addition and multiplication makes these into a commutative algebra, $C^\infty(M)$. For example, the smooth functions $u_\alpha^i : U_\alpha \rightarrow \mathbb{R}$ defined by $u_\alpha = (u_\alpha^1, \dots, u_\alpha^n)$ are called *local coordinates* in M . As another example, if $x \in O^{\text{open}} \subset M$ then there is always a smooth function $f : M \rightarrow [0, 1]$ which vanishes outside O , and is identically 1 in a neighbourhood of x [69, Prop. VIII, sec.1.8]. Such a function is called a *localizing function* for $x \in O$.

Two smooth maps $f, g : M \rightarrow N$ are *smoothly homotopic* if there is a smooth map $F : M \times \mathbb{R} \rightarrow N$ such that $F(-, 0) = f$ and $F(-, 1) = g$. For example, the identity map of \mathbb{R}^n is smoothly homotopic to the constant map $\mathbb{R}^n \rightarrow \{0\}$ [69, Example 1, sec. 1.10].

(b) Smooth differential forms.

Let M be a smooth n -manifold with smooth atlas $\{(U_\alpha, u_\alpha)\}$. Every smooth map $u : M \rightarrow N$ determines the morphism $C^\infty(u) : C^\infty(M) \leftarrow C^\infty(N)$ given by $C^\infty(u)f = f \circ u$.

Definition The *tangent space* $T_x M$ at $x \in M$ consists of the linear maps $\xi : C^\infty(M) \rightarrow \mathbb{R}$ such that $\xi(fg) = \xi f g(x) + f(x) \xi g$. If $u : M \rightarrow N$ is smooth then $T_x u : T_x M \rightarrow T_{u(x)} N$ is the linear map given by $(T_x u)\xi(f) = \xi(C^\infty(u)f)$.

If O is an open subset of \mathbb{R}^n then a canonical isomorphism $\mathbb{R}^n \xrightarrow{\cong} T_x O$ is given by $h \mapsto \xi_h$, where

$$\xi_h(f) = \lim_{t \rightarrow 0} \frac{f(x + th) - f(x)}{t},$$

[69, Prop. 1, sec. 3.3]. This isomorphism maps the standard basis of \mathbb{R}^n to the partial derivatives $\partial/\partial x^i$.

Moreover, if $i : O \rightarrow M$ is the inclusion of an open subset then each $T_x i$ is an isomorphism (use localizing functions) and, finally, if $F : M \rightarrow N$ is a diffeomorphism then each $T_x F$ is an isomorphism. Thus altogether we obtain isomorphisms

$$T_x M \xleftarrow{\cong} T_x U_\alpha \xrightarrow{\cong} T_{u_\alpha(x)}(u_\alpha U_\alpha) \xleftarrow{\cong} \mathbb{R}^n, \quad x \in U_\alpha. \quad (11.1)$$

The basis of $T_x M$ corresponding to the standard basis of \mathbb{R}^n will be denoted by $\frac{\partial}{\partial x^i}$, for the obvious reason.

Now suppose $f \in C^\infty(M)$. The *gradient of f at $x \in M$* is the linear map $(df)_x : T_x M \rightarrow \mathbb{R}$ given by $df_x(\xi) = \xi f$. The gradients $(du_\alpha^1)_x, \dots, (du_\alpha^n)_x$ are the basis of $(T_x M)^\sharp = \text{Hom}(T_x M, \mathbb{R})$ dual to the the basis $\frac{\partial}{\partial u_\alpha^i}$, and

$$df_x = \sum \frac{\partial f}{\partial u_\alpha^i}(x)(du_\alpha^i)_x . \quad (11.2)$$

A *differential p -form* on M is a family $\Phi = \{\Phi_x \in \Lambda^p(T_x M)^\sharp\}_{x \in M}$. For $x \in U_\alpha$ we have

$$\Phi_x = \sum_{i_1 < \dots < i_p} \lambda_{i_1 \dots i_p}(x)(du_\alpha^{i_1})_x \wedge \dots \wedge (du_\alpha^{i_p})_x$$

and Φ is called a *smooth differential p -form* if the $\lambda_{i_1 \dots i_p}$ are smooth functions in U_α . The vector space of smooth differential p -forms on M is denoted by $A_{DR}^p(M)$ and pointwise wedge multiplication makes $A_{DR}(M) = \{A_{DR}^p(M)\}_{p \geq 0}$ into a commutative graded algebra. Note that $A_{DR}^0(M) = C^\infty(M)$ and that $A_{DR}(M)$ vanishes in degrees $> n$.

Formula (11.2) shows that $df = \{(df)_x\}$ is a smooth 1-form on M ; it is called the *gradient of f* . Extend d to $A_{DR}^p(M)$, $p \geq 1$ as follows. For $\Phi \in A_{DR}^p(M)$ write $\Phi = \sum \lambda_{i_1 \dots i_p} du_\alpha^{i_1} \wedge \dots \wedge du_\alpha^{i_p}$ in U_α and define $d\Phi \in A_{DR}^{p+1}(M)$ by

$$d\Phi = \sum d\lambda_{i_1 \dots i_p} \wedge du_\alpha^{i_1} \wedge \dots \wedge du_\alpha^{i_p} .$$

It is straightforward to verify that this definition is independent of the choice of chart, and that d is a derivation of degree 1 in $A_{DR}(M)$. Moreover, for $f \in C^\infty(M)$ we have $d^2 f = d\left(\sum \frac{\partial f}{\partial u_\alpha^i} du_\alpha^i\right) = \sum_{i,j} \frac{\partial^2 f}{\partial u_\alpha^i \partial u_\alpha^j} du_\alpha^j \wedge du_\alpha^i = 0$ because of the symmetry of partial derivatives and the skew symmetry of the wedge product. It follows that $d^2 = 0$ in $A_{DR}(M)$ and so $A_{DR}(M)$ becomes a commutative cochain algebra.

Definition The cohomology algebra $H(A_{DR}(M))$ is called the *de Rham cohomology* of M .

Finally, if $F : M \rightarrow N$ is smooth then it is easy to see that $C^\infty(F)$ extends to a unique morphism $A_{DR}(F) : A_{DR}(M) \leftarrow A_{DR}(N)$ of cochain algebras (use localizing functions).

(c) Smooth singular simplices.

Recall that the standard simplex $\Delta^k \subset \mathbb{R}^{k+1}$ consists of the points $x = (t_0, \dots, t_k)$ such that each $t_i \geq 0$ and $\sum t_i = 1$. A *smooth singular k -simplex* in a smooth manifold M is a continuous map $\sigma : \Delta^k \rightarrow M$ that extends to a smooth map from some open neighbourhood of Δ^k in \mathbb{R}^{k+1} . The smooth singular simplices form a sub simplicial set, $S_*^\infty(M)$, of the simplicial set $S_*(M)$ of all singular simplices (§10(a)). The correspond cochain algebra (§10(d)) is denoted

by $C_\infty^*(M) = C^*(S_*^\infty(M); \mathbb{R})$. If $F : M \rightarrow N$ is smooth then $S_*(F)$ and $C^*(F)$ restrict (factor) to morphisms $S_*^\infty(F)$ and $C_\infty^*(F)$.

Next, we introduce smooth differential forms on the standard simplices, Δ^k , and the simplicial cochain algebra A_{DR} referred to briefly in §10(c). Note that the condition $\sum_0^k t_i = 1$ defines an affine k -space $F_k \subset \mathbb{R}^{k+1}$ which is, in particular a smooth k -manifold.

Set $T_x(\Delta^k) = T_x(F_k)$, $x \in \Delta^k$. Then a smooth differential p -form on Δ^k is a family $\Phi = \{\Phi_x \in \Lambda^p T_x(\Delta^k)^\# \}_{x \in \Delta^k}$ that extends to a smooth differential p -form on F_k ; as with smooth manifolds we denote the space of smooth differential p -forms on Δ^k by $A_{DR}^p(\Delta^k)$. It is easy to see that the kernel of $A_{DR}(F_k) \rightarrow A_{DR}(\Delta^k)$ is preserved by d , so that $A_{DR}(\Delta^k)$ inherits a differential.

Now let λ_i and ρ_j denote the face inclusions and degeneracies for the simplices Δ^k , as defined in §4(a). Then set $(A_{DR})_k = A_{DR}(\Delta^k)$ and observe that $\{(A_{DR})_n\}_{n \geq 0}, A_{DR}(\lambda_i), A_{DR}(\rho_j)$ is a simplicial cochain algebra, which we denote simply by A_{DR} . As observed in Remark 1 of §10(c), there is a natural inclusion

$$A_{PL}(\quad; \mathbb{R}) \rightarrow A_{DR}$$

of simplicial cochain algebras. Moreover, straightforward calculations establish

Lemma 11.3

- (i) $(A_{DR})_0 = \mathbb{R}$.
- (ii) $H((A_{DR})_n) = \mathbb{R}, n \geq 0$.
- (iii) Each A_{DR}^p is extendable.

□

(d) The weak equivalence $A_{DR}(M) \simeq A_{PL}(M; \mathbb{R})$.

Let M be a smooth manifold, and recall that $S_*^\infty(M)$ denotes the simplicial set of smooth singular simplices. In particular, we may apply the construction of §10(b) with the simplicial cochain algebra A_{DR} to obtain the cochain algebra $A_{DR}(S_*^\infty(M))$ whose elements are the families $\Phi = \{\Phi_\sigma \in A_{DR}(\Delta^{|\sigma|})\}_{\sigma \in S_*^\infty(M)}$ compatible with the face and degeneracy operators.

On the other hand, any $\sigma \in S_*^\infty(M)$ determines the morphism $A_{DR}(\sigma) : A_{DR}(M) \rightarrow A_{DR}(\Delta^{|\sigma|})$. Thus a natural morphism

$$\alpha_M : A_{DR}(M) \rightarrow A_{DR}(S_*^\infty(M))$$

is defined by $\alpha_M : \Phi \mapsto \{A_{DR}(\sigma)\Phi\}_{\sigma \in S_*^\infty(M)}$.

Moreover, recall that $A_{PL}(M; \mathbb{R}) = A_{PL}(S_*(M); \mathbb{R})$. Thus the inclusion $S_*^\infty(M) \rightarrow S_*(M)$ and $A_{PL}(\quad; \mathbb{R}) \rightarrow A_{DR}$ define natural morphisms

$$A_{DR}(S_*^\infty(M)) \xleftarrow{\beta_M} A_{PL}(S_*(M); \mathbb{R}) \xleftarrow{\gamma_M} A_{PL}(M; \mathbb{R}) .$$

Theorem 11.4 *The morphisms α_M, β_M and γ_M are all quasi-isomorphisms. In particular, $A_{DR}(M)$ is weakly equivalent to $A_{PL}(M; \mathbb{R})$.*

For the proof of Theorem 11.4 we consider first an arbitrary natural transformation $\theta : A \rightarrow B$ between functors from smooth n -manifolds to cochain algebras. We suppose, however, that

- (i) $H(A(\mathbb{R}^n)) = \mathbb{R} = H(B(\mathbb{R}^n))$.
- (ii) If U, V are open in M and θ_U, θ_V and $\theta_{U \cap V}$ are quasi-isomorphisms, then so is $\theta_{U \cup V}$.
- (iii) If $O = \coprod O_i$ is the disjoint union of open sets O_i then $\theta_O = \prod_i \theta_{O_i} : \prod_i A(O_i) \rightarrow \prod_i B(O_i)$.

Lemma 11.5 *With the hypotheses above, θ_M is a quasi-isomorphism for all smooth n -manifolds M .*

proof: An i -basis for M is a family of open sets $V_\lambda \subset M$, closed under finite intersection, and such that any open subset of M is the union of some of the V_λ . Given such an i -basis it is possible to write $M = O \cup W$ where $O = \coprod_i O_i$, $W = \coprod_j W_j$ and each O_i and W_j is a finite union of elements of the i -basis. If each θ_{V_λ} is a quasi-isomorphism it follows by induction on p that each $\theta_{V_{\lambda_1} \cup \dots \cup V_{\lambda_p}}$ is a quasi-isomorphism and hence that θ_O, θ_W and $\theta_{O \cap W}$ are too. Thus in this case θ_M is a quasi-isomorphism.

Now suppose U is open in \mathbb{R}^n . A *standard cube* in \mathbb{R}^n is an open set V of the form $(a_1, b_1) \times \dots \times (a_n, b_n)$ and each θ_V is a quasi-isomorphism by (i) above. But the standard cubes contained in U are an i -basis for U and so θ_U is a quasi-isomorphism. But the open subsets of M diffeomorphic to open subsets of \mathbb{R}^n are an i -basis for M and so θ_M is a quasi-isomorphism. □

proof of Theorem 11.4: (i) β_M is a quasi-isomorphism. Lemmas 10 and 11.4 assert that $A_{PL}(-; \mathbb{R}) \rightarrow A_{DR}$ is a quasi-isomorphism of extendable simplicial cochain algebras. Thus Proposition 10.5 asserts that β_M is a quasi-isomorphism.

(ii) γ_M is a quasi-isomorphism. The inclusion $S_*^\infty(M) \rightarrow S_*(M)$ induces $\varrho_M : C^*(M) \rightarrow C_\infty^*(M)$, and Theorem 10.9 identifies $H(\gamma_M)$ and $H(\varrho_M)$.

On the other hand if $f, g : M \rightarrow N$ are smoothly homotopic then the homotopy $C_*(f) - C_*(g) = dh + hd$ defined in §4(a) restricts to a homotopy between $C_*^\infty(f)$ and $C_*^\infty(g)$. Thus since the identity and constant maps in \mathbb{R}^n are smoothly homotopic we conclude that $H(C^*(\mathbb{R}^n)) = \mathbb{R} = H(C_\infty^*(\mathbb{R}^n))$.

Next, if U and V are open subsets of M then the barycentric subdivision argument [121] that shows that $C_*(U) + C_*(V) \xrightarrow{\cong} C_*(U \cup V)$ also shows that $C_*^\infty(U) + C_*^\infty(V) \xrightarrow{\cong} C_*^\infty(U \cup V)$. Thus a long exact homology sequence argument shows that if $C_*^\infty(U) \rightarrow C_*(U)$, $C_*^\infty(V) \rightarrow C_*(V)$ and $C_*^\infty(U \cap V) \rightarrow$

$C_*(U \cap V)$ are all quasi-isomorphisms then so is $C_*^\infty(U \cup V) \rightarrow C_*(U \cap V)$. Dually, if γ_U, γ_V and $\gamma_{U \cap V}$ are quasi-isomorphisms then so is $\gamma_{U \cup V}$.

Finally, if $O = \coprod_i O_i$ then clearly $\gamma_O = \prod_i \gamma_{O_i}$. Thus Lemma 11.5 asserts that γ_M is a quasi-isomorphism for all M .

(iii) α_M is a quasi-isomorphism. First note that $H(A_{DR}(\mathbb{R}^n)) = \mathbb{R}$ (classical Poincaré lemma — [69, Example 1, sec 5.5]) while $H(A_{DR}(S_*^\infty(\mathbb{R}^n))) = H(C_*^\infty(\mathbb{R}^n)) = \mathbb{R}$ as we showed in (ii) above. Next observe that if U and V are open in M then the difference of restriction morphisms defines a short exact sequence

$$0 \rightarrow A_{DR}(U \cup V) \rightarrow A_{DR}(U) \oplus A_{DR}(V) \rightarrow A_{DR}(U \cap V) \rightarrow 0$$

[69, Lemma 1, sec. 5.4]. Similarly we have the short exact sequence

$$0 \rightarrow A_{DR}(S_*^\infty(U) \cup S_*^\infty(V)) \rightarrow A_{DR}(S_*^\infty(U)) \oplus A_{DR}(S_*^\infty(V)) \rightarrow A_{DR}(S_*^\infty(U \cap V)) \rightarrow 0,$$

and a long exact cohomology sequence argument shows that the composite

$$A_{DR}(U \cup V) \rightarrow A_{DR}(S_*^\infty(U \cup V)) \rightarrow A_{DR}(S_*^\infty(U) \cup S_*^\infty(V))$$

is a quasi-isomorphism if α_U, α_V and $\alpha_{U \cap V}$ are.

Since Proposition 10.5 identifies $H(A_{DR}(K))$ with $H(C^*(K))$ for any simplicial set K and since as in (ii) above $H(C_*^\infty(U) + C_*^\infty(V)) \xrightarrow{\cong} H(C_*^\infty(U \cup V))$ it follows that $A_{DR}(S_*^\infty(U \cup V)) \rightarrow A_{DR}(S_*^\infty(U) \cup S_*^\infty(V))$ is also a quasi-isomorphism. Hence so is $\alpha_{U \cup V}$.

Finally, if $O = \coprod_i O_i$ then $\alpha_O = \prod_i \alpha_{O_i}$. Thus Lemma 11.5 states that α_M is a quasi-isomorphism for all M . □

Exercises

1. Let M be a differential manifold with a fixed open cover $\mathfrak{U} = \{U_0, U_1, \dots, U_m\}$. We denote by \mathcal{N}_p the set of sequences $I = (i_0, i_1, \dots, i_p)$ such that $0 \leq i_0 < i_1 < \dots < i_p \leq m$ and $U_I := U_{i_0} \cap U_{i_1} \cap \dots \cap U_{i_p} \neq \emptyset$. Define $\partial_l : \mathcal{N}_{p+1} \rightarrow \mathcal{N}_p$ by $\partial_l(i_0, i_1, \dots, i_{p+1}) = (i_0, i_1, \dots, \hat{i}_l, \dots, i_{p+1})$ and denote by $\rho_L^K : A_{DR}(U_L) \rightarrow A_{DR}(U_K)$ the restriction map induced by an inclusion $U_K \subset U_L$. We set:

$$C^n = \bigoplus_{p+q=n} C^{p,q}(\mathfrak{U}), \quad C^{p,q}(\mathfrak{U}) = \prod_{I \in \mathcal{N}_p} A^q(U_I), \quad \omega \in C^{p,q}(\mathfrak{U}), \quad \omega = (\omega_I)_{I \in \mathcal{N}_p}$$

$$d' : C^{p,q}(\mathfrak{U}) \rightarrow C^{p+1,q}(\mathfrak{U}), \quad d'' : C^{p,q}(\mathfrak{U}) \rightarrow C^{p,q+1}(\mathfrak{U})$$

$$(d'\omega)_J = \sum_{l=0}^{p+1} (-1)^{q+l} \rho_{\partial_l, J}^J \omega_{\partial_l, J}, \quad J \in \mathcal{N}_{p+1}, \quad (d''\omega)_I = d(\omega_I), \quad I \in \mathcal{N}_p$$

Prove that $(C^*(\mathfrak{U}), d' + d'')$ is a cochain algebra with the product defined by:

$$\omega \in C^{p,q}(\mathfrak{U}), \quad \omega' \in C^{p',q'}(\mathfrak{U}), \quad (\omega \cup \omega')_K = (-1)^{p'q} \rho_I^K \omega_I \rho_{I'}^K \omega_{I'}$$

if $K = (i_0, i_1, \dots, p + p') \in \mathcal{N}_{p+p'}$, and

$$I = (i_0, \dots, i_p) \in \mathcal{N}_p, \quad I' = (i_{p+1}, i_{p+2}, \dots, i_{p+p'}) \in \mathcal{N}_{p'}.$$

Is this product commutative? Prove that if each U_i is contractible in M then the graded algebra $H(C^*(\mathcal{U}), d' + d'')$ is isomorphic to $H^*(M; \mathbb{R})$.

2. Let M be a connected n -manifold and take a nicely imbedded n -disk D in M . Denote by $A'(M)$ the subalgebra of differential forms on M vanishing on the disk D . Prove that there is a sequence of quasi-isomorphisms

$$\hat{A}(M) \xrightarrow{\cong} A'(M) \xrightarrow{\cong} A_{DR}(M),$$

where $\hat{A}(M)$ denotes a connected subalgebra of $A'(M)$.

3. Let M and N be compact connected oriented n -manifolds. We define the *connected sum* of M and N , $M \# N$, as follows : take a nicely imbedded n -disk D in M and in N , remove their interiors, and paste the boundaries together via an orientation *reversing* homeomorphism. We use the notation of exercise 2) and denote by $\omega_M \in \hat{A}(M)$ (resp. $\omega_N \in \hat{A}(N)$) a cocycle representing the orientation class of M (resp. of N). Prove that there is a quasi-isomorphism:

$$([\hat{A}_{DR}(M) \oplus_{\mathbb{R}} \hat{A}(N)] \oplus u \cdot \mathbb{R}, d) \rightarrow A_{DR}(M \# N),$$

with $d(u) = \omega_M - \omega_N$. Deduce that the cohomology ring $H^*(M \# N; \mathbb{Z})$ is the direct sum of $H^*(M; \mathbb{Z})$ and $H^*(N; \mathbb{Z})$ with the units and the orientation classes identified.

12 Sullivan models

In this section the ground ring is an arbitrary field \mathbb{k} of characteristic zero.

Having constructed the functor

$$A_{PL} : \text{topological spaces} \rightsquigarrow \text{commutative cochain algebras}$$

in §10, and the functor A_{DR} : smooth manifolds \rightsquigarrow commutative cochain algebras in §11, we focus now on the study of commutative cochain algebras themselves. Here the principal role is played by the *Sullivan cochain algebras* (or *Sullivan algebras* for short) which we introduce now:

Definition A *Sullivan algebra* is a commutative cochain algebra of the form $(\Lambda V, d)$, where

- $V = \{V^p\}_{p \geq 1}$ and, as usual, ΛV denotes the free graded commutative algebra on V ;
- $V = \bigcup_{k=0}^{\infty} V(k)$, where $V(0) \subset V(1) \subset \dots$ is an increasing sequence of graded subspaces such that

$$d = 0 \quad \text{in} \quad V(0) \quad \text{and} \quad d : V(k) \longrightarrow \Lambda V(k-1), \quad k \geq 1.$$

The second condition is called the *nilpotence condition* on d . It can be restated as: d preserves each $\Lambda V(k)$, and there exist graded subspaces $V_k \subset V(k)$ such that $\Lambda V(k) = \Lambda V(k-1) \otimes \Lambda V_k$, with $d : V_k \rightarrow \Lambda V(k-1)$.

Observe that a Sullivan algebra is completely described by the vector space V and the linear operator, d . By contrast, for a general commutative cochain algebra (A, d_A) , the ‘non-linear’ multiplicative structure of A is also important. Nonetheless, if $H^0(A) = \mathbb{k}$ then we shall show that *there always exists a quasi-isomorphism from a Sullivan algebra to (A, d)* . This applies in particular to $A_{PL}(X)$ for X a path connected topological space, since $H^0(A_{PL}(X)) = H^0(X; \mathbb{k}) = \mathbb{k}$ (cf. (10.1)).

Definitions 1 A *Sullivan model* for a commutative cochain algebra (A, d) is a quasi-isomorphism

$$m : (\Lambda V, d) \longrightarrow (A, d)$$

from a Sullivan algebra $(\Lambda V, d)$.

2 If X is a path connected topological space then a Sullivan model for $A_{PL}(X)$,

$$m : (\Lambda V, d) \xrightarrow{\cong} A_{PL}(X),$$

is called a *Sullivan model for X* .

3 A Sullivan algebra (or model), $(\Lambda V, d)$ is called *minimal* if

$$\text{Im } d \subset \Lambda^+ V \cdot \Lambda^+ V.$$

We shall frequently abuse language and refer simply to $(\Lambda V, d)$ as the Sullivan model for (A, d) or for X . If $H^0(A) = \mathbb{k}$ then (A, d) always has a minimal Sullivan model, and this is *uniquely determined up to isomorphism*. This will be shown here in the simply connected case, and in general in §14. In §14 it will be shown that every Sullivan model (or algebra) is the tensor product of its unique minimal model with a Sullivan algebra of the form $(\Lambda(U \oplus \delta U), \delta)$, where $\delta : U \xrightarrow{\cong} \delta U$. Sullivan algebras of this form are called *contractible*.

Sullivan models for topological spaces X are, among all the commutative models, the ones that provide the key to unlocking the rational homotopy properties of X . For example, if $(\Lambda V, d)$ is a Sullivan model then (cf. (10.1)), as with any commutative model,

$$H(\Lambda V, d) \xrightarrow{\cong} H^*(X; \mathbb{k}).$$

However, if $(\Lambda V, d)$ is minimal there is also a natural isomorphism

$$V \xrightarrow{\cong} \text{Hom}_{\mathbb{Z}}(\pi_*(X); \mathbb{k}),$$

provided that X is simply connected and has rational homology of finite type. (The isomorphism is established in §15, based on a construction in §13.)

Recall further from §10 that if simply connected topological spaces X and Y have the same rational homotopy type, then $A_{PL}(X)$ and $A_{PL}(Y)$ are weakly equivalent. Since minimal models are unique up to isomorphism, this implies that $A_{PL}(X)$ and $A_{PL}(Y)$ have isomorphic minimal models: the *isomorphism class of a minimal model of X is an invariant of its rational homotopy type*. In §17 we shall show that this defines a *bijection*,

$$\left\{ \begin{array}{c} \text{rational homotopy} \\ \text{types} \end{array} \right\} \xrightarrow{\cong} \left\{ \begin{array}{c} \text{isomorphism classes of} \\ \text{minimal Sullivan algebras over } \mathbb{Q} \end{array} \right\}$$

where on the left we restrict to simply connected spaces with rational homology of finite type, and on the right to Sullivan algebras $(\Lambda V, d)$ with $V^1 = 0$ and each V^k finite dimensional.

Sullivan models also provide good descriptions of continuous maps, and of the relation of homotopy. Indeed, let $\Lambda(t, dt)$ be the free commutative graded algebra on the basis $\{t, dt\}$ with $\deg t = 0$, $\deg dt = 1$, and let d be the differential sending $t \mapsto dt$. As noted in §10, $H(\Lambda(t, dt)) = \mathbb{k}$. Define augmentations

$$\varepsilon_0, \varepsilon_1 : \Lambda(t, dt) \rightarrow \mathbb{k} \quad \text{by} \quad \varepsilon_0(t) = 0, \varepsilon_1(t) = 1.$$

Definition Two morphisms $\varphi_0, \varphi_1 : (\Lambda V, d) \rightarrow (A, d)$ from a Sullivan algebra to an arbitrary commutative cochain algebra are *homotopic* if there is a morphism

$$\Phi : (\Lambda V, d) \rightarrow (A, d) \otimes (\Lambda(t, dt), d)$$

such that $(id \cdot \varepsilon_i)\Phi = \varphi_i$, $i = 0, 1$. Here Φ is called a *homotopy* from φ_0 to φ_1 , and we write $\varphi_0 \sim \varphi_1$.

We shall see that homotopy is an equivalence relation. Moreover, suppose $m_X : (\Lambda V, d) \rightarrow A_{PL}(X)$ and $m_Y : (\Lambda W, d) \rightarrow A_{PL}(Y)$ are Sullivan models defined over \mathbb{Q} , and that $f : X \rightarrow Y$ is a continuous map. Then it turns out that there is a unique homotopy class of morphisms $\varphi : (\Lambda W, d) \rightarrow (\Lambda V, d)$ such that $m_X \varphi \sim A_{PL}(f)m_Y$: φ is called a *Sullivan representative* for f . Furthermore, the homotopy class of φ depends only on the homotopy class of f . If X and Y are rational spaces (cf. §9) with rational homology of finite type, then we shall show in §17 that $f \mapsto \varphi$ defines a bijection

$$\left\{ \begin{array}{l} \text{homotopy classes of} \\ \text{maps } X \rightarrow Y \end{array} \right\} \xrightarrow{\cong} \left\{ \begin{array}{l} \text{homotopy classes of} \\ \text{morphisms } (\Lambda W, d) \rightarrow (\Lambda V, d) \end{array} \right\}.$$

Finally, and perhaps of most importance, Sullivan algebras and models provide an effective computational approach to rational homotopy theory. In this and the next section we shall emphasize that approach, complementing the basic propositions with a range of examples. The introduction of relative Sullivan algebras, and the proofs of a number of theorems, follow in §14 and §15.

This section, then, is organized into the following topics:

- (a) Sullivan algebras and models: constructions and examples
- (b) Homotopy in Sullivan algebras.
- (c) Quasi-isomorphisms, Sullivan representatives, uniqueness of minimal models and formal spaces.
- (d) Computational examples.
- (e) Differential forms and geometric examples.

(a) Sullivan algebras and models: constructions and examples.

We begin by recalling notation and basic facts associated with free commutative graded algebras ΛV — cf. §3(b), Example 6. These will be used without further reference.

- $\Lambda V = \text{symmetric algebra } (V^{\text{even}}) \otimes \text{exterior algebra } (V^{\text{odd}})$. The subalgebras $\Lambda(V^{\leq p})$, $\Lambda(V^{> q})$, ... are denoted $\Lambda V^{\leq p}$, $\Lambda V^{> q}$, ...
- If $\{v_\alpha\}$ or v_1, v_2, \dots is a basis for V we write $\Lambda(\{v_\alpha\})$ or $\Lambda(v_1, v_2, \dots)$ for ΛV .
- $\Lambda^q V$ is the linear span of elements of the form $v_1 \wedge \dots \wedge v_q$, $v_i \in V$. Elements in $\Lambda^q V$ have wordlength q .
- $\Lambda V = \bigoplus_q \Lambda^q V$ and we write $\Lambda^{\geq q} V = \bigoplus_{i \geq q} \Lambda^i V$ and $\Lambda^+ V = \Lambda^{\geq 1} V$.
- If $V = \bigoplus_\lambda V_\lambda$ then $\Lambda V = \bigotimes_\lambda \Lambda V_\lambda$.

- Any linear map of degree zero from V to a commutative graded algebra A extends to a unique graded algebra morphism $\Lambda V \rightarrow A$.
- Any linear map of degree k ($k \in \mathbb{Z}$) from V to ΛV extends to a unique derivation of degree k in ΛV .

In particular the differential in a Sullivan algebra $(\Lambda V, d)$ decomposes uniquely as the sum $d = d_0 + d_1 + d_2 + \dots$ of derivations d_i raising the wordlength by i . The derivation d_0 is called the *linear part* of d .

Our first step is to show the existence of Sullivan models:

Proposition 12.1 *Any commutative cochain algebra (A, d) satisfying $H^0(A) = \mathbb{k}$ has a Sullivan model*

$$m : (\Lambda V, d) \xrightarrow{\cong} (A, d).$$

proof: We construct this so that V is the direct sum of graded subspaces V_k , $k \geq 0$ with $d = 0$ in V_0 and $d : V_k \rightarrow \Lambda \left(\bigoplus_{i=0}^{k-1} V_i \right)$. Choose $m_0 : (\Lambda V_0, 0) \rightarrow (A, d)$ so that

$$H(m_0) : V_0 \xrightarrow{\cong} H^+(A).$$

Since $H^0(A) = \mathbb{k}$, $H(m_0)$ is surjective.

Suppose m_0 has been extended to $m_k : \left(\Lambda \left(\bigoplus_{i=0}^k V_i \right), d \right) \rightarrow (A, d)$. Let z_α be cocycles in $\Lambda \left(\bigoplus_{i=0}^k V_i \right)$ such that $[z_\alpha]$ is a basis for $\ker H(m_k)$. Let V_{k+1} be a graded space with basis $\{v_\alpha\}$ in 1-1 correspondence with the z_α , and with $\deg v_\alpha = \deg z_\alpha - 1$. Extend d to a derivation in $\Lambda \left(\bigoplus_{i=0}^{k+1} V_i \right)$ by setting $dv_\alpha = z_\alpha$. Since d has odd degree, d^2 is a derivation. Since $d^2 v_\alpha = dz_\alpha = 0$, $d^2 = 0$.

Since $H(m_k)[z_\alpha] = 0$, $m_k z_\alpha = da_\alpha$, $a_\alpha \in A$. Extend m_k to a graded algebra morphism $m_{k+1} : \Lambda \left(\bigoplus_{i=0}^{k+1} V_i \right) \rightarrow A$ by setting $m_{k+1} v_\alpha = a_\alpha$. Then $m_{k+1} dv_\alpha = dm_{k+1} v_\alpha$, and so $m_{k+1} d = dm_{k+1}$.

This completes the construction of $m : (\Lambda V, d) \rightarrow (A, d)$ with $V = \bigoplus_{i=0}^{\infty} V_k$ and $m|_{V_k} = m_k$. Since $m|_{\Lambda V_0} = m_0$, and $H(m_0)$ is surjective, $H(m)$ is surjective as well. If $H(m)[z] = 0$ then, since z is necessarily in some $\Lambda \left(\bigoplus_{i=0}^k V_i \right)$, $H(m_k)[z] = 0$. By construction, z is a coboundary in $\Lambda \left(\bigoplus_{i=0}^{k+1} V_i \right)$. Thus $H(m)$ is an isomorphism.

We show next by induction on k that V_k is concentrated in degrees ≥ 1 . This is certainly true for $k = 0$, because $V_0 \cong H^+(A)$. Assume it true for V_i , $i \leq k$. Any element in $\Lambda \left(\bigoplus_{i=0}^k V_i \right)$ of degree 1 then has the form

$$v = v_0 + \cdots + v_k, \quad v_i \in V_i^1.$$

Thus if $dv = 0$ then $dv_k \in d \left(\Lambda \bigoplus_{i=0}^{k-1} V_i \right)$. By construction, this implies $v_k = 0$. Repeating this argument we find $v = v_0$ and $H(m_k)[v_0] = H(m_0)[v_0] \neq 0$, unless $v_0 = 0$. Thus $\ker H(m_k)$ vanishes in degree 1; i.e., it is concentrated in degrees ≥ 2 . It follows that V_{k+1} is concentrated in degrees ≥ 1 .

Finally, the nilpotence condition on d is built into the construction. \square

Example 1 *The spheres, S^k .*

Recall that in §4(c) we defined the fundamental class $[S^k] \in H_k(S^k; \mathbb{Z})$. This determines a unique class $\omega \in H^k(A_{PL}(S^k))$ such that $\langle \omega, [S^k] \rangle = 1$, and $1, \omega$ is a basis for $H(A_{PL}(S^k))$. Let Φ be a representing cocycle for ω .

Now if k is odd then a minimal Sullivan model for S^k is given by

$$m : (\Lambda(e), 0) \xrightarrow{\cong} A_{PL}(S^k), \quad \begin{array}{l} \deg e = k. \\ me = \Phi. \end{array}$$

Indeed, since k is odd, 1 and e are a basis for the exterior algebra $\Lambda(e)$.

Suppose, on the other hand, that k is even. We may still define $m : (\Lambda(e), 0) \rightarrow A_{PL}(S^k)$ by: $\deg e = k$, $me = \Phi$. But now, because $\deg e$ is even, $\Lambda(e)$ has as basis $1, e, e^2, e^3, \dots$ and this morphism is not a quasi-isomorphism. However, Φ^2 is certainly a coboundary. Write $\Phi^2 = d\Psi$ and extend m to

$$m : (\Lambda(e, e'), d) \rightarrow A_{PL}(S^k)$$

by setting $\deg e' = 2k - 1$, $de' = e^2$ and $me' = \Psi$. A simple computation shows that $1, e$ represents a basis of $H(\Lambda(e, e'), d)$. Thus this is a minimal model for S^k .

Finally, observe that quasi-isomorphisms

$$(\Lambda e, 0) \rightarrow (H^*(S^k), 0), \quad k \text{ odd} \quad \text{and} \quad (\Lambda(e, e'), d) \xrightarrow{\cong} (H^*(S^k), 0), \quad k \text{ even}$$

are given by $e \mapsto \omega$, $e' \mapsto 0$.

Example 2 *Products of topological spaces.*

Suppose $m_X : (\Lambda V, d) \rightarrow A_{PL}(X)$ and $m_Y : (\Lambda W, d) \rightarrow A_{PL}(Y)$ are Sullivan models for path connected topological spaces X and Y . Assume further that the rational homology of one of these spaces has finite type. Let $p^X : X \times Y \rightarrow X$ and $p^Y : X \times Y \rightarrow Y$ be the projections. Then $A_{PL}(p^X) \cdot A_{PL}(p^Y) : A_{PL}(X) \otimes A_{PL}(Y) \rightarrow A_{PL}(X \times Y)$ is a quasi-isomorphism of cochain algebras.

In fact, $A_{PL}(p^X) \cdot A_{PL}(p^Y)$ is clearly a morphism of graded vector spaces commuting with the differentials. It is a morphism of algebras because $A_{PL}(X \times Y)$ is commutative. To see that it is a quasi-isomorphism use Corollary 10.10 to identify the induced map of cohomology with the map

$$H^*(X; \mathbb{k}) \otimes H^*(Y; \mathbb{k}) \longrightarrow H^*(X \times Y; \mathbb{k})$$

given by $\alpha \otimes \beta \mapsto H^*(p^X)\alpha \cup H^*(p^Y)\beta$. But Proposition 5.3(ii) asserts that this map is an isomorphism.

Since $A_{PL}(p^X) \cdot A_{PL}(p^Y)$ is a quasi-isomorphism so is

$$m_X \cdot m_Y : (\Lambda V, d) \otimes (\Lambda W, d) \xrightarrow{\cong} A_{PL}(X \times Y),$$

where $(m_X \cdot m_Y)(a \otimes b) = A_{PL}(p^X)m_X a \cdot A_{PL}(p^Y)b$. This exhibits $(\Lambda V, d) \otimes (\Lambda W, d)$ as a Sullivan model for $X \times Y$. Observe that if $(\Lambda V, d)$ and $(\Lambda W, d)$ are minimal models then so is their tensor product. \square

Example 3 *H-spaces have minimal Sullivan models of the form $(\Lambda V, 0)$.*

An *H-space* is a based topological space $(X, *)$ together with a continuous map $\mu : X \times X \rightarrow X$ such that the self maps $x \mapsto \mu(x, *)$ and $x \mapsto \mu(*, x)$ of X are homotopic to the identity. We establish a result of Hopf:

- *If X is a path connected H-space such that $H_*(X; \mathbb{k})$ has finite type then $H^*(X; \mathbb{k})$ is a free commutative graded algebra.*

To see this, observe first that because $H_*(X; \mathbb{k})$ has finite type, $H^*(\mu)$ can be identified as a morphism of graded algebras,

$$H^*(\mu) : H^*(X; \mathbb{k}) \longrightarrow H^*(X; \mathbb{k}) \otimes H^*(X; \mathbb{k}).$$

Moreover, the conditions $\mu(x, *) \sim id, \mu(*, x) \sim id$ imply that for $h \in H^+(X; \mathbb{k})$,

$$H^*(\mu)h = h \otimes 1 + \Phi + 1 \otimes h, \quad \text{some } \Phi \in H^+(X; \mathbb{k}) \otimes H^+(X; \mathbb{k}).$$

Now choose a graded space $V \subset H^+(X; \mathbb{k})$ so that $H^+(X; \mathbb{k}) = V \oplus H^+(X; \mathbb{k}) \cdot H^+(X; \mathbb{k})$. The inclusion extends to a morphism $\varphi : \Lambda V \rightarrow H^*(X; \mathbb{k})$ of graded algebras and an obvious induction on degree shows that φ is surjective.

Suppose by induction that φ is injective in $\Lambda V^{<n}$, and let $\pi : H^*(X; \mathbb{k}) \rightarrow H^*(X; \mathbb{k})/\varphi(\Lambda V^{<n})$ be the (linear) quotient map. The general element in $\Lambda V^{\leq n}$ can be written as a finite sum $w = \sum_{k_1, \dots, k_r} v_1^{k_1} v_2^{k_2} \dots v_r^{k_r} a_{k_1 k_2 \dots k_r}$, where the

$a_{k_1 \dots k_r} \in \Lambda V^{<n}$, the v_i are linearly independent elements in V^n and $k_i = 1$ or 0 if n is odd. Then the component of $(\pi \otimes id)H^*(\mu)\varphi w$ in $(\text{Im } \pi)^n \otimes H^*(X; \mathbb{k})$ is given by

$$\sum_{i=1}^r \pm \pi v_i \otimes \varphi \left(\sum_{k_1, \dots, k_r} k_i v_1^{k_1} \dots v_i^{k_i-1} \dots v_r^{k_r} a_{k_1 \dots k_r} \right).$$

By construction, the πv_i are linearly independent. Hence if $\varphi w = 0$ then $\varphi \left(\sum k_i v_1^{k_1} \cdots v_i^{k_i-1} \cdots v_r^{k_r} a_{k_1 \dots k_r} \right) = 0$. By induction on $\deg w$, $\sum k_i v_1^{k_1} \cdots v_i^{k_i-1} \cdots v_r^{k_r} a_{k_1 \dots k_r} = 0$ for each i . Thus each $a_{k_1 \dots k_r} = 0$ unless $k_1 = \cdots = k_r = 0$. Then $w \in \Lambda V^{<n}$ and $\varphi w = 0$, whence $w = 0$ by induction. It follows that φ is injective in $\Lambda V^{\leq n}$. Thus, by induction, φ is injective and the proof of Hopf's result is complete:

$$\varphi : \Lambda V \xrightarrow{\cong} H^*(X; \mathbb{k}).$$

Finally, let $w_i \in A_{PL}(X)$ be cocycles representing the cohomology classes v_i . The correspondence $v_i \mapsto w_i$ defines a linear map $V \rightarrow A_{PL}(X)$ which extends to a unique morphism $m : (\Lambda V, 0) \rightarrow A_{PL}(X)$. Since φ is an isomorphism it follows that m is a quasi-isomorphism:

$$m : (\Lambda V, 0) \xrightarrow{\cong} A_{PL}(X)$$

is a minimal Sullivan model for the H -space X . □

Example 4 *A cochain algebra $(\Lambda V, d)$ that is not a Sullivan algebra.*

Consider the cochain algebra $(A, d) = (\Lambda(v_1, v_2, v_3), d)$, $\deg v_i = 1$, with $dv_1 = v_2 v_3$, $dv_2 = v_3 v_1$, and $dv_3 = v_1 v_2$. Here (A, d) is *not* a Sullivan algebra. (If it were, it would have to have a cocycle of degree 1). The cocycles 1 and $v_1 v_2 v_3$ represent a basis for $H(A)$, and so it has a minimal model

$$m : (\Lambda(w), 0) \xrightarrow{\cong} (\Lambda V, d), \quad \deg w = 3, \quad m(w) = v_1 v_2 v_3. \quad \square$$

Example 5 *In contrast with Example 4, any cochain algebra of the form*

$$(A, d) = (\Lambda V, d), \quad V = V^{\geq 2}, \quad \text{Im } d \subset \Lambda^+ V \cdot \Lambda^+ V$$

is automatically a minimal Sullivan algebra.

Indeed, in this case necessarily $(\Lambda^+ V \cdot \Lambda^+ V)^{k+1} \subset \Lambda V^{\leq k-1}$ and so for degree reasons alone,

$$d : V^k \rightarrow \Lambda V^{\leq k-1}.$$

This exhibits $(\Lambda V, d)$ as a Sullivan algebra. □

Again, suppose (A, d) is a commutative cochain algebra. In §14 we shall show that if $H^0(A) = \mathbb{k}$ then (A, d) has a (unique) *minimal* Sullivan model; this follows from a more general result about relative Sullivan algebras. However, if also $H^1(A) = 0$ then there is a simple inductive construction for a minimal model. We carry this out here, and prove uniqueness in this context in (c).

Thus suppose given (A, d) with $H^0(A) = \mathbb{k}$ and $H^1(A) = 0$.

- Choose $m_2 : (\Lambda V^2, 0) \rightarrow (A, d)$ so that $H^2(m_2) : V^2 \xrightarrow{\cong} H^2(A)$. Note that $H^1(m_2)$ is an isomorphism because $H^1(A) = 0$ and that $H^3(m_2)$ is injective because $(\Lambda V^2)^3 = 0$.

- Supposing that $m_k : (\Lambda V^{\leq k}, d) \rightarrow (A, d)$ is constructed, we extend to $m_{k+1} : (\Lambda V^{\leq k+1}, d) \rightarrow (A, d)$ by the following procedure.

Choose cocycles $a_\alpha \in A^{k+1}$ and $z_\beta \in (\Lambda V^{\leq k})^{k+2}$ so that

$$H^{k+1}(A) = \text{Im } H^{k+1}(m_k) \oplus \bigoplus_{\alpha} \mathbb{k} \cdot [a_\alpha] \quad \text{and} \quad \ker H^{k+2}(m_k) = \bigoplus_{\beta} \mathbb{k} \cdot [z_\beta].$$

In particular, $m_k z_\beta = db_\beta$, some $b_\beta \in A$.

Let V^{k+1} be a vector space (in degree $k + 1$) with basis $\{v'_\alpha, v''_\beta\}$ in 1-1 correspondence with the elements $\{a_\alpha\}, \{z_\beta\}$. Write $\Lambda V^{\leq k+1} = \Lambda V^{\leq k} \otimes \Lambda V^{k+1}$. Extend d and m_k , respectively, to a derivation in $\Lambda V^{\leq k+1}$ and to a morphism $m_{k+1} : \Lambda V^{\leq k+1} \rightarrow A$ of graded algebras, by setting

$$dv'_\alpha = 0, \quad dv''_\beta = z_\beta \quad \text{and} \quad mv'_\alpha = a_\alpha, \quad mv''_\beta = b_\beta.$$

Since d has degree 1, d^2 is a derivation. By construction, $d^2 = 0$ in V^{k+1} and in $\Lambda V^{\leq k}$. Thus $d^2 = 0$. In the same way $m_{k+1}d = dm_{k+1}$ in V^{k+1} and $\Lambda V^{\leq k}$, and so $m_{k+1}d = dm_{k+1}$.

Proposition 12.2 *Suppose (A, d) is a commutative cochain algebra such that $H^0(A) = \mathbb{k}$ and $H^1(A) = 0$. Then*

- (i) *The morphism $m : (\Lambda V, d) \rightarrow (A, d)$ constructed above is a minimal Sullivan model.*
- (ii) *If r is the least integer greater than zero such that $H^r(A) \neq 0$, then $V^i = 0$, $1 \leq i < r$ and*

$$H^r(m) : V^r \xrightarrow{\cong} H^r(A).$$

- (iii) *If $\dim H^k(A) < \infty$, $k \geq 1$, then $\dim V^k < \infty$, $k \geq 1$.*

proof: (i) Since $d : V^{k+1} \rightarrow \Lambda V^{\leq k}$, this exhibits $(\Lambda V, d)$ as a Sullivan algebra. More, $(\Lambda V^{\leq k})^{k+2} \subset \Lambda^+ V^{\leq k} \cdot \Lambda^+ V^{\leq k}$, and so $(\Lambda V, d)$ is minimal. It remains to show m is a quasi-isomorphism, and this follows at once from the assertion,

$$H^i(m_k) \text{ is } \begin{cases} \text{an isomorphism for } i \leq k \\ \text{injective for } i = k + 1 \end{cases}, \quad k \geq 2, \quad (12.3)$$

which we prove by induction on k .

For $k = 2$ (12.3) was observed at the start of the construction above. Suppose (12.3) holds for some k . Since m_{k+1} extends m_k , $\text{Im } H(m_k) \subset \text{Im } H(m_{k+1})$. Thus $H^i(m_{k+1})$ is surjective for $i \leq k$ by induction and surjective for $i = k + 1$ by construction.

To show $H^i(m_{k+1})$ is injective for $i \leq k + 2$ let $[z]$ be a cohomology class in $\ker H^i(m_{k+1})$, some $i \leq k + 2$. We have to show $[z] = 0$. If $\deg[z] \leq k$ or if

$\deg[z] = k + 2$ then $z \in \Lambda V^{\leq k}$ and $[z] \in \ker H^i(m_k)$. Thus $[z] = 0$ by induction if $\deg[z] \leq k$ and by construction if $\deg[z] = k + 2$.

Suppose $\deg[z] = k + 1$. Then $z = \sum \lambda_\alpha v'_\alpha + \sum \lambda_\beta v''_\beta + w$, some $w \in \Lambda V^{\leq k}$, where we use the notation from the construction above. Since $dz = 0$, $\sum \lambda_\beta z_\beta = -dw$ and $\sum \lambda_\beta [z_\beta] = 0$ in $H(\Lambda V^{\leq k})$. By construction, this implies that each $\lambda_\beta = 0$. But then $dw = 0$ and $\sum \lambda_\alpha [a_\alpha] = H^{k+1}(m_k)[w]$. Again by construction, each $\lambda_\alpha = 0$. Hence $z = w$ and so $[z] \in \ker H^{k+1}(m_k)$. By induction, $[z] = 0$.

(ii) This is immediate from the construction.

(iii) Since $V^2 \cong H^2(A)$, it is finite dimensional. Suppose by induction that V^i is finite dimensional, $i \leq k$. Then $\Lambda V^{\leq k}$ has finite type and, in particular, $\ker H^{k+2}(m_k)$ is finite dimensional. Since also $H^{k+1}(A)$ is finite dimensional it is immediate from the construction that $\dim V^{k+1} < \infty$. \square

Corollary *Let X be a simply connected topological space such that each $H_i(X; \mathbb{Q})$ is finite dimensional. Then X has a minimal Sullivan model*

$$m : (\Lambda V, d) \xrightarrow{\cong} A_{PL}(X)$$

such that $V = \{V^i\}_{i \geq 2}$ and each V^i is finite dimensional.

proof: The Hurewicz theorem 4.19 shows that $H_1(X; \mathbb{k}) = 0$, and $H^k(X; \mathbb{k})$ is the dual of the finite dimensional vector space $H_k(X; \mathbb{Q}) \otimes_{\mathbb{Q}} \mathbb{k}$ (cf. §3(e) and Proposition 5.3). Thus $H^0(A_{PL}(X)) = \mathbb{k}$, $H^1(A_{PL}(X)) = 0$ and each $H^k(A_{PL}(X))$ is finite dimensional. Now apply Proposition 12.2. \square

Example 6 *Simply connected topological spaces X with finite dimensional homology admit finite dimensional commutative models.*

Suppose X is a simply connected topological space such that $H_*(X; \mathbb{Q})$ is finite dimensional (e.g. a simply connected finite CW complex — cf. Theorem 4.18). Then X has a minimal model

$$m : (\Lambda V, d) \xrightarrow{\cong} A_{PL}(X)$$

in which $V = \{V^i\}_{i \geq 2}$ and each V^i is finite dimensional. In general, ΛV will not be finite dimensional, as is already shown by the even spheres S^{2r} (cf. Example 1).

There is, however, a ‘non-free’ finite dimensional commutative model for X , constructed as follows. Put

$$n_X = \max\{i \mid H^i(X; \mathbb{k}) \neq 0\}.$$

Write $(\Lambda V)^{n_X} = H \oplus (\text{Im } d)^{n_X} \oplus C$, where $H \oplus (\text{Im } d)^{n_X} = (\ker d)^{n_X}$; thus $H \xrightarrow{\cong} H^{n_X}(\Lambda V, d) \cong H^{n_X}(X; \mathbb{k})$. Choose a graded subspace $I \subset (\Lambda V, d)$ so that

$$\begin{aligned} I^k &= 0, \quad k < n_X - 1 & \text{and} & & I^{n_X - 1} \oplus (\ker d)^{n_X - 1} &= (\Lambda V)^{n_X - 1} \\ r_k - (\Lambda V)^k & \quad k > n_X & & & I^{n_X} &= (\text{Im } d)^{n_X} \oplus C. \end{aligned}$$

Since $V = \{V^i\}_{i \geq 2}$, I is an ideal. It is immediate from the construction that I is preserved by d and that $H(I, d) = 0$ (because $H^i(\Lambda V, d) = 0, i > n_X$). Thus the quotient map

$$\eta : (\Lambda V, d) \xrightarrow{\cong} ((\Lambda V)/I, d)$$

is a quasi-isomorphism, and so $((\Lambda V)/I, d)$ is a finite-dimensional commutative model for X .

Note that $(\Lambda V)/I$ vanishes in degrees $k > n_X$ and that $[((\Lambda V)/I)]^{n_X} = H^{n_X}((\Lambda V)/I)$. □

Example 7 *The minimal Sullivan algebra $(\Lambda(a, b, x, y, z), d)$, where*

$$da = db = 0, \quad dx = a^2, \quad dy = ab, \quad dz = b^2$$

and $\deg a = \deg b = 2$ and $\deg x = \deg y = \deg z = 3$.

Here, the cohomology algebra H has as basis

$$1, \quad \alpha = [a], \quad \beta = [b], \quad \gamma = [ay - bx], \quad \delta = [by - az], \quad \varepsilon = [aby - b^2x].$$

Note that $\alpha\delta = \varepsilon = \beta\gamma$, and that all other products of basis elements in H^+ are zero.

We can now use the procedure above to construct a minimal model for the cochain algebra $(H, 0)$. This will have the form $m : (\Lambda V, d) \xrightarrow{\cong} (H, 0)$, beginning with

$$\begin{array}{lll} V^2 : & v_1 & dv_1 = 0 & mv_1 = \alpha \\ & v_2 & dv_2 = 0 & mv_2 = \beta \\ \\ V^3 : & u_1 & du_1 = v_1^2 & mu_1 = 0 \\ & u_2 & du_2 = v_1v_2 & mu_2 = 0 \\ & u_3 & du_3 = v_2^2 & mu_3 = 0 \end{array}$$

Note that necessarily

$$m(v_1u_2 - v_2u_1) = 0 = m(v_2u_2 - v_1u_3).$$

Thus we need to add

$$\begin{array}{lll} V^4 : & x_1 & dx_1 = v_1u_2 - v_2u_1 & mx_1 = 0 \\ & x_2 & dx_2 = v_2u_2 - v_1u_3 & mx_2 = 0, \end{array}$$

and

$$\begin{array}{lll} V^5 : & y_1 & dy_1 = 0 & my_1 = \gamma \\ & y_2 & dy_2 = 0 & my_2 = \delta. \end{array}$$

The process turns out (but we can not yet prove this) to continue without end.

Observe that this provides two distinct minimal Sullivan algebras with the same cohomology algebra. □

(b) Homotopy in Sullivan algebras.

The results in this topic flow from two basic observations. First, consider a diagram of commutative cochain algebra morphisms

$$\begin{array}{ccc} & (A, d) & \\ & \simeq \downarrow \eta & \\ (\Lambda V, d) & \xrightarrow{\psi} & (C, d) \end{array}$$

in which η is a surjective quasi-isomorphism, and $(\Lambda V, d)$ is a Sullivan algebra.

Lemma 12.4 (Lifting lemma) *There is a morphism $\varphi : (\Lambda V, d) \rightarrow (A, d)$ such that $\eta\varphi = \psi$ (φ is a lift of ψ through η).*

proof: We may suppose V is the increasing union of graded subspaces $V(k)$, $k \geq 0$ such that $V(k) = V(k-1) \oplus V_k$ and $d : V_k \rightarrow \Lambda V(k-1)$. Assume φ is constructed in $V(k-1)$ and let v_α be a basis of V_k . Then φdv_α is defined and $d(\varphi dv_\alpha) = \varphi(d^2 v_\alpha) = 0$. Furthermore,

$$\eta\varphi dv_\alpha = \psi dv_\alpha = d\psi v_\alpha.$$

Since η is a surjective quasi-isomorphism we can find $a_\alpha \in A$ so that $da_\alpha = \varphi dv_\alpha$ and $\eta a_\alpha = \psi v_\alpha$. Extend φ by setting $\varphi v_\alpha = a_\alpha$. □

Second, with a graded vector space $U = \{U^i\}_{i \geq 0}$ associate the commutative cochain algebra $(E(U), \delta)$, defined by

$$E(U) = \Lambda(U \oplus \delta U) \quad \text{and} \quad \delta : U \xrightarrow{\cong} \delta U.$$

It is augmented by $\varepsilon : (E(U), \delta) \rightarrow \mathbb{k}$, where $\varepsilon(U) = 0$. Note that if $U = \{U^i\}_{i \geq 1}$ then this is a Sullivan algebra. Cochain algebras of this form are called *contractible*. We recall a remark already made in §12:

Lemma 12.5 $\varepsilon : (E(U), \delta) \rightarrow \mathbb{k}$ is a quasi-isomorphism; i.e.

$$H(E(U), \delta) = \mathbb{k}.$$

proof: Let $\{u_\alpha\}$ be a basis for U . A direct calculation (using $\text{char } \mathbb{k} = 0$ if $\text{deg } u_\alpha$ is even) shows that $H(\Lambda(u_\alpha, du_\alpha)) = \mathbb{k}$. But $E(U) = \bigotimes_{\alpha} \Lambda(u_\alpha, \delta u_\alpha)$ and, since \mathbb{k} is a field, homology commutes with tensor products (Proposition 3.3). □

As a direct consequence of this lemma we obtain:

The surjective trick: *If (A, d) is any commutative cochain algebra, then the identity of A extends uniquely to a surjective morphism $\sigma : (E(A), \delta) \rightarrow (A, d)$.*

Thus any morphism $\varphi : (B, d) \rightarrow (A, d)$ of commutative cochain algebras factors as

$$(B, d) \xrightarrow[\simeq]{\lambda} (B, d) \otimes (E(A), \delta) \xrightarrow{\varphi \cdot \sigma} (A, d)$$

in which the inclusion $\lambda : b \mapsto b \otimes 1$ is a quasi-isomorphism and $\varphi \cdot \sigma$ is surjective.

Recall that $\Lambda(t, dt)$ denotes the special case of $(E(U), \delta)$ with $U = \mathbb{k}t$ and with $\deg t = 0$. It is precisely the cochain algebra $(A_{PL})_1$, of polynomial differential forms on the standard 1-simplex (§10 (c)). The augmentations $\varepsilon_0, \varepsilon_1 : \Lambda(t, dt) \rightarrow \mathbb{k}$, $\varepsilon_0(t) = 0, \varepsilon_1(t) = 1$, correspond to the inclusions of the endpoints.

As defined in the introduction to this section, two morphisms $\varphi_0, \varphi_1 : (\Lambda V, d) \rightarrow (A, d)$ from a Sullivan algebra are *homotopic* if there is a morphism

$$\Phi : (\Lambda V, d) \rightarrow (A, d) \otimes \Lambda(t, dt)$$

such that $(id \cdot \varepsilon_i)\Phi = \varphi_i, i = 0, 1$. Given that A_{PL} reverses arrows, and that $\Lambda(t, dt)$ is the algebra of polynomial differential forms on the standard 1-simplex, this is the obvious analogue of a topological homotopy $X \leftarrow X \times I$.

In fact, A_{PL} ‘preserves homotopy’ in the following sense. Suppose given continuous maps $f_0, f_1 : X \rightarrow Y$ and a morphism $\psi : (\Lambda V, d) \rightarrow A_{PL}(Y)$ from a Sullivan algebra $(\Lambda V, d)$.

Proposition 12.6 *If $f_0 \sim f_1 : X \rightarrow Y$ then $A_{PL}(f_0)\psi \sim A_{PL}(f_1)\psi : (\Lambda V, d) \rightarrow A_{PL}(X)$.*

proof: Identify $\Lambda(t, dt)$ as a subcochain algebra of $A_{PL}(I)$, by mapping $t \mapsto u \in A_{PL}^0(I)$, where u restricts to 0 at $\{0\}$ and to 1 at $\{1\}$. Denote by $j_0, j_1 : X \rightarrow X \times I$ the inclusions at the endpoints and by $p^X : X \times I \rightarrow X$ and $p^I : X \times I \rightarrow I$ the projections. Then

$$\begin{array}{ccc}
 A_{PL}(X) \otimes \Lambda(t, dt) & & \\
 \downarrow & \searrow^{(id \cdot \varepsilon_0, id \cdot \varepsilon_1)} & \\
 A_{PL}(p^X) \cdot A_{PL}(p^I) & & A_{PL}(X) \times A_{PL}(X) \\
 \downarrow & \nearrow_{(A_{PL}(j_0), A_{PL}(j_1))} & \\
 A_{PL}(X \times I) & &
 \end{array}$$

is a commutative diagram of cochain algebra morphisms.

Since $H(A_{PL}(p^X)) = H^*(p^X; \mathbb{k})$ is an isomorphism, $A_{PL}(p^X) \cdot A_{PL}(p^I)$ is a quasi-isomorphism. We now ‘make it surjective’. Let $U \subset A_{PL}(X \times I)$ be the kernel of $(A_{PL}(j_0), A_{PL}(j_1))$. The inclusion of U extends to a unique cochain algebra morphism

$$\varrho : (E(U), \delta) \rightarrow A_{PL}(X \times I).$$

Extend the diagram above to the commutative diagram

$$\begin{array}{ccc}
 A_{PL}(X) \otimes \Lambda(t, dt) \otimes (E(U), \delta) & & \\
 \downarrow & \searrow^{(id \cdot \varepsilon_0 \cdot \varepsilon, id \cdot \varepsilon_1 \cdot \varepsilon)} & \\
 A_{PL}(p^X) \cdot A_{PL}(p^I) \cdot \varrho & & A_{PL}(X) \times A_{PL}(X) \\
 \downarrow & \nearrow_{(A_{PL}(j_0), A_{PL}(j_1))} & \\
 A_{PL}(X \times I) & &
 \end{array}$$

Here $A_{PL}(p^X) \cdot A_{PL}(p^I) \cdot \varrho$ is, obviously, surjective, and it follows from Lemma 12.5 that it is a quasi-isomorphism too.

Let $H : X \times I \rightarrow Y$ be a homotopy from f_0 to f_1 . Use Lemma 12.4 to lift $A_{PL}(H)\psi : (\Lambda V, d) \rightarrow A_{PL}(X \times I)$ through the surjective quasi-isomorphism $A_{PL}(p^X) \cdot A_{PL}(p^I) \cdot \varrho$. This produces a morphism

$$\Psi : (\Lambda V, d) \rightarrow A_{PL}(X) \otimes \Lambda(t, dt) \otimes E(U).$$

Then set $\Phi = (id \otimes id \otimes \varepsilon)\Psi$; it is the desired homotopy from $A_{PL}(f_0)\psi$ to $A_{PL}(f_1)\psi$. □

As with homotopy of continuous maps, we have

Proposition 12.7 *Homotopy is an equivalence relation in the set of morphisms $\varphi : (\Lambda V, d) \rightarrow (A, d)$ from a Sullivan algebra.*

proof: Reflexivity is obvious: A homotopy $\Phi : (\Lambda V, d) \rightarrow (A, d) \otimes \Lambda(t, dt)$ from φ to φ is given by $\Phi(v) = \varphi v \otimes 1$. Symmetry is also easy: the automorphism $t \mapsto 1 - t$ of $\Lambda(t, dt)$ interchanges ε_0 and ε_1 . For transitivity, suppose

$$\Phi : (\Lambda V, d) \rightarrow (A, d) \otimes \Lambda(t_1, dt_1) \quad \text{and} \quad \Psi : (\Lambda V, d) \rightarrow (A, d) \otimes \Lambda(t_2, dt_2)$$

are homotopics from φ_0 to φ_1 and from φ_1 to φ_2 . Then Φ and Ψ define a morphism

$$\begin{aligned}
 (\Phi, \Psi) : (\Lambda V, d) &\rightarrow [(A, d) \otimes \Lambda(t_1, dt_1)] \times_A [(A, d) \otimes \Lambda(t_2, dt_2)] \\
 &= (A, d) \otimes [\Lambda(t_1, dt_1) \times_{\mathbb{K}} \Lambda(t_2, dt_2)],
 \end{aligned}$$

where the second fibre product is with respect to the augmentations $\varepsilon_1 : \Lambda(t_1, dt_1) \rightarrow \mathbb{K}$, $\varepsilon_1(t_1) = 1$, and $\varepsilon_0 : \Lambda(t_2, dt_2) \rightarrow \mathbb{K}$, $\varepsilon_0(t_2) = 0$.

Now consider the morphism,

$$(A_{PL})_{\varrho} = \frac{\Lambda(t_0, t_1, t_2, dt_0, dt_1, dt_2)}{(\varepsilon_+ \cdot -1 \cdot \varepsilon \cdot dt_+)} \rightarrow \Lambda(t_1, dt_1) \times_{\mathbb{K}} \Lambda(t_2, dt_2)$$

given by $t_0 \mapsto (1 - t_1, 1 - t_2)$, $t_1 \mapsto (t_1, 0)$, $t_2 \mapsto (0, t_2)$. Using Proposition 10.4(i) we may identify it with restriction

$$A_{PL}(\Delta[2]) \rightarrow A_{PL}(L),$$

where $L \subset \Delta[2]$ is the subsimplicial set with non-degenerate simplices $\langle e_0 \rangle$, $\langle e_1 \rangle$, $\langle e_2 \rangle$, $\langle e_0, e_1 \rangle$ and $\langle e_0, e_2 \rangle$. Schematically L is given by the solid lines in the diagram

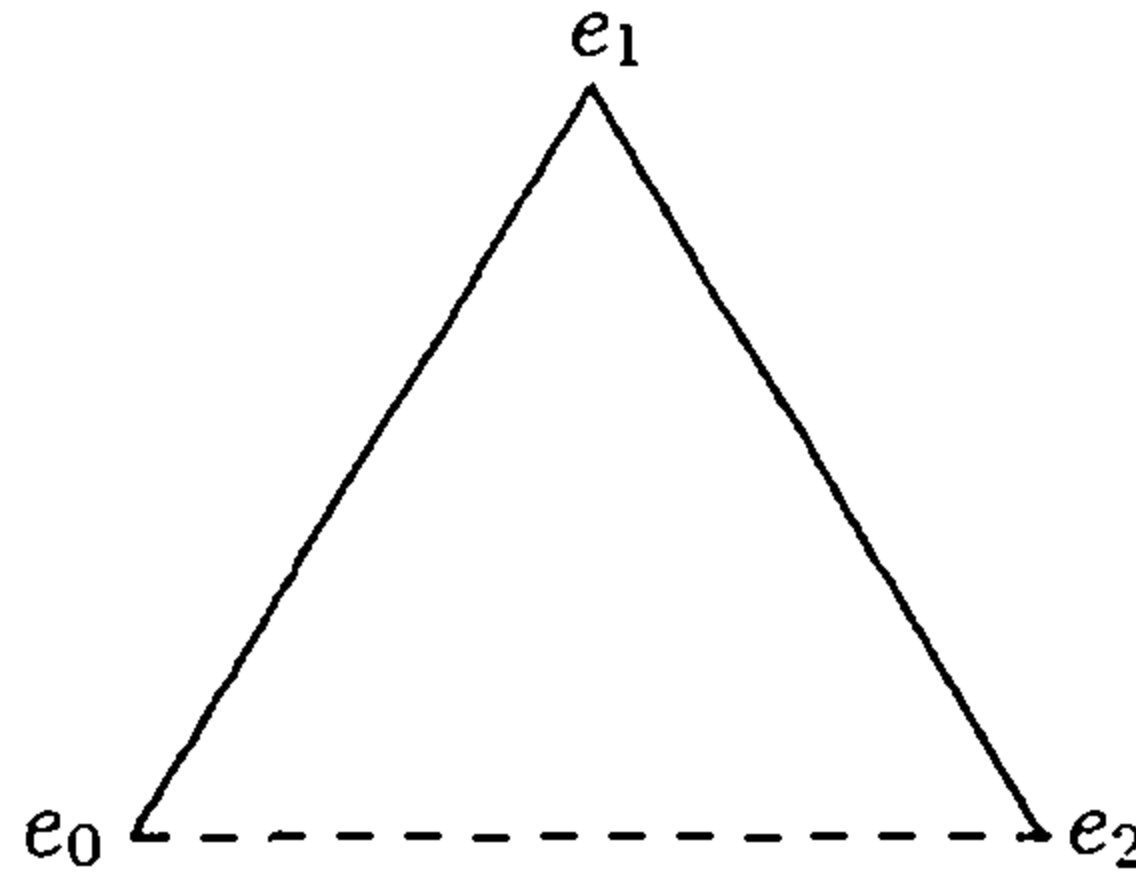

Since A_{PL} is extendable (Lemma 10.7(iii)) this morphism is surjective. Direct computation shows that $H((A_{PL})_2) = H(A_{PL}(L)) = \mathbb{k}$. Apply the Lifting Lemma 12.4 to lift (Φ, Ψ) to a morphism

$$\Omega : (\Lambda V, d) \rightarrow (A, d) \otimes (A_{PL})_2.$$

Define $\varrho : (A_{PL})_2 \rightarrow \Lambda(t, dt)$ by $t_0 \mapsto 1 - t$, $t_1 \mapsto 0$, $t_2 \mapsto t$; i.e., ϱ is the face operator corresponding to $\langle e_0, e_2 \rangle : \Delta[1] \rightarrow \Delta[2]$. Then $(id \otimes \varrho)\Omega$ is a homotopy from φ_0 to φ_2 . □

Notation The set of homotopy classes of morphisms $(\Lambda V, d) \rightarrow (A, d)$ will be denoted by $[(\Lambda V, d), (A, d)]$. The homotopy class of a morphism φ will be denoted by $[\varphi]$. □

Example 1 *Null homotopic morphisms into $(A, 0)$ are constant.*

Let $(\Lambda V, d)$ be a minimal Sullivan algebra and let $(A, 0)$ be any commutative cochain algebra with zero differential. The *constant morphism* $\varepsilon : (\Lambda V, d) \rightarrow (A, 0)$ is defined by $\varepsilon(V) = 0$. We observe that for any morphism $\varphi : (\Lambda V, d) \rightarrow (A, 0)$,

$$\varphi \sim \varepsilon \iff \varphi = \varepsilon .$$

In fact, suppose $\Phi : (\Lambda V, d) \rightarrow A \otimes \Lambda(t, dt)$ is a homotopy from φ to ε and write $V = \bigcup_{k \geq -1} V(k)$ with $V(-1) = 0$ and $d : V(k) \rightarrow \Lambda^{\geq 2} V(k - 1)$. Assume by induction that $\Phi : V(k - 1) \rightarrow A \otimes \Lambda t \otimes dt$. Since $dt \wedge dt = 0$ it follows that $\Phi(\Lambda^{\geq 2} V(k - 1)) = 0$.

Choose $v \in V(k)$. Then $d(\Phi v) = \Phi(dv) = 0$. Hence $\Phi v \in (A \otimes 1) \oplus (A \otimes \Lambda t \otimes dt)$. Since $0 = \varepsilon v = (id \otimes \varepsilon_1)\Phi v$ it follows that $\Phi v \in A \otimes \Lambda t \otimes dt$. In other words, $\text{Im } \Phi \subset A \otimes \Lambda t \otimes dt$ and $\varphi = (id \otimes \varepsilon_0)\Phi = \varepsilon$. □

Definition The *linear part* of a morphism $\varphi : (\Lambda V, d) \rightarrow (\Lambda W, d)$ between Sullivan algebras is the linear map

$$Q\varphi : V \rightarrow W$$

defined by: $\varphi v - Q\varphi v \in \Lambda^{\geq 2}W, v \in V$.

Note that $Q(\varphi)$ commutes with the linear parts of the differentials: $Q(\varphi)d_0 = d_0Q(\varphi)$.

Proposition 12.8

(i) If $\varphi_0 \sim \varphi_1 : (\Lambda V, d) \rightarrow (A, d)$ are homotopic morphisms from an arbitrary Sullivan algebra then $H(\varphi_0) = H(\varphi_1)$.

(ii) If $\varphi_0 \sim \varphi_1 : (\Lambda V, d) \rightarrow (\Lambda W, d)$ are homotopic morphisms between minimal Sullivan algebras, and if $H^1(\Lambda V, d) = 0$, then $Q\varphi_0 = Q\varphi_1$.

proof: (i) Any element in $\Lambda(t, dt)$ can be uniquely written as $u = \lambda_0 + \lambda_1 t + \lambda_2 dt + x + dy$, where x and y are in the ideal $I \subset \Lambda(t)$ generated by $t(1-t)$ and $\lambda_i \in \mathbb{k}$. If Φ is a homotopy from φ_0 to φ_1 , define a linear map $h : \Lambda V \rightarrow A$ of degree -1 by

$$\Phi(z) = \varphi_0(z) + (\varphi_1(z) - \varphi_0(z))t - (-1)^{\deg z} h(z)dt + \Omega,$$

where $\Omega \in A \otimes (I \oplus d(I))$. A simple calculation gives $\varphi_1 - \varphi_0 = dh + hd$.

(ii) We first observe that $V^1 = 0$. Write $V = \bigcup_k V(k)$, with $d : V(k) \rightarrow \Lambda^{\geq 2}V(k-1)$. If $V^1(k-1) = 0$ then this implies that $d = 0$ in $V^1(k)$. But $\text{Im } d \subset \Lambda^{\geq 2}V$, and so no element of $V^1(k)$ can be a coboundary (except zero). Since $H^1(\Lambda V, d) = 0$ this implies $V^1(k) = 0$. The assertion $V^1 = 0$ follows by induction.

Now let $\Phi : (\Lambda V, d) \rightarrow (\Lambda W, d) \otimes \Lambda(t, dt)$ be a homotopy from φ_0 to φ_1 . Since $V = V^{\geq 2}$, it follows that $\Phi : V \rightarrow \Lambda^+W \otimes \Lambda(t, dt)$. Hence $\Phi : \Lambda^{\geq k}V \rightarrow \Lambda^{\geq k}W \otimes \Lambda(t, dt)$. In particular, it induces a linear map

$$\bar{\Phi} : \Lambda^+V/\Lambda^{\geq 2}V \rightarrow (\Lambda^+W/\Lambda^{\geq 2}W) \otimes \Lambda(t, dt).$$

By construction, $\bar{\Phi}$ is a map of cochain complexes. However, because $(\Lambda V, d)$ and $(\Lambda W, d)$ are minimal, the differential vanishes in the quotients $\Lambda^+/\Lambda^{\geq 2}$. Since $\Lambda^+V = V \oplus \Lambda^{\geq 2}V$ and $\Lambda^+W = W \oplus \Lambda^{\geq 2}W$ we may therefore identify $\bar{\Phi}$ as a linear map of cochain complexes

$$\bar{\Phi} : (V, 0) \rightarrow (W, 0) \otimes \Lambda(t, dt).$$

The space of cocycles in $(W, 0) \otimes \Lambda(t, dt)$ has the form $(W \otimes \mathbb{k} \cdot 1) \oplus (W \otimes \Lambda(t)dt)$. It follows that $(id \cdot \varepsilon_0)\bar{\Phi} = (id \cdot \varepsilon_1)\bar{\Phi}$; i.e., $Q(\varphi_0) = Q(\varphi_1)$. \square

(c) **Quasi-isomorphisms, Sullivan representatives, uniqueness of minimal Sullivan models and formal spaces.**

Suppose $\psi : (\Lambda W, d) \rightarrow (\Lambda V, d)$ is a morphism between Sullivan algebras. If Φ is a homotopy between $\varphi_0, \varphi_1 : (\Lambda V, d) \rightarrow (A, d)$ then $\Phi\psi : \varphi_0\psi \sim \varphi_1\psi$. Thus we can define

$$\psi^\# : [(\Lambda V, d), (A, d)] \rightarrow [(\Lambda W, d), (A, d)] \quad \text{by} \quad \psi^\#[\varphi] = [\varphi\psi].$$

Similarly, if $\eta : (A, d) \rightarrow (C, d)$ is a morphism of commutative cochain algebras then $(\eta \otimes id)\Phi : \eta\varphi_0 \sim \eta\varphi_1$. Thus we can define

$$\eta_\# : [(\Lambda V, d), (A, d)] \rightarrow [(\Lambda V, d), (C, d)] \quad \text{by} \quad \eta_\#[\varphi] = [\eta\varphi].$$

Now suppose given commutative cochain algebra morphisms

$$\begin{array}{ccc} & (A, d) & \\ & \simeq \downarrow \eta & \\ (\Lambda V, d) & \xrightarrow{\psi} & (C, d) \end{array}$$

in which η is a (*not necessarily surjective*) quasi-isomorphism and $(\Lambda V, d)$ is a Sullivan algebra. The Lifting lemma extends to the fundamental

Proposition 12.9 *There is a unique homotopy class of morphisms $\varphi : (\Lambda V, d) \rightarrow (A, d)$ such that $\eta\varphi \sim \psi$. Thus*

$$\eta_\# : [(\Lambda V, d), (A, d)] \xrightarrow{\cong} [(\Lambda V, d), (C, d)]$$

is a bijection.

proof: We prove the proposition first under the additional hypothesis that η is surjective. In this case the Lifting lemma 12.4 asserts that ψ lifts to a morphism $\varphi : (\Lambda V, d) \rightarrow (A, d)$ such that $\eta\varphi = \psi$. Thus $\eta_\#$ is certainly surjective.

To show $\eta_\#$ is injective, suppress the differentials from the notation (for simplicity). Use the morphisms $C \otimes \Lambda(t, dt) \xrightarrow{(id_C \cdot \varepsilon_0, id_C \cdot \varepsilon_1)} C \times C \xleftarrow{\eta \times \eta} A \times A$ to construct a fibre product, and observe (routine verification) that

$$(\eta \otimes id, id_A \cdot \varepsilon_0, id_A \cdot \varepsilon_1) : A \otimes \Lambda(t, dt) \rightarrow [C \otimes \Lambda(t, dt)] \times_{C \times C} (A \times A)$$

is a surjective quasi-isomorphism of cochain algebras.

Now suppose $\gamma_0, \gamma_1 : \Lambda V \rightarrow A$ are cochain algebra morphisms, and that Ψ is a homotopy from $\eta\gamma_0$ to $\eta\gamma_1$. Lift the morphism

$$(\Psi, \gamma_0, \gamma_1) : \Lambda V \rightarrow [C \otimes \Lambda(t, dt)] \times_{C \times C} (A \times A)$$

through the surjective quasi-isomorphism $(\eta \otimes id, id_A \cdot \varepsilon_0, id_A \cdot \varepsilon_1)$. This defines a morphism $\Phi : \Lambda V \rightarrow A \otimes \Lambda(t, dt)$, and it is immediate from the construction that $\Phi : \gamma_0 \sim \gamma_1$.

Finally, consider the general case, where η may not be surjective. Let $(E(C), \delta)$ be the acyclic cochain algebra of Lemma 12.5. Since $E(C) = \Lambda(C \oplus \delta C)$ and since $\delta : C \xrightarrow{\cong} \delta C$, a surjective morphism of graded algebras, $\varrho : E(C) \rightarrow C$, is defined by $c \mapsto c, \delta c \mapsto dc$. By inspection this is a morphism of cochain algebras. Consider the morphisms

$$(A, d) \begin{array}{c} \xleftarrow{id \cdot \varepsilon} \\ \xrightarrow{\lambda} \end{array} (A, d) \otimes (E(C), \delta) \xrightarrow{\eta \cdot \varrho} (C, d).$$

Since $H(E(C)) = \mathbb{k}$, $id \cdot \varepsilon$ and $\eta \cdot \varrho$ are surjective quasi-isomorphisms. Thus, by the argument above, $(id \cdot \varepsilon)_\#$ and $(\eta \cdot \varrho)_\#$ are isomorphisms. Since $(id \cdot \varepsilon)\lambda = id$, $\lambda_\#$ is the bijection inverse to $(id \cdot \varepsilon)_\#$. Hence $\eta_\# = (\eta \cdot \varrho)_\# \circ \lambda_\#$ is also a bijection. \square

Suppose

$$\alpha : (A, d) \rightarrow (A', d)$$

is an arbitrary morphism of commutative cochain algebras that satisfy $H^0(-) = \mathbb{k}$. Let $m : (\Lambda V, d) \xrightarrow{\cong} (A, d)$ and $m' : (\Lambda V', d) \rightarrow (A', d)$ be Sullivan models. By Proposition 12.9 there is a unique homotopy class of morphisms

$$\varphi : (\Lambda V, d) \rightarrow (\Lambda V', d)$$

such that $m'\varphi \sim \alpha m$.

Definition A morphism $\varphi : (\Lambda V, d) \rightarrow (\Lambda V', d)$ such that $m'\varphi \sim \alpha m$ is called a *Sullivan representative for α* . If $f : X \rightarrow Y$ is a continuous map then a Sullivan representative of $A_{PL}(f)$ is called a *Sullivan representative of f*

It follows at once from Proposition 12.6 that *Sullivan representatives of homotopic maps are homotopic morphisms*.

As a second application of Proposition 12.9 we deduce the uniqueness of minimal models in the simply connected case.

Proposition 12.10

- (i) A quasi-isomorphism between minimal Sullivan algebras is an isomorphism if both cohomology algebras vanish in degree one.
- (ii) If (A, d) is a commutative cochain algebra and $H^0(A) = \mathbb{k}, H^1(A) = 0$, then the minimal models of (A, d) are all isomorphic.

proof: (i) Let $\psi : (\Lambda V, d) \xrightarrow{\cong} (\Lambda W, d)$ be a quasi-isomorphism between minimal Sullivan algebras, and suppose $H^1(\Lambda V, d) = 0 = H^1(\Lambda W, d)$. Proposition 12.9 then yields a morphism $\varphi : (\Lambda W, d) \rightarrow (\Lambda V, d)$ such that $\psi\varphi \sim id$. Thus $\varphi\psi \sim id$ and (again by Proposition 12.9) it follows that $\varphi\psi \sim id$.

Now apply Proposition 12.8(ii) to conclude that $Q(\varphi)$ and $Q(\psi)$ are inverse isomorphisms of V with W . Since $Q(\psi)$ is surjective we have $W^k \subset \text{Im } \psi + \Lambda W^{\leq k-1}$. It follows by induction that W^k and hence $\Lambda W^{\leq k}$ are contained in $\text{Im } \psi$. Thus ψ is surjective.

Use the Lifting lemma 12.4 to choose φ so that $\psi\varphi = id$. Then φ is injective. But also $\psi\varphi\psi = \psi$, so that $\varphi\psi \sim id$. Now the argument just given shows that φ is surjective as well. Thus φ is an isomorphism and, since $\psi\varphi = id$, ψ is the inverse isomorphism.

(ii) Suppose $(\Lambda V, d) \xrightarrow[\cong]{m} (A, d) \xleftarrow[\cong]{m'} (\Lambda V', d)$ are minimal Sullivan models. Proposition 12.9 provides a morphism $\psi : (\Lambda V, d) \rightarrow (\Lambda V', d)$ such that $m'\psi \sim m$. Thus $H(m')H(\psi) = H(m)$ — Proposition 12.8(i) — and so ψ is a quasi-isomorphism. Now part (i) asserts ψ is an isomorphism. \square

Remark In §14, Proposition 12.9 will be extended to the non-simply-connected case.

Example 1 *Wedges.*

Since $A_{PL}(pt) = \mathbb{k}$ (§10(d)) the inclusion of a point $j : x \rightarrow X$ induces an augmentation

$$\varepsilon = A_{PL}(j) : A_{PL}(X) \rightarrow \mathbb{k} .$$

Let (X_α, x_α) be based CW complexes, so that $\varepsilon : A_{PL}(X_\alpha) \rightarrow \mathbb{k}$ are augmented cochain algebras. Denote by $j_\alpha : (X_\alpha, x_\alpha) \rightarrow (\bigvee_\alpha X_\alpha, \bar{x})$ the different inclusions into the wedge. Thus $\Phi \mapsto \{A_{PL}(j_\alpha)\Phi\}$ defines a morphism

$$A_{PL}(\bigvee_\alpha X_\alpha) \longrightarrow \left(\prod_\alpha \right)_{\mathbb{k}} (A_{PL}(X_\alpha))$$

to the fibre product over \mathbb{k} of the $A_{PL}(X_\alpha)$. This morphism, which is obviously surjective, induces the analogue

$$H^*(\bigvee_\alpha X_\alpha; \mathbb{k}) \longrightarrow \left(\prod_\alpha \right)_{\mathbb{k}} (H^*(X_\alpha, \mathbb{k})) ,$$

in cohomology and a cellular chains argument (§4(e)) shows this is an isomorphism.

Thus the first morphism is a quasi-isomorphism: *the fibre product of augmented commutative models for the X_α is an augmented commutative model for $\bigvee_\alpha X_\alpha$.*

Now suppose $m_\alpha : (\Lambda V_\alpha, d) \xrightarrow[\cong]{} A_{PL}(X_\alpha)$ are Sullivan models. Then the quasi-isomorphism

$$\left(\prod_\alpha \right)_{\mathbb{k}} (\Lambda V_\alpha, d) \xrightarrow[\cong]{} \left(\prod_\alpha \right)_{\mathbb{k}} (A_{PL}(X_\alpha))$$

identifies $\left(\prod_{\alpha}\right)_{\mathbb{k}} (\Lambda V_{\alpha}, d)$ as a commutative model for the wedge, $\bigvee_{\alpha} X_{\alpha}$. In particular, a Sullivan model for $\left(\prod_{\alpha}\right)_{\mathbb{k}} (\Lambda V_{\alpha}, d)$ is a Sullivan model for the wedge. \square

Recall (§10) that two commutative cochain algebras (A, d) and (A', d) are weakly equivalent if they are connected by a chain of quasi-isomorphisms. It follows from Proposition 12.9 that a Sullivan model $m : (\Lambda V, d) \xrightarrow{\cong} (A, d)$ lifts through such a chain to yield a Sullivan model $m' : (\Lambda V, d) \xrightarrow{\cong} (A', d)$. Hence (A, d) and (A', d) are weakly equivalent if and only if they have the same Sullivan models. (A common Sullivan model provides an obvious weak equivalence.)

A particularly important case of weak equivalence is identified in the

Definition A commutative cochain algebra (A, d) satisfying $H^0(A) = \mathbb{k}$ is *formal* if it is weakly equivalent to the cochain algebra $(H(A), 0)$. A path connected topological space, X , is *formal* if $A_{PL}(X; \mathbb{Q})$ is a formal cochain algebra.

Thus (A, d) and X are formal if and only if their minimal Sullivan models can be computed directly from their cohomology algebras; i.e, if these models are a 'formal consequence' of the cohomology.

The quasi-isomorphisms at the end of Example 1, part (a) of this section, exhibit the spheres as formal spaces. Example 2 of §12(a) shows that the product of formal spaces is formal if one of them has rational homology of finite type, and the example above shows that the wedge of formal spaces is formal.

Suppose now that X has rational homology of finite type. Then the equality $(A_{PL, \mathbb{k}})_n = (A_{PL, \mathbb{Q}})_n \otimes \mathbb{k}$ defines an inclusion $A_{PL}(X; \mathbb{Q}) \otimes_{\mathbb{Q}} \mathbb{k} \rightarrow A_{PL}(X; \mathbb{k})$ of cochain algebras. Since the hypothesis implies that $H^*(X; \mathbb{Q}) \otimes_{\mathbb{Q}} \mathbb{k} \xrightarrow{\cong} H^*(X; \mathbb{k})$, this is a quasi-isomorphism. Thus if $(\Lambda V, d)$ is a rational Sullivan model for X then $(\Lambda V, d) \otimes_{\mathbb{Q}} \mathbb{k}$ is a Sullivan model for X over \mathbb{k} .

In particular, if X is formal then $A_{PL}(X; \mathbb{k})$ is formal. In fact the converse is true:

Theorem [144] [86] *If $A_{PL}(X; \mathbb{k})$ is formal for some extension field $\mathbb{k} \supset \mathbb{Q}$ then X is a formal space.*

We shall not reproduce the somewhat technical proof, and we shall not often need to apply the theorem except in the case of geometric examples arising from C^{∞} differential forms.

(d) Computational examples.

By using Sullivan algebras and computing homotopy classes of morphisms it is possible to illustrate interesting phenomena and, sometimes, to completely list all homotopy classes. Since Sullivan algebras (of finite type and with $H^1 = 0$)

are always the models of simply connected spaces (§15), such phenomena can always be realized geometrically.

We shall present Sullivan algebras in the concise form $(\Lambda V, d) = \Lambda(v_1, v_2, \dots; dv_1 =, \dots)$ and we shall only indicate the degree of a generator v_i when it is not implicit in the formula for dv_i .

Example 1 $(\Lambda V, d) = \Lambda(x, y, z; dx = dy = 0, dz = xy), \deg x = 3, \deg y = 5.$

A basis for the cohomology $H = H(\Lambda V, d)$ is provided by $1, [x], [y], [xz], [yz]$ and $[xyz]$, and the only non-trivial products are given by

$$[x] \cdot [yz] = [xyz] = -[y][xz].$$

Consider all the possible morphisms $\varphi : (\Lambda V, d) \rightarrow (H, 0)$. For degree reasons, we must have

$$\varphi x = \lambda[x], \quad \varphi y = \mu[y], \quad \text{and} \quad \varphi z = 0, \quad \text{some } \lambda, \mu \in \mathbb{K}.$$

These morphisms induce distinct maps in cohomology, and hence represent distinct homotopy classes. Thus this provides a complete list of the elements in $[(\Lambda V, d), (H, 0)]$. Note that none of these morphisms is a quasi-isomorphism so that (as with Example 7 in (a)), $(\Lambda V, d)$ and $(H, 0)$ are not weakly equivalent: $(\Lambda V, d)$ is not formal. □

Example 2 *Automorphisms of the model of $S^3 \times S^3 \times S^5 \times S^6$.*

Note that the tensor product of commutative models (Sullivan or otherwise) is a commutative model of the topological product, as follows from §12(a). Thus $S^3 \times S^3 \times S^5 \times S^6$ is formal. In Example 1 of part (a) in this section we computed the minimal Sullivan models of spheres. This shows that the minimal model of $S^3 \times S^3 \times S^5 \times S^6$ has the form $(\Lambda V, d) = \Lambda(x, y, z, a, u; dx = dy = dz = da = 0, du = a^2)$. with $\deg x = \deg y = 3, \deg z = 5, \deg a = 6.$

Define an automorphism, φ , of this model by:

$$\varphi x = x, \quad \varphi y = y, \quad \varphi z = z, \quad \varphi a = a, \quad \varphi u = u + xyz.$$

Then $H(\varphi) = id$ and $Q(\varphi) = id$ but φ is not homotopic to the identity.

Indeed, suppose $\varphi_0 \sim \varphi_1 : (\Lambda V, d) \rightarrow (\Lambda V, d)$ via a homotopy, Φ . For degree reasons, $\Phi a = a \otimes f_1(t) + xy \otimes f_2(t) + z \otimes f_3(t)dt$. Similarly, $\Phi u = u \otimes g_1(t) + xyz \otimes g_2(t) + za \otimes g_3(t)$. From $d\Phi a = 0$ deduce $f_1, f_2 \in \mathbb{K}$. If $\varphi_0 a = a$ it follows that $f_1 = 1$ and $f_2 = 0$. In this case the equation $d\Phi u = (\Phi a)^2$ implies that $g_1 = 1$, and $dg_2 = 0$. Thus $g_2 \in \mathbb{K}$ and $\varphi_0 u - \varphi_1 u = \lambda za$. In particular, φ is not homotopic to the identity. □

Example 3 $(\Lambda V, d) = \Lambda(a, x, b; da = dx = 0, db = ax), \deg a = 2, \deg x = 3.$

Let I be the ideal generated by a^2, xb^2, ab^2 and b^3 . It is preserved by d , so that a commutative cochain algebra (A, d) is defined by $A = \Lambda V/I$.

A basis for $H(A)$ is given by $1, [a], [x], [ab]$ and $[xb]$. In particular, $H^+(A) \cdot H^+(A) = 0$, and so $H(A) \cong H^*(S^2 \vee S^3 \vee S^6 \vee S^7; \mathbb{K})$. However (A, d) and $H^*(S^2 \vee S^3 \vee S^6 \vee S^7; \mathbb{K})$ are not weakly equivalent.

Indeed if they were, a minimal model for (A, d) would also be a minimal model for $H(A, d)$. The construction process of Proposition 12.2 produces a minimal model $(\Lambda W, d) \xrightarrow{\cong} (A, d)$ that is given in degrees ≤ 5 by $\Lambda(a, u, x, b; da = 0, du = a^2, dx = 0, db = ax)$. But any morphism from $(\Lambda W, d) \rightarrow (H(A, d), 0)$ sends $b \mapsto 0$ for degree reasons, and hence kills the cohomology class $[ab]$. \square

Example 4 $\Lambda(x, y, z, u; dx = dy = dz = 0, du = x^m + y^m - z^m)$, $\deg x = \deg y = \deg z = 2, m \geq 3, \mathbb{k} = \mathbb{Q}$.

A morphism $(\Lambda(x, y, z, u), d) \rightarrow (\Lambda a, 0)$, $\deg a = 2$, is given by $x \mapsto \lambda a, y \mapsto \mu a, z \mapsto \xi a$, where $\lambda^m + \mu^m = \xi^m$ and $\lambda, \mu, \xi \in \mathbb{Q}$. By Fermat's last theorem, one of λ, μ, ξ is zero. This illustrates how quickly number theoretic questions intervene in these computations. \square

Example 5 [66] *Two morphisms that homotopy commute, but are not homotopic to commuting morphisms.*

Define a minimal Sullivan algebra $(\Lambda V, d)$ by specifying the differential in a basis of V as follows:

V^3	V^5	V^6	V^7	V^{11}
x_1, x_2, x_3	y	z	v	w_1, w_2
$dx_i = 0$	$dy = x_2x_3$	$dz = 0$	$dv = yx_2$	$dw_1 = z^2, dw_2 = zx_1x_2$

Define two automorphisms $\varphi, \psi : (\Lambda V, d) \rightarrow (\Lambda V, d)$ by requiring

$$\varphi z = z + x_1x_2, \quad \varphi w_1 = w_1 + 2w_2, \quad \varphi = \text{identity on the other generators,}$$

and

$$\psi x_1 = x_1 + x_3, \quad \psi w_2 = w_2 - zy, \quad \psi = \text{identity on the other generators.}$$

Then a homotopy $\Phi : (\Lambda V, d) \rightarrow (\Lambda V, d) \otimes \Lambda(t, dt)$ from $\varphi\psi$ to $\psi\varphi$ is given by

$$\begin{aligned} \Phi x_1 &= x_1 + x_3, & \Phi z &= z + x_1x_2 + x_3x_2 + ydt, \\ \Phi w_1 &= w_1 + 2w_2 - 2yzt + 2x_1vdt + 2x_3vtdt, \\ \Phi w_2 &= w_2 - yz - x_1x_2y + x_1x_2yt + (2x_1 + x_3)vdt, \end{aligned}$$

and $\Phi = \text{identity on the other generators.}$ (This is a longish, but easy computation.)

On the other hand, if $\varphi \sim \varphi'$ then $H(\varphi') = H(\varphi)$. This implies that $\varphi'x_i = x_i$. Hence $0 = d(\varphi - \varphi')y$. There are no cocycles in degree 5, so $\varphi'y = \varphi y = y$. Again, because $H(\varphi') = H(\varphi)$ we have $\varphi'z = \varphi z + \lambda x_2x_3$, some $\lambda \in \mathbb{k}$. Similarly, if $\psi' \sim \psi$ then $\psi'x_i = \psi x_i, \psi'y = \psi y$ and $\psi'z = \psi z + \mu x_2x_3$, some $\mu \in \mathbb{k}$. A computation now shows that $\psi'\varphi'z \neq \varphi'\psi'z$.

The reader is challenged to show that $H(\Lambda V, d)$ is a finite dimensional algebra, with top cohomology class of degree 49.

Example 6 [57] *Sullivan algebras homogeneous with respect to word length.*

The differential in a Sullivan algebra $(\Lambda V, d)$ is said to be *homogeneous of degree k with respect to word length* if $d : V \rightarrow \Lambda^{k+1}V$. Thus if we let $H^{p,q} \subset H^{p+q}(\Lambda V)$ be the subspace represented by cocycles in $\Lambda^p V$ then $H^n = \bigoplus_{p+q=n} H^{p,q}$ and $H^{p,q} \cdot H^{r,s} \subset H^{p+r,q+s}$.

On the other hand, suppose a graded vector space V is presented as a direct sum of graded vector spaces: $V = \bigoplus_{m=0}^{\infty} V_m$. Then $\Lambda V = \bigoplus_{m=0}^{\infty} (\Lambda V)_m$, where $v_1 \wedge \dots \wedge v_r \in (\Lambda V)_m$ if $v_i \in V_{m_i}$ and $\sum m_i = m$. Thus if $(\Lambda V, d)$ is a Sullivan algebra and $d : V_m \rightarrow (\Lambda V)_{m-1}$, $m \geq 0$, then a ‘lower grading’ $H^r(\Lambda V, d) = \bigoplus_{m=0}^{\infty} H_m^r(\Lambda V, d)$ is induced in the cohomology algebra. Again, $H_m^r \cdot H_{m'}^{r'} \subset H_{m+m'}^{r+r'}$.

Now fix $k \geq 1$ and any graded vector space Z of the form $Z = \{Z^i\}_{i \geq 2}$. We shall construct a minimal Sullivan algebra $(\Lambda V, d)$ homogeneous with respect to word length of degree k and with the following properties:

- V is a graded vector space and $V = \{V^i\}_{i \geq 2}$.
- $V = \bigoplus_{m=0}^{\infty} V_m$ and $d : V_m \rightarrow (\Lambda^{k+1}V)_{m-1}$.
- $V_0 = Z$ and the inclusion induces an isomorphism $Z \xrightarrow{\cong} H^{1,*}(\Lambda V)$.
- $H^{\geq k+1,*}(\Lambda V) = 0$.

For this, set $V_0 = Z$, and $d = 0$ in Z . Next, construct d and V_m inductively so that $d : V_{m+1} \xrightarrow{\cong} (\Lambda^{k+1}V_{\leq m})_m \cap \ker d$. Then $H(d) : V_{m+1} \xrightarrow{\cong} H_m^{k+1,*}(\Lambda V_{\leq m}, d)$. Now the first three properties above are immediate, as is the fact that $H^{k+1,*}(\Lambda V, d) = 0$.

It remains to see that $H^{>k+1,*}(\Lambda V, d) = 0$. This is proved inductively as follows. Suppose $v_1, \dots, v_r \in V$ satisfy $dv_1 = 0$ and $dv_i \in \Lambda(v_1, \dots, v_{i-1})$. Then we can divide by v_1, \dots, v_r to obtain a quotient Sullivan algebra $(\Lambda W, \bar{d})$: here we may identify W with any complement of $\mathbb{k}v_1 \oplus \dots \oplus \mathbb{k}v_r$ in V . We call $(\Lambda W, \bar{d})$ an r -quotient, and show that:

$$\bullet \text{ For any } r\text{-quotient } (\Lambda W, \bar{d}), H^{\geq k+1,*}(\Lambda W, \bar{d}) = 0. \tag{12.11}$$

In fact suppose (12.11) is false. Then there is a least degree n in which it fails and a least $r = r_0$ for which it fails in that degree. Thus for any s -quotient $(\Lambda Z, \bar{d})$ and for any $p \geq k + 1$ we have:

$$H^{p,q}(\Lambda Z, \bar{d}) = 0 \quad \text{if } p + q < n \text{ or if } p + q = n \text{ and } s < r_0. \tag{12.12}$$

Now suppose $(\Lambda W, \bar{d})$ is any r_0 -quotient and Φ is a cocycle of degree n in $\Lambda^p W$ for some $p \geq k + 1$. We shall show Φ is a coboundary, thereby contradicting the hypothesis that (12.11) fails.

Suppose first $r_0 \geq 1$. Then there is an $(r_0 - 1)$ quotient of the form $(\Lambda v \otimes \Lambda W, \delta)$ projecting to $(\Lambda W, \bar{d})$. In particular, $\delta(1 \otimes \Phi) = v\Omega$, some $\Omega \in \Lambda v \otimes \Lambda W$. Now if $\deg v$ is odd then $\delta(1 \otimes \Phi) = v \otimes \Omega$ with $\Omega \in \Lambda W$. Moreover $\bar{d}\Omega = 0$, $\deg \Omega < n$ and $\Omega \in \Lambda^{\geq k+1} W$. Our hypothesis above implies that $\Omega = \bar{d}\Psi$ and so $\delta(1 \otimes \Phi + v \otimes \Psi) = 0$. On the other hand, if $\deg v$ is even then $v\delta\Omega = 0$. Thus Ω is a cocycle of degree $< n$ and word-length $\geq k + 1$ in an $(r_0 - 1)$ -quotient. Hence $\Omega = \delta\Psi$ and $\delta(1 \otimes \Phi - v\Psi) = 0$. In either case Φ lifts to a cocycle of degree n and word-length p in an $(r_0 - 1)$ -quotient. Our hypothesis implies that this cocycle is a coboundary; hence Φ is a coboundary in $(\Lambda W, \bar{d})$.

Finally, suppose $r_0 = 0$. In this case $(\Lambda W, \bar{d}) = (\Lambda V, d)$ and $H^{k+1,*}(\Lambda V) = 0$ by construction. Thus we may suppose $p \geq k + 2$. Now for $s \geq 1$ any s -quotient $(\Lambda Z, \bar{d})$ is the projection of an $(s - 1)$ -quotient of the form $(\Lambda v \otimes \Lambda Z, \delta)$. We shall show that if the image of Φ in $(\Lambda Z, \bar{d})$ is a coboundary then so is its image in $(\Lambda v \otimes \Lambda Z, \delta)$. Since (clearly) Φ maps to zero in some q -quotient it will follow that Φ itself is a coboundary.

Let Ψ be the image of Φ in $\Lambda v \otimes \Lambda Z$. Its image in ΛZ has the form $\bar{d}\Gamma$ and so $\Psi - \delta(1 \otimes \Gamma) = v\Omega$. If v has odd degree we may write $\Psi - \delta(1 \otimes \Gamma) = v \otimes \Omega$; here $\bar{d}\Omega = 0$ and Ω is a cocycle of word-length $p - 1 \geq k + 1$ in an s -quotient. Since $\deg \Omega < n$ we have $\Omega = \bar{d}\Omega'$ and $\Psi = \delta(1 \otimes \Gamma - v \otimes \Omega')$. If v has even degree then $\delta\Omega = 0$ and Ω is a cocycle in an $(s - 1)$ -quotient of word-length $\geq k + 1$ and degree $< n$. Thus $\Omega = \delta\Omega'$ and $\Psi = \delta(1 \otimes \Gamma + v\Omega')$. □

Example 7 *Sullivan models for cochain algebras $(H, 0)$ with trivial multiplication.*

Let $H = \mathbb{k} \oplus H^{\geq 2}$ be a graded algebra with trivial multiplication: $H^+ \cdot H^+ = 0$. Regard H as a cochain algebra with zero differential.

In Example 6 we constructed word-length homogeneous Sullivan algebras. Here we consider the case $k = 1$ and $Z = H^+$. Then the construction of Example 6 gives a Sullivan model of the form $(\Lambda V, d)$ with

$$V = H^+ \oplus V_1 \oplus \cdots \oplus V_m \oplus \cdots$$

$$d : V_m \rightarrow (\Lambda^2 V)_{m-1} ,$$

and

$$H^{1,*}(\Lambda V, d) = H^+ \quad \text{and} \quad H^{\geq 2,*}(\Lambda V, d) = 0 .$$

It follows that dividing by $\Lambda^{\geq 2} V$ and by $V_{\geq 1}$ defines a quasi-isomorphism

$$(\Lambda V, d) \xrightarrow{\cong} (H, 0)$$

which exhibits $(\Lambda V, d)$ as the minimal Sullivan model for $(H, 0)$. □

(e) Differential forms and geometric examples.

In this topic we take $\mathbb{k} = \mathbb{R}$.

Let M be a smooth manifold. In §11 we showed that $A_{DR}(M)$ was weakly equivalent to $A_{PL}(M; \mathbb{R})$. Thus *the Sullivan models of M are identified with the*

Sullivan models of $A_{DR}(M)$. This represents a significant strengthening of de Rham's theorem, which asserts that $H^*(M; \mathbb{R}) = H(A_{DR}(M))$.

In particular suppose M is simply connected and has finite dimensional rational homology, and let $(\Lambda V, d)$ be a minimal Sullivan model for $A_{DR}(M)$. Since this is also a model for $A_{PL}(M; \mathbb{R})$ we may conclude (taking for granted results announced in §12 and §13 and to be proved in §14 and §15) that

- $H(\Lambda V, d) \cong H^*(M; \mathbb{R})$ as graded algebras.
- $V \cong \text{Hom}(\pi_*(M), \mathbb{R})$.
- Whitehead products may be computed from the quadratic part of the differential, d .

Finally, with these hypotheses $A_{DR}(M)$ is connected to $A_{PL}(M; \mathbb{Q}) \otimes \mathbb{R}$ by quasi-isomorphisms of commutative cochain algebras (§11). It follows that $(\Lambda V, d) \cong (\Lambda W, d) \otimes \mathbb{R}$, where $(\Lambda W, d)$ is a rational minimal Sullivan model for M .

Since *geometric* restrictions on M (e.g. M admits an Einstein metric) are often expressed in terms of differential forms, it is natural to expect that these could lead to information about the model and hence to information about the homotopy groups of the manifold. Unfortunately results of this nature have, so far, proved to be elusive.

Now suppose a Lie group G acts on M , and let $A_{DR}(M)^G$ denote the sub cochain algebra of differential forms invariant under translation by $a \in G$. A theorem of E. Cartan [32], [70], asserts that if G is compact and connected, then the inclusion $A_{DR}(M)^G \rightarrow A_{DR}(M)$ is a quasi-isomorphism, and so $A_{DR}(M)^G$ is also a commutative model for M .

Example 1 *The cochain algebra $A_{DR}(G)^G$ of right invariant forms on G , and its minimal model.*

Let \mathfrak{g} be the Lie algebra of the group G , identified with the Lie algebra of right invariant vector fields on G . Regard $\mathfrak{g}^\sharp = \text{Hom}(\mathfrak{g}; \mathbb{R})$ as a graded vector space concentrated in degree 1. Let G act on itself by right translation. Then $A_{DR}(G)^G = (\Lambda \mathfrak{g}^\sharp, d)$, and the formula for the exterior derivative gives

$$\langle d\omega; x, y \rangle = -\langle \omega, [x, y] \rangle, \quad \begin{array}{l} \omega \in \mathfrak{g}^\sharp \\ x, y \in \mathfrak{g}. \end{array}$$

Because \mathfrak{g}^\sharp generates $\Lambda \mathfrak{g}^\sharp$ and because d is purely quadratic this formula determines d .

Although $\Lambda \mathfrak{g}^\sharp$ is a free commutative graded algebra, the cochain algebra $(\Lambda \mathfrak{g}^\sharp, d)$ does *not*, in general, satisfy the nilpotence condition required for Sullivan algebras. In fact, it is easy to see that $(\Lambda \mathfrak{g}^\sharp, d)$ is a Sullivan algebra if and only if \mathfrak{g} is a nilpotent Lie algebra.

On the other hand, G is always homeomorphic to the product of a compact Lie group with some \mathbb{R}^n [32]. In particular (as with any compact manifold, [43], [69]) $H_*(G; \mathbb{R})$ is a finite dimensional vector space. Thus the theorem of

Hopf (Example 3, §12(a)) shows that $H^*(G; \mathbb{R})$ is an exterior algebra on a finite dimensional vector space P concentrated in odd degrees. This gives a minimal Sullivan model

$$(\Lambda P, 0) \xrightarrow{\cong} A_{DR}(G),$$

which contrasts with the morphism $(\Lambda \mathfrak{g}^\#, d) \rightarrow A_{DR}(G)$. \square

Example 2 *Nilmanifolds.*

Let G be a nilpotent connected Lie group and let Γ be a discrete sub-group of G such that the quotient space $X = G/\Gamma$ is compact. The covering projection $\pi : G \rightarrow X$ induces an isomorphism $A_{DR}X \cong (A_{DR}G)^\Gamma$ (= the complex of right Γ -invariant differential forms on X). Thus we may regard $(A_{DR}G)^\Gamma$ as a subcochain algebra of $A_{DR}X$. In [130], K. Nomizu proved that this inclusion is a quasi-isomorphism.

In this case the Lie algebra \mathfrak{g} of G is nilpotent and so $(\Lambda \mathfrak{g}^\#, d)$ is a minimal model of X over the real numbers. Obviously, $d = 0$ if and only if the Lie algebra \mathfrak{g} is abelian. In this case $X = S^1 \times \cdots \times S^1$. In particular, X is formal. The converse is true. Indeed, assume that there exists a quasi-isomorphism $(\Lambda(x_1, x_2, \dots, x_k), d) \xrightarrow{\varphi} H^*(X; \mathbb{R})$. Then φ is obviously surjective, and since the product $x_1 x_2 \cdots x_k$ is a cocycle which cannot be a coboundary, φ is injective. This in turn implies that $d = 0$.

This result has been proved in many different manners: [23], [39], [50], [53], [88], [114]. \square

Example 3 *Symmetric spaces are formal.*

Suppose τ is an involution of a compact connected Lie group G , and that K is the connected component of the identity in the subgroup of elements fixed by τ . Then G/K is called a symmetric space of compact type. By Cartan's theorem, $A_{DR}(G/K)^\Gamma \xrightarrow{\cong} A_{DR}(G/K)$.

An argument of E. Cartan shows that the differential in $A_{DR}(G/K)^\Gamma$ is zero, thereby exhibiting G/K as a formal space. It is interesting to note that this is still the only proof available of the formality of G/K .

Cartan's argument runs as follows: observe that τ induces an involution σ of G/K and that $A_{DR}(\sigma)$ restricts to an involution of $A_{DR}(G/K)^\Gamma$. Since the action of G on G/K is transitive, $A_{DR}(G/K)^\Gamma$ may be identified with a subalgebra of $\Lambda T_\xi^*(G/K) = \Lambda(\mathfrak{g}/\mathfrak{k})^*$. Let $\tau' : TG \rightarrow TG$ and $\sigma' : TG/K \rightarrow TG/K$ denote the derivatives of τ and σ . Since τ is an involution and $\mathfrak{k} = \{h \in \mathfrak{g} \mid \tau' h = 1\}$, it follows that $\sigma' = -id$ in $\mathfrak{g}/\mathfrak{k}$. Hence $A_{DR}(\sigma) = (-1)^p id$ in $A_{DR}^p(G/K)^\Gamma$. Since $A_{DR}(\sigma)$ commutes with d , $d = 0$. \square

Example 4 (Deligne, Griffiths, Morgan and Sullivan [42]) *Compact Kähler manifolds are formal.*

Suppose M is a complex manifold with operator $J : T_x(M) \rightarrow T_x(M)$ satisfying $J^2 = -1$, $x \in M$. Let $\langle \cdot, \cdot \rangle$ be a Riemannian metric such that $\langle J\xi, J\eta \rangle = \langle \xi, \eta \rangle$. Define $\omega \in A_{DR}^2(M)$ by $\omega(\xi, \eta) = \langle J\xi, \eta \rangle$. M is called a Kähler manifold if $\langle \cdot, \cdot \rangle$ can be chosen so $d\omega = 0$.

Given a Kähler manifold, put $d^c = J^{-1}dJ : A_{DR}(M) \rightarrow A_{DR}(M)$. Then $(d^c)^2 = 0$ and $d^c d = d d^c$. In [42] the authors show that $d : \ker d^c \rightarrow \text{Im } d^c$ and that the obvious inclusion and surjection

$$A_{DR}(M) \xleftarrow{i} (\ker d^c, d) \xrightarrow{q} (\ker d^c / \text{Im } d^c, 0)$$

are quasi-isomorphisms. This exhibits M as formal.

Here, again, the only known proof of formality for Kähler manifolds proceeds via analysis using $A_{DR}(M)$. □

Example 5 *Symplectic manifolds need not be formal.*

A symplectic manifold is a $2n$ -manifold M equipped with $\omega \in A_{DR}^2(M)$ satisfying $d\omega = 0$ and $\omega_x^n \neq 0, x \in M$. Thus Kähler manifolds are symplectic.

Now let $X = N_{\mathbb{Z}} \setminus N$ be the manifold constructed out of the 3×3 upper triangular matrices as described in Example 2. The Lie algebra of N has the basis h_1, h_2, h_3 , with h_3 central and $[h_1, h_2] = h_3$. Thus the minimal Sullivan model constructed in Example 2 has the form $(\Lambda(x, y, z), d)$ with $dx = dy = 0, dz = x \wedge y$ and x, y, z of degree 1. Note that this is not formal (as is already observed in [107]; p261) since the algebra $H^*(X; \mathbb{R})$ is not generated by $H^1(X; \mathbb{R})$. (See also Benson and Gordon [23], Cordero, Fernandez and Gray [39], Félix [50], Félix and Halperin [53], Lupton and Oprea [114], Hasegawa [88])

Put $M = X \times X$. Then the inclusion

$$(\Lambda(x, y, z), d) \otimes (\Lambda(x', y', z'), d) \xrightarrow{\cong} A_{DR}(M)$$

is a minimal Sullivan model for M . Hence, as above, M is not formal. Let ω be the image in $A_{DR}^2(M)$ of the cocycle $x \wedge x' + y \wedge z + y' \wedge z'$. Since $\omega^3 \neq 0$ and ω^3 is left $N \times N$ -invariant it follows that ω^3 is not zero at any point of M . Hence (M, ω) is a non-formal symplectic manifold. □

Recently I.K. Babenko and I.A. Taimanov, [17], have constructed for any $n \geq 5$ infinitely many pairwise non homotopy equivalent non formal simply connected symplectic manifolds of dimension $2n$. In fact, as proved, by S.A. Merkulov, [124], a symplectic $2n$ -manifold M is formal if the de Rham cohomology of M satisfies the hard Lefschetz condition: i.e. the cup product $[\omega^k] : H^{n-k}(M; \mathbb{R}) \rightarrow H^{n+k}(M; \mathbb{R})$ is an isomorphism for any $k \leq n$.

Exercises

1. Let $(\Lambda V, d)$ be a Sullivan model of $S^2 \vee S^3$. Prove that there exists a quasi-isomorphism $\varphi : (\Lambda V, d) \rightarrow H^*(S^2 \vee S^3; \mathbb{Q})$. (Cf. d)-example 7). Determine the restriction of d to V^n for $n \leq 6$.
2. Prove that if X and Y are formal spaces so are $X \vee Y, X \times Y, X \wedge Y$ and $X * Y$. Determine the minimal Sullivan models of $S^8 \times \mathbb{C}P^6, S^8 \wedge \mathbb{C}P^6$ and of $S^8 * \mathbb{C}P^6$.

3. Let (A, d_A) be any commutative graded algebra and $(\wedge Z, d) \rightarrow H(A, d_A)$ a bigraded model as defined in f)-example 7. Prove that there exist a differential D and a quasi-isomorphism $\varphi : (\wedge Z, D) \rightarrow (A, d_A)$ such that $D = D_1 + D_2 + \dots + D_l + \dots$ with $D_i Z_p^n \subset (\wedge Z)_{p-i}^{n+1}$ and $D_1 = d$. (see [86].)

4. Construct a surjective quasi-isomorphism

$$(\wedge(v_2, v_4, w_2, w_4, x_1, x_3, x_5, x_7), d) \rightarrow (\wedge(y_2, y_4, z_5, z_7), \hat{d})$$

with $dv_{2i} = 0 = dw_{2j}$, $dx_1 = v_2 + w_2$, $dx_3 = v_4 + w_4 + v_2 w_2$, $dx_5 = v_4 w_2 + v_2 w_4$, $dx_7 = v_4 w_4$, $\hat{d}y_2 = 0$, $\hat{d}y_4 = 0$, $\hat{d}z_5 = y_2(2y_4 - y_2^2)$ and $\hat{d}z_7 = y_4(y_2^2 - y_4)$.

5. Let (A, d) be a commutative differential algebra and for $n \geq 1$ denote by $A(n)$ the subalgebra defined by

$$A(n)^k = \begin{cases} A^k & \text{if } k \leq n \\ dA^n & \text{if } k = n + 1 \\ 0 & \text{if } k \geq n + 2 \end{cases} .$$

Prove that if (A, d) is formal so is $(A(n), d)$. Let $(\wedge V, d)$ be a Sullivan model of a 1-connected CW complex. Construct a commutative model of the n -skeleton of X . (Cf. a)-example 6).

6. Let (A, d) be a commutative differential graded algebra and $a_i \in A^{n_i}$, $i = 0, 1, 2$, be cocycles such that $da_{12} = a_1 a_2$, $da_{23} = a_2 a_3$. Prove that $(-1)^{\deg a_1} a_1 a_{23} - a_{12} a_3$ is a cocycle; its cohomology class (which depends on the choice of a_{12} and a_{23}) is called a *Massey product*. Construct a non zero Massey product in the cohomology of the minimal model $(\wedge(a_6, a_{10}, b_{11}, b_{15}, b_{19}), d)$ such that $db_{11} = a_6^2$, $db_{15} = a_6 a_{10}$, $db_{19} = a_{10}^2$. Using the bigraded model of d)-example 7 prove that a formal space does not admit non trivial Massey products.

7. Let $(\wedge V, d)$ be a Sullivan minimal model and $\varphi, \psi : (\wedge V, d) \rightarrow (A, d)$ two morphisms of commutative differential graded algebras. Assume that for any $n \geq 1$, the restrictions of φ and ψ to $(\wedge V^{\leq n}, d)$ are homotopic. Prove that φ and ψ are homotopic. *There are no phantom maps in rational homotopy theory!*

8. Let M and N be compact connected oriented n -dimensional manifolds. Prove that if M and N are formal so is the connected sum $M \# N$ (see §11-exercise 3). Compute the minimal model of $(S^3 \times S^3) \# \mathbb{C}P^3$ up to dimension 12.

13 Adjunction spaces, homotopy groups and Whitehead products

In this section, the ground ring is a field \mathbb{k} of characteristic zero.

In applying Sullivan models it is important to be able to compute directly the models of geometric constructions from models for the spaces used in the construction. For example, in §12 we saw that the tensor product of models was a model of the topological product, while in §14 we will see how to model fibrations.

A topological pair (Z, Y) and a continuous map $f : Y \rightarrow X$ determine the topological pair $(X \cup_f Z, X)$ in which $X \cup_f Z$ is the adjunction space obtained by attaching Z to X along f . These define the commutative square

$$\begin{array}{ccc}
 Y & \xrightarrow{i} & Z \\
 f \downarrow & & \downarrow f_Z \\
 X & \xrightarrow{i_X} & X \cup_f Z .
 \end{array} \tag{13.1}$$

Analogously, if

$$(C, d) \xrightarrow{\varphi} (B, d) \xleftarrow{\psi} (A, d)$$

are morphisms of commutative cochain algebras then the fibre product $(C \times_B A, d)$ fits in the commutative fibre product square

$$\begin{array}{ccc}
 (B, d) & \xleftarrow{\psi} & (A, d) \\
 \varphi \uparrow & & \uparrow \varphi_A \\
 (C, d) & \xleftarrow{\psi_C} & (C \times_B A, d),
 \end{array} \tag{13.2}$$

and ψ_C is surjective if ψ is. Note that in (3.1) we have $Z/Y = X \cup_f Z/X$ while in (3.2) we have $\ker \psi = \ker \psi_C$. If (Z, Y) is a relative CW complex then the first equality implies (by the Cellular chain models theorem 4.18) that $H_*(Z, Y; \mathbb{k}) \xrightarrow{\cong} H_*(X \cup_f Z, X; \mathbb{k})$.

Our first objective in this section is to show that

- Suppose φ and ψ are Sullivan representatives for f and for i and one of φ, ψ is surjective. If $H_*(Z, Y; \mathbb{k}) \xrightarrow{\cong} H_*(X \cup_f Z; \mathbb{k})$ then $(C \times_B A, d)$ is a commutative model for $X \cup_f Z$.

Thus a Sullivan model for the adjunction space may be computed directly from the Sullivan representatives φ and ψ of f and i , provided that ψ is surjective. We shall then construct particular commutative models for the geometric constructions: *cone attachments, cell attachments and suspensions*.

Next, suppose $(\Lambda V, d)$ is a minimal Sullivan model for a simply connected topological space X . Our second objective in this section is to construct a natural linear map

$$\nu_X : V \rightarrow \text{Hom}(\pi_*(X), \mathbb{k})$$

and then to use the model of a cell attachment to show that:

- ν_X transforms the quadratic part of the differential in ΛV to the dual of the Whitehead product in $\pi_*(X)$.

Later (§15) we shall show that under mild hypotheses ν_X is an isomorphism, so that this transformation is in fact an identification.

This section is organized into the following topics:

- (a) Morphisms and quasi-isomorphisms.
- (b) Adjunction spaces.
- (c) Homotopy groups.
- (d) Cell attachments.
- (e) Whitehead products and the quadratic part of the differential.

(a) Morphisms and quasi-isomorphisms.

Morphisms $(C, d) \xrightarrow{\varphi} (B, d) \xleftarrow{\psi} (A, d)$ of commutative cochain algebras fit into the *fibre product square*

$$\mathcal{D} : \begin{array}{ccc} (B, d) & \longleftarrow & (A, d) \\ \uparrow & & \uparrow \\ (C, d) & \longleftarrow & (C \times_B A, d) \end{array},$$

and a commutative diagram

$$\begin{array}{ccccc} (C, d) & \xrightarrow{\varphi} & (B, d) & \xleftarrow{\psi} & (A, d) \\ \downarrow \gamma & & \downarrow \beta & & \downarrow \alpha \\ (C', d) & \xrightarrow{\varphi'} & (B', d) & \xleftarrow{\psi'} & (A', d) \end{array}$$

extends by $(\gamma, \alpha) : (C \times_B A, d) \rightarrow (C' \times_{B'} A', d)$ to a commutative cube connecting the corresponding fibre squares. We shall require

Lemma 13.3 *If γ, β, α are quasi-isomorphisms and if one of φ, ψ and one of φ', ψ' are surjective then $(\gamma, \alpha) : (C \times_B A, d) \rightarrow (C' \times_{B'} A', d)$ is a quasi isomorphism.*

proof: If ψ and ψ' are both surjective then α restricts to a quasi-isomorphism $\ker \psi \xrightarrow{\cong} \ker \psi'$. Now use the row exact diagram

$$\begin{array}{ccccccc}
 0 & \longrightarrow & \ker \psi & \longrightarrow & C \times_B A & \longrightarrow & C \longrightarrow 0 \\
 & & \cong \downarrow & & \downarrow (\gamma, \alpha) & & \downarrow \cong \\
 0 & \longrightarrow & \ker \psi' & \longrightarrow & C' \times_{B'} A' & \longrightarrow & C' \longrightarrow 0
 \end{array}$$

to conclude that (γ, α) is an isomorphism.

The other case to consider is that φ' and ψ are surjective. As in §12(b) choose a surjective commutative cochain algebra morphism $\sigma : (E, \delta) \rightarrow (B', d)$ with $H(E) = \mathbb{k}$, and consider

$$\begin{array}{ccccc}
 C' & \xrightarrow{\varphi'} & B' & \xleftarrow{\psi'} & A' \\
 & & \swarrow \varphi' \cdot \sigma & & \downarrow \lambda \\
 & & & & A' \otimes E
 \end{array}$$

The argument above shows that $(\gamma, \lambda\alpha) : (C \times_B A, d) \rightarrow (C' \times_{B'} (A' \otimes E), d)$ is a quasi-isomorphism. Since φ' is surjective the same argument shows that $(id, \lambda) : (C' \times_{B'} A', d) \rightarrow (C' \times_{B'} (A' \otimes E), d)$ is a quasi-isomorphism. Hence so is (γ, α) . □

In general a commutative cube

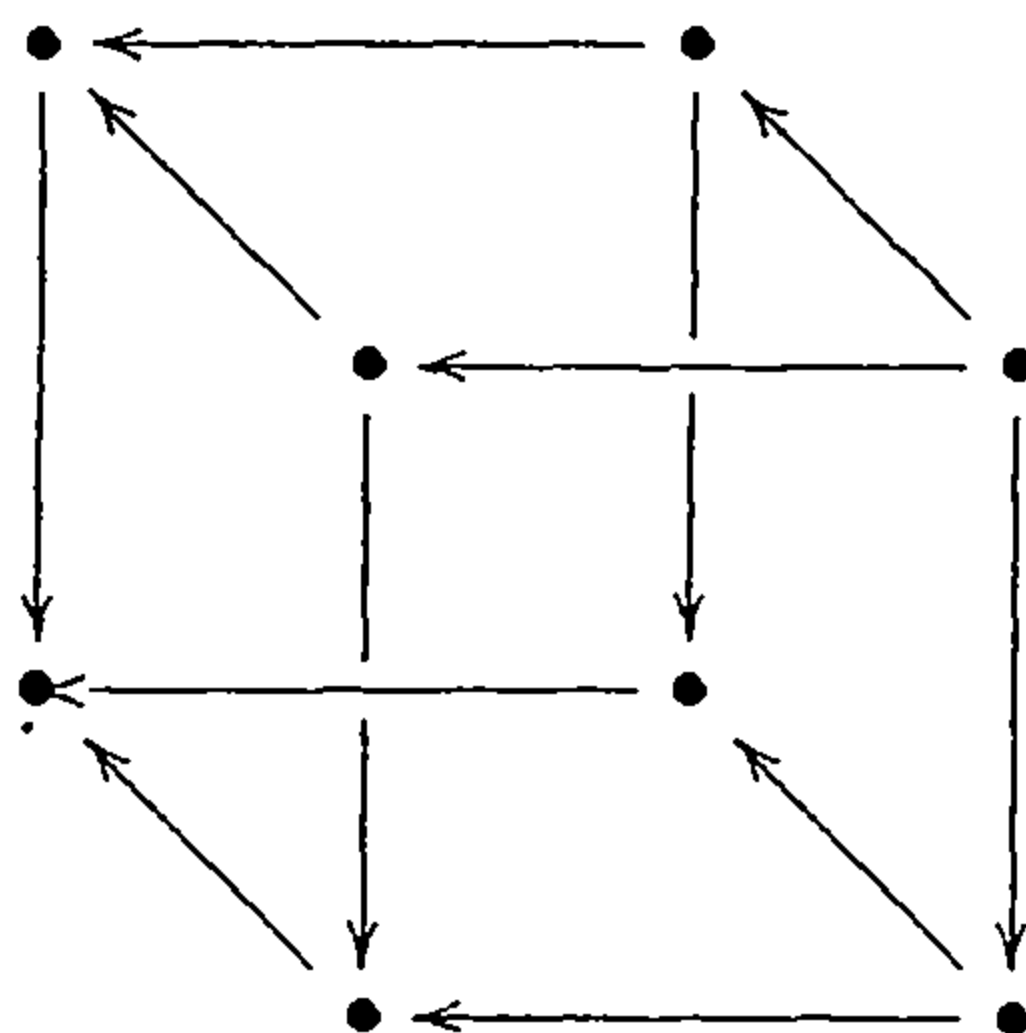

of morphisms of commutative cochain algebras will be regarded as a morphism $\mathcal{D} \rightarrow \mathcal{D}'$ from the top square to the bottom one. If the vertical arrows are all quasi-isomorphisms this is called a *quasi-isomorphism of squares* and written $\mathcal{D} \xrightarrow{\cong} \mathcal{D}'$. Two commutative squares connected by a chain $\bullet \xrightarrow{\cong} \bullet \xleftarrow{\cong} \bullet \dots \bullet \xleftarrow{\cong} \bullet$ of quasi-isomorphisms are called *weakly equivalent* (as already defined at the end of §7). Thus the conclusion of Lemma 13.3 asserts that (γ, α) defines a quasi-isomorphism between the two fibre product squares.

Next consider a homotopy commutative diagram

$$\begin{array}{ccccc}
 (\Lambda V, d) & \xrightarrow{\varphi} & (B, d) & \xleftarrow{\psi} & (\Lambda W, d) \\
 \downarrow \gamma & & \downarrow \beta & & \downarrow \alpha \\
 (C, d) & \xrightarrow{\xi} & (G, d) & \xleftarrow{\eta} & (F, d)
 \end{array}$$

of morphisms of commutative cochain algebras, in which $(\Lambda V, d)$ and $(\Lambda W, d)$ are Sullivan algebras.

Lemma 13.4 *Suppose α, β, γ are quasi-isomorphisms and that one of φ and ψ and one of ξ and η are surjective. Then the fibre squares corresponding to φ, ψ and to ξ, η are weakly equivalent.*

proof: For definiteness take ψ to be surjective. Suppose first that both ξ and η are surjective. Then we construct morphisms $\alpha' \sim \alpha$ and $\gamma' \sim \gamma$ such that replacing α by α' and γ by γ' makes the diagram above commutative. Thus in this case the Lemma follows from Lemma 13.3.

To construct α' , let $\Psi : (\Lambda W, d) \rightarrow (G, d) \otimes \Lambda(t, dt)$ be a homotopy from $\beta\psi$ to $\eta\alpha$: $\varepsilon_0\Psi = \beta\psi$ and $\varepsilon_1\Psi = \eta\alpha$, as described in §12(b). Use ε_1 to form the fibre product $G \otimes \Lambda(t, dt) \times_G E$. Then, in the diagram of cochain algebra morphisms

$$\begin{array}{ccc}
 & & F \otimes \Lambda(t, dt) \\
 & & \downarrow (\eta \otimes id, \varepsilon_1) \\
 (\Lambda W, d) & \xrightarrow{(\Phi, \alpha)} & G \otimes \Lambda(t, dt) \times_G F,
 \end{array}$$

the vertical arrow is a surjective quasi-isomorphism. Use the Lifting lemma 12.4 to lift (Φ, α) to $\Psi : (\Lambda W, d) \rightarrow F \otimes \Lambda(t, dt)$, and set $\alpha' = \varepsilon_0\Psi$. The morphism γ' is constructed in the same way.

Finally suppose ξ (for definiteness) is not surjective. Use the surjective trick (§12(b)) to extend ξ to a surjection $\xi \cdot \sigma : (C, d) \otimes (E, \delta) \rightarrow (G, d)$, with $H(E, \delta) = k$. Then the fibre square for $\xi \cdot \sigma$ and η is weakly equivalent to the fibre square for ξ, η by Lemma 13.3 and weakly equivalent to the fibre square for φ, ψ by the argument above. □

(b) Adjunction spaces.

Suppose that $i : Y \rightarrow Z$ is the inclusion of a topological pair (Z, Y) , and that

$f : Y \rightarrow X$ is any continuous map. Then we have the commutative square

$$\begin{array}{ccc}
 Y & \xrightarrow{i} & Z \\
 \downarrow f & & \downarrow fz \\
 X & \xrightarrow{i_X} & X \cup_f Z
 \end{array}
 , \text{ and the commutative model }
 \mathcal{D} :
 \begin{array}{ccc}
 A_{PL}(Y) & \longleftarrow & A_{PL}(Z) \\
 \uparrow & & \uparrow \\
 A_{PL}(X) & \longleftarrow & A_{PL}(X \cup_f Z)
 \end{array}$$

The square \mathcal{D} determines the morphism

$$(A_{PL}(i_X), A_{PL}(fz)) : A_{PL}(X \cup_f Z) \rightarrow A_{PL}(X) \times_{A_{PL}(Y)} A_{PL}(Z)$$

which (together with the identities) defines a morphism from \mathcal{D} to the fibre product square.

Proposition 13.5 *If $H_*(Z, Y; \mathbb{k}) \xrightarrow{\cong} H_*(X \cup_f Z, X; \mathbb{k})$ then the morphism $(A_{PL}(i_X), A_{PL}(fz))$ is a quasi-isomorphism. Thus the fibre product is a commutative model for the adjunction space.*

proof: Since $H_*(Z, Y; \mathbb{k}) \xrightarrow{\cong} H_*(X \cup_f Z, X; \mathbb{k})$ it follows that $A_{PL}(X \cup_f Z, X) \xrightarrow{\cong} A_{PL}(Z, Y)$. Thus in the row exact diagram

$$\begin{array}{ccccccc}
 0 & \longrightarrow & A_{PL}(X \cup_f Z, X) & \longrightarrow & A_{PL}(X \cup_f Z) & \longrightarrow & A_{PL}(X) \longrightarrow 0 \\
 & & \cong \downarrow & & \downarrow & & \parallel \\
 0 & \longrightarrow & A_{PL}(Z, Y) & \longrightarrow & A_{PL}(X) \times_{A_{PL}(Y)} A_{PL}(Z) & \longrightarrow & A_{PL}(X) \longrightarrow 0
 \end{array}$$

the central arrow is a quasi-isomorphism. □

Proposition 13.5 replaces the geometric adjunction space by the algebraic fibre product. Using Lemma 13.4 we can now pass to Sullivan models. Thus suppose X, Y and Z are path connected, that

$m_X : (\Lambda V, d) \rightarrow A_{PL}(X)$, $m : (\Lambda U, d) \rightarrow A_{PL}(Y)$ and $m_Z : (\Lambda W, d) \rightarrow A_{PL}(Z)$ are Sullivan models and that

$$(\Lambda V, d) \xrightarrow{\varphi} (\Lambda U, d) \xleftarrow{\psi} (\Lambda W, d)$$

are Sullivan representatives for f and for i .

Proposition 13.6 *If $H_*(Z, Y; \mathbb{k}) \xrightarrow{\cong} H_*(X \cup_f Z, X; \mathbb{k})$ and if one of φ, ψ is surjective then \mathcal{D} is weakly equivalent to the fibre product square*

$$\begin{array}{ccc}
 (\Lambda U, d) & \longleftarrow & (\Lambda W, d) \\
 \uparrow & & \uparrow \\
 (\Lambda V, d) & \longleftarrow & (\Lambda V \times_{\Lambda U} \Lambda W, d) .
 \end{array}$$

In particular, $(\Lambda V \times_{\Lambda U} \Lambda W, d)$ is a commutative model for $X \cup_f Z$.

proof: This is an immediate translation of Lemma 13.4, given Proposition 13.5.

□

Now consider the very important special case of adjunction spaces given by attaching a cone. Recall that the cone on a topological space Y is the space $CY = (Y \times I)/(Y \times \{0\})$. We identify Y as the subspace $Y \times \{1\} \subset CY$. Then, given any continuous map $f : Y \rightarrow X$ we attach the cone CY to X along f to form $X \cup_f CY$.

Now, suppose X is path connected. We shall use a different technique to construct a commutative model for $X \cup_f CY$. Let $m_\alpha : (\Lambda W_\alpha, d) \xrightarrow{\cong} A_{PL}(Y_\alpha)$ be Sullivan models for the path components Y_α of Y , and put $(B, d) = \prod_{\alpha} (\Lambda W_\alpha, d)$.

Then $\prod_{\alpha} A_{PL}(Y_\alpha) = A_{PL}(Y)$ and $m = \prod_{\alpha} m_\alpha : (B, d) \xrightarrow{\cong} A_{PL}(Y)$ is a quasi-isomorphism. Let $\varphi_\alpha : (\Lambda V, d) \rightarrow (\Lambda W_\alpha, d)$ be Sullivan representatives for $f_\alpha = f|_{Y_\alpha}$ with respect to a Sullivan model $m_X : (\Lambda V, d) \rightarrow A_{PL}(X)$, and put $\varphi = (\varphi_\alpha) : (\Lambda V, d) \rightarrow (B, d)$.

Finally, as usual, let $\varepsilon_0, \varepsilon_1 : \Lambda(t, dt) \rightarrow \mathbb{k}$ be the morphisms $t \mapsto 0, 1$. Thus $\ker \varepsilon_0$ is the ideal $\Lambda^+(t, dt)$. Use the morphisms

$$(\Lambda V, d) \xrightarrow{\varphi} (B, d) \xleftarrow{id \otimes \varepsilon_1} (\mathbb{k} \oplus [B \otimes \Lambda^+(t, dt)], d) \quad (13.7)$$

to construct the fibre product $\Lambda V \times_B (\mathbb{k} \oplus [B \otimes \Lambda^+(t, dt)])$.

Proposition 13.8 *The fibre product square for (13.7) is weakly equivalent to the commutative adjunction space for $X \cup_f CY$. In particular the cochain algebra $\Lambda V \times_B (\mathbb{k} \oplus [B \otimes \Lambda^+(t, dt)])$ is a commutative model for $X \cup_f CY$.*

proof: Use Proposition 13.5 to identify $A_{PL}(X) \times_{A_{PL}(Y)} A_{PL}(CY)$ as a commutative model for $X \cup_f CY$. Let i_1 denote the inclusion $y \mapsto (y, 1)$ of Y in CY and in $Y \times I$ and also of $\{1\}$ in I , and notice that the chain of quasi-isomorphisms

$$A_{PL}(CY, pt) \xrightarrow{\cong} A_{PL}(Y \times I, Y \times \{0\}) \xleftarrow{\cong} A_{PL}(Y) \otimes A_{PL}(I, \{0\})$$

is compatible with the surjections $A_{PL}(i_1)$ and $id \otimes A_{PL}(i_1)$. Regard the identity of I as a 1-simplex. Restriction to this simplex is a quasi-isomorphism $A_{PL}(I, \{0\}) \rightarrow \Lambda^+(t, dt)$ which converts $id \otimes A_{PL}(i_1)$ to $id \otimes \varepsilon_1$. Since $A_{PL}(CY) = \mathbb{k} \oplus A_{PL}(CY, pt)$ we obtain a chain of quasi-isomorphisms connecting $A_{PL}(X) \times_{A_{PL}(Y)} A_{PL}(CY)$ with $A_{PL}(X) \times_{A_{PL}(Y)} (\mathbb{k} \oplus [A_{PL}(Y) \otimes \Lambda^+(t, dt)])$.

On the other hand, there are homotopics $m_\alpha \varphi_\alpha \sim A_{PL}(f_\alpha) m_X$. A choice of

these defines a commutative diagram

$$\begin{array}{ccccc}
 A_{PL}(X) & \xleftarrow[m_X \cong]{} & (\Lambda V, d) & & \\
 \downarrow A_{PL}(f) & & \swarrow & \downarrow m_Y & \searrow \varphi \\
 A_{PL}(Y) & \xleftarrow[\varepsilon_1]{\cong} & \prod_{\alpha} (A_{PL}(Y_{\alpha}) \otimes \Lambda(t, dt)) & \xrightarrow[\varepsilon_0]{\cong} & A_{PL}(Y) & \xleftarrow[m]{\cong} & (B, d)
 \end{array}$$

and this connects $A_{PL}(X) \times_{A_{PL}(Y)} (\mathbb{k} \oplus [A_{PL}(Y) \otimes \Lambda^+(t, dt)])$ to $\Lambda V \times_B (\mathbb{k} \oplus [B \otimes \Lambda^+(t, dt)])$ by a chain of quasi-isomorphisms too. □

As a special case of Proposition 13.8 we prove

Proposition 13.9 *The suspension, ΣY , of a well-based topological space (Y, y_0) is formal, and satisfies $H^+(\Sigma Y; \mathbb{k}) \cdot H^+(\Sigma Y; \mathbb{k}) = 0$.*

proof: Apply Proposition 13.8 to the case of the constant map $f : Y \rightarrow \{pt\}$ to obtain a commutative model for $\{pt\} \cup_f CY$ of the form $\mathbb{k} \times_B (\mathbb{k} \oplus [B \otimes \Lambda^+(t, dt)])$. But this is just the cochain algebra $\mathbb{k} \oplus [B \otimes J]$, where $J = \ker \varepsilon_1 \cap \Lambda^+(t, dt)$.

Now J is the ideal generated by $t(1-t)$ and dt and thus the inclusion $\mathbb{k}dt \rightarrow J$ is a quasi-isomorphism. It follows that $\mathbb{k} \oplus [B \otimes dt]$ includes quasi-isomorphically in $\mathbb{k} \oplus [B \otimes J]$. Let $H \subset B \otimes dt$ be any subspace of cocycles mapping isomorphically to $H(B \otimes dt)$. Since $(B \otimes dt) \cdot (B \otimes dt) \subset B \otimes (dt \wedge dt) = 0$, the inclusion $(\mathbb{k} \oplus H, 0) \rightarrow \mathbb{k} \oplus [B \otimes J]$ is a cochain algebra quasi-isomorphism, exhibiting $\mathbb{k} \oplus H$ as a commutative model for $\{pt\} \cup_f CY$ in which $H \cdot H = 0$.

Finally, $\{pt\} \cup_f CY = CY / (Y \times \{1\})$, which is homotopy equivalent to ΣY since (Y, y_0) is well-based (§1(d)). □

(c) Homotopy groups.

Suppose $f : (Y, *) \rightarrow (X, *)$ is a continuous map between simply connected topological spaces. Recall that a choice of minimal Sullivan models,

$$m_X : (\Lambda V, d) \xrightarrow{\cong} A_{PL}(X) \quad \text{and} \quad m_Y : (\Lambda W, d) \xrightarrow{\cong} A_{PL}(Y)$$

determines a unique homotopy class of morphisms $\varphi_f : (\Lambda V, d) \rightarrow (\Lambda W, d)$ such that $A_{PL}(f)m_X = m_Y\varphi_f$. Moreover, Proposition 12.8(ii) asserts that these Sullivan representatives of f all have the same linear part: $Q(\varphi_f)$ is independent of the choice of φ_f . This will therefore be denoted by

$$Q(f) : V \rightarrow W.$$

Note that (Proposition 12.6) $Q(f)$ only depends on the homotopy class of f .

We use this construction to define a natural pairing, $\langle ; \rangle$ between V and $\pi_*(X)$, depending only on the choice of $m_X : (\Lambda V, d) \rightarrow A_{PL}(X)$.

First, recall the minimal Sullivan models $m_k : (\Lambda(e), 0) \rightarrow A_{PL}(S^k)$, k odd, and $m_k : (\Lambda(e, e'), de' = e^2) \rightarrow A_{PL}(S^k)$, k even, as constructed in Example 1,

§12(a). Because $H^*(S^k; \mathbb{k})$ is so simple, the morphisms m_k are determined up to homotopy by the condition $\langle H^*(m_k)[e], [S^k] \rangle = 1$, where $[S^k]$ is the fundamental class defined in §4(c) and $\langle \ , \ \rangle$ denotes the pairing between cohomology and homology (§5).

Now suppose $\alpha \in \pi_k(X)$ is represented by $a : (S^k, *) \rightarrow (X, *)$. Then $Q(a) : V^k \rightarrow \mathbb{k} \cdot e$ depends only on α and the choice of the morphism $m_X : (\Lambda V, d) \rightarrow A_{PL}(X)$. Define the pairing

$$\langle -; - \rangle : V \times \pi_*(X) \rightarrow \mathbb{k} \quad (13.10)$$

by the equations

$$\langle v; \alpha \rangle e = \begin{cases} Q(a)v & , v \in V^k, \\ 0 & , \deg v \neq \deg \alpha . \end{cases}$$

It is immediate from the definition that for $f : (Y, *) \rightarrow (X, *)$ as above,

$$\langle Q(f)v; \beta \rangle = \langle v; \pi_*(f)\beta \rangle, \quad v \in V, \beta \in \pi_*(Y).$$

Lemma 13.11 *The map $\langle -; - \rangle$ is bilinear.*

proof: The linearity in V is immediate from the definition. To show linearity in $\pi_*(X)$, consider the space $S^k \vee S^k$. Let i_0, i_1 be the inclusions of the left and right spheres and let $j : (S^k, *) \rightarrow (S^k \vee S^k, *)$ satisfy $[j] = [i_0] + [i_1]$ in $\pi_k(S^k \vee S^k)$. The linear maps $Q(i_0)$, $Q(i_1)$ and $Q(j)$ can be computed as follows. Let w_0, w_1 be the basis for $H^k(S^k \vee S^k; \mathbb{k})$ defined by $\langle w_0, H_*(i_0)[S^k] \rangle = 1 = \langle w_1, H_*(i_1)[S^k] \rangle$ and $\langle w_0, H_*(i_1)[S^k] \rangle = 0 = \langle w_1, H_*(i_0)[S^k] \rangle$. Then a minimal Sullivan model for $S^k \vee S^k$ is given by

$$m : (\Lambda(e_0, e_1, \dots), d) \xrightarrow{\cong} A_{PL}(S^k \vee S^k)$$

where e_0, e_1 are cocycles of degree k , the remaining generators have greater degree, and $H(m)[e_\lambda] = \omega_\lambda$, $\lambda = 0, 1$.

Thus a Sullivan representative φ_0 for i_0 satisfies $H(\varphi_0)[e_0] = [e]$ and $H(\varphi_0)[e_1] = 0$. Since the models have no coboundaries in degree k this implies $\varphi_0 e_0 = e$ and $\varphi_0 e_1 = 0$; i.e. $Q(i_0)e_0 = e$ and $Q(i_0)e_1 = 0$. In the same way it follows that $Q(i_1)e_1 = 0$ and $Q(i_1)e_1 = e$ and $Q(j)e_0 = e = Q(j)e_1$. Now let α_0, α_1 represent $\alpha_0, \alpha_1 \in \pi_k(X)$. Then $\alpha_0 + \alpha_1$ is represented by

$$a : S^k \xrightarrow{j} S^k \vee S^k \xrightarrow{(a_0, a_1)} X.$$

We just computed $Q(i_0)$, $Q(i_1)$ and $Q(j)$. Since $(a_0, a_1) \circ i_0 = a_0$ and $(a_0, a_1) \circ i_1 = a_1$, it is immediate from these computations that $Q(a_0, a_1)v = \langle v; \alpha_0 \rangle e_0 + \langle v; \alpha_1 \rangle e_1$, and so $Q(a)v = (\langle v; \alpha_0 \rangle + \langle v; \alpha_1 \rangle)e$, as desired. \square

Lemma 13.11 shows that $\langle -; - \rangle$ induces a natural linear map

$$\nu_X : V \longrightarrow \text{Hom}_{\mathbb{Z}}(\pi_*(X), \mathbb{k}), \quad v \mapsto \langle v; - \rangle.$$

In §15 we shall show that if $H_*(X; \mathbb{Q})$ has finite type then this map is a linear isomorphism.

Finally, recall that $m_X : (\Lambda V_X, d) \rightarrow A_{PL}(X)$ denotes the minimal Sullivan model of our simply connected topological space X . On the one hand we have the Hurewicz homomorphism $hur_X : \pi_*(X) \rightarrow H_*(X; \mathbb{Z})$. On the other, since $\text{Im } d \subset \Lambda^{\geq 2} V_X$, division by $\Lambda^{\geq 2} V_X$ defines a linear map $\zeta : H^+(\Lambda V_X) \rightarrow V_X$. It is immediate from the definition that

$$\langle \zeta[z]; \alpha \rangle = \langle H(m_X)[z], hur_X(\alpha) \rangle \quad \begin{array}{l} [z] \in H^+(\Lambda V_X, d) \\ \alpha \in \pi_*(X). \end{array}$$

Thus the diagram

$$\begin{array}{ccc} H^+(\Lambda V_X) & \xrightarrow[\cong]{H(m_X)} & H^*(X; \mathbb{k}) \\ \downarrow \zeta & & \downarrow hur_X^* \\ V_X & \xrightarrow{\nu_X} & \text{Hom}(\pi_*(X), \mathbb{k}) \end{array}$$

commutes, where hur_X^* is the dual of hur_X .

(d) Cell attachments.

Fix a continuous map

$$a : (S^n, *) \rightarrow (X, *), \quad n \geq 1,$$

into a simply connected topological space X , representing $\alpha \in \pi_n(X)$. The space $X \cup_a D^{n+1}$ is the space obtained by attaching an $(n+1)$ -cell to X along a . Now choose a minimal Sullivan model

$$m_X : (\Lambda V, d) \xrightarrow{\cong} A_{PL}(X).$$

Our objective is to use this, and the pairing $\langle -; - \rangle : V \times \pi_*(X) \rightarrow \mathbb{k}$, to construct a commutative model for $X \cup_a D^{n+1}$.

If $n = 1$ then $X \cup_a D^2 \simeq X \vee S^2$, because a will be based homotopic to the constant map. In this case the discussion of wedges in §12(c) shows that $X \cup_a D^2$ has a commutative model of the form $(\Lambda V \oplus \mathbb{k}u, d)$ in which $\deg u = 2$, $(\Lambda V, d)$ is a sub cochain algebra, $u \cdot \Lambda^+ V = 0 = u^2$, and $du = 0$.

For $n \geq 2$ define a commutative cochain algebra $(\Lambda V \oplus \mathbb{k}u, d_\alpha)$ by:

- $\deg u = n + 1$.
- ΛV is a subalgebra and $u \cdot \Lambda^+ V = 0 = u^2$.
- $d_\alpha u = 0$ and $d_\alpha v = dv + \langle v; \alpha \rangle u, v \in V$.

Note that $d_\alpha z = dz$ if $z \in \Lambda^{\geq 2}V$ because d_α is a derivation.

Proposition 13.12 *The cochain algebra $(\Lambda V \oplus ku, d_\alpha)$ is a commutative model for $X \cup_a D^{n+1}$.*

proof: We apply Proposition 13.8, noting that $D^{n+1} = CS^n$. This gives a commutative model for $X \cup_a D^{n+1}$ of the form $\Lambda V \times_{\Lambda W} (\mathbb{k} \oplus [\Lambda^+ W \otimes \Lambda^+(t, dt)])$, where $(\Lambda W, d)$ is the minimal Sullivan model for S^n (Example 1, §12(a)). The quasi-isomorphism $(\Lambda W, d) \rightarrow (H(S^n), 0)$ then defines a quasi-isomorphism $\Lambda V \times_{\Lambda W} (\mathbb{k} \oplus [\Lambda^+ W \otimes \Lambda^+(t, dt)]) \xrightarrow{\cong} \Lambda V \times_{H(S^n)} (\mathbb{k} \oplus [H^+(S^n) \otimes \Lambda^+(t, dt)])$.

These constructions are made using a Sullivan representative $\varphi_a : (\Lambda V, d) \rightarrow (\Lambda W, d)$ for a . Let φ be the composite of φ_a with $\bar{m} : (\Lambda W, d) \xrightarrow{\cong} H(S^n)$ and define a linear inclusion λ of ΛV into the fibre product by

$$\lambda(1) = 1 \quad \text{and} \quad \lambda\Phi = (\Phi, \varphi\Phi \otimes t), \quad \Phi \in \Lambda^+ V .$$

Now $H^+(S^n) = \mathbb{k}[e]$, where $[e]$ is dual to the fundamental class $[S^n]$. Hence $\lambda\Phi = (\Phi, 0)$ if $\Phi \in \Lambda^{\geq 2}V$ or if $\Phi \in V^k, k \neq n$. Moreover, for $v \in V^n$,

$$\lambda v = (v, \langle v; \alpha \rangle [e] \otimes t) .$$

It follows at once that λ is an algebra morphism and that it can be extended to a cochain algebra morphism

$$(\Lambda V \oplus ku, d_\alpha) \rightarrow \Lambda V \times_{H(S^n)} (\mathbb{k} \oplus [H^+(S^n) \otimes \Lambda^+(t, dt)])$$

by defining $u \mapsto (-1)^n [e] \otimes dt$. It is a trivial verification that this is a quasi-isomorphism. □

Remark In the situation of Proposition 13.12, consider the commutative square of continuous maps,

$$\begin{array}{ccc} X \cup_a D^{n+1} & \xleftarrow{j_X} & X \\ \uparrow a_D & & \uparrow a \\ D^{n+1} & \xleftarrow{j} & S^n \end{array} \tag{13.13}$$

This diagram determines the row exact diagram

$$\begin{array}{ccccccc} 0 & \longrightarrow & A_{PL}(X \cup_a D^{n+1}, X) & \longrightarrow & A_{PL}(X \cup_a D^{n+1}) & \longrightarrow & A_{PL}(X) \longrightarrow 0 \\ & & \downarrow & & \downarrow A_{PL}(a_D) & & \downarrow A_{PL}(a) \\ 0 & \longrightarrow & A_{PL}(D^{n+1}, S^n) & \longrightarrow & A_{PL}(D^{n+1}) & \longrightarrow & A_{PL}(S^n) \longrightarrow 0 \end{array} \tag{13.14}$$

The proofs of Propositions 13.8 and 13.12 show that this is connected by a chain of quasi-isomorphisms to the diagram

$$\begin{array}{ccccccc}
 0 & \longrightarrow & \mathbb{K}u & \longrightarrow & (\Lambda V \oplus \mathbb{K}u, d_\alpha) & \longrightarrow & (\Lambda V, d) \longrightarrow 0 \\
 & & \downarrow = & & \downarrow \beta & & \downarrow \overline{m}\varphi_\alpha \\
 0 & \longrightarrow & \mathbb{K}u & \xrightarrow{\lambda} & \mathbb{K} \oplus \mathbb{K}w \oplus \mathbb{K}dw & \xrightarrow{e} & H^*(S^n; \mathbb{K}) \longrightarrow 0,
 \end{array} \tag{13.15}$$

in which:

$$\lambda u = dw, \quad \beta u = dw, \quad \beta v = \langle v; \alpha \rangle w, \quad \text{and} \quad \langle \varrho w, [S^n] \rangle = 1.$$

(e) The Whitehead product and the quadratic part of the differential.

Let X be a path connected topological space. The Whitehead product is a map

$$[,]_W : \pi_k(X) \times \pi_n(X) \longrightarrow \pi_{k+n-1}(X).$$

We define it now and then show how, if X is simply connected, to read it off from the differential in a minimal Sullivan model.

Recall that in Example 5, §1, homeomorphisms $I^k / \partial I^k \xrightarrow{\cong} S^k$ and $\partial I^{k+1} \xrightarrow{\cong} S^k$ are specified for $k \geq 1$. Regard the first homeomorphism as a continuous map $a_k : (I^k, \partial I^k) \longrightarrow (S^k, *)$. Thus

$$a_k \times a_n : (I^{k+n}, \partial I^{k+n}, y_0) \longrightarrow (S^k \times S^n, S^k \vee S^n, *), \quad y_0 = (1, 1, \dots, 1).$$

Use the second homeomorphism to identify $a_k \times a_n |_{\partial I^{k+n}}$ as a continuous map

$$a_{k,n} : (S^{k+n-1}, x_0) \longrightarrow (S^k \vee S^n, *), \quad x_0 = \left(\frac{1}{\sqrt{k+n}}, \dots, \frac{1}{\sqrt{k+n}} \right).$$

The homotopy class $[a_{k,n}] \in \pi_{k+n-1}(S^k \vee S^n)$ is called the *universal (k, n)-Whitehead product*. (This is actually an abuse of language. The map $a_{k,n}$ must be precomposed with an orientation-preserving rotation sending $*$ to x_0 . However any two such relations are based homotopic, so the based homotopy class of the composite depends only on $a_{k,n}$.)

When $k = n = 1$ the picture

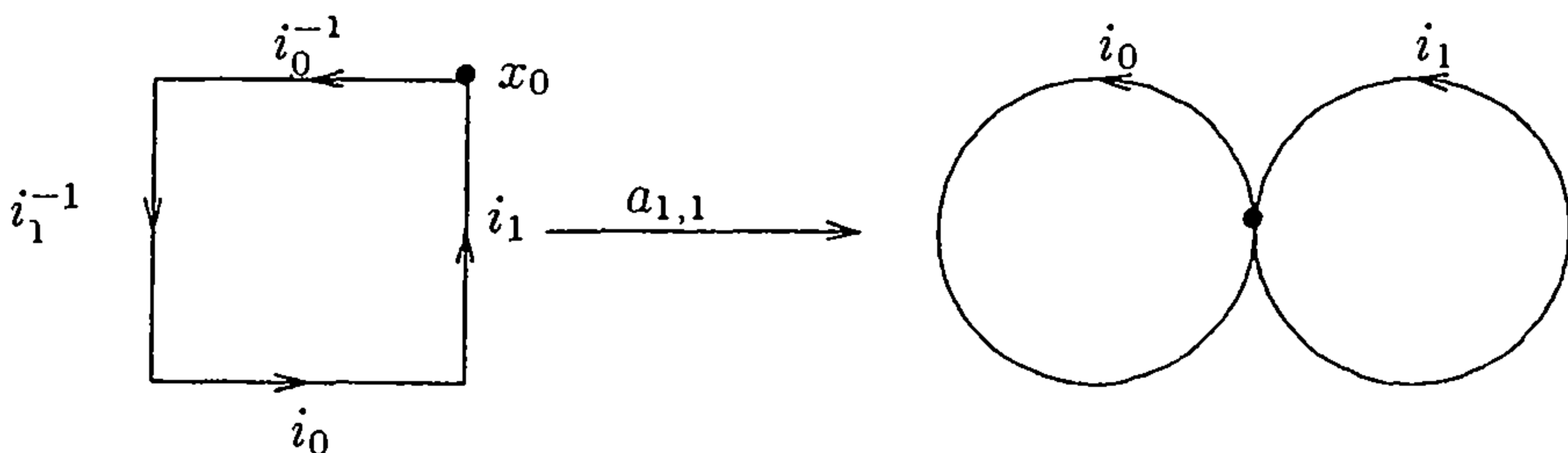

identifies $[a_{1,1}]$ as the commutator $[i_0]^{-1}[i_1]^{-1}[i_0][i_1]$.

Definition The *Whitehead product* of $\gamma_0 \in \pi_k(X)$ and $\gamma_1 \in \pi_n(X)$ is the homotopy class $[\gamma_0, \gamma_1]_W \in \pi_{k+n-1}(X)$ represented by the map

$$[c_0, c_1]_W : S^{k+n-1} \xrightarrow{\alpha_{k,n}} S^k \vee S^n \xrightarrow{(c_0, c_1)} X,$$

where $c_0 : S^k \rightarrow X$ represents γ_0 and $c_1 : S^n \rightarrow X$ represents γ_1 .

Next, consider a minimal Sullivan algebra $(\Lambda V, d)$. The restriction of d to V decomposes as the sum of linear maps $\alpha_i : V \rightarrow \Lambda^{i+1}V, i \geq 1$. Each α_i extends uniquely to a derivation d_i of ΛV , and d_i increases wordlength by i . Moreover d decomposes as the sum $d = d_1 + d_2 + \dots$ of the derivations d_i . Clearly, d_1^2 raises wordlength by 2 and $d^2 - d_1^2$ raises wordlength by at least 3. Since $d^2 = 0$ this implies $d_1^2 = 0$; i.e.

- $(\Lambda V, d_1)$ is a minimal Sullivan algebra.

Definition d_1 is called the *quadratic part* of d .

Recall from §12(b) that the linear part of a morphism $\varphi : (\Lambda V, d) \rightarrow (\Lambda W, d)$ of Sullivan algebras is the linear map $Q(\varphi) : V \rightarrow W$ defined by $\varphi v - Q(\varphi)v \in \Lambda^{\geq 2}W$. It extends uniquely to a morphism of graded algebras, $\Lambda Q(\varphi) : \Lambda V \rightarrow \Lambda W$. If $(\Lambda V, d)$ and $(\Lambda W, d)$ are minimal then the same calculation as for d_1^2 above shows that $(\Lambda Q(\varphi)) d_1 = d_1 (\Lambda Q(\varphi))$; i.e.,

- $\Lambda Q(\varphi) : (\Lambda V, d_1) \rightarrow (\Lambda W, d_1)$ is a dga morphism between minimal Sullivan algebras.

Finally, suppose that X is a simply connected topological space, with minimal Sullivan model

$$m_X : (\Lambda V_X, d) \xrightarrow{\cong} A_{PL}(X).$$

Define a trilinear map

$$\langle ; , \rangle : \Lambda^2 V_X \times \pi_*(X) \times \pi_*(X) \rightarrow \mathbb{k}$$

by

$$\langle v \wedge w; \gamma_0, \gamma_1 \rangle = \langle v; \gamma_1 \rangle \langle w; \gamma_0 \rangle + (-1)^{\deg w \deg \gamma_0} \langle v; \gamma_0 \rangle \langle w; \gamma_1 \rangle, \quad \begin{array}{l} v, w \in V_X, \\ \gamma_0, \gamma_1 \in \pi_*(X) \end{array}$$

Proposition 13.16 *The Whitehead product in $\pi_*(X)$ is dual to the quadratic part of the differential of $(\Lambda V_X, d)$. More precisely,*

$$\langle d_1 v; \gamma_0, \gamma_1 \rangle = (-1)^{k+n-1} \langle v; [\gamma_0, \gamma_1]_W \rangle, \quad \begin{array}{l} v \in V_X, \\ \gamma_0 \in \pi_k(X), \\ \gamma_1 \in \pi_n(X). \end{array}$$

proof: For the sake of simplicity we denote the universal Whitehead product $[a_{k,n}]$ simply by $\alpha \in \pi_{k+n-1}(S^k \vee S^n)$. If $c_0 : (S^k, *) \rightarrow (X, *)$ and $c_1 : (S^n, *) \rightarrow (X, *)$ represent γ_0 and γ_1 , then put $c = (c_0, c_1) : S^k \vee S^n \rightarrow X$, so that $[\gamma_0, \gamma_1]_W = \pi_*(c)\alpha$. Hence

$$\langle v; [\gamma_0, \gamma_1]_W \rangle = \langle Q(c)v; \alpha \rangle.$$

Moreover, if $i_0 : S^k \rightarrow S^k \vee S^n$ and $i_1 : S^n \rightarrow S^k \vee S^n$ are the inclusions, then

$$\langle d_1 v; \gamma_0, \gamma_1 \rangle = \langle d_1 v; \pi_*(c)[i_0], \pi_*(c)[i_1] \rangle = \langle d_1 Q(c)v; [i_0], [i_1] \rangle.$$

It is thus sufficient to prove the proposition for $X = S^k \vee S^n$ and $\gamma_0 = [i_0]$ and $\gamma_1 = [i_1]$.

For this we require the minimal Sullivan model of $S^k \vee S^n$, at least up to degree $k + n - 1$. First, let $m_0 : (\Lambda W_0, d) \xrightarrow{\cong} A_{PL}(S^k)$ and $m_1 : (\Lambda W_1, d) \xrightarrow{\cong} A_{PL}(S^n)$ be the minimal Sullivan models of Example 1, §12(a). Thus $(\Lambda W_0, d) = (\Lambda(e_0, \dots), d)$, $(\Lambda W_1, d) = (\Lambda(e_1, \dots), d)$ and $\langle H(m_0)[e_0], [S^k] \rangle = 1 = \langle H(m_1)[e_1], [S^n] \rangle$. Let $p_0 = (id, const.) : S^k \vee S^n \rightarrow S^k$ and $p_1 = (const., id) : S^k \vee S^n \rightarrow S^n$ denote the projections. Use the construction process of Proposition 12.2 to extend the morphism $(A_{PL}(p_0)m_0) \cdot (A_{PL}(p_1)m_1) : (\Lambda W_0, d) \otimes (\Lambda W_1, d) \rightarrow A_{PL}(S^k \vee S^n)$ to a Sullivan model

$$m : (\Lambda W_0 \otimes \Lambda W_1 \otimes \Lambda(x, y_1, y_2, \dots), d) \xrightarrow{\cong} A_{PL}(S^k \vee S^n),$$

in which: $dx = e_0 \otimes e_1$ and $\deg y_i > \deg x$, $i = 1, 2, \dots$. Denote this model simply by $m : (\Lambda V, d) \rightarrow A_{PL}(S^k \vee S^n)$.

Next write $a = a_{k,n}$, so that $S^k \times S^n = (S^k \vee S^n) \cup_a (I^k \times I^n)$. The commutative square

$$\begin{array}{ccc} S^k \times S^n = (S^k \vee S^n) \cup_a (I^k \times I^n) & \xleftarrow{(p_0, p_1)} & S^k \vee S^n \\ \uparrow a_k \times a_n & & \uparrow a \\ I^k \times I^n & \xleftarrow{j} & S^{k+n-1} \end{array}$$

is precisely (13.13), where a_k and a_n are the maps defined at the start of this topic. In particular, Proposition 13.12 asserts that $(\Lambda V \oplus ku, d_a)$ is a commutative model for $S^k \times S^n$, and provides an explicit isomorphism of $H(\Lambda V \oplus ku, d_a)$ with $H^*(S^k \times S^n; \mathbb{Z})$.

We shall use this isomorphism to evaluate the classes $[e_0 e_1]$ and $[u]$ on a certain homology class, $[z]$. The identity map of I is a singular 1-simplex $\iota \in C_1(I; \mathbb{Z})$. The chain $w_k = EZ(\iota \otimes \dots \otimes \iota) \in C_k(I^k; \mathbb{Z})$ projects to a relative cycle representing $[I^k] \in H_k(I^k, \partial I^k; \mathbb{Z})$, as was observed in §4(c). Moreover, because

$a_k : \partial I_k \rightarrow \{pt\}$, and because $C_*({pt}; \mathbb{Z}) = \mathbb{Z} \cdot pt$, it follows that $C_*(a_k)w_k$ is a cycle in $C_k(S^k; \mathbb{Z})$. Define a cycle $z \in C_*(S^k \times S^n; \mathbb{Z})$ by

$$z = EZ(C_*(a_k)w_k \otimes C_*(a_n)w_n) = C_*(a_k \times a_n)w_{k+n}.$$

As observed in §4(c), the cycle $C_*(a_k)w_k$ represents $[S^k]$. Since (§4(b)) EZ and AW induce inverse isomorphisms of homology, a quick computation gives

$$\langle [e_0 \otimes e_1], [z] \rangle = \langle H(m_0)[e_0] \otimes H(m_1)[e_1], [S^k] \otimes [S^n] \rangle = (-1)^{kn}.$$

On the other hand, it follows from diagram (13.15) that $H^*(a_k \times a_n)[u] = \partial^* \omega$, where: $[u]$ is regarded as a relative cohomology class in $H^*(S^k \times S^n, S^k \vee S^n; \mathbb{k})$, $\omega \in H^{n+k-1}(S^{n+k-1}; \mathbb{k})$ is dual to $[S^{n+k-1}]$ and ∂^* is the connecting homomorphism in cohomology for the pair $(I^k \times I^n, S^{n+k-1})$. Hence

$$\langle [u], [z] \rangle = \langle [u], H_*(a_k \times a_n)[I^{k+n}] \rangle = \langle \partial^* \omega, [I^{k+n}] \rangle = (-1)^{k+n} \langle \omega, \partial[I^{k+n}] \rangle.$$

But, as observed in §4(c), $\partial[I^{k+n}] = [S^{k+n-1}]$. Thus $\langle [u], [z] \rangle = (-1)^{k+n}$.

Since $d_\alpha x = e_0 e_1 + \langle x; \alpha \rangle u$ (cf. §13(d)) it follows that $[e_0 e_1] + \langle x; \alpha \rangle [u] = 0$. Evaluate this equation at $[z]$ to find $(-1)^{kn} + (-1)^{k+n} \langle x; \alpha \rangle = 0$; i.e.

$$\langle x; \alpha \rangle = (-1)^{(k+1)(n+1)}.$$

In particular it follows that

$$\langle d_1 x; [i_0], [i_1] \rangle = \langle e_0 \otimes e_1; [i_0], [i_1] \rangle = (-1)^{kn}$$

and

$$\langle x; [[i_0], [i_1]]_W \rangle = \langle x; \alpha \rangle = (-1)^{(k+1)(n+1)}.$$

Unless $k = n$ is even, $V^{k+n-1} = \mathbb{k}x$, and this completes the proof. In the remaining case, e'_0 and e'_1 both have degree $k+n-1$. However $p_0 a : S^{k+n-1} \rightarrow S^k$ factors as $S^{k+n-1} \rightarrow I^k \times I^n \rightarrow S^k \times S^n \rightarrow S^k$, and hence is homotopic to the constant map. Thus

$$\langle e'_0; \alpha \rangle = \langle Q(p_0)e'_0; \alpha \rangle = \langle e'_0; Q(p_0)Q(a)[id_{S^{n+k-1}}] \rangle = 0$$

and

$$\langle d_1 e'_0; [i_0], [i_1] \rangle = \langle e_0^2; [i_0], [i_1] \rangle = 0.$$

The same holds for e'_1 , and so the proposition follows in this case as well. \square

Example 1 *The even spheres S^{2n} .*

Let $\alpha \in \pi_{2n}(S^{2n})$ be represented by the identity map, and recall that the minimal Sullivan model of S^{2n} has the form $(\Lambda(e, e'), de' = e^2)$. It is clear that $\langle e; \alpha \rangle = 1$, and so

$$\langle e'; [\alpha, \alpha]_W \rangle = -\langle e^2; \alpha, \alpha \rangle = -2.$$

In particular, $[\alpha, \alpha]_W$ is not a torsion class in $\pi_{4n-1}(S^{2n})$. \square

Example 2 $S^3 \vee S^3 \cup_f (D_0^8 \amalg D_1^8)$.

Let $a_0, a_1 : S^3 \rightarrow S^3 \vee S^3$ denote the inclusions of the left and right hand spheres, and put $\alpha_i = [a_i] \in \pi_3(S^3 \vee S^3)$. Attach D_0^8 and D_1^8 to $S^3 \vee S^3$ by the maps $[a_0, [a_0, a_1]_W]_W$ and $[a_1, [a_1, a_0]_W]_W$. The same argument as in Proposition 13.12 shows that the resulting space has a commutative model of the form $(\Lambda V \oplus \mathbb{k}u_0 \oplus \mathbb{k}u_1, D)$ where $u_0u_1 = u_0^2 = u_1^2 = u_0\Lambda^+V = u_1\Lambda^+V = 0$, $Du_0 = Du_1 = 0$, and $Dv = dv + \langle v; [\alpha_0, [\alpha_0, \alpha_1]_W]_W \rangle u_0 + \langle v; [\alpha_1, [\alpha_1, \alpha_0]_W]_W \rangle u_1$. Of course $\deg u_0 = 8 = \deg u_1$.

Now $(\Lambda V, d) = (\Lambda(e_0, e_1, x, y_0, y_1, z_1, z_2, \dots), d)$ with

$$dx = e_0e_1 \quad dy_0 = e_0x, \quad dy_1 = e_1x$$

and $\deg z_i \geq 9, i = 1, 2, \dots$. From Proposition 13.16 it follows that $Dy_0 = e_0x + u_0, Dy_1 = e_1x + u_1$ and $D = d$ on the other basis elements of V .

Moreover, it follows from diagram 13.15 that u_0 and u_1 represent the cohomology classes dual to the cells D_0^8 and D_1^8 , so that $[1], [e_0], [e_1], [u_0]$ and $[u_1]$ is a basis for $H(\Lambda V \oplus \mathbb{k}u_0 \oplus \mathbb{k}u_1, D)$. This implies that a quasi-isomorphism

$$(\Lambda V \oplus \mathbb{k}u_0 \oplus \mathbb{k}u_1, D) \xrightarrow{\cong} (\Lambda(e_0, e_1, x)/e_0e_1x, d)$$

is given by $e_0 \mapsto e_0, e_1 \mapsto e_1, x \mapsto x, y_i \mapsto 0, z_i \mapsto 0, u_0 \mapsto -e_0x$, and $u_1 \mapsto -e_1x$. Thus $(\Lambda(e_0, e_1, x)/e_0e_1x, d)$ is a commutative model for $S^3 \vee S^3 \cup (D_0^8 \amalg D_1^8)$.

We may use this to calculate the minimal Sullivan model of $S^3 \vee S^3 \cup (D_0^8 \amalg D_1^8)$, which has the form

$$(\Lambda(e_0, e_1, x, w, w_0, w_1, \dots), dw = e_0e_1x, dw_0 = e_0w, dw_1 = e_1w, \dots).$$

Note that $\langle w; [\alpha, \beta]_W \rangle = 0$ for all homotopy classes α and β in $\pi_*(S^3 \vee S^3 \cup (D_0^8 \amalg D_1^8))$. □

Exercises

1. Let $f : (X, *) \rightarrow (Y, *)$ be a continuous map between simply connected topological spaces. Determine a Sullivan representative of $\Sigma f : \Sigma X \rightarrow \Sigma Y$.
2. Prove that the cofibre of the natural inclusion $\mathbb{C}P^2 \hookrightarrow \mathbb{C}P^5$ and the space $S^6 \vee S^8 \vee S^{10}$ have the same Sullivan minimal model.
3. Let $(\Lambda V, d)$ be the minimal model of $S^2 \vee S^2$. Determine the elements of $V^{\leq 5}$ which are dual to Whitehead products.
4. Let X be a simply connected H-space. Prove that $[\alpha, \beta]_W = 0$ for every $\alpha, \beta \in \pi_*(X) \otimes \mathbb{Q}$.
5. Let X be a simply connected space and $\alpha \in \pi_n(X), \beta \in \pi_p(X)$.
 - a) Prove that if $E : \pi_q(X) \rightarrow \pi_{q+1}(X)$ denotes the morphism induced by the suspension map $[S^q, X] \rightarrow [S^{q+1}, \Sigma X]$ then $E([\alpha, \beta]_W) = 0$.

b) Prove that if $hur_X : \pi_q(X) \rightarrow H_q(X)$ denotes the Hurewicz homomorphism then $hur([\alpha, \beta]_W) = 0$.

6. Let X be a 1-connected space. Prove that if X is formal then the Hurewicz homomorphism hur_X induces a surjective map $\Lambda(\pi_*(X) \otimes \mathbb{Q})^{\#} \rightarrow H^*(X; \mathbb{Q})$.

7. Consider the quotient algebra $H = \Lambda(x_1, x_2, x_3, x_4) / (x_1x_2, x_1x_3x_4, x_2x_3x_4)$ with $\deg x_1 = \deg x_2 = \deg x_3 = 3$ and $\deg x_4 = 5$. Prove that the Sullivan minimal model $(\Lambda V, d)$ of $(H, 0)$ is given in low degrees by the following table. (The reader is invited to complete the table for $V_j^{\leq 15}$.)

...
	$z_7 \nearrow, z_8 \nearrow$	y_2x_4, y_3x_4		V^{15}
		{ y_2x_1, y_2x_3 y_3x_2, y_3x_3 $x_2y_2 + y_3x_1$ $y_1x_3x_4 + y_3x_1$		V^{14}
	{ $z_3 \nearrow, z_4 \nearrow$ $z_5 \nearrow, z_6 \nearrow$ $z_7 \nearrow$ $z_8 \nearrow$			V^{13}
				V^{12}
	z_1x_1	$y_2 \nearrow, y_3 \nearrow$	$x_1x_3x_4, x_2x_3x_4$	V^{11}
		y_1x_1, y_1x_2		V^{10}
	$z_1 \nearrow, z_2 \nearrow$		x_1x_4 x_2x_4 x_3x_4	V^9
			x_1x_2 x_1x_3 x_2x_3	V^8
		$y_1 \nearrow$	x_4	V^7
			x_1 x_2 x_3	V^6
				V^5
				V^4
				V^3
...	V_2	V_1	V_0	

Assuming that $(\Lambda V, d)$ is the minimal model of a space X , express y_1, z_1 and u in terms of Whitehead products of X . Define $D : V_0 \oplus V_1 \oplus V_2 \rightarrow \Lambda V$ by $Dx_i = 0, Dy_j = dy_j, Dz_k = dz_k, k \neq 1$ and $Dz_1 = y_1x_1 + x_3x_4$. Prove, by induction on the lower degree, that D extends to a differential on ΛV such that $Du = z_1x_1 - y_2$. Determine the minimal model of $(\Lambda V, D)$ in low degrees.

8. Compute the minimal model of the space $X = (S_a^3 \vee S_b^3) \cup_{[a, [a, b]_W]} e^8$ (in low degrees).

14 Relative Sullivan algebras

In this section the ground ring is an arbitrary field \mathbb{k} of characteristic zero.

In §12 we showed how to model commutative cochain algebras (C, d) by Sullivan algebras, $(\Lambda V, d)$. Now any cochain algebra comes equipped with the specific morphism $\mathbb{k} \rightarrow (C, d)$, $1 \mapsto 1$. In this section we introduce relative Sullivan algebras $(B \otimes \Lambda V, d)$ and use them to model general morphisms $(B, d) \rightarrow (C, d)$ of commutative cochain algebras. We shall then prove existence and uniqueness theorems in this setting. This will, in particular, eliminate the hypothesis $H^1 = 0$ that was frequently supposed in §12.

Definition A *relative Sullivan algebra* is a commutative cochain algebra of the form $(B \otimes \Lambda V, d)$ where

- $(B, d) = (B \otimes 1, d)$ is a sub cochain algebra, and $H^0(B) = \mathbb{k}$.
- $1 \otimes V = V = \{V^p\}_{p \geq 1}$.
- $V = \bigcup_{k=0}^{\infty} V(k)$, where $V(0) \subset V(1) \subset \dots$ is an increasing sequence of graded subspaces such that

$$d : V(0) \rightarrow B \quad \text{and} \quad d : V(k) \rightarrow B \otimes \Lambda V(k-1), \quad k \geq 1.$$

The third condition is called the *nilpotence condition on d* . It can be restated as follows: if we put $V(-1) = 0$ and write $V(k) = V(k-1) \otimes V_k$ for some graded subspace V_k then

$$B \otimes \Lambda V(k) = [B \otimes \Lambda V(k-1)] \otimes \Lambda V_k, \quad \text{and} \quad d : V_k \rightarrow B \otimes \Lambda V(k-1), \quad k \geq 0.$$

Note that we identify $B = B \otimes 1$ and $\Lambda V = 1 \otimes \Lambda V$. We shall follow this convention throughout the rest of this monograph. However, while (B, d) is a sub cochain algebra it will almost always be the case that the *differential does not preserve ΛV* . The sub cochain algebra (B, d) is called the *base algebra* of $(B \otimes \Lambda V, d)$.

A Sullivan algebra is just a relative Sullivan algebra with $B = \mathbb{k}$. On the other hand if $\varepsilon : (B, d) \rightarrow \mathbb{k}$ is any augmentation then applying $\mathbb{k} \otimes_B -$ to $(B \otimes \Lambda V, d)$ yields a Sullivan algebra $(\Lambda V, \bar{d})$, the *Sullivan fibre at ε* .

Now, generalizing the Sullivan models of §12, we consider morphisms of commutative cochain algebras

$$\varphi : (B, d) \rightarrow (C, d)$$

such that $H^0(B) = \mathbb{k}$ and make the

Definition A *Sullivan model* for φ is a quasi-isomorphism of cochain algebras

$$m : (B \otimes \Lambda V, d) \xrightarrow{\cong} (C, d)$$

such that $(B \otimes \Lambda V, d)$ is a relative Sullivan algebra with base (B, d) and $m|_B = \varphi$.

If $f : X \rightarrow Y$ is a continuous map then a Sullivan model for $A_{PL}(f)$ is called a *Sullivan model* for f .

In the case of the morphism $\mathbb{k} \rightarrow (A, d)$ this definition reduces to the definition of a Sullivan model of (A, d) . As in that case, we shall frequently abuse language and refer simply to $(B \otimes \Lambda V, d)$ as the Sullivan model of φ .

Also as in the case of Sullivan algebras, the minimal relative Sullivan algebras play a distinguished role:

Definition A relative Sullivan algebra $(B \otimes \Lambda V, d)$ is *minimal* if

$$\text{Im } d \subset B^+ \otimes \Lambda V + B \otimes \Lambda^{\geq 2} V.$$

A *minimal Sullivan model* for $\varphi : (B, d) \rightarrow (C, d)$ is a Sullivan model $(B \otimes \Lambda V, d) \xrightarrow{\cong} (C, d)$ such that $(B \otimes \Lambda V, d)$ is minimal.

Suppose $\varphi : (B, d) \rightarrow (C, d)$ has a Sullivan model $m : (B \otimes \Lambda V, d) \xrightarrow{\cong} (C, d)$. By definition, $H^0(B) = \mathbb{k}$ and the isomorphism $H(m)$ identifies $H(\lambda)$ with $H(\varphi)$, where λ is the inclusion of B in $B \otimes \Lambda V$. Since V is concentrated in degrees ≥ 1 , it follows that $H^0(C) = \mathbb{k}$ and $H^1(\varphi)$ is injective.

Conversely, if $H^0(B) = H^0(C) = \mathbb{k}$ and if $H^1(\varphi)$ is injective we shall show that φ has a minimal Sullivan model, determined uniquely up to isomorphism. This depends on another result we shall also establish: any relative Sullivan algebra is the tensor product of a contractible Sullivan algebra and a minimal relative Sullivan algebra with the same base.

The importance of relative Sullivan algebras resides in the fact that they provide good models for fibrations. Indeed, suppose $p : X \rightarrow Y$ is a fibration with fibre F and suppose $(A_{PL}(Y) \otimes \Lambda V, d)$ is a relative Sullivan model for $A_{PL}(p) : A_{PL}(Y) \rightarrow A_{PL}(X)$. In §15 we shall show that if Y is simply connected and if one of $H_*(F; \mathbb{k})$, $H_*(Y; \mathbb{k})$ has finite type then $(\Lambda V, \bar{d}) = \mathbb{k} \otimes_{A_{PL}(Y)} (A_{PL}(Y) \otimes \Lambda V, d)$ is a Sullivan model for F . It is from this that we deduce that the morphism defined in §13(c) is an isomorphism:

$$V \xrightarrow{\cong} \text{Hom}_{\mathbb{Z}}(\pi_*(X), \mathbb{k}) ,$$

for minimal Sullivan models $(\Lambda V, d)$ of suitable topological spaces X .

This section is organized into the following topics:

- (a) The semifree property, existence of models and homotopy.
- (b) Minimal Sullivan models.

(a) The semifree property, existence of models and homotopy.

Let $(B \otimes \Lambda V, d)$ be a relative Sullivan algebra. Multiplication by B makes $(B \otimes \Lambda V, d)$ into a left (B, d) -module (cf. §6) and we shall make frequent use of

Lemma 14.1 $(B \otimes \Lambda V, d)$ is (B, d) -semifree.

proof: Write $V = \bigcup_{k \geq 0} V(k)$ as in the definition, and set $V(-1) = 0$. Write $V(k) = V(k-1) \oplus V_k$, and simplify notation by writing $B \otimes \Lambda V(k) = B(k)$. Then $B(k) = B(k-1) \otimes \Lambda V_k$ and $d : V_k \rightarrow B(k-1)$. Hence

$$\frac{(B(k-1) \otimes \Lambda^{\leq n} V_k, d)}{(B(k-1) \otimes \Lambda^{< n} V_k, d)} = (B(k-1), d) \otimes (\Lambda^n V_k, 0).$$

Assume by induction that $(B(k-1), d)$ is (B, d) -semifree. Then this equation identifies the quotient on the left as (B, d) -semifree for each $n \geq 1$. It follows from Lemma 6.3 that each $(B(k), d)$ and $(B(k), d) / (B(k-1), d)$ are (B, d) -semifree. Now a second application of Lemma 6.3 shows that $(B \otimes \Lambda V, d) = \bigcup_k (B(k), d)$ is (B, d) -semifree too. \square

A second useful fact is the ‘preservation under pushout’ of relative Sullivan algebras. Suppose $(B \otimes \Lambda V, d)$ is a relative Sullivan algebra and $\psi : (B, d) \rightarrow (B', d)$ is a morphism of commutative cochain algebras with $H^0(B') = \mathbb{k}$. Then, immediately from the definition, the cochain algebra

$$(B', d) \otimes_{(B, d)} (B \otimes \Lambda V, d) = (B' \otimes \Lambda V, d)$$

is a relative Sullivan algebra with base algebra (B', d) . It is called the *pushout of $(B \otimes \Lambda V, d)$ along ψ* .

Notice that associated with the pushout is the commutative diagram of cochain algebra morphisms

$$\begin{array}{ccc} (B, d) & \longrightarrow & (B \otimes \Lambda V, d) \\ \psi \downarrow & & \downarrow \psi \otimes id \\ (B', d) & \longrightarrow & (B' \otimes \Lambda V, d). \end{array}$$

To see that $\psi \otimes id$ commutes with the differentials, identify $B \otimes \Lambda V = B \otimes_B (B \otimes \Lambda V)$ and observe that

$$\psi \otimes id_{\Lambda V} = \psi \otimes_B (id_{B \otimes \Lambda V}) : B \otimes_B (B \otimes \Lambda V) \rightarrow B' \otimes_B (B \otimes \Lambda V).$$

Now Proposition 6.7(iii) asserts that $- \otimes_B (B \otimes \Lambda V, d)$ preserves quasi-isomorphisms because $(B \otimes \Lambda V, d)$ is (B, d) -semifree. There follows

Lemma 14.2 If ψ is a quasi-isomorphism so is $\psi \otimes id : (B \otimes \Lambda V, d) \rightarrow (B' \otimes \Lambda V, d)$. \square

We can now establish the existence of Sullivan models for morphisms:

Proposition 14.3 A morphism $\varphi : (B, d) \rightarrow (C, d)$ of commutative cochain algebras has a Sullivan model if $H^0(B) = \mathbb{k} = H^0(C)$ and $H^1(\varphi)$ is injective.

proof: Choose a graded subspace $B_1 \subset B$ so that

$$(B_1)^0 = \mathbb{k}, (B_1)^1 \oplus d(B^0) = B^1 \quad \text{and} \quad (B_1)^n = B^n, \quad n \geq 2.$$

Clearly (B_1, d) is a sub cochain algebra and the inclusion $\varphi : (B_1, d) \rightarrow (B, d)$ is a quasi-isomorphism. In particular the restriction $\varphi_1 : (B_1, d) \rightarrow (C, d)$ of φ satisfies: $H^1(\varphi_1)$ is injective.

Now because $(B_1)^0 = \mathbb{k}$ the argument of Proposition 12.1 applies verbatim to show the existence of a Sullivan model $m_1 : (B_1 \otimes \Lambda V, d) \xrightarrow{\cong} (C, d)$ for φ_1 . Thus a commutative diagram of cochain algebra morphisms is given by

$$\begin{array}{ccc} (B, d) \otimes_{(B_1, d)} (B_1 \otimes \Lambda V, d) & \xrightarrow{m} & (C, d) \\ & \swarrow j & \nearrow m_1 \\ & (B_1 \otimes \Lambda V, d) & \end{array}$$

in which $j(z) = 1 \otimes_{B_1} z$.

This may be rewritten as

$$\begin{array}{ccc} (B \otimes \Lambda V, d) & \xrightarrow{m} & (C, d) \\ & \swarrow i \otimes id & \nearrow \cong \\ & (B_1 \otimes \Lambda V, d) & \end{array}$$

Lemma 14.2 and the preceding remarks show that $i \otimes id$ is a quasi-isomorphism and $(B \otimes \Lambda V, d)$ is a Sullivan algebra; hence $m : (B \otimes \Lambda V, d) \xrightarrow{\cong} (C, d)$ is a Sullivan model for φ . □

Finally, we extend the lifting lemma to the relative case and define relative homotopy. To begin, suppose given a commutative diagram of morphisms of commutative cochain algebras

$$\begin{array}{ccc} (B, d) & \xrightarrow{\alpha} & (A, d) \\ \downarrow i & & \downarrow \cong \eta \\ (B \otimes \Lambda V, d) & \xrightarrow{\psi} & (C, d) \end{array}$$

in which i is the base inclusion of a relative Sullivan algebra and η is a surjective quasi-isomorphism. An argument identical to that of Lemma 12.4 establishes

Lemma 14.4 *There is a morphism $\varphi : (B \otimes \Lambda V, d) \rightarrow (A, d)$ such that $\varphi i = \alpha$ (φ extends α) and $\eta \varphi = \psi$ (φ lifts ψ). □*

We come now to the notation of *relative homotopy*. Suppose

$$\varphi_0, \varphi_1 : (B \otimes \Lambda V, d) \longrightarrow (A, d)$$

are two morphisms of commutative cochain algebras, in which $(B \otimes \Lambda V, d)$ is a relative Sullivan algebra and φ_0 and φ_1 restrict to the same morphism $\alpha : (B, d) \longrightarrow (A, d)$. Generalizing the definition in §12(b) we have

Definition φ_0 and φ_1 are *homotopic rel B* ($\varphi_0 \sim \varphi_1 \text{ rel } B$) if there is a morphism

$$\Phi : (B \otimes \Lambda V, d) \longrightarrow (A, d) \otimes \Lambda(t, dt)$$

such that $(id \cdot \varepsilon_0)\Phi = \varphi_0$, $(id \cdot \varepsilon_1)\Phi = \varphi_1$ and $\Phi(b) = \alpha(b) \otimes 1$, $b \in B$. The morphism Φ is called a *relative homotopy from φ_0 to φ_1* .

The identical argument of Proposition 12.7 shows that homotopy rel B is an equivalence relation in the set of morphisms $\varphi : (B \otimes \Lambda V, d) \longrightarrow (A, d)$ that restrict to a given $\alpha : (B, d) \longrightarrow (A, d)$. The homotopy class of φ is denoted by $[\varphi]$ and the set of homotopy classes is denoted by $[(B \otimes \Lambda V, d), (A, d)]_\alpha$.

Notice that $\alpha : (B, d) \longrightarrow (A, d)$ makes (A, d) into a (B, d) -module via $b \cdot a = \alpha(b)a$. Now suppose $\varphi_0, \varphi_1 : (B \otimes \Lambda V, d) \longrightarrow (A, d)$ both restrict to α .

Lemma 14.5 *If $\varphi_0 \sim \varphi_1 \text{ rel } B$ then $\varphi_0 - \varphi_1 = hd + dh$, where $h : B \otimes \Lambda V \longrightarrow A$ is a B -linear map of degree -1 . In particular, $H(\varphi_0) = H(\varphi_1)$.*

proof: Let $\Phi : (B \otimes \Lambda V, d) \longrightarrow (A, d) \otimes \Lambda(t, dt)$ be a homotopy rel B from φ_0 to φ_1 . As in the proof of Proposition 12.8, define $h : B \otimes \Lambda V \longrightarrow A$ by

$$\Phi(z) = \varphi_0(z) + (\varphi_1(z) - \varphi_0(z))t + (-1)^{\deg z} h(z)dt + \Omega,$$

where $\Omega \in A \otimes (I + dI)$, $I \subset \Lambda(t)$ denoting the ideal generated by $t(1-t)$. Then, because $d\Phi = \Phi d$, we obtain $\varphi_0 - \varphi_1 = dh + hd$. Moreover, since Φ restricts to α in B it follows that $\Phi(bz) = \alpha(b)\Phi(z)$, $b \in B$. Hence $h(bz) = (-1)^{\deg b} b \cdot h(z)$; i.e., h is B -linear. □

Finally, suppose that

$$\begin{array}{ccc} (B, d) & \xrightarrow{\alpha} & (A, d) \\ \downarrow i & & \downarrow \simeq \eta \\ (B \otimes \Lambda V, d) & \xrightarrow{\psi} & (C, d) \end{array}$$

is a commutative square of morphisms of commutative cochain algebra, in which

- i is the base inclusion of a relative Sullivan algebra, and
- η is a quasi-isomorphism.

Note that we do *not* require that η be surjective.

The proof of Proposition 12.9 also goes over verbatim to give

Proposition 14.6 (*Lifting lemma*) *There is a unique homotopy class rel B of morphisms $\varphi : (B \otimes \Lambda V, d) \rightarrow (A, d)$ such that*

$$\varphi|_B = \alpha \quad \text{and} \quad \eta\varphi \sim \psi \text{ rel } B.$$

□

(b) Minimal Sullivan models.

Here we establish three basic results.

- *Any relative Sullivan algebra is the tensor product of a minimal relative Sullivan algebra and a contractible algebra (Theorem 14.9).*
- *A quasi-isomorphism between minimal relative Sullivan algebras is an isomorphism, provided it restricts to an isomorphism of the base algebras (Theorem 14.11).*
- *Minimal Sullivan models of cochain algebras and of morphisms exist, and are unique up to isomorphism (Theorem 14.12).*

For ordinary Sullivan algebras these results extend Proposition 12.2 and several results in §12(c) to the case where $H^1(-)$ is not necessarily zero.

Before beginning the proofs, we make two small but useful observations. Consider first an arbitrary commutative graded algebra of the form $B = \mathbb{k} \oplus \{B^i\}_{i \geq 1}$, and a graded vector space $V = \{V^i\}_{i \geq 1}$. Let $W \subset (B \otimes \Lambda V)^+$ be a graded subspace such that

$$(B \otimes \Lambda V)^+ = W \oplus \Lambda^{\geq 2} V \oplus (B^+ \otimes \Lambda V).$$

The inclusions of B and W extend uniquely to a morphism $\sigma : B \otimes \Lambda W \rightarrow B \otimes \Lambda V$ of graded algebras.

Lemma 14.7 *The morphism $\sigma : B \otimes \Lambda W \rightarrow B \otimes \Lambda V$ is an isomorphism.*

proof: It follows from the hypothesis that $V^n \subset W^n + B \otimes \Lambda V^{<n}$, $n \geq 1$, and an obvious induction then gives that σ is surjective. Choose $\alpha : V \rightarrow B \otimes \Lambda W$ so that $\sigma\alpha = id$, and extend id_B and α to the morphism $\tau = id_B \cdot \alpha : B \otimes \Lambda V \rightarrow B \otimes \Lambda W$. Then $\sigma\tau = id$.

Now suppose by induction that σ and τ restrict to inverse isomorphisms between $B \otimes \Lambda W^{<n}$ and $B \otimes \Lambda V^{<n}$. Let $w \in W^n$. Then $\tau w = w' + u$ with $w' \in W^n$ and $u \in B^+ \otimes \Lambda W^{<n}$. Hence $w = \sigma\tau w = \sigma w' + \sigma u = w' + \sigma u$. In other words,

$$w - w' = \sigma u \in W \cap (B^+ \otimes \Lambda V^{<n}) = 0.$$

By induction, σ is injective in $B \otimes \Lambda V^{<n}$. Hence $w = w'$ and $u = 0$; i.e., $\tau w = w$. This shows that $\tau\sigma = id$ in W^n ; which closes the induction. \square

Next, suppose $(B \otimes \Lambda V, d)$ is any relative Sullivan algebra. Choose a graded vector space $B_1 \subset B$ so that $(B_1)^0 = \mathbb{k}$, $(B_1)^1 \oplus d(B^0) = B^1$ and $(B_1)^i = B^i$, $i \geq 2$. Then B_1 is preserved by d , (B_1, d) is a sub cochain algebra and the inclusion in (B, d) is a quasi-isomorphism.

Lemma 14.8 *There is a relative Sullivan algebra $(B_1 \otimes \Lambda V, d')$ and an isomorphism,*

$$\sigma : (B \otimes \Lambda V, d) = (B, d) \otimes_{(B_1, d)} (B_1 \otimes \Lambda V, d') \xrightarrow{\cong} (B \otimes \Lambda V, d),$$

restricting to the identity in B .

proof: Write $V = \bigcup_{k \geq 0} V(k)$ with

$$(B \otimes \Lambda V(k), d) = (B \otimes \Lambda V(k-1) \otimes \Lambda V_k, d)$$

and $d : V_k \rightarrow B \otimes \Lambda V(k-1)$. Assume by induction we have constructed $(B_1 \otimes \Lambda V(k-1), d')$ and

$$\sigma : (B \otimes \Lambda V(k-1), d') \xrightarrow{\cong} (B \otimes \Lambda V(k-1), d).$$

Lemma 14.2, applied to the inclusion $(B_1, d) \rightarrow (B, d)$ shows that the inclusion $(B_1 \otimes \Lambda V(k-1), d') \rightarrow (B \otimes \Lambda V(k-1), d')$ is a quasi-isomorphism. Hence if $\{v_\alpha\}$ is a basis of V_k there are d' -cocycles $z_\alpha \in B_1 \otimes \Lambda V(k-1)$ and elements $y_\alpha \in B \otimes \Lambda V(k-1)$ such that $dv_\alpha = \sigma(z_\alpha + d'y_\alpha)$. Extend d' and σ to V_k by setting $d'v_\alpha = z_\alpha$ and $\sigma v_\alpha = v_\alpha - \sigma y_\alpha$.

By construction, σ is a cochain algebra morphism. By induction, it restricts to an isomorphism of $B \otimes \Lambda V(k-1)$ onto itself. Denote the inverse of the restriction by τ , extend τ to $B \otimes \Lambda V(k)$ by setting $\tau v_\alpha = v_\alpha + y_\alpha$, and verify that τ and σ are inverse isomorphisms of $B \otimes \Lambda V(k)$. \square

Theorem 14.9 *Let $(B \otimes \Lambda V, d)$ be a relative Sullivan algebra. Then the identity of B extends to an isomorphism of cochain algebras,*

$$(B \otimes \Lambda W, d') \otimes (\Lambda(U \oplus dU), d) \xrightarrow{\cong} (B \otimes \Lambda V, d),$$

in which $(B \otimes \Lambda W, d')$ is a minimal relative Sullivan algebra and $(\Lambda(U \oplus dU), d)$ is contractible.

proof: First consider the case $B = \mathbb{k} \oplus \{B^i\}_{i \geq 1}$. The decomposition

$$(B \otimes \Lambda V)^+ = (B^+ \otimes \Lambda V) \oplus \Lambda^{\geq 2} V \oplus V$$

defines a differential $d_0 : V \rightarrow V$ by the condition $dv - d_0v \in (B^+ \otimes \Lambda V) \oplus \Lambda^{\geq 2}V$, $v \in V$. Write V as the increasing union of graded subspaces $V(k)$ such that $d : V(k) \rightarrow B \otimes \Lambda V(k-1)$ and note that

$$d - d_0 : V(k)^n \rightarrow B \otimes \Lambda(V(k-1)^{\leq n}).$$

Choose an increasing sequence $U(0) \subset U(1) \subset \dots \subset V$ of graded subspaces such that

$$U(k) \oplus (\ker d_0 \cap V(k)) = V(k).$$

(Since $U(k-1) \cap (\ker d_0 \cap V(k)) = 0$, $U(k-1)$ can be enlarged to the direct summand $U(k)$.) Set $U = \bigcup_k U(k)$. Then $U \oplus \ker d_0 = V$ and so we may write

$$V = U \oplus d_0U \oplus W, \quad d_0 : U \xrightarrow{\cong} d_0U, \quad d_0 : W \rightarrow 0.$$

This construction has the following useful property: for elements $u, u_1 \in U$ and $w \in W$,

$$u_1 + d_0u + w \in V(k) \implies u_1 \in V(k). \tag{14.10}$$

Indeed, we may write $u_1 + d_0u + w = u' + z'$ with $u' \in U(k)$ and $z' \in \ker d_0$. Thus $u_1 - u' = z' - d_0u - w \in U \cap \ker d_0 = 0$, and $u_1 = u'$.

Now consider the subspace $U \oplus dU \oplus W \subset B \otimes \Lambda V$. Apply Lemma 14.7 to conclude that this inclusion, together with id_B , extends to an isomorphism of graded algebras,

$$\sigma : B \otimes \Lambda U \otimes \Lambda dU \otimes \Lambda W \xrightarrow{\cong} B \otimes \Lambda V.$$

Denote the contractible algebra $\Lambda U \otimes \Lambda dU$ simply by E , and let $d = \sigma^{-1}d\sigma$ be the induced differential in $B \otimes E \otimes \Lambda W$. Use σ to identify the two cochain algebras and so regard V as a subspace of $B \otimes E \otimes \Lambda W$.

Our next step is to exhibit the inclusion

$$(B, d) \otimes (E, d) \rightarrow (B \otimes E \otimes \Lambda W, d)$$

as the inclusion of a relative Sullivan algebra. Define an increasing sequence of graded subspaces $W(0) \subset W(1) \subset \dots \subset W$ by $W(0) = \{w \in W \mid dw \in B \otimes E\}$ and $W(\ell) = \{w \in W \mid dw \in B \otimes E \otimes \Lambda W(\ell-1)\}$, $\ell \geq 1$. Set $Z = \bigcup_\ell W(\ell)$. It is enough to show $Z = W$.

Assume $V^{<n} \subset B \otimes E \otimes \Lambda Z$. We show first by induction on k that

$$V(k)^n \subset B \otimes E \otimes \Lambda Z.$$

Indeed if $v \in V(0)^n$ we have $dv \in B$, so that $d_0v = 0$ and $v = d_0u + w$, some $u \in U^{n-1}$, $w \in W^n$. As observed above, $(d_0 - d)u \in B \otimes \Lambda V^{<n}$, and hence $(d_0 - d)u \in B \otimes E \otimes \Lambda Z$. It follows that

$$d(d_0u) = d(d_0 - d)u \in B \otimes E \otimes \Lambda Z.$$

But $dv \in B$ and so $dw = dv - dd_0u \in B \otimes E \otimes \Lambda Z$. In particular, we must have $dw \in B \otimes E \otimes \Lambda W(\ell)$, some ℓ , and so $w \in W(\ell + 1)$. On the other hand, we have just seen that $(d_0 - d)u \in B \otimes E \otimes \Lambda Z$. Since $du \in E$ by definition, it follows that $d_0u \in B \otimes E \otimes \Lambda Z$. Thus $v = d_0u + w \in B \otimes E \otimes \Lambda Z$; i.e., $V(0)^n \subset B \otimes E \otimes \Lambda Z$.

Suppose $V(k - 1)^n \subset B \otimes E \otimes \Lambda Z$. Let $v \in V(k)^n$ and write $v = u_1 + d_0u + w$, with $u_1 \in U^n$, $u \in U^{n-1}$ and $w \in W^n$. As observed in (14.10), then $u_1 \in V(k)$. Hence $(d - d_0)u_1 \in B \otimes \Lambda V(k - 1)^{\leq n} \subset B \otimes E \otimes \Lambda Z$. The same argument as just above for $k = 0$ shows that $(d - d_0)d_0u = d(d_0 - d)u \in B \otimes E \otimes \Lambda Z$. Hence

$$dw = (d - d_0)w \in B \otimes E \otimes \Lambda Z$$

and so, as in the case $k = 0$, it follows that $w \in Z$. As in that case, $d_0u \in B \otimes E \otimes \Lambda Z$, while $u_1 \in E$ by definition. This shows that $V(k)^n \subset B \otimes E \otimes \Lambda Z$.

It follows by induction on k that $V^n \subset B \otimes E \otimes \Lambda Z$, and so a second induction on n shows that $V \subset B \otimes E \otimes \Lambda Z$. This implies that $B \otimes E \otimes \Lambda Z$ is all of $B \otimes E \otimes \Lambda W$, and so $Z = W$, as desired.

Finally, let $\varepsilon : E \rightarrow \mathbb{k}$ be the augmentation. Then $id \cdot \varepsilon : (B, d) \otimes (E, d) \rightarrow (B, d)$ is a quasi-isomorphism. Hence it defines a surjective quasi-isomorphism

$$id \cdot \varepsilon \otimes id : (B \otimes E \otimes \Lambda W, d) \rightarrow (B \otimes \Lambda W, d'),$$

as described in Lemma 14.2.

In particular, $(B \otimes \Lambda W, d')$ is a relative Sullivan algebra and, since $d : W \rightarrow B^+ \otimes E \otimes \Lambda W + (B \otimes E \otimes \Lambda W)^+ \cdot (B \otimes E \otimes \Lambda W)^+$, it follows that $d' : W \rightarrow B^+ \otimes \Lambda W \oplus \Lambda^{\geq 2}W$; i.e., $(B \otimes \Lambda W, d')$ is minimal. Apply the Lifting lemma 14.4 to extend id_B to a morphism

$$\varphi : (B \otimes \Lambda W, d') \rightarrow (B \otimes E \otimes \Lambda W, d)$$

such that $(id \cdot \varepsilon \otimes id)\varphi = id$.

Then $\varphi w - w \in B \otimes E^+ \otimes \Lambda W$. This implies (Lemma 14.7) that an isomorphism

$$(B \otimes \Lambda W, d') \otimes (\Lambda(U \oplus dU)) \xrightarrow{\cong} (B \otimes \Lambda V, d)$$

is given by $\Phi \otimes \Psi \mapsto \sigma(\varphi\Phi \cdot \Psi)$. This completes the proof of the theorem in the case $B^0 = \mathbb{k}$.

Finally, suppose $(B \otimes \Lambda V, d)$ is a general relative Sullivan algebra. Write $(B \otimes \Lambda V, d) = (B, d) \otimes_{(B_1, d)} (B_1 \otimes \Lambda V, d)$, as in Lemma 14.8, with $(B_1)^0 = \mathbb{k}$. By what we have just proved, $(B_1 \otimes \Lambda V, d) \cong (B_1 \otimes \Lambda W, d') \otimes \Lambda(U \oplus dU)$. Thus $(B \otimes \Lambda V, d) \cong (B \otimes \Lambda W, d') \otimes \Lambda(U \oplus dU)$. \square

Next, consider a cochain algebra quasi-isomorphism

$$\eta : (B' \otimes \Lambda V', d) \xrightarrow{\cong} (B \otimes \Lambda V, d)$$

between minimal relative Sullivan algebras.

Theorem 14.11 *If η restricts to an isomorphism $\eta_B : B' \xrightarrow{\cong} B$ then η itself is an isomorphism.*

proof: Consider the diagram

$$\begin{array}{ccc}
 & (B' \otimes \Lambda V', d) & \\
 \nearrow \eta_B^{-1} & \downarrow \simeq \eta & \\
 (B, d) & \longrightarrow & (B \otimes \Lambda V, d)
 \end{array}$$

We apply an argument of Gomez-Tato [65] to extend η_B^{-1} to a morphism $\gamma : (B \otimes \Lambda V, d) \rightarrow (B' \otimes \Lambda V', d)$ such that $\eta\gamma = id$.

By the very definition of minimality, $d : V \rightarrow B^+ \otimes \Lambda V \oplus \Lambda^{\geq 2} V$. Thus if $V = \bigcup_k V(k)$ with $V(k) = V(k-1) \oplus V_k$ and $d : V_k \rightarrow B \otimes \Lambda V(k-1)$ it follows that $d : V_k^n \rightarrow B \otimes \Lambda V^{<n} \otimes \Lambda(V(k-1)^n)$. Thus to construct γ it is enough to assume it has been defined in $A = B \otimes \Lambda V^{<n} \otimes \Lambda(V(k-1)^n)$ and to extend it to $A \otimes \Lambda V_k^n$.

Observe that η factors to give a quasi-isomorphism of cochain complexes,

$$\frac{B' \otimes \Lambda V'}{\gamma(A)} \xrightarrow[\simeq]{\bar{\eta}} \frac{B \otimes \Lambda V}{A},$$

(we are dividing by graded subspaces, not ideals). The cochain complex $B \otimes \Lambda V/A$ contains no elements of degree $n-1$, and hence no coboundaries of degree n . Thus every cocycle of degree n is the image, under $\bar{\eta}$, of a cocycle of degree n in $(B' \otimes \Lambda V')/\gamma(A)$. In particular, if $\{v_\alpha\}$ is a basis of V_k^n then there are elements $x_\alpha \in B' \otimes \Lambda V'$ and elements $a_\alpha, a'_\alpha \in A$ such that

$$\eta x_\alpha = v_\alpha + a_\alpha \quad \text{and} \quad dx_\alpha = \gamma(a'_\alpha).$$

Hence $dv_\alpha = d\eta(x_\alpha - \gamma a_\alpha) = a'_\alpha - da_\alpha$. Extend γ to V_k^n by putting $\gamma v_\alpha = x_\alpha - \gamma a_\alpha$.

This completes the construction of γ . Since $\eta\gamma = id$, γ is also a quasi-isomorphism. Now the same argument applied to γ gives a morphism $\chi : (B' \otimes \Lambda V', d) \rightarrow (B \otimes \Lambda V, d)$ such that $\gamma\chi = id$. Thus γ is both injective and surjective; i.e., it is an isomorphism. Since $\eta\gamma = id$, η is the isomorphism γ^{-1} . □

Finally, suppose

$$\varphi : (B, d) \rightarrow (C, d)$$

is a morphism of commutative cochain algebras such that $H^0(B) = \mathbb{k} = H^0(C)$ and $H^1(\varphi)$ is injective.

Theorem 14.12 *The morphism φ has a minimal Sullivan model*

$$m : (B \otimes \Lambda V, d) \xrightarrow{\cong} (C, d).$$

If $m' : (B \otimes \Lambda V', d) \xrightarrow{\cong} (C, d)$ is a second minimal Sullivan model for φ then there is an isomorphism

$$\alpha : (B \otimes \Lambda V, d) \xrightarrow{\cong} (B \otimes \Lambda V', d)$$

restricting to id_B , and such that $m'\alpha \sim m \text{ rel } B$.

proof: In Proposition 14.3 we showed φ had a Sullivan model, and in Theorem 14.9 we showed that this is the tensor product of a contractible algebra and a minimal relative Sullivan algebra. Thus φ has a minimal Sullivan model.

Given two such models we may apply Proposition 14.6 to the diagram

$$\begin{array}{ccc} (B, d) & \longrightarrow & (B \otimes \Lambda V', d) \\ \downarrow & & \cong \downarrow m' \\ (B \otimes \Lambda V, d) & \xrightarrow{\cong m} & (C, d) \end{array}$$

to extend id_B to a morphism $\alpha : (B \otimes \Lambda V, d) \rightarrow (B \otimes \Lambda V', d)$ such that $m'\alpha \sim m \text{ rel } B$. Now Theorem 14.11 asserts that α is an isomorphism. \square

Corollary *Any commutative cochain algebra (A, d) satisfying $H^0(A) = \mathbb{k}$ and any path connected topological space X have a unique minimal Sullivan model.*

Finally, let $\varphi : (\Lambda V, d) \rightarrow (\Lambda W, d)$ be an arbitrary morphism between Sullivan algebras. Recall that $d_0 : V \rightarrow V$ and $d_0 : W \rightarrow W$ denote the linear parts of the differentials (§12(a)) and that the linear part of φ is a morphism of complexes $Q(\varphi) : (V, d_0) \rightarrow (W, d_0)$.

Proposition 14.13 *If $\varphi : (\Lambda V, d) \rightarrow (\Lambda W, d)$ is a morphism of Sullivan algebras then φ is a quasi-isomorphism if and only if $H(Q(\varphi))$ is an isomorphism.*

proof: Write $(\Lambda V, d) = (\Lambda \bar{V}, d) \otimes (E, d)$ and $(\Lambda W, d) = (\Lambda \bar{W}, d) \otimes (F, d)$ with $(\Lambda \bar{V}, d)$ and $(\Lambda \bar{W}, d)$ minimal Sullivan algebras and (E, d) and (F, d) contractible Sullivan algebras. Let ψ be the composite $(\Lambda \bar{V}, d) \rightarrow (\Lambda V, d) \xrightarrow{\varphi} (\Lambda W, d) \rightarrow (\Lambda \bar{W}, d)$. Then we may identify $H(\varphi) = H(\psi)$ and $H(Q(\varphi)) = Q(\psi)$. But by Theorem 14.11, ψ is a quasi-isomorphism if and only if it is an isomorphism. If ψ is an isomorphism so is $Q(\psi)$. Conversely, suppose $Q(\psi)$ is an isomorphism, then ψ induces isomorphisms $\Lambda^{\geq m} \bar{V} / \Lambda^{> m} \bar{V} \xrightarrow{\cong} \Lambda^{\geq m} \bar{W} / \Lambda^{> m} \bar{W}$. By induction it induces isomorphisms $\Lambda \bar{V} / \Lambda^{> m} \bar{V} \xrightarrow{\cong} \Lambda \bar{W} / \Lambda^{> m} \bar{W}$. Since $(\Lambda \bar{V})^k = (\Lambda \bar{V} / \Lambda^{> m} \bar{V})^k$ for $m > k$ it follows that ψ is an isomorphism. \square

Example 1 *The acyclic closure, $(B \otimes \Lambda V, d)$.*

Suppose (B, d) is an augmented commutative cochain algebra such that $H^0(B) = \mathbb{k}$ and $H^1(B) = 0$. A minimal Sullivan model $(B \otimes \Lambda V, d) \xrightarrow{\cong} \mathbb{k}$ for the augmentation $\varepsilon : (B, d) \rightarrow \mathbb{k}$ is called an *acyclic closure* for (B, d) . We show that *the quotient differential \bar{d} in ΛV is zero.*

Form the relative Sullivan algebra $(B \otimes \Lambda V \otimes_B B \otimes \Lambda V, d) = (B \otimes \Lambda V \otimes \Lambda V, d)$. The inclusions of the left and right tensorands are the base inclusions $\lambda_0, \lambda_1 : (B \otimes \Lambda V, d) \rightarrow (B \otimes \Lambda V \otimes \Lambda V, d)$ of relative Sullivan algebras. Hence $\varepsilon \otimes_{\lambda_0} -$ and $\varepsilon \otimes_{\lambda_1} -$ are surjective quasi-isomorphisms from $(B \otimes \Lambda V \otimes \Lambda V, d)$ to $(\Lambda V, d)$.

Let $\alpha : (\Lambda V, \bar{d}) \xrightarrow{\cong} (B \otimes \Lambda V \otimes \Lambda V, d)$ be a quasi-isomorphism such that $(\varepsilon \otimes_{\lambda_1} -) \circ \alpha = id$ (Lemma 12.4). Then $(\varepsilon \otimes_{\lambda_0} -) \circ \alpha$ is a quasi-isomorphism of the minimal Sullivan algebra $(\Lambda V, \bar{d})$. Hence (Theorem 14.11) it is an isomorphism. Denote by β the inverse isomorphism, and consider the composite morphism

$$\mu : (\Lambda V, \bar{d}) \xrightarrow{\alpha} (B \otimes \Lambda V \otimes \Lambda V, d) \xrightarrow{\varepsilon \otimes id \otimes id} (\Lambda V, \bar{d}) \otimes (\Lambda V, \bar{d}) \xrightarrow{\beta \otimes id} (\Lambda V, \bar{d}) \otimes (\Lambda V, \bar{d}).$$

By construction, for $z \in \Lambda^+ V$ we have

$$\mu z = z \otimes 1 + a + 1 \otimes z, \quad \text{some } a \in \Lambda^+ V \otimes \Lambda^+ V.$$

Hence for any cocycle z ,

$$H(\mu)[z] - [z] \otimes 1 - 1 \otimes [z] \in H^+(\Lambda V) \otimes H^+(\Lambda V).$$

In Example 3, §12(a), we showed that a certain algebra $H^*(X; \mathbb{k})$ was a free graded commutative algebra using by the existence of a morphism $H^*(X; \mathbb{k}) \rightarrow H^*(X; \mathbb{k}) \otimes H^*(X; \mathbb{k})$ satisfying this condition. That argument now shows that $H(\Lambda V, \bar{d})$ is a free graded commutative algebra. ΛW . Define a quasi-isomorphism $\varphi : (\Lambda W, 0) \xrightarrow{\cong} (\Lambda V, \bar{d})$ by sending a basis of W to representing cocycles in ΛV . Then φ is an isomorphism (Theorem 14.11). \square

Example 2 *A commutative model for a Sullivan fibre.*

Let $\varphi : (B, d) \rightarrow (A, d)$ be a morphism of commutative cochain algebras both of which satisfy $H^0(-) = \mathbb{k}$ and $H^1(-) = 0$. Extend φ to a minimal Sullivan model $m : (B \otimes \Lambda W, d) \xrightarrow{\cong} (A, d)$ and recall that $(\Lambda W, \bar{d}) = \mathbb{k} \otimes_B (B \otimes \Lambda W, d)$ is the Sullivan fibre of φ at an augmentation $\varepsilon : B \rightarrow \mathbb{k}$.

We construct a commutative model for $(\Lambda W, \bar{d})$ as follows. Let $(B \otimes \Lambda V, d)$ be an acyclic closure for (B, d) . Since $- \otimes_B (M, d)$ preserves quasi-isomorphisms for any (B, d) -semifree module (M, d) — cf. Proposition 6.7 — it follows that

$$(A \otimes \Lambda V, d) \xleftarrow[\cong]{id \otimes_B m} (B \otimes \Lambda V) \otimes_B (B \otimes \Lambda W) \xrightarrow[\cong]{\varepsilon \otimes_B id} (\Lambda W, \bar{d})$$

are quasi-isomorphisms; i.e.

$$(A \otimes \Lambda V, d) = A \otimes_B (B \otimes \Lambda V, d)$$

is a commutative model for the Sullivan fibre $(\Lambda W, \bar{d})$. □

Exercises

1. Let $\Phi : (B \otimes \Lambda V, d) \rightarrow (B \otimes \Lambda W, d)$ be a morphism of relative Sullivan algebras which restricts to the identity on B and let $(B \otimes \Lambda W, d) \xrightarrow{\varphi_0, \varphi_1} (A, d) \xrightarrow{\Psi} (A', d')$ be morphisms of commutative differential graded algebras. Assume that Φ and ψ are quasi-isomorphisms and that φ_0, φ_1 restrict to the same morphism $(B, d) \rightarrow (A, d)$. Prove that the following assertions are equivalent: (i) $\varphi_0 \sim \varphi_1 \text{ rel } B$, (ii) $\varphi_0 \Phi \sim \varphi_1 \Phi \text{ rel } B$, (iii) $\psi \varphi_0 \sim \psi \varphi_1 \text{ rel } B$.

2. Let $(\Lambda V, d)$ be a Sullivan minimal algebra.

a) Fix an automorphism ψ of $(\Lambda V, d)$ such that for each $x \in (\Lambda V, d)$ there is some n (depending on x) such that $(\psi - id_{\Lambda V})^n(x) = 0$. Prove that $\theta = \sum_{k=1}^{\infty} \frac{(-1)^{k-1}}{k} (\psi - id_{\Lambda V})^k$ is a derivation of $(\Lambda V, d)$, homogeneous of degree 0 which commutes with d and that for each $x \in (\Lambda V, d)$ there is some n (depending on x) such that $\theta^n(x) = 0$.

b) Prove that $\varphi = - \sum_{k=0}^{\infty} \frac{1}{(k+1)!} \theta^k$ is a linear map which commutes with d and that $\theta \varphi = \varphi \theta = \psi - id$.

c) Prove that $(\Lambda u \otimes \Lambda V, D)$ with u of degree 1 and $Dv = u \otimes \theta(v) + 1 \otimes dv$, is a minimal model of the kernel of $\epsilon_1 \cdot id - \epsilon_0 \cdot \psi : \Lambda(t, dt) \otimes (\Lambda V, d) \rightarrow (\Lambda V, d)$.

3. Let $(B \otimes \Lambda V, d)$ be a relative Sullivan algebra and consider the contractible cochain algebra $E(sV) = \Lambda sV \otimes \Lambda \hat{V}$ where $\hat{V}^i = V^i$.

a) Prove that $(B \otimes \Lambda V, d) \otimes E(sV) = (B \otimes \Lambda(V \oplus sV \oplus \hat{V}), D)$ is a relative Sullivan model.

b) Prove that the natural inclusion $\lambda_0 : (B \otimes \Lambda V, d) \hookrightarrow (B \otimes \Lambda(V \oplus sV \oplus \hat{V}), D)$ is a quasi-isomorphism.

c) Consider the degree -1 derivation S defined in $(B \otimes \Lambda(V \oplus sV \oplus \hat{V}), D)$ by $S(x) = sx, x \in V$ and $S(B) = S(sV) = S(\hat{V}) = 0$. Prove that $\theta = SD + DS$

is a degree 0 derivation and that $e^\theta = \sum_{n=0}^{\infty} \frac{\theta^n}{n!}$ is an automorphism of differential graded algebras.

d) Prove that $\lambda_1 = e^\theta \lambda_0$ satisfies $\lambda_1(x) = x + \hat{x} + \sum_{j=0}^{\infty} \frac{\theta^j}{(j+1)!} (S \circ d(x))$.

e) Let $\varphi_0, \varphi_1 : (B \otimes \Lambda V, d) \rightarrow (A, d_A)$ be morphisms of commutative differential graded algebras which restrict to the same morphism $(B, d) \rightarrow (A, d_A)$. We write $f \approx g$ if there exists a morphism of differential graded algebras $\Phi : (B \otimes \Lambda(V \oplus sV \oplus \hat{V}), D) \rightarrow (A, d_A)$ such that $\Phi \lambda_0 = \varphi_0$ and $\Phi \lambda_1 = \varphi_1$. Prove that \approx is an equivalence relation and that $\varphi_0 \approx \varphi_1$ implies that $H(\varphi_0) = H(\varphi_1)$.

f) Assume $B = Ik = H^0(A)$. Prove that $\varphi_0 \approx \varphi_1$ if and only if φ_0 this result extend to the case $H^0(B) = Ik = H^0(A)$?

15 Fibrations, homotopy groups and Lie group actions

In this section the ground ring is an arbitrary field \mathbb{k} of characteristic zero.

In this section we see how relative Sullivan algebras model fibrations. In particular, if $f : X \rightarrow Y$ is a continuous map with homotopy fibre F we construct a Sullivan model for F directly from the morphism $A_{PL}(f) : A_{PL}(Y) \rightarrow A_{PL}(X)$, provided Y is simply connected with rational homology of finite type.

We use this to construct Sullivan models for many more interesting spaces. We are also able, at last, to establish the isomorphism

$$V \xrightarrow{\cong} \text{Hom}_{\mathbb{Z}}(\pi_*(X), \mathbb{k})$$

(promised in §12 and §13(c)) between the generators of a minimal model and the dual of the homotopy groups.

Finally we apply Sullivan models to the study of principal bundles and group actions of a path connected topological group G . Our main focus is on the case when $H_*(G; \mathbb{k})$ is finite dimensional, which includes all connected Lie groups. In particular, we use Milnor's universal bundle (§2) to obtain a simple form for the Sullivan model of any principal bundle. We also consider models for group actions and see, for example, rational homotopy reasons why spaces may not support free actions of groups such as $S^3 \times SU(3)$.

Much of the material was originally developed by H. Cartan, Koszul and Weil in the context of smooth principal bundles, with the aid of principal connections and the curvature tensor. This was described in three lectures [33] [34] [102] given in Brussels in 1949 and provided one of the major clues that led to Sullivan's introduction of minimal models. Indeed, the main result announced in Koszul's lecture is the construction of (what we now call) a Sullivan model for a homogeneous space.

This section is organized into the following topics:

- (a) Models of fibrations.
- (b) Loops on spheres, Eilenberg-MacLane spaces and spherical fibrations.
- (c) Pullbacks and maps of fibrations.
- (d) Homotopy groups.
- (e) The long exact homotopy sequence.
- (f) Principal bundles, homogeneous spaces and Lie group actions.

(a) Models of fibrations.

Consider a Serre fibration of path connected spaces

$$p : X \rightarrow Y,$$

whose fibres are also path connected. Let $j : F \rightarrow X$ be the inclusion of the fibre at $y_0 \in Y$. Then A_{PL} converts the diagram

$$\begin{array}{ccc}
 F & \xrightarrow{j} & X \\
 \downarrow & & \downarrow p \\
 y_0 & \longrightarrow & Y
 \end{array}
 \quad \text{to} \quad
 \begin{array}{ccc}
 A_{PL}(F) & \xleftarrow{A_{PL}(j)} & A_{PL}(X) \\
 \uparrow & & \uparrow A_{PL}(p) \\
 \mathbb{k} & \xleftarrow{\varepsilon} & A_{PL}(Y)
 \end{array},
 \tag{15.1}$$

where ε is the augmentation corresponding to y_0 .

Observe that $H^1(A_{PL}(p))$ is injective. Indeed, since F is path connected it follows from the long exact homotopy sequence that $\pi_1(p)$ is surjective (Proposition 2.2). Hence $H_1(p; \mathbb{Z})$ is surjective (Theorem 4.19). But

$$H_1(Y; \mathbb{k}) = H_1(Y; \mathbb{Q}) \otimes_{\mathbb{Q}} \mathbb{k} = H_1(Y; \mathbb{Z}) \otimes_{\mathbb{Z}} \mathbb{k},$$

and so $H_1(p; \mathbb{k})$ is also surjective. Thus the dual map, $H^1(A_{PL}(p)) = H^1(p; \mathbb{k})$ is injective (Proposition 5.3(i)).

Since $H^1(A_{PL}(p))$ is injective, Proposition 14.3 asserts the existence of a Sullivan model for p ,

$$m : (A_{PL}(Y) \otimes \Lambda V, d) \xrightarrow{\cong} A_{PL}(X).$$

(In fact (Theorem 14.12) there is even a minimal Sullivan model for p .)

The augmentation $\varepsilon : A_{PL}(Y) \rightarrow \mathbb{k}$ defines a quotient Sullivan algebra

$$(\Lambda V, \bar{d}) = \mathbb{k} \otimes_{A_{PL}(Y)} (A_{PL}(Y) \otimes \Lambda V, d),$$

which is called the *fibre of the model at y_0* .

Since $A_{PL}(j)A_{PL}(p)$ reduces to ε in $A_{PL}(Y)$, $A_{PL}(j)m$ factors over $\varepsilon \cdot id$ to give the commutative diagram of cochain algebra morphisms

$$\begin{array}{ccc}
 A_{PL}(F) & \xleftarrow{A_{PL}(j)} & A_{PL}(X) \\
 \uparrow \bar{m} & & \uparrow m \\
 (\Lambda V, \bar{d}) & \xleftarrow{\varepsilon \cdot id} & (A_{PL}(Y) \otimes \Lambda V, d)
 \end{array}
 \tag{15.2}$$

We show now that, under mild hypotheses, \bar{m} is a quasi-isomorphism. Thus in this case $\bar{m} : (\Lambda V, \bar{d}) \xrightarrow{\cong} A_{PL}(F)$ is a Sullivan model for F : *the fibre of a model is a model of the fibre*.

Theorem 15.3 *Suppose Y is simply connected and one of the graded spaces $H_*(Y; \mathbb{k})$, $H_*(F; \mathbb{k})$ has finite type. Then*

$$\bar{m} : (\Lambda V, \bar{d}) \rightarrow A_{PL}(F)$$

is a quasi-isomorphism.

proof: Suppose first that p is a fibration. We wish to apply Theorem 7.10, with diagram (15.2) corresponding to diagram (7.9). For this we need to verify two things: first, m has to be an $A_{PL}(Y)$ -semifree resolution and second, diagram (15.1) has to be weakly equivalent to the corresponding diagram with $C^*(-)$ replacing $A_{PL}(-)$. But the first assertion is just Lemma 14.1 and the second follows from the natural cochain algebra quasi-isomorphisms $C^*(-) \xrightarrow{\cong} \bullet \xleftarrow{\cong} A_{PL}(-)$ of Corollary 10.10. Thus we may apply Theorem 7.10 and it asserts precisely that \bar{m} is a quasi-isomorphism.

Now suppose only that p is a Serre fibration. In the diagram constructed in §2(c),

$$\begin{array}{ccc}
 X & \xrightarrow{\lambda} & X \times_Y MY \\
 \downarrow p & \nearrow q & \\
 Y & &
 \end{array}
 \quad , \lambda x = (x, \text{const. path at } px),$$

λ is a map from a Serre fibration to a fibration. Since λ is a homotopy equivalence it restricts to a weak homotopy equivalence $\bar{\lambda} : F \xrightarrow{\cong} X \times_Y PY$ (Proposition 2.5(ii)).

Moreover, $A_{PL}(\lambda)$ is a surjective quasi-isomorphism. Apply the Lifting lemma 14.4 to the diagram

$$\begin{array}{ccc}
 A_{PL}(Y) & \xrightarrow{A_{PL}(q)} & A_{PL}(X \times_Y MY) \\
 \downarrow & \nearrow n & \downarrow \simeq A_{PL}(\lambda) \\
 (A_{PL}(Y) \otimes \Lambda V, d) & \xrightarrow{\bar{m}} & A_{PL}(X)
 \end{array}$$

to construct the quasi-isomorphism n extending $A_{PL}(q)$. Then $\bar{n} : (\Lambda V, \bar{d}) \rightarrow A_{PL}(X \times_Y PY)$ is a quasi-isomorphism by the argument for fibrations, and \bar{m} is the quasi-isomorphism $A_{PL}(\bar{\lambda})\bar{n}$. □

Remark In [82] the theorem is proved under the weaker hypothesis that $\pi_1(Y)$ acts locally nilpotently in each $H_i(F; \mathbb{k})$. It is in fact possible to show that this hypothesis and the hypothesis that one of $H_*(Y; \mathbb{k}), H_*(F; \mathbb{k})$ has finite type are both necessary for the conclusion of the theorem to hold. □

More generally, suppose that

$$f : X \rightarrow Y$$

is an arbitrary continuous map from a path connected topological space X to a simply connected topological space Y . Suppose further that $H_*(Y; \mathbb{k})$ has finite type. Since Y is simply connected $H^1(Y; \mathbb{k}) = 0$ and $H^1(A_{PL}(f))$ is injective. Thus f has a Sullivan model

$$m : (A_{PL}(Y) \otimes \Lambda V, d) \xrightarrow{\cong} A_{PL}(X),$$

as above. In this case the argument in the proof of Theorem 15.3 shows that the fibre $(\Lambda V, \bar{d})$ at y_0 is a Sullivan model of the homotopy fibre of f .

Return to the situation of the Serre fibration $p : X \rightarrow Y$ with which this topic began, and recall the notation of (15.1). Theorem 15.3 establishes a fundamental property for relative Sullivan models $(A_{PL}(Y) \otimes \Lambda V, d) \xrightarrow{\cong} A_{PL}(X)$. It is, however, often useful to replace $A_{PL}(Y)$ by a Sullivan model, and this is done as follows.

Choose a Sullivan model $m_Y : (\Lambda V_Y, d) \xrightarrow{\cong} A_{PL}(Y)$. Since $V_Y = \{V_Y^i\}_{i \geq 1}$ by definition, there is a unique augmentation $\varepsilon : (\Lambda V_Y, d) \rightarrow \mathbb{k}$. Construct a commutative diagram of cochain algebra morphisms

$$\begin{array}{ccccc}
 A_{PL}(Y) & \xrightarrow{A_{PL}(p)} & A_{PL}(X) & \xrightarrow{A_{PL}(j)} & A_{PL}(F) \\
 m_Y \uparrow \cong & & \cong \uparrow m & & \uparrow \bar{m} \\
 (\Lambda V_Y, d) & \xrightarrow{i} & (\Lambda V_Y \otimes \Lambda V, d) & \xrightarrow{\varepsilon \cdot id} & (\Lambda V, \bar{d})
 \end{array} \tag{15.4}$$

by requiring that

- i is the inclusion of a relative Sullivan algebra, and
- m is a Sullivan model for the composite $A_{PL}(p)m_Y$.

Then $A_{PL}(j)m$ factors over $\varepsilon \cdot id$ to yield \bar{m} .

As in Theorem 15.3, we now restrict to the case that Y is simply connected and one of $H_*(F; \mathbb{k}), H_*(Y; \mathbb{k})$ has finite type. With these hypotheses we have

Proposition 15.5 *The three morphisms m_Y, m and \bar{m} in (15.4) are all Sullivan models.*

proof: (i) *The morphism m_Y .* This is a Sullivan model by hypothesis.

(ii) *The morphism m .* This is a quasi-isomorphism by construction. Thus we have only to exhibit $(\Lambda V_Y \otimes \Lambda V, d)$ as a Sullivan algebra. Put $W = V_Y \oplus V$ and define an increasing sequence of subspaces $0 = W(-1) \subset W(0) \subset \dots \subset W$ by setting $W(\ell + 1) = \{w \in W \mid dw \in \Lambda W(\ell)\}$. It suffices to show that $W = \bigcup_{\ell} W(\ell)$.

Now $V_Y = \bigcup_k V_Y(k)$ and $V = \bigcup_k V(k)$ with $d : V_Y(k) \rightarrow \Lambda V_Y(k-1)$ and $d : V(k) \rightarrow \Lambda V_Y \otimes \Lambda V(k-1)$. Thus $V_Y(k) \subset W(k)$. If $V(k-1) \subset \bigcup_{\ell} W(\ell)$ and $v \in V(k)$ then since $dv \in \Lambda V_Y \otimes \Lambda V(k-1)$, dv is in some $\Lambda W(\ell)$. Hence v is in some $W(\ell + 1)$ and $V(k) \subset \bigcup W(\ell)$ as well.

(iii) *The morphism \bar{m} .* Write

$$A_{PL}(Y) \otimes_{(\Lambda V_Y, d)} (\Lambda V_Y \otimes \Lambda V, d) = (A_{PL}(Y) \otimes \Lambda V, d) .$$

This is a relative Sullivan algebra, and m factors as

$$(\Lambda V_Y \otimes \Lambda V, d) \xrightarrow{m_Y \otimes id} (A_{PL}(Y) \otimes \Lambda V, d) \xrightarrow{A_{PL}(p) \cdot m} A_{PL}(X).$$

But $m_Y \otimes id$ is a quasi-isomorphism (Lemma 14.2). Hence so is $A_{PL}(p) \cdot m$. Now apply Theorem 15.3. \square

Since the morphism $A_{PL}(p)m_Y$ has a minimal Sullivan model (Theorem 14.12) the relative Sullivan algebra $(\Lambda V_Y, d) \rightarrow (\Lambda V_Y \otimes \Lambda V, d)$ may be taken to be minimal. In this case $(\Lambda V, \bar{d})$ is minimal and $\bar{m} : (\Lambda V, \bar{d}) \xrightarrow{\cong} A_{PL}(F)$ is the minimal model of F . Thus Proposition 15.5 has the:

Corollary *Suppose $(\Lambda V_Y, d)$ is a Sullivan model for Y and $(\Lambda V, \bar{d})$ is the minimal Sullivan model for F . Then X has a Sullivan model of the form $(\Lambda V_Y \otimes \Lambda V, d)$ in which $(\Lambda V_Y, d)$ is a sub cochain algebra and $dv - \bar{d}v \in \Lambda^+ V_Y \otimes \Lambda V$, $v \in V$. \square*

Note: $(\Lambda V_Y \otimes \Lambda V, d)$ is minimal as a *relative* Sullivan algebra, but it is easy to make examples in which it is not minimal as a Sullivan algebra.

Proposition 15.5 has an important converse. Again suppose $p : X \rightarrow Y$ is the Serre fibration with which this topic began. Let $m_Y : (\Lambda V_Y, d) \xrightarrow{\cong} A_{PL}(Y)$ be a Sullivan model, but now suppose given

- a relative Sullivan algebra $(\Lambda V_Y, d) \rightarrow (\Lambda V_Y \otimes \Lambda W, d)$.
- a cochain algebra morphism $n : (\Lambda V_Y \otimes \Lambda W, d) \rightarrow A_{PL}(X)$ that restricts to $A_{PL}(p)m_Y$ in $(\Lambda V_Y, d)$.

Then, as above, $A_{PL}(j)n$ factors over $\varepsilon \cdot id$ to yield $\bar{n} : (\Lambda W, \bar{d}) \rightarrow A_{PL}(F)$.

As in Theorem 15.3 we suppose now that Y is simply connected and that one of $H_*(F; \mathbb{k}), H_*(Y; \mathbb{k})$ has finite type.

Proposition 15.6 *If \bar{n} is a quasi-isomorphism then so is n , i.e.,*

$$n : (\Lambda V_Y \otimes \Lambda W, d) \rightarrow A_{PL}(X)$$

is a Sullivan model for X .

proof: In the proof of Proposition 15.5 we showed that $(\Lambda V_Y \otimes \Lambda W, d)$ was a Sullivan algebra. Thus it suffices to show that n is a quasi-isomorphism.

Let $m : (\Lambda V_Y \otimes \Lambda V, d) \xrightarrow{\cong} A_{PL}(X)$ be the Sullivan model of diagram (15.4). Use Proposition 14.6 to construct a morphism of cochain algebras $\varphi : (\Lambda V_Y \otimes \Lambda W, d) \rightarrow (\Lambda V_Y \otimes \Lambda V, d)$ such that

$$\varphi = id \text{ in } \Lambda V_Y \quad \text{and} \quad m\varphi \sim n \text{ rel } (\Lambda V_Y, d) .$$

Now apply $\mathbb{k} \otimes_{\Lambda V_Y} -$ to obtain a morphism $\bar{\varphi} : (\Lambda W, \bar{d}) \rightarrow (\Lambda V, \bar{d})$ such that $\bar{m}\bar{\varphi} \sim \bar{n}$. Thus $H(\bar{m})H(\bar{\varphi}) = H(\bar{n})$. Since $H(\bar{m})$ is an isomorphism (Proposition 15.5) so is $H(\bar{\varphi})$. Put $I(k) = (\Lambda^{\geq k} V_Y \otimes \Lambda W, d)$ and $J(k) = (\Lambda^{\geq k} V_Y \otimes \Lambda V, d)$. Then φ restricts to maps $I(k) \rightarrow J(k)$. The induced maps $I(k)/I(k+1) \rightarrow J(k)/J(k+1)$ have the form

$$id \otimes \bar{\varphi} : (\Lambda^k V_Y, d_0) \otimes (\Lambda W, \bar{d}) \rightarrow (\Lambda^k V_Y, d_0) \otimes (\Lambda V, \bar{d}),$$

where $d_0 : \Lambda V_Y \rightarrow \Lambda V_Y$ is the ‘linear part’ of d . Thus these maps are all quasi-isomorphisms.

An obvious induction on k now shows that φ induces quasi-isomorphisms

$$\theta(k) : (\Lambda V_Y \otimes \Lambda W, d)/I(k) \xrightarrow{\cong} (\Lambda V_Y \otimes \Lambda V, d)/J(k)$$

for $k \geq 1$. Since $V_Y = \{V_Y^i\}_{i \geq 1}$ by the definition of a Sullivan algebra, $I(k)$ and $J(k)$ are concentrated in degrees $\geq k$. Thus we may identify $H^i(\varphi) = H^i(\theta(k))$ for $i < k$, and so φ is a quasi-isomorphism too. Since $m\varphi \sim n$, so is n . \square

(b) Loops on spheres, Eilenberg-MacLane spaces and spherical fibrations.

We apply the results of §15(a) to compute explicit Sullivan models in some important, but elementary, examples.

Example 1 *The model of the loop space ΩS^k , $k \geq 2$.*

Let $p : PS^k \rightarrow S^k$ be the path space fibration, with fibre ΩS^k . If k is odd the minimal Sullivan model for S^k has the form $m_S : (\Lambda(e), 0) \xrightarrow{\cong} A_{PL}(S^k)$. Define

$$m : (\Lambda(e, u), du = e) \rightarrow A_{PL}(PS^k)$$

by $me = A_{PL}(p)m_S e$ and $mu = \Phi$, where Φ is any cochain satisfying $d\Phi = A_{PL}(p)m_S e$. (Since PS^k is contractible any cocycle of positive degree is a coboundary.) By inspection, m is a quasi-isomorphism. Hence it follows from Proposition 15.5 that m factors to yield a minimal Sullivan model

$$\bar{m} : (\Lambda(u), 0) \xrightarrow{\cong} A_{PL}(\Omega S^k).$$

Thus $H^*(\Omega S^k; \mathbb{k})$ is the polynomial algebra on a class $[u]$ of even degree $k - 1$.

If k is even then the minimal Sullivan model for S^k has the form $m_S : (\Lambda(e, e'), de' = e^2) \xrightarrow{\cong} A_{PL}(S^k)$. In this case $A_{PL}(p)m_S$ extends to a quasi-isomorphism

$$m : (\Lambda(e, e', u, u'), du = e, du' = e' - eu) \rightarrow A_{PL}(PS^k).$$

Thus a minimal Sullivan model for ΩS^k is given by

$$\bar{m} : (\Lambda(u, u'), 0) \xrightarrow{\cong} A_{PL}(\Omega S^k).$$

In particular $H^*(\Omega S^k; \mathbb{k})$ is the tensor product of the exterior algebra on the class $[u]$ and the polynomial algebra on the class $[u']$. Here $\deg[u] = k - 1$ and $\deg[u'] = 2k - 2$.

Note that whether k is even or odd the Hilbert series (§3(e)) of $H^*(\Omega S^k; \mathbb{k})$ is given by

$$\sum_0^\infty \dim H^r(\Omega S^k; \mathbb{k}) z^r = \frac{1}{1 - z^{k-1}}. \quad \square$$

Example 2 *The model of an Eilenberg-MacLane space .*

Let X be an Eilenberg-MacLane space of type (π, n) , $n \geq 1$. Thus (cf. §4(f)) $\pi_i(X) = 0$ for $i \neq n$ and there is a specified isomorphism $\pi_n(X) \cong \pi$. Assume π is abelian (this is automatic for $n > 1$) and set $V^n = \text{Hom}(\pi, \mathbb{k})$. The Hurewicz theorem 4.19 asserts that $H_i(X; \mathbb{Z}) = 0$, $1 \leq i < n$ and that the Hurewicz map is a natural isomorphism $\pi \xrightarrow{\cong} H_n(X; \mathbb{Z})$. This extends to an isomorphism $\pi \otimes_{\mathbb{Z}} \mathbb{k} \xrightarrow{\cong} H_n(X; \mathbb{k})$, which dualizes to an isomorphism $V^n \xleftarrow{\cong} H^n(X; \mathbb{k})$.

Now suppose $\pi \otimes_{\mathbb{Z}} \mathbb{k}$ is finite dimensional. We shall show that the minimal Sullivan model of X is given by

$$m : (\Lambda V^n, 0) \xrightarrow{\cong} A_{PL}(X)$$

where m induces the isomorphism $V^n \cong H^n(X; \mathbb{k})$ above. This is clearly equivalent to the classical assertion: $H^*(X; \mathbb{k})$ is the exterior algebra on $H^n(X; \mathbb{k})$ if n is odd and is the polynomial algebra on $H^n(X; \mathbb{k})$ if n is even.

The proof is by induction on n , beginning with $n = 1$. Let $a_1, \dots, a_r \in \pi$ represent a basis of $\pi \otimes_{\mathbb{Z}} \mathbb{k}$. These elements define a homomorphism $\alpha : \mathbb{Z} \times \dots \times \mathbb{Z} \rightarrow \pi$. By Propositions 4.20 and 4.21 there is a continuous map $f : K(\mathbb{Z}^r, 2) \rightarrow K(\pi, 2)$ such that $\pi_2(f) = \alpha$. Hence $\pi_*(f) \otimes_{\mathbb{Z}} \mathbb{k}$ is an isomorphism, and so $\pi_*(f) \otimes_{\mathbb{Z}} \mathbb{Q}$ is an isomorphism. Now apply Theorem 8.6 to conclude that $H_*(\Omega f; \mathbb{Q})$ is an isomorphism, whence also $H^*(\Omega f; \mathbb{k})$ is an isomorphism.

But $\Omega K(\pi, 2)$ is an Eilenberg-MacLane space of type $(\pi, 1)$ and $\Omega K(\mathbb{Z}^r, 2)$ is an Eilenberg-MacLane space of type $(\mathbb{Z}^r, 1)$. Thus if X is any Eilenberg-MacLane space of type $(\pi, 1)$, X has the weak homotopy type of $\Omega K(\pi, 2)$, by Proposition 4.21. Similarly $S^1 \times \dots \times S^1$ has the weak homotopy type of $\Omega K(\mathbb{Z}^r, 2)$. It follows that $H^*(X; \mathbb{k}) \cong H^*(S^1 \times \dots \times S^1; \mathbb{k})$; i.e. is the exterior algebra on r generators in degree one.

Now assume $n \geq 2$ and that our result is established for $n - 1$. Let X be an Eilenberg-MacLane space of type (π, n) with $\pi \otimes_{\mathbb{Z}} \mathbb{k}$ finite dimensional. Then, as above, ΩX is an Eilenberg-MacLane space of type $(\pi, n - 1)$. By induction ΩX has a Sullivan model of the form $(\Lambda U^{n-1}, 0)$ with $U^{n-1} \cong \text{Hom}_{\mathbb{Z}}(\pi, \mathbb{k})$. In particular, $H_*(\Omega X; \mathbb{k})$ has finite type.

Let $(\Lambda W, d)$ be a minimal Sullivan model for X . Since $H_*(\Omega X; \mathbb{k})$ has finite type we may apply Proposition 15.6 to obtain a quasi-isomorphism of the form

$$(\Lambda W \otimes \Lambda U^{n-1}, d) \xrightarrow{\cong} A_{PL}(PX).$$

Moreover, since $H_i(X; \mathbb{Z}) = 0$, $1 \leq i < n$, it follows that $H^i(X; \mathbb{k}) = 0$, $1 \leq i < n$. This implies (Proposition 12.2) that $W^i = 0$, $1 \leq k < n$. By minimality, $d = 0$ in W^n .

On the other hand, the quasi-isomorphism just above shows that $H(\Lambda W \otimes \Lambda U^{n-1}, d) = \mathbb{k}$. Thus $(\Lambda W \otimes \Lambda U^{n-1}, d)$ is a contractible Sullivan algebra. It follows that $d : U^{n-1} \xrightarrow{\cong} W$ and so $W = W^n$. □

Example 3 *The rational homotopy type of $K(\mathbb{Z}, n)$.*

Let $K(\mathbb{Z}, n)$ denote an Eilenberg-MacLane space of type (\mathbb{Z}, n) , and let $a_n : S^n \rightarrow K(\mathbb{Z}, n)$ represent a generator of $\pi_n(K(\mathbb{Z}, n)) = \mathbb{Z}$. Then by the Hurewicz theorem 4.19, $H_n(a_n; \mathbb{Z}) : H_n(S^n; \mathbb{Z}) \xrightarrow{\cong} H_n(K(\mathbb{Z}, n); \mathbb{Z})$. Hence $H^n(a_n; \mathbb{Q})$ is also an isomorphism. Moreover, for $n \geq 2$, $\Omega a_n : \Omega S^n \rightarrow \Omega K(\mathbb{Z}, n) = K(\mathbb{Z}, n - 1)$ and $\pi_{n-1}(\Omega a_n)$ is an isomorphism, by the long exact homotopy sequence applied to the path space fibrations. Hence, as above, $H^{n-1}(\Omega a_n; \mathbb{Q})$ is an isomorphism.

The computations of Examples 1 and 2 above now show that $H^*(a_{2n+1}; \mathbb{Q})$ and $H^*(\Omega a_{2n+1}; \mathbb{Q})$ are isomorphisms, and so the Whitehead-Serre theorem 8.6 asserts that:

$$a_{2n+1} : S^{2n+1} \rightarrow K(\mathbb{Z}, 2n + 1) \quad \text{and} \quad \Omega a_{2n+1} : \Omega S^{2n+1} \rightarrow K(\mathbb{Z}, 2n)$$

are rational homotopy equivalences.

The reader is cautioned, however, that these maps are far from ‘integral’ homotopy equivalences. This illustrates the difference in complexity between integral and rational homotopy theory. □

Example 4 *Spherical fibrations.*

A *spherical fibration* is a fibration $p : X \rightarrow Y$ whose fibre has the homotopy type of a sphere S^k . Suppose given such a fibration with simply connected base Y .

If k is odd then the minimal model of S^k has the form $(\Lambda(e), 0)$. Hence we can apply Theorem 15.3 to obtain a model for p of the form

$$(A_{PL}(Y) \otimes \Lambda(e), d) \xrightarrow{\cong} A_{PL}(X), \quad de = z \in A_{PL}(Y).$$

If k is even then the model of S^k has the form $(\Lambda(e, e'), \bar{d}e' = e^2)$. Thus p has a model of the form $(A_{PL}(Y) \otimes \Lambda(e, e'), d)$ with $de \in A_{PL}(Y)$ and $de' = e^2 + a \otimes e + b$ for some elements $a, b \in A_{PL}(Y)$. The condition $d^2e' = 0$ now implies that $2de = -da$. Replace e by $e + \frac{1}{2}a$ to obtain a model in which $de = 0$ and $de' = e^2 + z$, some $z \in A_{PL}(Y)$. In summary, $A_{PL}(p)$ has a model of the form

$$(A_{PL}(Y) \otimes \Lambda(e, e'), d) \xrightarrow{\cong} A_{PL}(X), \quad \begin{aligned} de &= 0 \\ de' &= e^2 + z, \quad z \in A_{PL}(Y). \end{aligned}$$

Note that in both cases z is a cocycle in $A_{PL}(Y)$ whose cohomology class $[z]$ is determined by the fibration. In particular this class is zero if and only if $A_{PL}(X)$ is weakly equivalent to $A_{PL}(Y \times S^k)$. However in the case of even spheres an easy calculation shows that $H^*(X; \mathbb{k}) \cong H^*(Y; \mathbb{k}) \otimes H^*(S^k)$ as $H^*(Y; \mathbb{k})$ -modules.

Finally suppose the spherical fibration arises as the unit sphere bundle of a vector bundle $\xi : E \rightarrow Y$ of rank $k + 1$. (For facts about vector bundles and characteristic classes the reader is referred to [128] and [69] [70].) If k is odd the class $[z]$ is the Euler class of ξ , essentially by definition.

If k is even then $[z] = \frac{1}{4}p_{2k}(\xi)$, where $p_{2k}(\xi)$ denotes the $2k^{\text{th}}$ -Pontrjagin class of ξ . In fact, we can use $p : X \rightarrow Y$ to pull the vector bundle ξ back to

a vector bundle ξ_X over X , and ξ_X is the direct sum of a trivial line bundle and a vector bundle η of rank k . Let χ denote the Euler class of η . Then $\chi^2 = p_{2k}(\eta) = H^*(p)p_{2k}(\xi)$. Moreover, if S_y^k is the fibre of $p: X \rightarrow Y$ at y , then η restricts to the tangent bundle of S_y^k . Hence, by a result of Hopf, $\langle \chi, [S_y^k] \rangle = 2$.

On the other hand, it follows directly from the model that $H^*(p)[z] = [e]^2$ with $\langle [e], [S_y^k] \rangle = 1$, and that this condition determines $[z]$ uniquely. Hence $[z] = \frac{1}{4}p_{2k}(\xi)$. □

Example 5 *Complex projective spaces.*

The inclusions $S^1 \subset S^2 \subset \dots \subset S^r \subset \dots$ define a CW complex $S^\infty = \bigcup_r S^r$, and it follows from the Cellular approximation theorem 1.2 that $\pi_r(S^\infty) = \pi_r(S^{r+1}) = 0$, $r \geq 0$. Regard S^{2n+1} as the unit sphere in \mathbb{C}^n . Complex multiplication defines a free action of S^1 on each S^{2n+1} with orbit space the complex projective space $\mathbb{C}P^n$. Similarly S^1 acts on S^∞ with orbit space $\mathbb{C}P^\infty$, and the S^1 -bundle $S^{2n+1} \rightarrow \mathbb{C}P^n$ is the restriction of the S^1 -bundle $S^\infty \rightarrow \mathbb{C}P^\infty$.

From the long exact homotopy sequence deduce that $\mathbb{C}P^\infty \simeq K(\mathbb{Z}, 2)$ and hence that $H^*(\mathbb{C}P^\infty; \mathbb{Q}) = \Lambda u$, with $\deg u = 2$ (Example 2, above). Similarly, $\pi_*(\mathbb{C}P^n) \otimes \mathbb{Q} = \mathbb{Q}u \oplus \mathbb{Q}x$ with $\deg u = 2$ and $\deg x = 2n + 1$. Since $\mathbb{C}P^n$ is a $2n$ -dimensional CW complex it has no cohomology in degree $2n + 2$. Thus its minimal Sullivan model must have the form $\Lambda(u, x; dx = u^{n+1})$. In particular, $\mathbb{C}P^n$ is formal with cohomology algebra $\Lambda u/u^{n+1}$. □

(c) Pullbacks and maps of fibrations.

Suppose given any commutative square of continuous maps

$$\begin{array}{ccc} Z & \xrightarrow{g} & X \\ q \downarrow & & \downarrow p \\ A & \xrightarrow{f} & Y \end{array}$$

in which p and q are Serre fibrations, Z and X are path connected and A and Y are simply connected. Choose basepoints a_0 and y_0 so that $f(a_0) = y_0$ and denote by $\bar{g}: \bar{F} \rightarrow F$ the restriction of g to a map from the fibre of q at a_0 to the fibre of p at y_0 . Finally, assume that $H_*(-; \mathbb{k})$ has finite type for one of \bar{F} , A and for one of F, Y .

Choose Sullivan models $m_Y: (\Lambda V_Y, d) \rightarrow A_{PL}(Y)$ and $n_A: (\Lambda W_A, d) \xrightarrow{\cong} A_{PL}(A)$, and let

$$\psi: (\Lambda V_Y, d) \rightarrow (\Lambda W_A, d)$$

be a Sullivan representative for f ; i.e., $n_A \psi \sim A_{PL}(f)m_Y$. The Sullivan models extend ((15.4) and Proposition 15.5) to commutative diagrams

$$\begin{array}{ccccc}
 A_{PL}(Y) & \xrightarrow{A_{PL}(p)} & A_{PL}(X) & \longrightarrow & A_{PL}(F) \\
 m_Y \uparrow \simeq & & \simeq \uparrow m & & \simeq \uparrow \bar{m} \\
 (\Lambda V_Y, d) & \longrightarrow & (\Lambda V_Y \otimes \Lambda V, d) & \xrightarrow{\varepsilon \cdot id} & (\Lambda V, \bar{d})
 \end{array}$$

and

$$\begin{array}{ccccc}
 A_{PL}(A) & \xrightarrow{A_{PL}(q)} & A_{PL}(Z) & \longrightarrow & A_{PL}(\bar{F}) \\
 n_A \uparrow \simeq & & \simeq \uparrow n & & \simeq \uparrow \bar{n} \\
 (\Lambda W_A, d) & \longrightarrow & (\Lambda W_A \otimes \Lambda W, d) & \xrightarrow{\varepsilon \cdot id} & (\Lambda W, \bar{d})
 \end{array} \tag{15.7}$$

in which all the vertical arrows are Sullivan models.

Suppose first that we have been able to choose ψ so that

$$n_A \psi = A_{PL}(f)m_Y .$$

Then the pushout construction of §14(a) yields the morphism

$$\xi = A_{PL}(q)n_A \cdot A_{PL}(g)m : (\Lambda W_A, d) \otimes_{(\Lambda V_Y, d)} (\Lambda V_Y \otimes \Lambda V, d) \longrightarrow A_{PL}(Z) .$$

This may be written as $\xi : (\Lambda W_A \otimes \Lambda V, d) \longrightarrow A_{PL}(Z)$, and fits in the commutative diagram

$$\begin{array}{ccccc}
 A_{PL}(A) & \longrightarrow & A_{PL}(Z) & \longrightarrow & A_{PL}(\bar{F}) \\
 n_A \uparrow \simeq & & \uparrow \xi & & \uparrow A_{PL}(\bar{g})\bar{m} \\
 \Lambda W_A & \longrightarrow & (\Lambda W_A \otimes \Lambda V, d) & \xrightarrow{\varepsilon \cdot id} & (\Lambda V, \bar{d})
 \end{array}$$

Thus we may apply Proposition 15.6 to deduce

Proposition 15.8 *If $H^*(\bar{g}) : H^*(F; \mathbb{k}) \longrightarrow H^*(\bar{F}; \mathbb{k})$ is an isomorphism (in particular if $Z \longrightarrow A$ is the pullback of $X \longrightarrow Y$), then ξ is a Sullivan model for Z . \square*

Now consider the more general situation where $\eta_A \psi \sim A_{PL}(f)m_Y$. Here we shall extend ψ to a commutative diagram

$$\begin{array}{ccccc}
 (\Lambda V_Y, d) & \longrightarrow & (\Lambda V_Y \otimes \Lambda V, d) & \xrightarrow{\varepsilon \cdot id} & (\Lambda V, \bar{d}) \\
 \psi \downarrow & & \downarrow \varphi & & \downarrow \bar{\varphi} \\
 (\Lambda W_A, d) & \longrightarrow & (\Lambda W_A \otimes \Lambda W, d) & \xrightarrow{\varepsilon \cdot id} & (\Lambda W, \bar{d})
 \end{array} \tag{15.9}$$

in which φ and $\bar{\varphi}$ are Sullivan representatives for g and for \bar{g} ; i.e. $n\varphi \sim A_{PL}(g)m$ and $\bar{n}\bar{\varphi} \sim A_{PL}(\bar{g})\bar{m}$.

Denote by $\varepsilon_0, \varepsilon_1 : - \otimes \Lambda(t, dt) \rightarrow -$ the morphisms $(id \cdot \varepsilon_0) : t \mapsto 0$ and $(id \cdot \varepsilon_1) : t \mapsto 1$. Let

$$[A_{PL}(Z) \otimes \Lambda(t, dt)] \times_{A_{PL}(Z)} (\Lambda W_A \otimes \Lambda W, d)$$

be the fibre product with respect to the morphisms

$$A_{PL}(Z) \otimes \Lambda(t, dt) \xrightarrow{\varepsilon_0} A_{PL}(Z) \xleftarrow{n} (\Lambda W_A \otimes \Lambda W, d)$$

and let ρ^L and ρ^R denote the projections of the fibre product on the left and right factors. Now ρ^R is surjective and $\ker \rho^R = \ker \varepsilon_0$. Hence $H(\ker \rho^R) = 0$ and ρ^R is a quasi-isomorphism. It follows that $\varepsilon_0 \rho^L = n \rho^R$ is a quasi-isomorphism and therefore so is ρ^L .

Let $\Psi : (\Lambda V_Y, d) \rightarrow A_{PL}(A) \otimes \Lambda(t, dt)$ be a homotopy from $n_A \psi$ to $A_{PL}(f)m_Y$. Then we have the commutative diagram

$$\begin{array}{ccc} (\Lambda V_Y, d) & \xrightarrow{(A_{PL}(q)\Psi, \psi)} & [A_{PL}(Z) \otimes \Lambda(t, dt)] \times_{A_{PL}(Z)} (\Lambda W_A \otimes \Lambda W, d) \\ \downarrow & & \downarrow \varepsilon_1 \rho^L \\ (\Lambda V_Y \otimes \Lambda V, d) & \xrightarrow{A_{PL}(g)m} & A_{PL}(Z) \end{array} \tag{15.10}$$

Since ρ^L is a quasi-isomorphism so is $\varepsilon_1 \rho^L$. Moreover, if $z \in A_{PL}(Z)$ then $\varepsilon_0(z \otimes t) = 0$ and so $(z \otimes t, 0)$ is an element in the fibre product. Now $\varepsilon_1 \rho^L(z \otimes t, 0) = \varepsilon_1(z \otimes t) = z$, which shows that $\varepsilon_1 \rho^L$ is surjective. By the Lifting lemma 14.4 there is a morphism

$$\Gamma = (\Phi, \varphi) : (\Lambda V_Y \otimes \Lambda V, d) \rightarrow [A_{PL}(Z) \otimes \Lambda(t, dt)] \times_{A_{PL}(Z)} (\Lambda W_A \otimes \Lambda W, d)$$

extending $(A_{PL}(q)\Psi, \psi)$ and such that $\varepsilon_1 \rho^L \Gamma = A_{PL}(g)m$.

In particular $\varepsilon_0 \Phi = n\varphi$ and $\varepsilon_1 \Phi = \varepsilon_1 \rho^L \Gamma = A_{PL}(g)m$. Thus Φ is a homotopy from $n\varphi$ to $A_{PL}(g)m$ and $\varphi : (\Lambda V_Y \otimes \Lambda V, d) \rightarrow (\Lambda W_A \otimes \Lambda W, d)$ is a Sullivan representative for g . Moreover φ extends ψ and so the left hand square of (15.9) commutes.

Finally, set

$$\bar{\varphi} = k \otimes_{\psi} \varphi : (\Lambda V, \bar{d}) \rightarrow (\Lambda W, \bar{d}).$$

By construction, the right hand square of (15.9) commutes. Moreover, just as m and n factor to give \bar{m} and \bar{n} so Φ factors to define a morphism

$$\bar{\Phi} : (\Lambda V, \bar{d}) \rightarrow A_{PL}(\bar{F}) \otimes \Lambda(t, dt)$$

such that $\varepsilon_0 \bar{\Phi} = \bar{n} \bar{\varphi}$ and $\varepsilon_1 \bar{\Phi} = A_{PL}(\bar{g}) \bar{m}$. Thus $\bar{n} \bar{\varphi} \sim A_{PL}(\bar{g}) \bar{m}$ and $\bar{\varphi}$ is a Sullivan representative for \bar{g} . This completes the construction of (15.8).

Remark As noted in §15(a), the models in (15.7) may be chosen so that $(\Lambda V_Y, d) \rightarrow (\Lambda V_Y \otimes \Lambda V, d)$ and $(\Lambda W_A, d) \rightarrow (\Lambda W_A \otimes \Lambda W, d)$ are *minimal* relative Sullivan algebras. In this case $(id \cdot \varphi)$ is a quasi-isomorphism between minimal relative Sullivan algebras. Thus Theorem 14.11 asserts that

$$id \cdot \varphi : (\Lambda W_A \otimes \Lambda V, d) \xrightarrow{\cong} (\Lambda W_A \otimes \Lambda W, d)$$

is an isomorphism of cochain algebras.

Example 1 *The free loop space X^{S^1} .*

Let X be a simply connected topological space with rational homology of finite type. The free loop space, X^{S^1} , is the topological space of all continuous maps $S^1 \rightarrow X$. We may identify these as the continuous maps $f : I \rightarrow X$ such that $f(0) = f(1)$ and this defines an inclusion $i : X^{S^1} \rightarrow X^I$. Moreover

$$\begin{array}{ccc} X^{S^1} & \xrightarrow{i} & X^I \\ p \downarrow & & \downarrow q \\ X & \xrightarrow{\Delta} & X \times X \end{array} \quad , \quad \begin{array}{l} p(g) = g(0), \\ q(f) = (f(0), f(1)), \\ \Delta(x) = (x, x) \end{array}$$

is a pullback diagram of fibrations. Finally, the constant map $I \rightarrow pt$ defines a homotopy equivalence $X^I \leftarrow X^{pt} = X$ that converts the diagonal Δ to q .

We may now apply the results above to compute a Sullivan model for X^{S^1} as follows. Let $(\Lambda V, d)$ be a minimal Sullivan model for X . Then multiplication

$$\mu : (\Lambda V, d) \otimes (\Lambda V, d) \rightarrow (\Lambda V, d)$$

is a Sullivan representative for Δ as follows from Example 2, §12(a). Convert this to a relative Sullivan algebra $(\Lambda V \otimes \Lambda V \otimes \Lambda W, d) \xrightarrow{\cong} (\Lambda V, d)$ and then by Proposition 15.8, $(\Lambda V, d) \otimes_{\Lambda V \otimes \Lambda V} (\Lambda V \otimes \Lambda V \otimes \Lambda W, d) = (\Lambda V \otimes \Lambda W, d)$ is a Sullivan model for X^{S^1} .

In this case we can carry out these computations explicitly. Define \bar{V} by $\bar{V}^k = V^{k+1}$ and consider the acyclic Sullivan algebra $(E(\bar{V}), d) = \Lambda \bar{V} \otimes \Lambda d\bar{V}$ constructed in §12(b). In $(\Lambda V, d) \otimes (E(\bar{V}), d)$ define derivations s of degree -1 and θ of degree zero by $sv = \bar{v}$, $s\bar{v} = sd\bar{v} = 0$, and $\theta = sd + ds$. (Here the isomorphism $\bar{V}^k = V^{k+1}$ is denoted by $\bar{v} \rightarrow v$.) Then an isomorphism

$$\varphi : \Lambda V \otimes \Lambda V \otimes \Lambda \bar{V} \xrightarrow{\cong} (\Lambda V, d) \otimes (E(\bar{V}), d)$$

is given by $\varphi(v \otimes 1 \otimes 1) = v$, $\varphi(1 \otimes v \otimes 1) = \sum_0^\infty \frac{\theta^n v}{n!}$ and $\varphi(1 \otimes 1 \otimes \bar{v}) = \bar{v}$.

Now θ is a derivation satisfying $\theta d = d\theta$ in $\Lambda V \otimes E(\bar{V})$. It follows that $e^\theta = \sum_{n=0}^\infty \frac{\theta^n}{n!}$ is an automorphism of this graded differential algebra. Hence $\varphi(1 \otimes dv \otimes 1) = d\varphi(1 \otimes v \otimes 1)$. This implies that the inclusion,

$$\lambda : (\Lambda V, d) \otimes (\Lambda V, d) \rightarrow (\Lambda V \otimes \Lambda V \otimes \Lambda \bar{V}, d)$$

is a relative Sullivan algebra. The quasi-isomorphism $(\Lambda V \otimes \Lambda V \otimes \Lambda \bar{V}, d) \xrightarrow{\cong} (\Lambda V, d) \otimes (E(\bar{V}), d) \xrightarrow{\cong} (\Lambda V, d)$ converts λ into multiplication in ΛV , and so λ is a Sullivan model for the multiplication morphism. Thus, as described above,

$$(\Lambda V \otimes \Lambda \bar{V}, \bar{d}) = (\Lambda V, d) \otimes_{\Lambda V \otimes \Lambda V} (\Lambda V \otimes \Lambda V \otimes \Lambda \bar{V}, d)$$

is a Sullivan model for X^{S^1} .

It remains to compute \bar{d} . Observe that $s = 0$ in \bar{V} and $d\bar{V}$ and hence that $s^2 = 0$ since s^2 is a derivation. It follows that

$$\varphi(1 \otimes v \otimes 1) = v + d\bar{v} + \sum_{n=1}^{\infty} \frac{(sd)^n}{n!} v, \quad v \in V$$

and hence that $s' = \varphi^{-1}s\varphi$ is the derivation in $\Lambda V \otimes \Lambda V \otimes \Lambda \bar{V}$ given by

$$s'(v \otimes 1 \otimes 1) = s'(1 \otimes v \otimes 1) = 1 \otimes 1 \otimes \bar{v} \quad \text{and} \quad s'(1 \otimes 1 \otimes \bar{v}) = 0.$$

Thus in $\Lambda V \otimes \Lambda V \otimes \Lambda \bar{V}$,

$$\begin{aligned} d(1 \otimes 1 \otimes \bar{v}) &= \varphi^{-1}(d\bar{v}) = 1 \otimes v \otimes 1 - \varphi^{-1} \left(v + \sum_{n=1}^{\infty} \frac{(sd)^n}{n!} v \right) \\ &= (1 \otimes v - v \otimes 1) \otimes 1 - \sum_{n=1}^{\infty} \frac{(s'd)^n}{n!} (v \otimes 1 \otimes 1). \end{aligned}$$

Finally, let s'' be the derivation in $\Lambda V \otimes \Lambda \bar{V}$ given by $s''v = \bar{v}$ and $s''\bar{v} = 0$. Then an immediate computation from this formula gives the differential d in $\Lambda V \otimes \Lambda \bar{V}$ as:

$$\bar{d}v = dv \quad \text{and} \quad \bar{d}\bar{v} = -s''dv.$$

This defines the Sullivan model for X^{S^1} explicitly in terms of $(\Lambda V, d)$. □

(d) Homotopy groups.

Suppose $f : X \rightarrow Y$ is a continuous map between simply connected spaces, and let

$$m_X : (\Lambda V_X, d) \rightarrow A_{PL}(X) \quad \text{and} \quad m_Y : (\Lambda V_Y, d) \rightarrow A_{PL}(Y)$$

be minimal Sullivan models. Let $\varphi_f : (\Lambda V_Y, d) \rightarrow (\Lambda V_X, d)$ be a Sullivan representative for f ; i.e., $m_X \varphi_f \sim A_{PL}(f) m_Y$. Its linear part,

$$Q(f) : V_Y \rightarrow V_X$$

is independent of the choice of φ_f (§13(c)).

In §13(c) we introduced the bilinear map

$$\langle -; - \rangle : V_X \times \pi_*(X) \rightarrow \mathbb{k}$$

defined by $Q(a)v = \langle v; \alpha \rangle e$, where $a : S^k \rightarrow X$ represents α and $(\Lambda(e, \dots), d)$ is the minimal model of S^k . This determines the linear map

$$\nu_X : V_X \rightarrow \text{Hom}_{\mathbb{Z}}(\pi_*(X), \mathbb{k})$$

given by $(\nu_X v)(\alpha) = \langle v; \alpha \rangle$. Given $f : X \rightarrow Y$, we have $\langle Q(f)v; \alpha \rangle = \langle v; \pi_*(f)\alpha \rangle$, $v \in V_Y$, $\alpha \in \pi_*(X)$. It follows that ν_X is a natural transformation:

$$\nu_X \circ Q(f) = \text{Hom}_{\mathbb{Z}}(\pi_*(f), \mathbb{k}) \circ \nu_Y.$$

The minimal Sullivan models approach to rational homotopy theory is successful because ν_Y identifies the generating space of the model with the dual of the homotopy groups of the space:

Theorem 15.11 *Suppose X is simply connected and $H_*(X; \mathbb{k})$ has finite type. Then the bilinear map $V_X \times \pi_*(X) \rightarrow \mathbb{k}$ is non-degenerate. Equivalently,*

$$\nu_X : V_X \xrightarrow{\cong} \text{Hom}_{\mathbb{Z}}(\pi_*(X), \mathbb{k})$$

is an isomorphism.

Remark 1 It follows from Theorem 15.11 that if $H_*(X; \mathbb{Q})$ has finite type so does $\pi_*(X) \otimes \mathbb{Q}$, since in this case the Sullivan model has finite type. Conversely, if $\pi_*(X) \otimes \mathbb{Q}$ has finite type then the procedure for constructing a rational cellular model $X_{\mathbb{Q}}$ (§9) shows that $H_*(X; \mathbb{Q})$ has finite type. Indeed if we know by induction that the r -skeleton of $X_{\mathbb{Q}}$ is finite we can conclude that it has rational homology (and hence rational homotopy) of finite type. Thus the $(r+1)$ -skeleton is constructed by adjoining finitely many rational cells.

Remark 2 Theorem 14.11 asserts that a morphism φ between minimal models is an isomorphism if and only if it is a quasi-isomorphism. Since φ is an isomorphism if and only if its linear part $Q(\varphi)$ is an isomorphism we recover the

rational Whitehead-Serre theorem for continuous maps $f : X \rightarrow Y$; $\pi_*(f) \otimes \mathbb{Q}$ is an isomorphism if and only if $H_*(f; \mathbb{Q})$ is an isomorphism.

proof of Theorem 15.11: Fix $k \geq 2$.

To show that $\nu_X : V_X^k \xrightarrow{\cong} \text{Hom}_{\mathbb{Z}}(\pi_k(X), \mathbb{k})$ we let r be the least integer such that $\pi_r(X) \neq 0$, and argue by induction on $k - r$.

If $k = r$ then the Hurewicz homomorphism is an isomorphism $\pi_r(X) \xrightarrow{\cong} H_r(X; \mathbb{Z})$ (Theorem 4.19). On the other hand, since $H^i(X; \mathbb{k}) = 0$ for $1 \leq i \leq r - 1$ the minimal model for X satisfies $V_X^i = 0$, $1 \leq i \leq r - 1$ (Proposition 12.2). Thus $H(m_X) : V_X^r \xrightarrow{\cong} H^r(X; \mathbb{k})$. It is immediate from the definition that these isomorphisms identify ν_X with the isomorphism $H^r(X; \mathbb{k}) \xrightarrow{\cong} \text{Hom}_{\mathbb{Z}}(H_r(X; \mathbb{Z}), \mathbb{k})$. Thus when $k = r$, ν_X is an isomorphism.

Suppose now that $k > r$. Observe first that if $f : X \rightarrow Y$ is a weak homotopy equivalence then $H^*(f; \mathbb{k})$ is an isomorphism. It follows that a Sullivan representative φ_f is a quasi-isomorphism and hence an isomorphism (Theorem 14.11). Thus $Q(f)$, as well as $\pi_*(f)$, are isomorphisms. Thus by naturality, we may replace X by any space of the same weak homotopy type.

In particular, we may suppose X is a CW complex. Let K be an Eilenberg-MacLane space of type $(\pi_r(X), r)$. Choose a continuous map $g : X \rightarrow K$ such that $\pi_r(g) = \text{identity}$ (Proposition 4.21). Factor g (as in §2(c)) in the form

$$\begin{array}{ccc} X & \xrightarrow{\lambda} & X \times_K MK \\ & \searrow g & \swarrow p \\ & & K \end{array}$$

with λ a homotopy equivalence and p a fibration. Again, use naturality to replace X by $X \times_K MK$. Thus we may assume there is a fibration

$$p : X \rightarrow K$$

such that $\pi_r(p)$ is an isomorphism.

In Example 2 of §15(b) we showed that the minimal model of K has the form $(\Lambda V^r, 0) \xrightarrow{\cong} A_{PL}(K)$. In particular, $H^*(K; \mathbb{k})$ has finite type and so Theorem 15.3 and its consequences apply to the fibration p .

Now let $j : F \rightarrow X$ be the inclusion of the fibre of p . By the long exact homotopy sequence (Proposition 2.2), $\pi_r(F) = 0$.

Because $\pi_i(F) = 0$, $1 \leq i \leq r$, a minimal model of F has the form $m_F : (\Lambda V_F, \bar{d}) \xrightarrow{\cong} A_{PL}(F)$ with $V_F^i = 0$, $1 \leq i \leq r$ (Proposition 12.2). Thus dia-

gram (15.4) for p becomes

$$\begin{array}{ccccc}
 A_{PL}(K) & \xrightarrow{A_{PL}(p)} & A_{PL}(X) & \xrightarrow{A_{PL}(j)} & A_{PL}(F) \\
 \uparrow \simeq & & \uparrow m \simeq & & \uparrow \simeq m_F \\
 (\Lambda V^r, 0) & \xrightarrow{i} & (\Lambda V^r \otimes \Lambda V_F, d) & \xrightarrow{\varepsilon \cdot id} & (\Lambda V_F, \bar{d})
 \end{array}$$

Since V_F is concentrated in degrees $> r$ the Sullivan algebra $(\Lambda V^r \otimes \Lambda V_F, d)$ is necessarily minimal. Lift m_X to a quasi-isomorphism $\varphi : (\Lambda V_X, d) \xrightarrow{\simeq} (\Lambda V^r \otimes \Lambda V_F, d)$ such that $m\varphi \sim m_X$ and conclude from Theorem 14.11 that φ is an isomorphism. Since $H^*(X; \mathbb{k})$ has finite type so does ΛV_X (Proposition 12.2(iii)). Hence so does ΛV_F and, a fortiori, $H^*(F; \mathbb{k})$.

Finally $m_F(\varepsilon \cdot id)\varphi = A_{PL}(j)m\varphi \sim A_{PL}(j)m_X$. This identifies $(\varepsilon \cdot id)\varphi$ as a Sullivan representative for j . In particular, $Q^k(j)$ is the isomorphism $Q^k(\varepsilon \cdot id)Q^k(\varphi)$. The long exact homotopy sequence for p shows that $\pi_k(j)$ is also an isomorphism. Thus ν_X and ν_F are identified in degree k by naturality, and ν_X is an isomorphism in degree k . \square

Recall (§13(c)) that the projection $\Lambda^+ V_X \rightarrow V_X$ induces a linear map $\zeta : H^+(\Lambda V_X) \rightarrow V_X$. From the commutative diagram at the end of §13(c) we deduce the

Corollary *The isomorphisms $\nu_X : V_X \xrightarrow{\simeq} \text{Hom}_{\mathbb{Z}}(\pi_*(X), \mathbb{k})$ and $H(m_X) : H(\Lambda V_X) \xrightarrow{\simeq} H^*(X; \mathbb{k})$ identify ζ with the dual of the Hurewicz homomorphism.* \square

Example 1 *Rational homotopy groups of spheres.*

Let $\iota \in \pi_n(S^n)$ be the class represented by the identity map of S^n . Then

$$\pi_n(S^{2k+1}) \otimes \mathbb{Q} = \begin{cases} \mathbb{Q} \cdot \iota & , n = 2k + 1 \\ 0 & , \text{otherwise} \end{cases}$$

and

$$\pi_n(S^{2k}) \otimes \mathbb{Q} = \begin{cases} \mathbb{Q} \cdot \iota & , n = 2k \\ \mathbb{Q} \cdot [\iota, \iota]_W & , n = 4k - 1 \\ 0 & , \text{otherwise.} \end{cases}$$

Indeed in the first case the minimal model is $(\Lambda(e), 0)$ and $\langle e; \iota \rangle = 1$. In the second the minimal model is $(\Lambda(e, e'), de' = e^2)$. Again $\langle e; \iota \rangle = 1$ while Proposition 13.16 gives $\langle e'; [\iota, \iota]_W \rangle = -\langle e^2; \iota, \iota \rangle = -2$. Now apply Theorem 15.11 \square

Example 2 *The model $(\Lambda(e_0, e_1, x), dx = e_0e_1)$, $\mathbb{k} = \mathbb{Q}$.*

In Example 2 of §13(e) we considered the space $X = (S^3 \vee S^3) \cup_f (D_0^8 \amalg D_1^8)$ where the two 8-cells were attached respectively by $[a_0, [a_0, a_1]_W]_W$ and

$[a_1, [a_1, a_0]_w]_w$. The minimal Sullivan model of X was shown to have the form $(\Lambda V, d) = (\Lambda(e_0, e_1, x, w, w_0, \dots), d)$, where $dx = e_0 e_1$, $dw = e_0 e_1 x$ and the w_i have higher degree.

Thus a linear function $V^{10} \rightarrow \mathbb{Q}$ is defined by $w \mapsto 1$. By Theorem 15.11 there is a continuous map $b : S^{10} \rightarrow X$ such that $Q(b)w = \lambda e$, some non-zero $\lambda \in \mathbb{Q}$. Put

$$Y = X \cup_b D^{11} = (S^3 \vee S^3) \cup_f (D_0^8 \amalg D_1^8) \cup_b D^{11}.$$

According to §13(d) the cochain algebra $(\Lambda V \oplus ku, d_\beta)$ is a commutative model for Y , where $\beta = [b] \in \pi_{10}(X)$. A straightforward calculation shows that a quasi-isomorphism

$$(\Lambda V \oplus ku, d_\beta) \xrightarrow{\cong} (\Lambda(e_0, e_1, x), d)$$

is given by $u \mapsto -\lambda^{-1} e_0 e_1 x$, $w \mapsto 0$, $w_i \mapsto 0$, $i \geq 0$. Thus $(\Lambda(e_0, e_1, x), d)$ is the minimal Sullivan model for Y . In particular,

$$\pi_n(Y) \otimes \mathbb{Q} = \begin{cases} \mathbb{Q} \oplus \mathbb{Q} & , n = 3 \\ \mathbb{Q} & , n = 5 \\ 0 & , \text{otherwise.} \end{cases}$$

Observe that the inclusion $(\Lambda(e_0, e_1, x), d) \rightarrow (\Lambda(e_0, e_1, x, w, \dots), d)$ is a Sullivan representative for the inclusion $i : X \rightarrow Y$. This shows that $Q(i)$ is injective and so the dual map

$$\pi_*(i) \otimes \mathbb{Q} : \pi_*(X) \otimes \mathbb{Q} \rightarrow \pi_*(Y) \otimes \mathbb{Q}$$

is surjective.

Finally, we show that the homotopy fibre, F , of i has the same minimal Sullivan model as a wedge of spheres, and compute its cohomology. Extend $(\Lambda(e_0, e_1, x), d)$ to the contractible Sullivan algebra $(\Lambda(e_0, e_1, x, v_0, v_1, y), d)$ by setting $dv_0 = e_0$, $dv_1 = e_1$ and $dy = x + e_0 v_1$.

It follows from (14.6) that $\mathbb{Q} \otimes_{\Lambda(e_0, e_1, x)} (\Lambda V, d)$ is a Sullivan model for F . Form the pushout

$$(A, d) = (\Lambda(e_0, e_1, x, v_0, v_1, y), d) \otimes_{\Lambda(e_0, e_1, x)} (\Lambda V, d)$$

as described in §14(a). On the one hand, (A, d) may be regarded as a relative Sullivan algebra

$$(\Lambda(e_0, e_1, x, v_0, v_1, y), d) \rightarrow (\Lambda(e_0, \dots, y) \otimes \Lambda(w, w_0, \dots), d).$$

Since $\varepsilon : (\Lambda(e_0, \dots, y), d) \rightarrow \mathbb{Q}$ is a quasi-isomorphism, so is $\varepsilon \otimes - : (A, d) \xrightarrow{\cong} (\Lambda(w, w_0, \dots), d)$. Thus (A, d) is a Sullivan model for F .

On the other hand, (A, d) may be regarded as a relative Sullivan algebra

$$(\Lambda V, d) \rightarrow (\Lambda V \otimes \Lambda(v_0, v_1, y), d).$$

Now apply the quasi-isomorphism $(\Lambda V, d) \rightarrow (\Lambda(e_0, e_1, x)/e_0e_1x, d)$ to obtain a quasi-isomorphism

$$(A, d) \xrightarrow{\cong} (C, d) = ([\Lambda(e_0, e_1, x)/e_0e_1x] \otimes \Lambda(v_0, v_1, y), d).$$

Since $H(\Lambda(e_0, \dots, y), d) = \mathbb{Q}$, the short exact sequence

$$0 \rightarrow ((\mathbb{Q}e_0e_1x) \otimes \Lambda(v_0, v_1, y), 0) \rightarrow (\Lambda(e_0, e_1, x, v_0, v_1, y), d) \rightarrow (C, d) \rightarrow 0$$

allows us to compute $H(C)$, which is isomorphic to $H^*(F; \mathbb{Q})$. In particular, the Hilbert series of $H^*(F; \mathbb{Q})$ is given by

$$H^*(F; \mathbb{Q})(z) = 1 + \frac{z^{10}}{(1-z^2)^2(1-z^4)}.$$

More precisely, the cocycles $e_1xv_0^k v_1^\ell y^m \in C$, $k \geq 1$, $\ell \geq 0$, $m \geq 0$ represent a basis of $H^+(C)$. Since these cocycles multiply each other to zero it follows that $H^+(C) \cdot H^+(C) = 0$. Moreover these cocycles define a quasi-isomorphism $(H(C), 0) \rightarrow (C, d)$ of cochain algebras. Hence $(H(C), 0)$ is also a commutative model for F , while by Proposition 3.4 it is also a commutative model for a wedge of spheres. \square

Example 3 *The Quillen plus construction*

Let X be a path connected topological space whose fundamental group, $\pi_1(X)$ is finitely generated and such that every element in $\pi_1(X)$ is a product of commutators. Then $H_1(X; \mathbb{Z}) = 0$, by the Hurewicz theorem 4.19.

Adjoin to X finitely many two cells e_1^2, \dots, e_n^2 to kill a set of generators of $\pi_1(X)$. The Cellular approximation theorem 1.2 implies that $\pi_1(X) \rightarrow \pi_1(X \cup \bigcup_i e_i^2)$ is surjective. Hence $X \cup \left(\bigcup_i e_i^2\right)$ is simply connected. On the other hand, since $H_1(X; \mathbb{Z}) = 0$, the long exact homology sequence for the pair $\left(X \cup \left(\bigcup_i e_i^2\right), X\right)$ shows that there are homology classes $\alpha_1, \dots, \alpha_n \in H_2\left(X \cup \bigcup_i e_i^2; \mathbb{Z}\right)$ that project to the classes $[e_1^2], \dots, [e_n^2]$ in the relative homology.

Since $X \cup \left(\bigcup_i e_i^2\right)$ is simply connected the Hurewicz Theorem implies that the α_i can be represented by maps $a_i : S^2 \rightarrow X \cup \left(\bigcup_i e_i^2\right)$. Attach three cells by these maps to create the topological space $Y = X \cup \left(\bigcup_i e_i^2\right) \cup \left(\bigcup_j e_j^3\right)$. This is called the *Quillen plus construction on X* .

This construction has two important properties. Firstly Y is simply connected. Secondly the inclusion $X \rightarrow Y$ induces an isomorphism of homology, as follows

immediately from the long exact homology sequence for (Y, X) . In particular in the case X is an Eilenberg-MacLane space (and hence has no higher homotopy groups) the higher homotopy groups of Y are invariants of the group $\pi_1(X)$; its *algebraic K-groups*.

Now suppose the rational homology $H_*(X; \mathbb{Q})$ has finite type. Then we can construct the minimal Sullivan model $m_X : (\Lambda V, d) \xrightarrow{\cong} A_{PL}(X)$ and, as in Proposition 12.2, V will be a graded vector space of finite type. However, unlike the situation in Theorem 15.11, the graded vector space V may have little to do with $\pi_*(X)$.

On the other hand, the inclusion $i : X \rightarrow Y$ induces a quasi-isomorphism $A_{PL}(i) : A_{PL}(Y) \rightarrow A_{PL}(X)$. Hence a Sullivan representative is an isomorphism of minimal models (Theorem 14.11), which exist by Theorem 14.12. Thus Theorem 15.11 provides an isomorphism

$$\nu_Y : V \xrightarrow{\cong} \text{Hom}_{\mathbb{Z}}(\pi_*(Y), \mathbb{Q}).$$

In particular the rational K -groups of $\pi_1(X)$ may be computed directly from $A_{PL}(X)$. When X is a smooth manifold we may also use $A_{DR}(X)$ as observed in §12(e). □

Example 4 *Smooth manifolds and smooth maps.*

Let X be a smooth manifold. In §11 we showed that $A_{DR}(X)$ is connected by natural quasi-isomorphisms to $A_{PL}(X; \mathbb{R})$. Thus a minimal Sullivan model $(\Lambda V, d) \xrightarrow{\cong} A_{DR}(X)$ is a Sullivan model for X (over \mathbb{R}). In particular, if X is simply connected and $H_*(X; \mathbb{R})$ has finite type (e.g. if X is compact) then there is an isomorphism

$$\nu_X : V \xrightarrow{\cong} \text{Hom}_{\mathbb{Z}}(\pi_*(X), \mathbb{R})$$

(Theorem 15.11). This shows that the real homotopy groups, as well as the cohomology algebra, may be computed from $A_{DR}(X)$.

Now let $\varphi : X \rightarrow Y$ be a smooth map. In the same way, a Sullivan representative for $A_{DR}(\varphi)$ is a Sullivan representative for φ . Moreover, if Y is simply connected and has real homology of finite type and if

$$m : (A_{DR}(Y) \otimes \Lambda W, d) \xrightarrow{\cong} A_{DR}(X)$$

is a Sullivan model for $A_{DR}(\varphi)$, then we can apply Theorem 15.3 to identify $(\Lambda W, \bar{d})$ as a Sullivan model for the homotopy fibre of φ . (This, of course, need not be a manifold!) □

(e) **The long exact homotopy sequence .**

Let $p : X \rightarrow Y$ be a Serre fibration of path connected spaces, and with path connected fibre $j : F \rightarrow X$. Assume that Y is simply connected and that all spaces have homology $H_*(-; \mathbb{k})$ of finite type.

In §15(a) we constructed the diagram, labelled (15.4):

$$\begin{array}{ccccc}
 A_{PL}(Y) & \xrightarrow{A_{PL}(p)} & A_{PL}(X) & \xrightarrow{A_{PL}(j)} & A_{PL}(F) \\
 \uparrow m_Y \simeq & & \uparrow m & & \uparrow \bar{m} \\
 (\Lambda V_Y, d) & \xrightarrow{i} & (\Lambda V_Y \otimes \Lambda V, d) & \xrightarrow{id \cdot \varepsilon} & (\Lambda V, \bar{d})
 \end{array}$$

in which all three vertical morphisms are Sullivan models. Moreover we can (and do here) take $(\Lambda V_Y, d)$ and $(\Lambda V, \bar{d})$ to be minimal. However, the central Sullivan algebra, $(\Lambda(V_Y \oplus V), d)$ need not be minimal. Let d_0 be the linear part of d : it is the differential in $V \oplus V_Y$ defined by $dx - d_0x \in \Lambda^{\geq 2}(V \oplus V_Y)$, $x \in V_0 \oplus V_Y$. Then i and $id \cdot \varepsilon$ restrict to a short exact sequence of cochain complexes,

$$0 \longrightarrow (V_Y, 0) \xrightarrow{i} (V_Y \oplus V, d_0) \xrightarrow{id \cdot \varepsilon} (V, 0) \longrightarrow 0. \tag{15.12}$$

This construction is *natural* in the following sense. Given a map of Serre fibrations, consider the Sullivan representatives constructed in (15.8). Their linear parts define a morphism of the short exact sequences (15.12) and of the corresponding long exact cohomology sequences.

Recall now from Theorem 14.9 (applied with $B = \mathbb{k}$) that $(\Lambda(V_Y \oplus V), d) \cong (\Lambda W, d) \otimes \Lambda(U \oplus dU)$ with $(\Lambda W, d)$ a minimal Sullivan algebra and $\Lambda(U \oplus dU)$ contractible. This defines a quasi-isomorphism $\lambda : (\Lambda W, d) \xrightarrow{\cong} (\Lambda(V_Y \oplus V), d)$, and $m_X = m\lambda : (\Lambda W, d) \xrightarrow{\cong} A_{PL}(X)$ is its minimal Sullivan model. Moreover (Proposition 14.13), the linear part of λ induces an isomorphism $W \xrightarrow{\cong} H(V_Y \oplus V, d_0)$. Use this to replace $H(V_Y \oplus V, d_0)$ by W in the long exact cohomology sequence of (15.12), which then takes the form

$$\dots \longrightarrow V_Y^k \longrightarrow W^k \longrightarrow V^k \xrightarrow{d_0} V_Y^{k+1} \longrightarrow \dots$$

Proposition 15.13 *Suppose X and F are also simply connected. Then the isomorphisms ν_Y, ν_X and ν_F of Theorem 15.11 identify the long exact cohomology sequence above, up to sign, with the dual of the long exact homotopy sequence of the Serre fibration $p : X \rightarrow Y$.*

proof: The linear maps $V_Y \rightarrow W$ and $W \rightarrow V$ are identified with $\text{Hom}_{\mathbb{Z}}(\pi_*(p), \mathbb{k})$ and $\text{Hom}_{\mathbb{Z}}(\pi_*(j), \mathbb{k})$, as follows easily from the definitions. To check that the two connecting homomorphisms are identified we will verify that

$$\langle d_0v; \alpha \rangle = (-1)^{k+1} \langle v; \partial_*\alpha \rangle, \quad v \in V^k, \alpha \in \pi_{k+1}(Y).$$

Fix k and α , and let $a : S^{k+1} \rightarrow Y$ represent α . Recall the path space fibration $\hat{p} : PS^{k+1} \rightarrow S^{k+1}$. Since PS^{k+1} is contractible, $\text{const} \sim a\hat{p}$. Cover this homotopy with a homotopy $PS^{k+1} \times I \rightarrow X$ from the constant map to some

map $b : PS^{k+1} \rightarrow X$. Thus $pb = a\hat{p}$ and so b restricts to a map $c : \Omega S^{k+1} \rightarrow F$. By naturality, it is sufficient to establish our formula for the fibration $PS^{k+1} \rightarrow S^{k+1}$ and $\alpha = [id_{S^{k+1}}]$.

In this case, as we saw in Example 1, §12(a) $(\Lambda V_Y, d) = (\Lambda(e), 0)$ or $(\Lambda(e, e'), de' = e^2)$, depending on whether $k + 1$ is odd or even. Moreover, as shown in Example 1, §15(b), $(\Lambda V, \bar{d}) = (\Lambda(u), 0)$ or $(\Lambda(u, u'), 0)$ and the differential in $(\Lambda V_Y \otimes \Lambda V, d)$ is given by $du = e$ and $du' = e' - eu$. In this case u is a basis for V^k and $d_0u = e$, so that we are reduced to proving

$$\langle e; [id_{S^{k+1}}] \rangle = (-1)^{k+1} \langle u; \partial_*[id_{S^{k+1}}] \rangle.$$

Recall the continuous map $\theta : S^k \times I \rightarrow S^{k+1}$ whose picture is given in Example 5, §1. Regard θ as a based homotopy from the constant map to itself and lift this through $\hat{p} : PS^{k+1} \rightarrow S^{k+1}$ to a based homotopy $\tilde{\theta} : S^k \times I \rightarrow PS^{k+1}$ from the constant map to a map $h : S^k \rightarrow \Omega S^{k+1}$. Then $[h] = \partial_*[id_{S^{k+1}}]$.

Let $z_k \in C_*(S^k; \mathbb{Z})$ be a cycle representing $[S^k]$ — cf. §4(d). If ι is the identity map of I , regarded as a singular 1-simplex then $C_*(\theta)EZ(z_k \otimes \iota)$ is a cycle representing $[S^{k+1}]$. Set $w = C_*(\tilde{\theta})EZ(z_k \otimes \iota)$. A quick computation shows that $C_*(p)w$ is the cycle representing $[S^{k+1}]$ and that dw is a cycle in $C^*(\Omega S^{k+1}; \mathbb{Z})$ representing $H_*(h)[S^k]$. Thus w projects to a relative cycle $\bar{w} \in C_*(PS^{k+1}, \Omega S^{k+1}; \mathbb{Z})$. Moreover $C_*(p) : C_*(PS^{k+1}, \Omega S^{k+1}; \mathbb{Z}) \rightarrow C_*(S^{k+1}, pt; \mathbb{Z})$ and we have, by construction that

$$H_*(p)[\bar{w}] = [S^{k+1}] \quad \text{and} \quad \partial_*[\bar{w}] = H_*(h)[S^k];$$

here ∂_* also denotes the connecting homomorphism in homology for the pair $(PS^{k+1}, \Omega S^{k+1})$.

On the other hand, the quasi-isomorphisms

$$\begin{array}{ccccccc} 0 & \longrightarrow & A_{PL}(PS^{k+1}, \Omega S^{k+1}) & \longrightarrow & A_{PL}(\Omega S^{k+1}) & \longrightarrow & 0 \\ & & \uparrow \simeq & & \uparrow \simeq & & \\ 0 & \longrightarrow & (\Lambda^+ V_Y \otimes \Lambda V, d) & \longrightarrow & (\Lambda V_Y \otimes \Lambda V, d) & \longrightarrow & (\Lambda V, \bar{d}) \longrightarrow 0 \end{array}$$

identify the connecting homomorphisms in the two long exact cohomology sequences. Moreover (cf. (10.13)) the upper long exact sequence is, up to sign, dual to the long exact singular homology sequence. It follows that

$$\langle H(m)[e \otimes 1], [\bar{w}] \rangle = \langle H^*(p)H(m_Y)[e], [\bar{w}] \rangle = \langle H(m_Y)[e], [S^{k+1}] \rangle .$$

Finally, since $du = e \otimes 1$,

$$\langle H(m)[e \otimes 1], [\bar{w}] \rangle = \langle \partial^* H(\bar{m})[u], [\bar{w}] \rangle = (-1)^{k+1} \langle H(\bar{m})[u], H_k(h)[S^k] \rangle .$$

But the Hurewicz homomorphism converts the duality between V and π_* to the duality between cohomology and homology. Thus

$$\langle H(m_Y)[e], [S^{k+1}] \rangle = \langle e; [id_{S^{k+1}}] \rangle$$

and

$$\langle H(\bar{m})[u], H_k(h)[S^k] \rangle = \langle u, [h] \rangle = \langle u, \partial_*[id_{S^{k+1}}] \rangle. \quad \square$$

Return to the setup described at the start of this topic and recall that a linear map $\zeta : H^+(\Lambda V, \bar{d}) \rightarrow V$ is defined by $\zeta[z] - z \in \Lambda^{\geq 2}V$, z a cocycle in Λ^+V . When F is simply connected this is dual to the Hurewicz homomorphism, hur_F , (§15(d)) and so $d_0\zeta$ is dual to $hur_F \partial_*$. We need this without the restriction that F be simply connected:

Proposition 15.14 *The linear maps $d_0\zeta$ and $hur_F \partial_*$ are dual, up to sign, if F is path connected and Y is simply connected.*

proof: Let $z \in (\Lambda V)^k$ be a \bar{d} -cocycle and let $\alpha \in \pi_{k+1}(Y)$ be represented by $a : S^{k+1} \rightarrow Y$. We show that

$$\langle d_0\zeta z; \alpha \rangle = (-1)^{k+1} \langle H(\bar{m})[z], hur_F \partial_* \alpha \rangle.$$

Use the pullback of the fibration via a , and naturality, to reduce to the case $Y = S^{k+1}$ and $a = id_{S^{k+1}}$. Then $(\Lambda V_Y, d) = (\Lambda(e, \dots), d)$ and $dz = d_0\zeta z = \lambda e$, for some $\lambda \in \mathbb{k}$.

Now the argument used in 15.13 for the path space fibration (with the last paragraph suppressed) applies verbatim to give the proposition. \square

(f) Principal bundles, homogeneous spaces and Lie group actions.

Let G be a path connected topological group with finite dimensional rational homology. (This holds for all Lie groups.) As observed in Example 3, §12(a), the minimal Sullivan model of G has the form

$$m_G : (\Lambda P_G, 0) \xrightarrow{\cong} A_{PL}(G),$$

where P_G is a finite dimensional graded vector space concentrated in odd degrees. Let x_1, \dots, x_r be a basis of P_G with degree $x_i = 2\ell_i + 1$. Since G is weakly equivalent to ΩB_G (Proposition 2.10), there are maps $f_i : S^{2\ell_i+1} \rightarrow G$ such that $\langle H(m_G)x_j, H_*(f_i)[S^{2\ell_i+1}] \rangle = \delta_{ij}$ (apply Proposition 15.14). Thus we recover a theorem of Serre: *multiplication in G defines a rational homotopy equivalence*

$$\prod_{i=1}^r S^{2\ell_i+1} \rightarrow G.$$

Now consider the universal principal bundle $p_G : E_G \rightarrow B_G$ constructed in §2(d). As described in §15(e) it determines a long exact sequence

$$\rightarrow V_{B_G}^k \rightarrow W^k \rightarrow P_G^k \xrightarrow{d_0} V_{B_G}^{k+1} \rightarrow$$

connecting the generating spaces for minimal Sullivan models of B_G , E_G and G . But $H^*(E_G) = \mathbb{k}$ and so $W = 0$. Thus $d_0 : P_G^* \xrightarrow{\cong} V_{B_G}^{*+1}$. It follows that V_{B_G} is

finite dimensional and concentrated in even degrees. Thus ΛV_{B_G} is concentrated in even degrees and so the differential must be zero. We have thus established

Proposition 15.15 *The minimal Sullivan model for B_G has the form*

$$m_{B_G} : (\Lambda V_{B_G}, 0) \xrightarrow{\cong} A_{PL}(B_G),$$

where $V_{B_G}^* \cong P_G^{*+1}$. In particular, $H^*(B_G)$ is the finitely generated polynomial algebra, ΛV_{B_G} . □

Since G is weakly equivalent to ΩB_G , B_G is simply connected. Since $(\Lambda V_{B_G}, 0)$ is the Sullivan model of B_G , it follows from Theorem 15.11 that $V_{B_G} \cong \text{Hom}_{\mathbb{Z}}(\pi_*(B_G), \mathbb{k})$. Thus $\pi_*(B_G) \otimes \mathbb{Q}$ is finite dimensional and concentrated in even degrees and, for degree reasons, all the rational Whitehead products for B_G vanish.

Let y_1, \dots, y_r be the basis of V_{B_G} corresponding to the basis x_1, \dots, x_r of P_G , and define a contractible Sullivan algebra $(\Lambda V_{B_G} \otimes \Lambda P_G, d)$ by setting $dx_i = y_i$ and $dy_i = 0$. Since $H^*(E_G) = \mathbb{k}$, there is a commutative diagram of morphisms,

$$\begin{array}{ccccc} A_{PL}(B_G) & \xrightarrow{A_{PL}(p_G)} & A_{PL}(E_G) & \longrightarrow & A_{PL}(G) \\ \uparrow m_{B_G} \cong & & \uparrow m & & \uparrow \bar{m} \\ (\Lambda V_{B_G}, 0) & \longrightarrow & (\Lambda V_{B_G} \otimes \Lambda P_G, d) & \longrightarrow & (\Lambda P_G, 0) \end{array}$$

defined by setting $mx_i = \Phi_i$, where $\Phi_i \in A_{PL}(E_G)$ is any element satisfying $d\Phi_i = A_{PL}(p_G)m_{B_G}y_i$. Here m is a quasi-isomorphism by inspection and so this is the special case of diagram (15.4) for the universal bundle. In particular (Proposition 15.5), \bar{m} is a quasi-isomorphism. Thus we may take $m_G = \bar{m}$.

Finally, suppose $p : X \rightarrow Y$ is any principal G -bundle over a simply connected CW complex, Y . (The following could be extended to the non-simply connected case.) This bundle is the pullback of the universal bundle $p_G : E_G \rightarrow B_G$ over a map $f : Y \rightarrow B_G$ as shown in §2(e). The cohomology classes in $\text{Im } H^*(f)$ are called the *characteristic classes* of the fibre bundle. Regard the basis y_1, \dots, y_r of V_{B_G} as cohomology classes of B_G , so that $H^*(f)y_1, \dots, H^*(f)y_r$ are characteristic classes.

Then a Sullivan representative

$$\varphi_f : (\Lambda V_{B_G}, 0) \rightarrow (\Lambda V_Y, d)$$

for f is characterized by the condition: $\varphi_f y_i$ is a cocycle in ΛV_Y representing $H^*(f)y_i$, $1 \leq i \leq r$. It defines the relative Sullivan algebra

$$(\Lambda V_Y, d) \rightarrow (\Lambda V_Y \otimes \Lambda P_G, d), \quad dx_i = \varphi_f y_i;$$

which is just the pushout $(\Lambda V_Y, d) \otimes_{(\Lambda V_{B_G}, d)} (\Lambda V_{B_G} \otimes \Lambda P_G, d)$. Thus the Remarks in §15(c) give a commutative diagram

$$\begin{array}{ccccc}
 A_{PL}(Y) & \xrightarrow{A_{PL}(p)} & A_{PL}(X) & \longrightarrow & A_{PL}(G) \\
 m_Y \uparrow \simeq & & m_X \uparrow \simeq & & \simeq \uparrow m_G \\
 (\Lambda V_Y, d) & \longrightarrow & (\Lambda V_Y \otimes \Lambda P_G, d) & \longrightarrow & (\Lambda P_G, 0).
 \end{array}$$

This identifies $(\Lambda V_Y \otimes \Lambda P_G, d)$ as a Sullivan model for X .

Example 1 *Homogeneous spaces.*

Let $K \subset G$ be a closed subgroup of a connected Lie group G . Right multiplication by K is an action on G and the projection $p : G \rightarrow G/K$ onto the orbit space is the projection of a principal K -bundle [70]. The space (in fact, a smooth manifold) G/K is called a *homogeneous space*.

Define a right action of K on $E_K \times G$ by setting $(x, a) \cdot b = (xb, b^{-1}a)$. The inclusion $j : K \rightarrow G$ defines an obvious continuous map $E(j) : E_K \rightarrow E_G$. The formula $(x, a) \mapsto (E(j)x) \cdot a$ defines a continuous map $E_K \times G \rightarrow E_G$ which factors to yield a continuous map $f : (E_K \times G)/K \rightarrow E_G$. Thus we obtain a commutative diagram

$$\begin{array}{ccc}
 (E_K \times G)/K & \xrightarrow{f} & E_G \\
 q \downarrow & & \downarrow p_G \\
 B_K & \xrightarrow{B(j)} & B_G
 \end{array}$$

in which q and $B(j)$ are the maps of orbit spaces corresponding respectively to the projection $E_K \times G \rightarrow E_K$ and to $E(j)$. As in §2(e), q is the projection of a principal G -bundle which the diagram exhibits as the pullback of the universal bundle over $B(j)$.

Suppose now that K is connected too and use Sullivan models for B_K and B_G to identify

$$H^*(B(j)) : (\Lambda V_{B_G}, 0) \rightarrow (\Lambda V_{B_K}, 0)$$

as a Sullivan representative for $B(j)$. If y_1, \dots, y_r is a basis for V_{B_G} corresponding to a basis x_1, \dots, x_r of P_G then the discussion above exhibits

$$(\Lambda V_{B_K} \otimes \Lambda P_G, d), \quad dx_i = H^*(B(j)) y_i$$

as a Sullivan model for $(E_K \times G)/K$.

On the other hand the projection $E_K \times G \rightarrow G$ induces (as in Proposition 2.9) a weak homotopy equivalence $q' : (E_K \times G)/K \rightarrow G/K$. Thus G/K and $(E_K \times G)/K$ have isomorphic Sullivan models and we obtain

Proposition 15.16 *The Sullivan algebra $(\Lambda V_{B_K} \otimes \Lambda P_G, d)$ defined by $dx_i = H^*(B(j)) y_i$ and $d = 0$ in V_{B_K} is a Sullivan model for G/K . \square*

Example 2 *The Borel construction; application to free actions.*

Let G be a connected Lie group. An action of G on a space X determines the fibre bundle

$$q : X_G \longrightarrow B_G$$

with fibre X , as described in §2(e). Now fibre bundles are Serre fibrations (Proposition 2.6) and B_G is simply connected. Thus we may apply Proposition 15.5 to this Serre fibration to obtain

$$\begin{array}{ccccc} A_{PL}(B_G) & \xrightarrow{A_{PL}(q)} & A_{PL}(X_G) & \xrightarrow{A_{PL}(j)} & A_{PL}(X) \\ \uparrow m_{B_G} \simeq & & \uparrow \simeq m & & \uparrow \simeq m_X \\ (\Lambda V_{B_G}, 0) & \longrightarrow & (\Lambda V_{B_G} \otimes \Lambda V_X, D) & \longrightarrow & (\Lambda V_X, d) \end{array}$$

in which m_X is a minimal Sullivan model for X . Thus the Borel construction, X_G , has a Sullivan model of the form $(\Lambda V_{B_G} \otimes \Lambda V_X, D)$ above. \square

Proposition 15.17 *If a compact connected Lie group acts smoothly and freely on a manifold X then the Sullivan algebra $(\Lambda V_{B_G} \otimes \Lambda V_X, D)$ is a Sullivan model for the orbit space X/G . In particular, $H^i(\Lambda V_{B_G} \otimes \Lambda V_X, D) = 0, \quad i > \dim X - \dim G$.*

proof: In this case the projection $X \rightarrow X/G$ is the projection of a principal G bundle [REF] and Proposition 2.9 provides a weak homotopy equivalence $q' : X_G \rightarrow X/G$. This implies the first assertion. Since X/G is a manifold and $\dim X/G = \dim X - \dim G$, the second assertion follows. \square

Example 3 *Matrix Lie groups.*

Compact matrix Lie groups

$$SO(n) \subset M(n; \mathbb{R}), \quad SU(n) \subset M(n; \mathbb{C}), \quad Q(n) \subset M(n; \mathbb{H})$$

are defined as follows, where \mathbb{R}, \mathbb{C} , and \mathbb{H} are the reals, complex numbers and quaternions. Both \mathbb{C} and \mathbb{H} have a conjugations: $\overline{\alpha + \beta i} = \alpha - \beta i$ and $\overline{\alpha + \beta i + \gamma j + \delta k} = \alpha - \beta i - \gamma j - \delta k$. Then

$$\begin{aligned} SO(n) &= \{A \mid A^t = A^{-1} \text{ and } \det A = 1\} \\ SU(n) &= \{A \mid \overline{A}^t = A^{-1} \text{ and } \det A = 1\} \\ Q(n) &= \{A \mid \overline{A}^t = A^{-1}\}. \end{aligned}$$

The linear action of $SO(n)$ in \mathbb{R}^n restricts to a transitive action on S^{n-1} which identifies $SO(n)/SO(n-1) \xrightarrow{\cong} S^{n-1}$. Similar remarks apply in the other cases, to give principal bundles:

$$\begin{aligned} SO(n-1) &\rightarrow SO(n) \rightarrow S^{n-1}, \\ SU(n-1) &\rightarrow SU(n) \rightarrow S^{2n-1} \quad \text{and} \\ Q(n-1) &\rightarrow Q(n) \rightarrow S^{4n-1}. \end{aligned}$$

In particular $SO(2) \cong S^1$, $SU(2) \cong S^3$ and $Q(1) \cong S^7$.

On the other hand, for any connected Lie group G with Sullivan model $(\Lambda P_G, 0)$ we have $P_G \cong \pi_*(G) \otimes \mathbb{k}$ as graded vector spaces (since G is weakly equivalent to ΩB_G). Thus the long exact homotopy sequences for the Serre fibrations give an easy inductive calculation of the Sullivan models of the classical compact groups:

$$\begin{aligned} SO(2n+1) &: \Lambda(x_1, \dots, x_n) && , \deg x_i = 4i - 1. \\ SO(2n) &: \Lambda(x_1, \dots, x_{n-1}, x'_n) && , \deg x_i = 4i - 1, \deg x'_n = 2n - 1. \\ SU(n) &: \Lambda(x_2, \dots, x_n) && , \deg x_i = 2i - 1. \\ Q(n) &: \Lambda(x_1, \dots, x_n) && , \deg x_i = 4i - 1. \end{aligned}$$

□

Example 4 *A fibre bundle with fibre $S^3 \times SU(3)$ that is not principal.*

The model for $SU(3)$ is $\Lambda(x_2, x_3)$ with $\deg x_2 = 3$ and $\deg x_3 = 5$. Thus the model for its classifying space is $\Lambda(y_2, y_3)$ with $\deg y_2 = 4$ and $\deg y_3 = 6$. These elements are dual to maps $S^4 \xrightarrow{a} B_{SU(3)}$ and $S^6 \xrightarrow{b} B_{SU(3)}$.

Consider the continuous map

$$f : S^3 \times S^3 \rightarrow (S^3 \times S^3)/(S^3 \vee S^3) = S^6 \xrightarrow{b} B_{SU(3)}$$

and use it to pull the universal bundle back to a principal $SU(3)$ -bundle $p : X \rightarrow S^3 \times S^3$. Let

$$q : X \rightarrow S^3$$

be the composite of p with projection on the left factor.

It is a relatively easy exercise to exhibit p as a smooth fibre bundle, and a theorem of Ehresmann then asserts that q is a smooth fibre bundle too. (It is trivial that q is a Serre fibration.) The fibre of q is the compact Lie group $S^3 \times SU(3)$. Now the discussion above gives a model for the principal bundle p , from which we find that q is represented by

$$(\Lambda u, 0) \rightarrow (\Lambda(u, v, x_2, x_3), d)$$

with $\deg u = \deg v = 3$, $du = dv = dx_2 = 0$ and $dx_3 = uv$. This is not the model of a principal bundle and so q is not principal.

In Example 3, §14(d), we constructed a space $Y = S^3 \vee S^3 \cup D^8 \cup D^8 \cup D^{10}$. By inspection $S^3 \times Y$ has the same Sullivan model as X . It is, in fact, easy to see that X and $S^3 \times Y$ have the same rational homotopy type. □

Example 5 *Non-existence of free actions.*

Consider the manifold X of Example 4. We observed there that a certain bundle $q : X \rightarrow S^3$ with fibre $S^3 \times SU(3)$ was not principal. Now we establish a stronger assertion: X does not admit any free smooth $S^3 \times SU(3)$ action.

In fact we show more: X has no free smooth $S^3 \times S^3$ action. Indeed let $G = S^3 \times S^3$. For any G action the Borel construction has a Sullivan model of the form

$$(\Lambda(a_1, a_2) \otimes \Lambda(u, v, x_2, x_3), D) \rightarrow (\Lambda(u, v, x_2, x_3), d)$$

with $\deg a_i = 4$, and $Da_i = 0$. For degree reasons $Dx_3 = dx_3 = uv$ and $Du, Dv \in \Lambda(a_1, a_2)$. Thus

$$0 = D^2x_3 = Du \otimes v - Dv \otimes u,$$

whence $Du = Dv = 0$. We also have $Dx_2 \in \Lambda(a_1, a_2)$ and these calculations now show that $\Lambda(a_1, a_2)/(Dx_2)$ is a subalgebra of $H^*(X_G)$.

This subalgebra cannot be finite dimensional and hence (Proposition 15.17) the action cannot be free. □

Exercises

1 Compute a relative Sullivan model for:

- a) the Hopf map $\gamma : S^7 \rightarrow S^4$,
- b) the composite $S^3 \times S^4 \rightarrow S^3 \wedge S^4 \cong S^7 \xrightarrow{\gamma} S^4$.

2 Consider a Serre fibration of path connected spaces $F \xrightarrow{j} X \rightarrow Y$. Prove the following assertions:

- a) If $Y = S^3 \vee S^4 \vee S^5$ and $H^*(F; \mathbb{Q}) = \Lambda(x_1, x_2, \dots, x_k)/(x_1^2, x_2^2, \dots, x_k^2)$ with each x_i of even degree then $X \simeq_{\mathbb{Q}} Y \times F$.
- b) If $H^*(F; \mathbb{Q}) = \Lambda(x)/(x^k)$ with x of even degree and $k \geq 2$ then the morphism $H^*(j) : H^*(X; \mathbb{Q}) \rightarrow H^*(F; \mathbb{Q})$ is onto and $H^*(X; \mathbb{Q})$ is isomorphic as an $H^*(Y; \mathbb{Q})$ -module to the free module $H^*(Y; \mathbb{Q}) \otimes H^*(F; \mathbb{Q})$.

3. Consider for $n \geq 1$, the group of unitary matrices: $A \in U(n)$ if $\overline{A}^t = A^{-1}$.

Let $U(k) \hookrightarrow U(n+k)$ be the inclusion $A \mapsto \begin{pmatrix} A & 0 \\ 0 & I_n \end{pmatrix}$

a) Using the fibration $U(n-1) \rightarrow U(n) \rightarrow U(n)/U(n-1) = S^{2n-1}$ prove that $U(n)$ admits a minimal model of the form $(\Lambda(x_1, x_3, \dots, x_{2n-1}), 0)$ with $\deg x_i = i$. Compute the minimal model of the classifying space $BU(n)$.

b) Using the fibration $S^{2k-1} \rightarrow U(n+k)/U(k) \rightarrow U(n+k)/U(k-1)$ prove, by induction on n , that $H^*(U(n+k)/U(k)); \mathbb{Q} \cong \Lambda(x_{2k+1}, x_{2k+3}, \dots, x_{2n+2k-1})$.

4. Let F be the homotopy fiber of the inclusion of the n -skeleton into the classifying space $X = BU(n)$. It is known that $H^*(F; \mathbb{Q})$ is the cohomology of the "Lie algebra of formal vector fields on n -variables". Compute this cohomology.

5. Recall that for $n \geq 1$, the n^{th} -Postnikov approximation $f_n : X \rightarrow X^n$ of a topological space X is defined by the following properties : $\pi_k(f_n)$ is an isomorphism for $k \leq n$ and $\pi_k(X^n) = 0$ for $k \geq n + 1$. Construct a relative minimal model for f_n . Deduce that a Sullivan minimal model of the homotopy fibre of f_n is quasi-isomorphic to the quotient differential graded algebra $\mathbb{I}k \otimes_{\wedge V \leq n} (\wedge V, d)$.
6. Let X be a 1-connected finite CW complex and $n \geq 1$ and let φ be a Sullivan representative of a continuous map $f : K(\mathbb{Z}, 2n) \rightarrow X$. Prove that φ is homotopic to the trivial map.

16 The loop space homology algebra

In this section the ground ring is an arbitrary field \mathbb{k} of characteristic zero.

In this section we consider based topological spaces, (X, x_0) , and we shall frequently assume that

$$X \text{ is simply connected and } H_*(X; \mathbb{k}) \text{ has finite type,} \quad (16.1)$$

even though a number of the results can, with additional work, be established for a larger class of spaces. We shall also simplify notation and write

$$\pi_*(X) \otimes \mathbb{k} = \pi_*(X) \otimes_{\mathbb{Z}} \mathbb{k}.$$

As described in §2, composition of paths defines a continuous associative multiplication $\mu : \Omega X \times \Omega X \rightarrow \Omega X$ in the (Moore) loop space ΩX and makes the path space fibration $PX \rightarrow X$ into an ΩX -fibration. The identity element of ΩX is the constant path e_0 of length zero at x_0 , and we shall always use e_0 as the basepoint of ΩX .

The connecting homomorphism for the path space fibration is an isomorphism

$$\partial_* : \pi_*(X) \xrightarrow{\cong} \pi_{*-1}(\Omega X),$$

since PX is contractible. *In particular, $\pi_1(\Omega X)$ is abelian.*

The geometric product $\mu : \Omega X \times \Omega X \rightarrow \Omega X$ makes $C_*(\Omega X; \mathbb{k})$ into a chain algebra via the Eilenberg-Zilber morphism EZ, as described in §8(a). The multiplication in the homology algebra, $H_*(\Omega X; \mathbb{k})$, is given by

$$\alpha \cdot \beta = H_*(\mu)H(EZ)(\alpha \otimes \beta), \quad \alpha, \beta \in H_*(\Omega X; \mathbb{k}),$$

and the graded algebra $H_*(\Omega X; \mathbb{k})$ is called the *loop space homology algebra* of X .

In this section we establish some strong structural results both for the cohomology algebra $H^*(\Omega X; \mathbb{k})$ and the homology algebra $H_*(\Omega X; \mathbb{k})$ for any space X satisfying (16.1). *When X is a finite complex*, however, its loop space homology has many more remarkable and beautiful properties. Developing these is one of the main objectives of Part V of this text.

The structural results to be shown here are summarized by:

- $H^*(\Omega X; \mathbb{k})$ is a free graded commutative algebra.
- The Hurewicz homomorphism is an isomorphism

$$\pi_*(\Omega X) \otimes \mathbb{k} \xrightarrow{\cong} P_*(\Omega X)$$

onto the primitive space for ΩX .

- The graded algebra $H_*(\Omega X; \mathbb{k})$ can be computed explicitly from the graded vector space $\pi_*(X) \otimes \mathbb{k}$ and the Whitehead product map

$$[\ , \]_W : (\pi_*(X) \otimes \mathbb{k}) \otimes (\pi_*(X) \otimes \mathbb{k}) \rightarrow \pi_*(X) \otimes \mathbb{k}.$$

The first assertion is due (essentially) to Hopf and the last two to Cartan-Serre-Milnor-Moore.

This section is organized into the following topics:

- (a) The loop space homology algebra.
- (b) The minimal Sullivan model of the path space fibration.
- (c) The rational product decomposition of ΩX .
- (d) The primitive subspace of $H_*(\Omega X; \mathbb{k})$.
- (e) Whitehead products, commutators and the algebra structure of $H_*(\Omega X; \mathbb{k})$.

(a) The loop space homology algebra.

Let (Y, y_0) be a based path connected space. Recall (§3(b)) that the tensor product of graded algebras A and B is the graded algebra $A \otimes B$ with $(a \otimes b)(a_1 \otimes b_1) = (-1)^{\deg b \deg a_1} a a_1 \otimes b b_1$. Recall also (§3 (e)) that since \mathbb{k} is a field, homology commutes with tensor products.

Lemma 16.2

- (i) If $f : (X, x_0) \rightarrow (Y, y_0)$ is continuous then $H_*(\Omega f; \mathbb{k})$ is a morphism of graded algebras.
- (ii) $H(EZ) : H_*(\Omega X; \mathbb{k}) \otimes H_*(\Omega Y; \mathbb{k}) \xrightarrow{\cong} H_*(\Omega X \times \Omega Y; \mathbb{k})$ is an isomorphism of graded algebras.

proof: The first assertion follows from the naturality of EZ and the fact that Ωf is a morphism of topological monoids. The second assertion is a trivial consequence of formula (4.8) in §4(b). \square

Next, recall from §4(b) that the topological diagonal $\Delta_{\text{top}} : Y \rightarrow Y \times Y$, $y \mapsto (y, y)$, induces the Alexander-Whitney diagonal

$$\Delta = AW \circ C_*(\Delta_{\text{top}}) : C_*(Y; \mathbb{k}) \rightarrow C_*(Y; \mathbb{k}) \otimes C_*(Y; \mathbb{k}).$$

Since homology commutes with tensor products, $H_*(\Delta; \mathbb{k})$ is a linear map

$$H_*(\Delta; \mathbb{k}) : H_*(Y; \mathbb{k}) \rightarrow H_*(Y; \mathbb{k}) \otimes H_*(Y; \mathbb{k}).$$

For simplicity we abbreviate $H_*(\Delta; \mathbb{k})$ to $H(\Delta)$.

In §4(b) we observed that $(C_*(Y; \mathbb{k}), \Delta)$ is a differential graded coalgebra, co-augmented by any $y \in Y$. Passing to homology, we see that $H(\Delta)$ makes $H_*(Y; \mathbb{k})$ into a graded coalgebra, co-augmented by any $[y] \in H_0(Y; \mathbb{k})$. If Y is

path connected these homology classes all coincide and we denote them by 1. In this case we have for all $\alpha \in H_+(Y; \mathbb{k})$ that

$$H(\Delta)\alpha - (\alpha \otimes 1 + 1 \otimes \alpha) \in H_+(Y; \mathbb{k}) \otimes H_+(Y; \mathbb{k}) ,$$

as observed in §3(d). In particular, the element α is primitive if

$$H(\Delta)\alpha = \alpha \otimes 1 + 1 \otimes \alpha$$

and the primitive elements form a graded subspace $P_*(Y; \mathbb{k}) \subset H_+(Y; \mathbb{k})$, the primitive subspace of $H_*(Y; \mathbb{k})$.

Remark Note that the product (§5) in the cohomology algebra $H^*(Y; \mathbb{k})$ is dual to the comultiplication $H(\Delta)$.

Lemma 16.3 *If $Y = \Omega X$ then $H(\Delta) : H_*(\Omega X; \mathbb{k}) \rightarrow H_*(\Omega X; \mathbb{k}) \otimes H_*(\Omega X; \mathbb{k})$ is a morphism of graded algebras.*

proof: Observe that $\Omega X \times \Omega X$ is a topological monoid with component-wise multiplication, and that Δ_{top} is a morphism of topological monoids. It follows that $H_*(\Delta_{\text{top}}) : H_*(\Omega X; \mathbb{k}) \rightarrow H_*(\Omega X \times \Omega X; \mathbb{k})$ is a morphism of graded algebras. On the other hand $H(AW) = H(EZ)^{-1}$ as shown in Proposition 4.10. Since $H(EZ)$ is a morphism of graded algebras (Lemma 16.2) so is $H(AW)$. Hence so is $H(\Delta)$. □

Example 1 *The homology algebra $H_*(\Omega S^{2k+1}; \mathbb{k})$, $k \geq 1$.*

Let $f : S^{2k} \rightarrow \Omega S^{2k+1}$ satisfy $[f] = \partial_*[id_{S^{2k+1}}]$. Then the Hurewicz theorem 4.19 asserts that $H_*(f)[S^{2k}]$ is a non-zero homology class $\alpha \in H_{2k}(\Omega S^{2k+1}; \mathbb{k})$. The inclusion of α extends to a unique morphism from the polynomial algebra $\mathbb{k}[\alpha]$. We show this is an isomorphism:

$$\mathbb{k}[\alpha] \xrightarrow{\cong} H_*(\Omega S^{2k+1}; \mathbb{k}).$$

In fact $[S^{2k}]$ is (trivially) primitive in $H_*(S^{2k}; \mathbb{k})$ and so α is primitive in $H_*(\Omega S^{2k+1}; \mathbb{k})$. Since $H(\Delta)$ is an algebra morphism, and since k is even,

$$H(\Delta)\alpha^n = (\alpha \otimes 1 + 1 \otimes \alpha)^n = \alpha^n \otimes 1 + n\alpha^{n-1} \otimes \alpha + \cdots + 1 \otimes \alpha^n, \quad n \geq 1.$$

If $\alpha^{n-1} \neq 0$ then it follows that $H(\Delta)\alpha^n \neq 0$ and so $\alpha^n \neq 0$. Hence our morphism is injective. But in Example 1, §15(b) we computed the Hilbert series of $H^*(\Omega S^{2k+1}; \mathbb{k})$ to be $(1 - z^{2k})^{-1}$. Thus

$$\dim H_i(\Omega S^{2k+1}; \mathbb{k}) = \dim H^i(\Omega S^{2k+1}; \mathbb{k}) = \begin{cases} 1 & , i = 2rk \\ 0 & , \text{otherwise} \end{cases} = \dim \mathbb{k}[\alpha]_i.$$

It follows that the morphism above is an isomorphism. At the end of §16(d) we establish the same result for $H_*(\Omega S^{2k}; \mathbb{k})$. □

(b) The minimal Sullivan model of the path space fibration .

Suppose (X, x_0) is a based topological space satisfying (16.1) and let $m_X : (\Lambda V_X, d) \rightarrow A_{PL}(X)$ be a minimal Sullivan model for X . Then the path space, PX , has a Sullivan model of the form

$$m : (\Lambda V_X \otimes \Lambda V, d) \xrightarrow{\cong} A_{PL}(PX).$$

It factors to give a minimal Sullivan model $\bar{m} : (\Lambda V, \bar{d}) \rightarrow A_{PL}(\Omega X)$ for the loop space ΩX (the Corollary to Proposition 15.5 applied to the path space fibration $PX \rightarrow X$). As in §15(e) recall that the linear part of d is the differential d_0 in $V_X \oplus V$ defined by requiring $(d - d_0)x \in \Lambda^{\geq 2}(V_X \oplus V)$. Because of the minimality of $(\Lambda V_X, d)$ and $(\Lambda V, d)$ we have $d_0 = 0$ in V_X and $d_0 : V \rightarrow V_X$.

Now observe that

$$d_0 : V \xrightarrow{\cong} V_X.$$

Indeed, $(\Lambda V_X \otimes \Lambda V, d)$ is the tensor product of a contractible algebra and a minimal model for PX (Theorem 14.9). Because PX is contractible the minimal model is trivial and $(\Lambda V_X \otimes \Lambda V, d)$ itself is contractible. This implies $H(V_X \oplus V, d_0) = 0$ and hence that $d_0 : V \xrightarrow{\cong} V_X$.

Next, recall that V_X is a graded vector space of finite type (Proposition 12.2). Hence so is $H^*(\Omega X; \mathbb{k}) \cong H(\Lambda V, \bar{d})$. Since ΩX is an H -space it follows (Example 3, §12(a)) that *the differential \bar{d} is zero*,

$$\bar{m} : (\Lambda V, 0) \xrightarrow{\cong} A_{PL}(\Omega X).$$

Thus $d : \Lambda(V_X \oplus V) \rightarrow \Lambda^+ V_X \otimes \Lambda V$. In particular, $H^*(\Omega X; \mathbb{k})$ is the free graded commutative algebra ΛV .

Moreover, if $2k_1, 2k_2, \dots$ and $2\ell_1 + 1, 2\ell_2 + 1, \dots$ are the degrees of a basis of V then the Hilbert series for $H^*(\Omega X; \mathbb{k})$ has the form

$$H^*(\Omega X; \mathbb{k})(z) = \frac{\prod_i (1 + z^{2\ell_i + 1})}{\prod_j (1 - z^{2k_j})}. \tag{16.4}$$

Next observe that the action of ΩX on PX is a map of fibrations,

$$\begin{array}{ccc} PX \times \Omega X & \xrightarrow{g} & PX \\ \downarrow p \circ p^L & & \downarrow p \\ X & \xrightarrow{id_X} & X \end{array}$$

where p^L denotes projection on the left factor, PX . The tensor product of Sullivan models is a Sullivan model for the topological product (Example 2, §12(a)) and so

$$m \cdot \bar{m} : (\Lambda V_X \otimes \Lambda V, d) \otimes (\Lambda V, 0) \xrightarrow{\cong} A_{PL}(PX \times \Omega X)$$

is a Sullivan model.

The restriction of g to the fibres at x_0 is the multiplication $\mu : \Omega X \times \Omega X \rightarrow \Omega X$. Thus the construction of diagram (15.9) gives a commutative diagram

$$\begin{array}{ccccc}
 (\Lambda V_X, d) & \longrightarrow & (\Lambda V_X \otimes \Lambda V, d) & \longrightarrow & (\Lambda V, 0) \\
 \downarrow id & & \downarrow \varphi & & \downarrow \bar{\varphi} \\
 (\Lambda V_X, d) & \longrightarrow & (\Lambda V_X \otimes \Lambda V, d) \otimes (\Lambda V, 0) & \longrightarrow & (\Lambda V, 0) \otimes (\Lambda V, 0)
 \end{array}$$

in which $\bar{\varphi}$ is a Sullivan representative for μ . In particular, $(\bar{m} \cdot \bar{m})\bar{\varphi} \sim A_{PL}(\mu)\bar{m}$, and so $H(\bar{m}) : \Lambda V \xrightarrow{\cong} H^*(\Omega X; \mathbb{k})$ identifies $\bar{\varphi}$ with the dual of the multiplication map for the graded algebra $H_*(\Omega X; \mathbb{k})$. The fact that $1 \in H_0(\Omega X; \mathbb{k})$ is the identity element translates to

$$\bar{\varphi}\Phi - (\Phi \otimes 1 + 1 \otimes \Phi) \in \Lambda^+ V \otimes \Lambda^+ V, \quad \Phi \in \Lambda^+ V. \tag{16.5}$$

Recall next (§13(e)) that the *quadratic part* of the differential d in ΛV_X is the derivation d_1 determined by the two conditions

$$d_1 : V_X \rightarrow \Lambda^2 V_X \quad \text{and} \quad d - d_1 : V_X \rightarrow \Lambda^{\geq 3} V_X.$$

In §13(e) we showed how to compute d_1 from Whitehead products. Here we show how to compute d_1 using the map $\bar{\varphi}$.

Let $v \in V$ and, as in (16.5) above, write

$$\bar{\varphi}v = v \otimes 1 + \sum \Phi_i \otimes \Psi_i + 1 \otimes v,$$

with $\Phi_i, \Psi_i \in \Lambda^+ V$. Recall that $\zeta : \Lambda^+ V \rightarrow V$ is the projection corresponding to the decomposition $\Lambda^+ V = V \oplus \Lambda^{\geq 2} V$ and that $d_0 : V \xrightarrow{\cong} V_X$.

Proposition 16.6 *The quadratic part of the differential in ΛV_X is given by*

$$d_1 d_0 v = \sum_i (-1)^{\deg \Phi_i} (d_0 \zeta \Phi_i) \wedge (d_0 \zeta \Psi_i).$$

proof: Write $dv = d_0 v + \sum_i u_i \otimes v_i + \Phi + \Omega$ with $u_i \in V_X, v_i \in V, \Phi \in \Lambda^2 V_X$, and $\Omega \in \Lambda^{\geq 3}(V_X \oplus V)$. Since $d^2 v = 0$ the component of $d^2 v$ in $\Lambda^2(V_X \oplus V)$ is zero, and this fact translates to

$$d_1 d_0 v = - \sum_i (-1)^{\deg u_i} u_i \wedge d_0 v_i.$$

On the other hand, since $\varphi dv = (d \otimes id)\varphi v$, the components of φdv and $(d \otimes id)\varphi v$ in $V_X \otimes 1 \otimes V$ also coincide. Use the following facts to compute these components:

- $\text{Im } d \subset \Lambda^+ V_X \otimes \Lambda V$ • $\text{Im}(\varphi - id \otimes \bar{\varphi}) \subset \Lambda^+ V_X \otimes \Lambda V \otimes \Lambda V$
- $\varphi = id$ in ΛV_X • $\bar{\varphi}v_i - 1 \otimes v_i \in \Lambda^+ V \otimes \Lambda V$.

This gives the equation $\sum u_i \otimes 1 \otimes v_i = \sum d_0 \zeta \Phi_i \otimes 1 \otimes \zeta \Psi_i$, whence $\sum_i (-1)^{\deg u_i} u_i \wedge d_0 v_i = - \sum_i (-1)^{\deg \Phi_i} (d_0 \zeta \Phi_i) \wedge (d_0 \zeta \Psi_i)$. \square

(c) The rational product decomposition of ΩX .

We turn the first part of the algebra above into geometry and provide a geometric proof of (16.4) by identifying ΩX as (rationally) a product of odd spheres and loop spaces of odd spheres.

First we need to make some remarks about infinite products. Suppose $(X_\alpha, *)_{\alpha \in \mathcal{J}}$ is a family of based topological spaces. Let $X(\alpha_1, \dots, \alpha_r) \subset \prod_{\alpha} X_\alpha$ be the subspace of points (x_α) such that $x_\alpha = *$ if $\alpha \neq \alpha_1, \dots, \alpha_r$; clearly $X(\alpha_1, \dots, \alpha_r) \cong X_{\alpha_1} \times \dots \times X_{\alpha_r}$. Let $\tilde{\prod}_{\alpha} X_\alpha$ be the union of the $X(\alpha_1, \dots, \alpha_r)$ as $\{\alpha_1, \dots, \alpha_r\}$ ranges over all finite subsets of \mathcal{J} and give it the weak topology determined by the $X(\alpha_1, \dots, \alpha_r)$. This space is called the *weak product* of the $(X_\alpha, *)$.

Any compact subspace of $\tilde{\prod}_{\alpha} X_\alpha$ is contained in some $X(\alpha_1, \dots, \alpha_r)$, so $\tilde{\prod}_{\alpha} X_\alpha$ is indeed a k -space. Moreover, if each X_α is a CW complex with $*$ $\in (X_\alpha)_0$ then so is each $X(\alpha_1, \dots, \alpha_r)$, and this makes $\tilde{\prod}_{\alpha} X_\alpha$ into a based CW complex.

It also follows that

$$\pi_* \left(\tilde{\prod}_{\alpha} X_\alpha \right) = \bigotimes_{\alpha} \pi_*(X_\alpha)$$

and so if each X_α is an Eilenberg-MacLane space $K(V_\alpha; n)$ then $\tilde{\prod}_{\alpha} X_\alpha$ is a $K(\bigoplus_{\alpha} V_\alpha, n)$. Finally, given a topological monoid G with unit element e and continuous based maps $f_\alpha : (X_\alpha, *) \rightarrow (G, e)$ we define

$$(f_\alpha) : \tilde{\prod}_{\alpha} X_\alpha \rightarrow G, \quad (f_\alpha)(x_\alpha) = \prod_{\alpha} f_\alpha(x_\alpha) .$$

Now we return to the study of ΩX . First, suppose $(X, *)$ is an arbitrary simply connected based topological space. Every based map $a : S^{k+1} \rightarrow X$ determines two maps: $\Omega a : \Omega S^{k+1} \rightarrow \Omega X$ and $\bar{a} : S^k \rightarrow \Omega X$, where $[\bar{a}] = \partial_*[a]$ is the image of $[a]$ in $\pi_*(\Omega X)$ under the connecting homomorphism for the path space fibration. Moreover, if $id : S^{k+1} \rightarrow S^{k+1}$ is the identity then $\bar{a} \sim \Omega a \circ \overline{id}$ by the naturality of ∂_* . Let $b_i : S^{2\ell_i+2} \rightarrow X$ and $a_j : S^{2k_j+1} \rightarrow X$ represent a basis of $\pi_*(X) \otimes \mathbb{Q}$. Multiplication of the \bar{b}_i and the Ωa_j defines a continuous map

$$f = (\bar{b}_i) \cdot (\Omega a_j) : \tilde{\prod}_i S^{2\ell_i+1} \times \tilde{\prod}_j \Omega S^{2k_j+1} \rightarrow \Omega X.$$

Proposition 16.7 *Both $\pi_*(f) \otimes \mathbb{k}$ and $H_*(f; \mathbb{k})$ are isomorphisms.*

proof: Since \mathbb{k} is a field of characteristic zero it is sufficient to prove this for $\mathbb{k} = \mathbb{Q}$. Recall (Example 1, §15(d)) that $\pi_*(S^{2n+1}) \otimes \mathbb{Q} = \mathbb{Q} \cdot [id_{S^{2n+1}}]$. It is immediate from this and the construction that $\pi_*(f) \otimes \mathbb{Q}$ is an isomorphism. If ΩX is simply connected the Whitehead-Serre theorem 8.6 asserts that $H_*(f; \mathbb{Q})$ is an isomorphism. To prove this when ΩX is connected we may replace X by any other space with the same weak homotopy type.

Let K be an Eilenberg-MacLane space of type $(\pi_2(X), 2)$, and choose a cellular model X' for X (§1(a)). Choose a map $\sigma : X' \rightarrow K$ such that $\pi_2(\sigma) = \text{identity}$ (Proposition 4.20) and convert σ to a fibration (§2(c)). In this way we reduce to the case that there is a fibration $q : X \rightarrow K$ whose fibre, F , is 2-connected.

Write the infinite product above as $\left(\prod_i S_i^1\right) \times Z$, where Z is the weak product of the odd spheres of higher dimension and the loop spaces ΩS^{2k_j+1} . Then we may construct f so that it restricts to $f_1 : Z \rightarrow \Omega F$ with $\pi_*(f_1) \otimes \mathbb{Q}$ also an isomorphism. By the Whitehead-Serre Theorem 8.6, $H_*(f_1; \mathbb{Q})$ is an isomorphism.

On the other hand, $\Omega q : \Omega X \rightarrow \Omega K$ is an ΩF -fibration (§2(b)). Let f_2 be the restriction of f to $\prod_i S_i^1$ and put $g = (\Omega q)f_2 : \prod_i S_i^1 \rightarrow \Omega K$. Then define a map of ΩF -fibrations

$$\begin{array}{ccc} \prod_i S_i^1 \times \Omega F & \xrightarrow{h} & \Omega X \\ \text{proj} \downarrow & & \downarrow \Omega q \\ \prod_i S_i^1 & \xrightarrow{g} & \Omega K \end{array}$$

by setting $h(x, y) = f(x) \cdot y$. Since $h \circ (id \times f_1) = f$, it is sufficient to prove that $H_*(h; \mathbb{Q})$ is an isomorphism. This will follow from Theorem 8.5 if $H_*(g; \mathbb{Q})$ is an isomorphism. But we can write $\prod_i S_i^1 = K \left(\bigoplus_i \mathbb{Z}, 1\right) = \Omega K \left(\bigoplus_i \mathbb{Z}, 2\right)$. Hence $g \sim \Omega g_1$, where $\pi_2(g_1) = \pi_1(g)$. In particular, $\pi_2(g_1) \otimes \mathbb{Q}$ is an isomorphism, and so the Whitehead-Serre theorem asserts that $H_*(\Omega g_1; \mathbb{Q})$ is an isomorphism too. □

In summary: *the map f is a rational homotopy equivalence.* Thus loop spaces have the rational homotopy type of a weak product of odd spheres and loop spaces on odd spheres. Moreover Proposition 10.7 has the following

Corollary *Let X be any simply connected topological space. Then there is a rational homotopy equivalence of the form*

$$\prod_{n \geq 1} K_n \rightarrow \Omega X$$

where $\pi_*(K_n) \otimes \mathbb{Q}$ is concentrated in degree n . □

We now suppose that $H_*(X; \mathbb{Q})$ has finite type. Then (Remark 1 following Theorem 15.11) $\pi_*(X) \otimes \mathbb{Q}$ has finite type and there are finitely many odd spheres (or loop spaces on odd spheres) of any given dimension in the weak product of Proposition 16.7. Thus a simple modification of the argument for finite products (Example 2, §12(a)) shows that the minimal Sullivan model for ΩX is the tensor product of the minimal Sullivan models for the $S^{2\ell_i+1}$ and the ΩS^{2k_j+1} . In particular the form of a minimal Sullivan model for ΩX and formula (16.4) could equally well have been deduced from Proposition 16.7.

Next, define homology classes β_i and α_j in $H_*(\Omega X; \mathbb{k})$ by setting

$$\beta_i = H_*(\bar{b}_i)[S^{2\ell_i+1}] \quad \text{and} \quad \alpha_j = H_*(\bar{a}_j)[S^{2k_j}].$$

A homology class in $H_*(\Omega X; \mathbb{k})$ is called *distinguished* if it can be written in the form

$$\begin{aligned} \gamma = \beta_{i_1} \cdots \beta_{i_p} \cdot \alpha_{j_1}^{n_1} \cdots \alpha_{j_q}^{n_q}, \quad & i_1 < \cdots < i_p, \\ & j_1 < \cdots < j_q, \\ & n_1, \dots, n_q \in \mathbb{N}, \end{aligned}$$

with $p, q \geq 0$. (If $p = 0$ there are no β_i 's in the expression, and if $q = 0$ there are no α_j 's. When $p = q = 0$ there is a single class $\gamma = 1$.)

Proposition 16.8 *The distinguished homology classes $\beta_{i_1} \cdots \beta_{i_p} \cdot \alpha_{j_1}^{n_1} \cdots \alpha_{j_q}^{n_q}$ are a basis of the graded vector space $H_*(\Omega X; \mathbb{k})$.*

proof: Recall that $\bar{a}_j \sim (\Omega \alpha_j) \bar{id}$, where $\bar{id} : S^{2k_j} \rightarrow \Omega S^{2k_j+1}$ represents $\partial_*[id_{S^{2k_j+1}}]$. Denote $H_*(\bar{id})[S^{2k_j}]$ simply by $[S_j] \in H_*(\Omega S^{2k_j+1}; \mathbb{k})$. The classes $1, [S_j], [S_j]^2, \dots$ are a basis for $H_*(\Omega S^{2k_j+1}; \mathbb{k})$, as we showed in the Example at the start of §16. Denote $[S^{2\ell_i+1}]$ simply by $[S_i]$, so that 1 and $[S_i]$ are a basis for $H_*(S^{2\ell_i+1}; \mathbb{k})$. Then (Eilenberg-Zilber) the classes

$$[S_{i_1}] \otimes \cdots \otimes [S_{i_p}] \otimes [S_{j_1}]^{n_1} \otimes \cdots \otimes [S_{j_q}]^{n_q}$$

are a basis for $H_* \left(\prod_i S^{2\ell_i+1} \times \prod_j \Omega S^{2k_j+1}; \mathbb{k} \right)$. This basis is mapped by $H_*(f)$ onto the set of distinguished homology classes in $H_*(\Omega X; \mathbb{k})$. □

(d) The primitive subspace of $H_*(\Omega X; \mathbb{k})$.

Again suppose X is simply connected with rational homology of finite type. Recall from §16(a) that $H(\bar{m}) : \Lambda V \xrightarrow{\cong} H^*(\Omega X; \mathbb{k})$, and that if $[z], [w] \in H^*(\Omega X; \mathbb{k})$ and $\alpha \in H_+(\Omega X; \mathbb{k})$ then

$$\langle [z] \cup [w], \alpha \rangle = \langle [z] \otimes [w], H(\Delta)\alpha \rangle.$$

Thus α is primitive if and only if $\langle [z] \cup [w], \alpha \rangle = 0$ for all $[z], [w] \in H^+(\Omega X; \mathbb{k})$, i.e., if and only if $\langle H(\bar{m})(\Lambda^{\geq 2} V), \alpha \rangle = 0$. There follows

Lemma 16.9 *A non-degenerate pairing between V and $P_*(\Omega X; \mathbb{k})$ is given by*

$$(v, \alpha) \longmapsto \langle H(\bar{m})v, \alpha \rangle. \quad \square$$

Next note that if $f : Y \rightarrow Z$ is a continuous map between path connected topological spaces, then $H_*(f)$ restricts to a map $P_*(Y; \mathbb{k}) \rightarrow P_*(Z; \mathbb{k})$, because the Alexander-Whitney diagonal is natural. Moreover, $[S^k] \in H_k(S^k; \mathbb{k})$ is primitive because $H_i(S^k; \mathbb{k}) = 0$, $1 \leq i \leq k - 1$. Hence if $a : S^k \rightarrow Y$ then $hur_Y([a]) = H_*(a)[S^k]$ is a primitive element in $H_*(Y; \mathbb{k})$. Thus we may regard the Hurewicz homomorphism as a linear map

$$\pi_*(Y) \rightarrow P_*(Y; \mathbb{k}).$$

Recall that the topological space X we are considering is simply connected and has homology of finite type (hypothesis (16.1)).

Theorem 16.10 (Cartan-Serre) *The Hurewicz homomorphism extends to an isomorphism*

$$\pi_*(\Omega X) \otimes \mathbb{k} \xrightarrow{\cong} P_*(\Omega X; \mathbb{k}).$$

proof: We begin with three simple observations.

(i) $hur : \pi_*(S^{2\ell+1}) \otimes \mathbb{k} \xrightarrow{\cong} P_*(S^{2\ell+1}; \mathbb{k}), \ell \geq 0.$

Indeed, the Hurewicz theorem 4.19 asserts this is an isomorphism in degrees $\leq 2\ell + 1$. The homology of $S^{2\ell+1}$ vanishes in higher degrees (4.14) as does $\pi_*(S^{2\ell+1}) \otimes \mathbb{k}$ (Example 1, §15(d)).

(ii) $hur : \pi_*(\Omega S^{2k+1}) \otimes \mathbb{k} \xrightarrow{\cong} P_*(\Omega S^{2k+1}; \mathbb{k}), k \geq 1.$

Since $\pi_*(\Omega S^{2k+1}) \otimes \mathbb{k} \cong \pi_{*+1}(S^{2k+1}) \otimes \mathbb{k}$ we conclude, as in (i) that this graded vector space is concentrated in degree $2k$. Thus the Hurewicz Theorem 4.19 asserts that $hur : \pi_*(\Omega S^{2k+1}) \otimes \mathbb{k} \xrightarrow{\cong} P_{2k}(\Omega S^{2k+1}; \mathbb{k})$. In the Example at the start of §16 we saw that $H_*(\Omega S^{2k+1}; \mathbb{k}) = \mathbb{k}[\alpha]$ with $\deg \alpha = 2k$, and that $H(\Delta)\alpha^n = \sum_{i=0}^n \binom{n}{i} \alpha^i \otimes \alpha^{n-i}$. This shows that α^n is not primitive for $n \geq 2$, so that $P_*(\Omega S^{2k+1}; \mathbb{k}) = P_{2k}(\Omega S^{2k+1}; \mathbb{k})$.

(iii) *If Y and Z are path connected topological spaces, then*

$$\pi_*(Y \times Z) = \pi_*(Y) \oplus \pi_*(Z) \quad \text{and} \quad P_*(Y \times Z; \mathbb{k}) = P_*(Y; \mathbb{k}) \oplus P_*(Z; \mathbb{k}).$$

The first assertion is immediate from the definition of π_* . For the second, recall that Eilenberg-Zilber induces an isomorphism $H_*(Y; \mathbb{k}) \otimes H_*(Z; \mathbb{k}) \xrightarrow{\cong} H_*(Y \times$

$Z; \mathbb{k}$). It follows easily from formula (4.9), §4(b) that this is an isomorphism of graded coalgebras.

Let $\varepsilon : H_*(-; \mathbb{k}) \rightarrow \mathbb{k}$ be the augmentation induced by the constant map to a point. Thus

$$(id \cdot \varepsilon_Z) \otimes (\varepsilon_Y \cdot id) : [H_*(Y; \mathbb{k}) \otimes H_*(Z; \mathbb{k})] \otimes [H_*(Y; \mathbb{k}) \otimes H_*(Z; \mathbb{k})] \\ \rightarrow H_*(Y; \mathbb{k}) \otimes H_*(Z; \mathbb{k}).$$

But if $\gamma \in H_*(Y; \mathbb{k}) \otimes H_*(Z; \mathbb{k})$ and if Δ_{\otimes} denotes the comultiplication in the tensor product coalgebra then clearly

$$(id \cdot \varepsilon_Z) \otimes (\varepsilon_Y \cdot id) \circ \Delta_{\otimes}(\gamma) = \gamma.$$

Hence if γ is primitive then $\gamma \in (H_+(Y; \mathbb{k}) \otimes 1) \oplus (1 \otimes H_+(Z; \mathbb{k}))$ and so $\gamma \in P_*(Y; \mathbb{k}) \oplus P_*(Z; \mathbb{k})$.

Now recall the continuous map

$$f : \prod_i \tilde{S}^{2\ell_i+1} \times \prod_j \tilde{\Omega}S^{2k_j+1} \rightarrow \Omega X$$

of Proposition 16.7 and denote this, for simplicity, by $f : Y \rightarrow \Omega X$. The three observations above imply that

$$hur : \pi_*(Y) \otimes \mathbb{k} \xrightarrow{\cong} P_*(Y; \mathbb{k}).$$

Since $\pi_*(f) \otimes \mathbb{k}$ is an isomorphism and since the isomorphism $H_*(f; \mathbb{k})$ necessarily restricts to an isomorphism $P_*(Y; \mathbb{k}) \xrightarrow{\cong} P_*(\Omega X; \mathbb{k})$, the theorem follows. \square

(e) Whitehead products, commutators, and the algebra structure of $H_*(\Omega X; \mathbb{k})$.

Again suppose X is simply connected with rational homology of finite type.

The *commutator* of two elements σ and τ in a graded algebra is the element $[\sigma, \tau]$ defined by

$$[\sigma, \tau] = \sigma\tau - (-1)^{\deg \sigma \deg \tau} \tau\sigma.$$

Recall (§16(c)) that as a graded vector space, $H_*(\Omega X; \mathbb{k})$ has a distinguished basis consisting of the elements of the form

$$\beta_{i_1} \cdots \beta_{i_p} \cdot \alpha_{j_1}^{n_1} \cdots \alpha_{j_q}^{n_q}, \quad \begin{array}{l} i_1 < \cdots < i_p, \\ j_1 < \cdots < j_q, \\ n_1, \dots, n_q \in \mathbb{N}. \end{array}$$

Thus the algebra structure of $H_*(\Omega X; \mathbb{k})$ would be completely determined if we knew the commutators

$$[\beta_i, \beta_{i'}], [\beta_i, \alpha_j] \quad \text{and} \quad [\alpha_j, \alpha_{j'}].$$

(Since $\deg \beta_i$ is odd, $\beta_i^2 = \frac{1}{2}[\beta_i, \beta_i]$.)

We shall express these simply and explicitly in terms of Whitehead products (§13(e)), using the linear map $\theta = \text{hur} \circ \partial_* : \pi_*(X) \rightarrow H_{*-1}(\Omega X; \mathbb{k})$.

Proposition 16.11 *If $\gamma_0 \in \pi_{k+1}(X)$ and $\gamma_1 \in \pi_{n+1}(X)$ then*

$$[\theta\gamma_0, \theta\gamma_1] = (-1)^{k+1} \theta([\gamma_0, \gamma_1]_W) .$$

proof: In Proposition 16.6 we showed that the quadratic part of the differential in ΛV_X was given by

$$d_1 d_0 v = \sum_i (-1)^{\deg \Phi_i} (d_0 \zeta \Phi_i) \wedge (d_0 \zeta \Psi_i), \quad v \in V,$$

where $\bar{\varphi}v = v \otimes 1 + \sum \Phi_i \otimes \Psi_i + 1 \otimes v$. Since $d_0 \zeta$ is dual to θ (Proposition 15.14) and since $\bar{\varphi}$ is dual to the multiplication in $H_*(\Omega X; \mathbb{k})$, we have

$$\begin{aligned} \langle H(\bar{m})v, [\theta\gamma_0, \theta\gamma_1] \rangle &= \langle H(\bar{m})v, (\theta\gamma_0)(\theta\gamma_1) - (-1)^{kn}(\theta\gamma_1)(\theta\gamma_0) \rangle \\ &= \langle \sum H(\bar{m})\Phi_i \otimes H(\bar{m})\Psi_i, \theta\gamma_0 \otimes \theta\gamma_1 - (-1)^{kn}\theta\gamma_1 \otimes \theta\gamma_0 \rangle \\ &= \sum_i (-1)^{k \deg \Psi_i} \langle H(\bar{m})\Phi_i, \theta\gamma_0 \rangle \langle H(\bar{m})\Psi_i, \theta\gamma_1 \rangle \\ &\quad - \sum_i (-1)^{kn+n \deg \Psi_i} \langle H(\bar{m})\Phi_i, \theta\gamma_1 \rangle \langle H(\bar{m})\Psi_i, \theta\gamma_0 \rangle \\ &= \sum_i (-1)^{kn+k+n} \langle d_0 \zeta \Phi_i; \gamma_0 \rangle \langle d_0 \zeta \Psi_i; \gamma_1 \rangle \\ &\quad + \sum_i (-1)^{k+n+1} \langle d_0 \zeta \Phi_i; \gamma_1 \rangle \langle d_0 \zeta \Psi_i; \gamma_0 \rangle \\ &= (-1)^{k+1} \langle \sum_i (-1)^{\deg \Phi_i} (d_0 \zeta \Phi_i) \wedge (d_0 \zeta \Psi_i); \gamma_0, \gamma_1 \rangle. \end{aligned}$$

On the other hand, we may apply Proposition 13.16 where we calculated the Whitehead product to obtain

$$\begin{aligned} \langle H(\bar{m})v; \theta[\gamma_0, \gamma_1]_W \rangle &= (-1)^{k+n+1} \langle d_0 v; [\gamma_0, \gamma_1]_W \rangle \\ &= \langle d_1 d_0 v; \gamma_0, \gamma_1 \rangle. \end{aligned}$$

The Proposition follows from these formulae, given the duality between V and $P_*(\Omega X; \mathbb{k})$ established in Lemma 16.9. □

Finally, suppose given $\pi_*(X) \otimes \mathbb{k}$ together with the Whitehead products. Define a graded vector space L_X by setting $(L_X)_k = \pi_{k+1}(X) \otimes \mathbb{k}$ and denote by

$sx \in \pi_*(X) \otimes \mathbb{k}$ the element corresponding to $x \in L_X$. In the tensor algebra TL_X let I be the (two sided) ideal generated by elements of the form

$$x \otimes y - (-1)^{\deg x \deg y} y \otimes x - (-1)^{\deg sx} s^{-1} ([sx, sy]_W). \tag{16.12}$$

Theorem 16.13 *The Hurewicz homomorphism extends uniquely to an isomorphism of graded algebras*

$$(TL_X)/I \xrightarrow{\cong} H_*(\Omega X; \mathbb{k}).$$

proof: First observe that an identification $L_X = \pi_*(\Omega X) \otimes \mathbb{k}$ is specified by identifying x with $\partial_* sx$, $x \in L_X$. This identifies $hur_{\Omega X}$ as a linear map $L_X \rightarrow H_*(\Omega X; \mathbb{k})$, which then automatically extends to a morphism $TL_X \rightarrow H_*(\Omega X; \mathbb{k})$ of graded algebras. Proposition 16.11 asserts precisely that the elements (16.12) are in the kernel of this morphism. Hence it factors over the quotient $TL_X \rightarrow (TL_X)/I$ to define a morphism of graded algebras

$$\sigma : (TL_X)/I \rightarrow H_*(\Omega X; \mathbb{k}).$$

We have to show that σ is an isomorphism.

As in §16(b) let $b_i : S^{2\ell_i+2} \rightarrow X$ and $a_j : S^{2k_j+1} \rightarrow X$ represent a basis of $\pi_*(X) \otimes \mathbb{k}$. Put $y_i = s^{-1}[b_i]$ and $x_j = s^{-1}[a_j]$. Thus $\{y_i, x_j\}$ is a basis of L_X .

Recall that $T^s L_X = L_X \otimes \cdots \otimes L_X$ (s factors). Let $F_s \subset (TL_X)/I$ be the image of $T^{\leq s} L_X$; elements in F_s have *filtration degree* s . By the very definition of I , if $z, w \in L_X$ then $zw - (-1)^{\deg z \deg w} wz$ has filtration length 1. In particular if z has odd degree then $z^2 = \frac{1}{2}(zz + zz)$ has filtration degree 1.

An obvious induction on filtration degree now shows that every element in $(TL_X)/I$ is a linear combination of the elements

$$y_{i_1} \cdots y_{i_p} \cdot x_{j_1}^{n_1} \cdots x_{j_q}^{n_q}, \quad \begin{array}{l} i_1 < \cdots < i_p \\ j_1 < \cdots < j_q \\ n_i \in \mathbb{N}. \end{array}$$

(Show that the subset with $p + \sum n_\ell \leq s$ spans F^s .) The morphism σ maps these elements to the distinguished basis of $H_*(\Omega X; \mathbb{k})$ established in Proposition 16.8. Hence the elements above must be a basis of $(TL_X)/I$ and σ must be an isomorphism. □

Example 1 *The homology algebra $H_*(\Omega S^{n+1}; \mathbb{k})$.*

Let $a : S^n \rightarrow \Omega S^{n+1}$ represent $\partial_*[id_{S^{n+1}}]$, and let $\alpha = hur[a] = H_*(a)[S^n] \in H_n(\Omega S^n; \mathbb{k})$. We show that the inclusion of α extends to an isomorphism

$$\mathbb{k}[\alpha] \xrightarrow{\cong} H_*(\Omega S^{n+1}; \mathbb{k})$$

of graded algebras. If n is odd this has already been done in the example at the start of §16.

Suppose $n = 2k$. Let $\iota = [id_{S^{2n}}] \in \pi_{2k}(S^{2k})$. Then $\pi_*(S^{2k}) \otimes \mathbb{k}$ is two dimensional, with basis given by ι and $[\iota, \iota]_W$ (Example 1, §15(d)). Apply Theorem 16.13 to obtain an isomorphism

$$T(x, y) / (x^2 - \frac{1}{2}y) \xrightarrow{\cong} H_*(\Omega S^{2k}; \mathbb{k}).$$

Then note that $T(x, y) / (x^2 - \frac{1}{2}y) = T(x) = \mathbb{k}[x]$, and that this isomorphism sends $x \mapsto \alpha$. □

Exercises

1. Consider the graded vector space $V = \{V_i\}_{i \geq 0}$ and its graded dual $W = \text{Hom}(V, \mathbb{Q})$. Let $\Sigma_{p,q}$ denote the subgroup of permutations σ of the set $\{1, 2, \dots, p + q\}$ such that:

$$\sigma 1 < \sigma 2 < \dots < \sigma p \quad \text{and} \quad \sigma(p + 1) < \sigma(p + 2) < \dots < \sigma(p + q).$$

Define a product (called the *shuffle product*) on TW by:

$$\begin{aligned} [w_1 \otimes w_2 \otimes \dots \otimes w_p] \in T^p W, \quad [w'_1 \otimes w'_2 \otimes \dots \otimes w'_q] \in T^q W, \\ [w_1 \otimes w_2 \otimes \dots \otimes w_p] * [w'_1 \otimes w'_2 \otimes \dots \otimes w'_q] = \\ \sum_{\sigma \in \Sigma_{p,q}} (-1)^{s\sigma} \left[w''_{\sigma_1} \otimes w''_{\sigma_2} \otimes \dots \otimes w''_{\sigma(p+q)} \right], \\ w''_{\sigma i} = \begin{cases} w_{\sigma i} & \text{if } 1 \leq \sigma i \leq p \\ w'_{\sigma i - p} & \text{if } p + 1 \leq \sigma i \leq p + q \end{cases} \end{aligned}$$

Here $s\sigma$ denotes the graded signature. Prove that the coproduct defined on TV in §3-exercise 4 dualizes the product $*$ on TW .

2. Determine the algebra $H_*(\Omega \mathbb{C}P^n; \mathbb{Q})$ for $n \geq 2$.
3. Let X be a finite product of simply connected Eilenberg-MacLane spaces. Determine the algebra $H_*(\Omega X; \mathbb{Q})$.
4. Let X be a simply connected homogeneous space. Prove that all triple Whitehead products are trivial in $\pi_*(X) \otimes \mathbb{Q}$.
5. Determine, up through dimension 5, the Sullivan minimal model of $X = S^2_a \vee S^2_b \cup_{[a, [a, b]_W]_W} D^5$. Does the subalgebra $H_*(\Omega(S^2 \vee S^2)); \mathbb{Q}$ generate the algebra $H_*(\Omega X; \mathbb{Q})$?
6. Prove that, up through dimension 5, the Sullivan minimal model of $S^2 \vee S^2 \vee S^5$ is given by $\wedge V = \wedge(x_1, x_2, x_3, y_1, y_2, y_3, z_1, z_2, \dots)$ with $V = \{V_i^n\}$ and $x_1, x_2 \in V_0^2, x_3 \in V_0^5, dV_i^n \subset (\wedge V)_{i-1}^{n+1}, dy_1 = x_1^2, dy_2 = x_1 x_2, dy_3 = x_2^2, dz_1 = x_1 y_2 - x_2 y_1, dz_2 = x_1 y_2 - x_2 y_2$ (see §13-exercise 4). Compute the Whitehead products

$[\alpha, \beta]_W = 0$ for every $\alpha \in \pi_2(S^2 \vee S^2 \vee S^5) \otimes \mathbb{Q}$ and $\beta \in \pi_3(S^2 \vee S^2 \vee S^5) \otimes \mathbb{Q}$. Let $D : V \rightarrow \wedge V$ be a linear map such that $D - d(V_i) \subset (\wedge V)_{<i-2}$. Prove that D extends to a differential on $\wedge V$ (cf. exercise 5).

7. Let $V = \mathbb{Z}x \oplus \mathbb{Z}y$ be the graded vector space generated by the $x \in V_p$ and $y \in V_q$, $p, q \geq 2$. Prove that $((\mathbb{Z} \oplus V) \otimes T(sV), d)$, with $dx = 0 = dy$ and for $sa_1 sa_2 \dots sa_k \in T^k(sV)$, $d(sa_1 sa_2 \dots sa_k) = a_1 \otimes sa_2 \dots sa_k$ is a $T(sV)$ -semifree resolution of the field \mathbb{Z} . Deduce that $H_*(\Omega(S^p))$ is isomorphic to the graded vector space $T(sV)$.

17 Spatial realization

In §17(a), the ground ring is an arbitrary commutative ring, k . In the rest of §17, k is a field of characteristic zero. Occasionally we specify $k = \mathbb{Q}$.

We began Part II with the construction, in §10, of the (contravariant) functor A_{PL} from topological spaces to commutative cochain algebras. Now, at the conclusion of Part II, we reverse the process, and construct the (contravariant) *spatial realization functor*

$$| \cdot | : \text{commutative cochain algebras} \rightsquigarrow \text{CW complexes.}$$

Recall that a Sullivan algebra $(\Lambda V, d)$ is simply connected of finite type if $V = \{V^p\}_{p \geq 2}$ and each V^p is finite dimensional. When $k = \mathbb{Q}$ the spatial realization functor has the following important properties:

- Any simply connected rational Sullivan algebra of finite type is a Sullivan model of its spatial realization:

$$(\Lambda V, d) \xrightarrow{\cong} A_{PL}(|\Lambda V, d|),$$

and this spatial realization is a simply connected rational topological space (Theorem 17.10).

- Any morphism $\varphi : (\Lambda V, d) \rightarrow (\Lambda W, d)$ of simply connected rational Sullivan algebras of finite type is a Sullivan representative of its spatial realization $|\varphi| : |\Lambda W, d| \leftarrow |\Lambda V, d|$, (17.14).
- Two morphisms $\varphi, \psi : (\Lambda V, d) \rightarrow (\Lambda W, d)$ between simply connected rational Sullivan algebras of finite type are homotopic if and only if the continuous maps $|\varphi|$ and $|\psi|$ are homotopic (Proposition 17.13 and §12(c)).
- Let $\varphi : (\Lambda V, d) \rightarrow (\Lambda W, d)$ be a rational Sullivan representative for a continuous map $f : X \rightarrow Y$ between simply connected CW complexes with rational homology of finite type. Then there is a homotopy commutative diagram

$$\begin{array}{ccc} X & \xrightarrow{f} & Y \\ h_X \downarrow & & \downarrow h_Y \\ |\Lambda W, d| & \xrightarrow{|\varphi|} & |\Lambda V, d| \end{array}$$

in which $\pi_*(h_X) \otimes \mathbb{Q}$ and $\pi_*(h_Y) \otimes \mathbb{Q}$ are isomorphisms (Theorem 17.15).

From these properties it is easy to deduce (and we leave this to the reader) the bijections

$$\left\{ \begin{array}{c} \text{rational homotopy} \\ \text{types} \end{array} \right\} \xrightarrow{\cong} \left\{ \begin{array}{c} \text{isomorphism classes of} \\ \text{minimal Sullivan algebras} \\ \text{over } \mathbb{Q} \end{array} \right\}$$

and

$$\left\{ \begin{array}{l} \text{homotopy classes of} \\ \text{continuous maps of} \\ \text{rational spaces} \end{array} \right\} \xrightarrow{\cong} \left\{ \begin{array}{l} \text{homotopy classes of} \\ \text{morphisms of Sullivan algebras} \\ \text{over } \mathbb{Q} \end{array} \right\}$$

promised at the start of §12. (Note that for these bijections we restrict to simply connected CW complexes with rational homology of finite type and to simply connected Sullivan algebras of finite type.)

The spatial realization functor, $| \quad |$, is constructed as the composite of two others. The first is Sullivan's simplicial realization functor [144]

$$\langle \quad \rangle : \text{commutative cochain algebras} \rightsquigarrow \text{simplicial sets} ,$$

which is the adjoint of $A_{PL}(-)$, and the second is Milnor's realization functor ([126])

$$| \quad | : \text{simplicial sets} \rightsquigarrow \text{CW complexes} .$$

In describing Milnor's functor we shall only sketch some of the proofs, referring to May's elegant exposition [122] for details.

We complete this section by using integration to define a natural quasi-isomorphism

$$C_* \langle \Lambda V, d \rangle \xrightarrow{\cong} \text{Hom}((\Lambda V, d), k) ,$$

compatible with geometric products.

This section is organized into the following topics:

- (a) The Milnor realization of a simplicial set.
- (b) Products and fibre bundles.
- (c) The Sullivan realization of a commutative cochain algebra.
- (d) The spatial realization of a Sullivan algebra.
- (e) Morphisms and continuous maps.
- (f) Integration, chain complexes and products.

(a) The Milnor realization of a simplicial set.

Recall the definition of a simplicial set from §10(a), with face and degeneracy maps ∂_i and s_j . Recall also that in §4(a) we introduced the geometric face and degeneracy maps $\lambda_i = \langle e_0 \cdots \hat{e}_i \cdots e_n \rangle : \Delta^{n-1} \rightarrow \Delta^n$ and $\rho_j = \langle e_0 \cdots e_j e_j \cdots e_n \rangle : \Delta^{n+1} \rightarrow \Delta^n$.

Now let K be a simplicial set. Give each K_n the discrete topology. Then the *Milnor realization of K* is the topological space

$$|K| = \left(\coprod_n K_n \times \Delta^n \right) / \sim ,$$

where \sim is the equivalence relation generated by the relations

$$\partial_i \sigma \times x \sim \sigma \times \lambda_i x \quad , \quad \sigma \in K_{n+1}, x \in \Delta^n$$

and

$$s_j \sigma \times x \sim \sigma \times \rho_j x \quad , \quad \sigma \in K_n, x \in \Delta^{n+1} .$$

This construction is functorial: if $f : K \rightarrow L$ is a morphism of simplicial sets then $f = \{f_n : K_n \rightarrow L_n\}$ and the continuous maps $f_n \times id : K_n \times \Delta^n \rightarrow L_n \times \Delta^n$ factor to define the continuous map

$$|f| : |K| \rightarrow |L| .$$

Recall that the face and degeneracy maps of a simplicial set satisfy the commutation relations (10.2). A simplex $\sigma \in K_n$ is *degenerate* if $\sigma = s_j \tau$, some $\tau \in K_{n-1}$; otherwise it is *non-degenerate*. The set of non-degenerate n -simplices is denoted NK_n (cf. §10(a)).

Recall further that $\partial \Delta^n = \bigcup_i \lambda_i(\Delta^{n-1})$ and put $\overset{\circ}{\Delta}^n = \Delta^n - \partial \Delta^n$.

Lemma 17.1 [122] *The quotient map $q_K : \coprod_n K_n \times \Delta^n \rightarrow |K|$ restricts to a bijection*

$$\tilde{q}_K : \coprod_n NK_n \times \overset{\circ}{\Delta}^n \rightarrow |K| .$$

proof: Denote q_K simply by q . If $\sigma \times x \in K_n \times \Delta^n$ choose the least k such that $q(\sigma \times x) = q(\tau \times y)$ for some $(\tau, y) \in K_k \times \Delta^k$. Then τ cannot be degenerate (if $\tau = s_j \omega$ then $\tau \times y \sim \omega \times \rho_j y$) and $y \in \overset{\circ}{\Delta}^k$ (if $y = \lambda_i z$ then $\tau \times y \sim \partial_i \tau \times z$). Hence \tilde{q} is surjective. A tedious computation using the commutation formulae (10.2) shows that \tilde{q} is injective. \square

Suppose $L \subset K$ is a sub-simplicial set. If $\sigma \in L_n$ and $\sigma = s_j \tau$, $\tau \in K_{n-1}$ then $\tau = \partial_j s_j \tau = \partial_j \sigma \in L_{n-1}$. Thus it follows from Lemma 17.1 that $|L| \subset |K|$. In particular, recall from §10(a) that the n -skeleton of K is the sub simplicial set $K(n)$ determined by

$$N(K(n)_k) = \begin{cases} NK_k & k \leq n \\ \emptyset & k > n . \end{cases}$$

Thus $|K(n)| \subset |K|$.

Proposition 17.2 [122] *The Milnor realization $|K|$ of a simplicial set K is a CW complex with n -skeleton $|K(n)|$ and n -cells the non-degenerate n -simplices $\sigma \in NK_n$. The attaching map for σ is the restriction of q_K to $\{\sigma\} \times \partial \Delta^n$.*

proof: Let $\sigma \in K_n$. The quotient map $q : \coprod_n K_n \times \Delta^n \rightarrow |K|$ satisfies $q(\sigma \times \lambda_i x) = q(\partial_i \sigma \times x)$ and it follows that q restricts to a continuous map $q_\sigma :$

$\{\sigma\} \times \partial\Delta^n \rightarrow |K(n-1)|$. Thus, because of Lemma 17.1, q induces a continuous bijection

$$q(n) : |K(n-1)| \cup_{(q_\sigma)} \left(\coprod_{\sigma \in NK_n} \{\sigma\} \times \Delta^n \right) \rightarrow |K(n)| .$$

A straightforward check shows that the $q(n)$ are proper, and hence homeomorphisms. Thus the $q(n)$ define a continuous bijection to $|K|$ from a CW complex with the desired properties. This is also proper, and hence a homeomorphism. \square

Example 1 $|\Delta[n]| = \Delta^n$.

In §10(a) we introduced the simplicial set $\Delta[n]$ whose k -simplices are the linear maps

$$\langle e_{i_0} \cdots e_{i_k} \rangle : \Delta^k \rightarrow \Delta^n, \quad 0 \leq i_0 \leq \cdots \leq i_k \leq n .$$

The identity map of Δ^n is thus an n -simplex ι of $\Delta[n]$, and it is straightforward to check that $q_{\Delta[n]}$ restricts to a homeomorphism $\{\iota\} \times \Delta^n \xrightarrow{\cong} |\Delta[n]|$. \square

Example 2 *Cones.*

The 'simplicial point' is the unique simplicial set with a single k -simplex c_n in each dimension. Now suppose K is any simplicial set. We extend the face and degeneracy maps in $\{K_n \amalg \{c_n\}\}_{n \geq 0}$ to the sequence of sets

$$(CK)_n = K_n \amalg \left(\coprod_{k=1}^{n-1} K_k \times \{c_{n-k-1}\} \right) \amalg \{c_n\}$$

by setting (for $\sigma \in K_k$):

$$\partial_i(\sigma, c_r) = \begin{cases} (\partial_i\sigma, c_r) & , i \leq k. \\ \sigma & , \text{if } r = 0 \text{ and } i = k + 1. \\ (\sigma, c_{r-1}) & , \text{otherwise.} \end{cases}$$

and

$$s_j(\sigma, c_r) = \begin{cases} (s_j\sigma, c_r) & , j \leq k. \\ (\sigma, c_{r+1}) & , \text{otherwise.} \end{cases}$$

This defines a simplicial set CK , the *cone on* K .

It follows now from Lemma 17.1 that $|CK| \cong |K| \times I / |K| \times \{1\}$. In particular,

- for any simplicial set K the realization $|CK|$ of the cone on K is a contractible CW complex. \square

Example 3 *Extendable simplicial sets.*

Recall from §10(a) that a simplicial set K is *extendable* if for any $n \geq 1$ and any $\mathcal{I} \subset \{0, \dots, n\}$ the following condition holds: given $\sigma_i \in K_{n-1}$, $i \in \mathcal{I}$ and satisfying $\partial_i\sigma_j = \partial_{j-1}\sigma_i$, $i < j$, then there exists $\sigma \in K_n$ such that $\partial_i\sigma = \sigma_i$, $i \in \mathcal{I}$. We observe now that

- If K is an extendable simplicial set then $|K|$ is contractible.

Indeed, extendable simplicial sets K have the property that if E is sub simplicial set of a simplicial set L then any morphism $\varphi : E \rightarrow K$ extends to a morphism $L \rightarrow K$. (This was proved in Proposition 10.4(ii) for simplicial cochain complexes, but the argument applies verbatim to simplicial sets.)

In particular the identity of K extends to a morphism $\psi : CK \rightarrow K$. Thus $id_{|K|} = |\psi| \circ |\lambda|$ where $\lambda : K \rightarrow CK$ is the inclusion. Since $|CK|$ is contractible, $id_{|K|} \sim$ constant map; i.e. $|K|$ is contractible. \square

Let K be a simplicial set. Just as we defined the cochain algebra $C^*(K)$ in §10(d) so we now introduce the *differential graded coalgebra*, $C_*(K)$, defined as follows:

- $C_*(K) = \{C_n(K)\}_{n \geq 0}$ and $C_n(K)$ is the free \mathbb{k} -module on K_n divided by the submodule spanned by the degenerate simplices.
- The comultiplication Δ in $C_*(K)$ is given by

$$\Delta\sigma = \sum_{p=0}^n \partial_p \partial_{p+1} \cdots \partial_n \sigma \otimes \partial_0 \cdots \partial_0 \sigma, \quad \sigma \in K_n.$$

- The differential d is given by

$$d\sigma = \sum_{p=0}^n (-1)^p \partial_p \sigma, \quad \sigma \in K_n.$$

The reader will immediately see that this generalizes the construction in §4(a): if X is a topological space then $C_*(X) = C_*(S_*(X))$. Moreover $C^*(K)$ is the cochain algebra $\text{Hom}(C_*(K), \mathbb{k})$, exactly as in the case of topological spaces.

If K is any simplicial set then the continuous map q_K of Lemma 17.1 restricts to continuous maps $q_\sigma : \{\sigma\} \times \Delta^n \rightarrow |K|$, $\sigma \in K_n$. This defines an inclusion of simplicial sets,

$$\xi_K : K \rightarrow S_*(|K|), \quad \xi_K : \sigma \mapsto q_\sigma,$$

where $S_*(-)$ denotes the simplicial set of singular simplices defined in §10(a).

Observe now that ξ_K maps the non-degenerate simplices of K bijectively to singular simplices of $|K|$ that are the characteristic maps for the cells. This identifies $C_*(\xi_K)$ as a cellular chain model in the sense of Theorem 4.18. In particular, $H_*(\xi_K)$ is an isomorphism. Note as well that

$$C_*(\xi_K) : C_*(K) \rightarrow C_*(|K|)$$

is an inclusion, and identifies $C_*(K)$ as a sub dgc of $C_*(|K|)$.

On the other hand, Let X be any topological space, and define a continuous map $\coprod_n S_n(X) \times \Delta^n \rightarrow X$ by sending $\sigma \times y \mapsto \sigma(y)$. This factors over the quotient map $q_{S_*(X)}$ to produce the continuous map

$$s_X : |S_*(X)| \rightarrow X .$$

It is an interesting but reasonable exercise [122] to show that s_X is always a weak homotopy equivalence. We shall limit ourselves here to the easy case that X is a simply connected CW complex.

Proposition 17.3

- (i) *If X is a simply connected CW complex then s_X is a homotopy equivalence.*
- (ii) *If K is a simplicial set and $|K|$ is simply connected then $|\xi_K|$ is a homotopy equivalence.*

proof: (i) For simplicity put $Y = |S_*(X)|$ and $\xi = \xi_{S_*(X)} : S_*(X) \rightarrow S_*(Y)$. We show first that Y is simply connected. Indeed, since X is connected any two points $x, y \in X$ are connected by a singular 1-simplex $f : (I, 0, 1) \rightarrow (X, x, y)$. Thus any two 0-cells $\xi(x)$ and $\xi(y)$ in Y are connected by the 1-cell $\xi(f)$; i.e., Y is path connected.

If $g : (I, 0, 1) \rightarrow (X, y, z)$ we define

$$(f * g)(t) = \begin{cases} f(2t) & , 0 \leq t \leq \frac{1}{2} . \\ g(2t - 1) & , \frac{1}{2} \leq t \leq 1 . \end{cases}$$

Similarly, $f^{-1}(t) = f(1 - t)$. The homotopy class of f rel $\{0, 1\}$ is denoted by $[f]$ and an associative composition of homotopy classes is defined by $[f] * [g] = [f * g]$, — cf. §1.

Fix a 0-cell, ξx_0 , as a base point of Y . The Cellular approximation theorem 1.2 asserts that any loop in Y at ξx_0 can be deformed into the 1-skeleton Y_1 . The easy part of the Van Kampen theorem asserts that any element $\gamma \in \pi_1(Y_1, \xi x_0)$ can be written in the form $[\xi f_0]^{\pm 1} * \dots * [\xi f_n]^{\pm 1}$ where the ξf_i are 1-cells in Y .

There are obvious singular 2-simplices

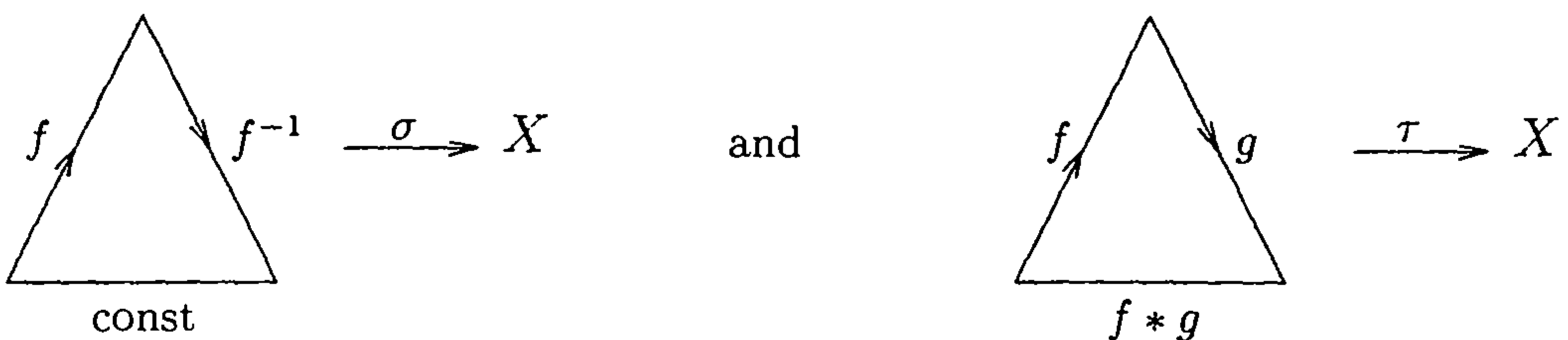

and $\xi\sigma$ and $\xi\tau$ are singular 2-simplices in Y that provide homotopies $\xi f^{-1} \sim (\xi f)^{-1} \text{ rel } \{0, 1\}$ and $\xi f * \xi g \sim \xi(f * g) \text{ rel } \{0, 1\}$. Let $f = f_0^{\pm 1} * \dots * f_n^{\pm 1}$, where we have removed the (necessary) brackets for simplicity. Then f is a loop in X at x_0 and our observations imply $\gamma = [\xi f]$. Since X is simply connected there is a singular 2-simplex

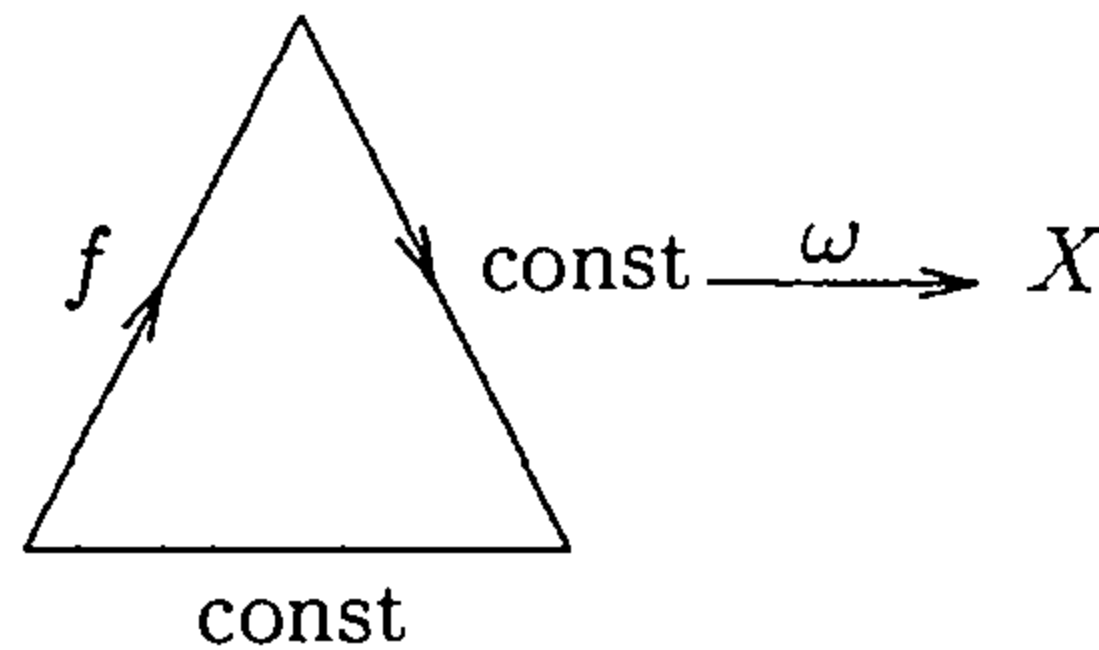

and $\xi\omega$ is a homotopy from ξf to the constant loop. Hence $\pi_1(Y) = \{0\}$.

Next recall that $H_*(\xi_K; \mathbb{Z})$ is an isomorphism for any simplicial set K . In particular, $H_*(\xi; \mathbb{Z})$ is an isomorphism. But the continuous map $s_X : Y \rightarrow X$ induces $S_*(s_X) : S_*(Y) \rightarrow S_*(X)$, and it is immediate from the definitions that $\xi : S_*(X) \rightarrow S_*(Y)$ satisfies $S_*(s_X)\xi = id$. Thus $H_*(s_X; \mathbb{Z})$ is an isomorphism. Since a homology isomorphism between simply connected spaces is a weak homotopy equivalence (Theorem 8.6) and a weak homotopy equivalence between CW complexes is a homotopy equivalence (Corollary 1.7), assertion (i) is established.

(ii) Assertion (i) states that $s_{|K|} : |S_*(|K|)| \rightarrow |K|$ is a homotopy equivalence. It is immediate from the definition that $s_{|K|} \circ |\xi_K| = id$. Thus $|\xi_K|$ is a homotopy equivalence. □

(b) Products and fibre bundles.

The *product* of two simplicial sets K and L is the simplicial set $K \times L = (\{K_n \times L_n\}, \partial_i \times \partial_i, s_j \times s_j)$. If $K \xrightarrow{\varphi} E \xleftarrow{\psi} L$ are morphisms of simplicial sets then the *fibre product* $K \times_E L \subset K \times L$ is the sub simplicial set defined by $(K \times_E L)_n = \{(\sigma, \tau) \mid \varphi\sigma = \psi\tau\}$.

Now the projections $\rho_K : K \times L \rightarrow K$ and $\rho_L : K \times L \rightarrow L$ are morphisms of simplicial sets. Set

$$f = (|\rho_K|, |\rho_L|) : |K \times L| \rightarrow |K| \times |L| .$$

Proposition 17.4

(i) The continuous map f is a natural homeomorphism $|K \times L| \xrightarrow{\cong} |K| \times |L|$.

(ii) Furthermore, f restricts to a homeomorphism $|K \times_E L| \xrightarrow{\cong} |K| \times_{|E|} |L|$.

proof: We first introduce some notation. Given a surjective map $\alpha : \{0, \dots, n\} \rightarrow \{0, \dots, k\}$ such that $0 = \alpha(0) \leq \dots \leq \alpha(n) = k$ we put

$\varrho_\alpha = \langle e_{\alpha(0)} \cdots e_{\alpha(n)} \rangle : \Delta^n \rightarrow \Delta^k$. Then ϱ_α is a composite of degeneracy maps: $\varrho_\alpha = \varrho_{i_1} \circ \cdots \circ \varrho_{i_{n-k}}$, and in any simplicial set K the map $s_\alpha = s_{i_{n-k}} \circ \cdots \circ s_{i_1} : K_k \rightarrow K_n$ depends only on α and not on the choice of decomposition (use the commutation formulae (10.2)). Moreover the map q_K of Lemma 17.1 identifies $s_\alpha \sigma \times y$ with $\sigma \times \varrho_\alpha y$.

We now turn to the actual proof.

(i) It is immediate that f is proper and so we only need to show it is bijective. We do so via Lemma 17.1. Any simplex in $(K \times L)_n$ has the form $\omega = (s_\alpha \sigma, s_\beta \tau)$ with $\sigma \in NK_p$ and $\tau \in NK_q$ and it is degenerate precisely if $s_\alpha = s_i s_{\alpha'}$, and $s_\beta = s_i s_{\beta'}$ for some i . This is equivalent to: $\alpha(i) = \alpha(i+1)$ and $\beta(i) = \beta(i+1)$. Thus the non-degenerate simplices are the $(s_\alpha \sigma, s_\beta \tau)$ with $\alpha(i) + \beta(i) < \alpha(i+1) + \beta(i+1)$, all i .

Now $f : \{\omega\} \times \overset{\circ}{\Delta}^n \rightarrow \left(\{\sigma\} \times \overset{\circ}{\Delta}^p \right) \times \left(\{\tau\} \times \overset{\circ}{\Delta}^q \right)$, where $n = n(\alpha, \beta)$ is the dimension of ω . We denote this restriction by $f_{\alpha, \beta} : \overset{\circ}{\Delta}^n \xrightarrow{(\alpha, \beta)} \overset{\circ}{\Delta}^p \times \overset{\circ}{\Delta}^q$. We have to show that each $f_{\alpha, \beta}$ is injective and that

$$\overset{\circ}{\Delta}^p \times \overset{\circ}{\Delta}^q = \coprod_{\alpha, \beta} f_{\alpha, \beta} \left(\overset{\circ}{\Delta}^{n(\alpha, \beta)} \right), \quad (17.5)$$

where the α, β run over all the non-decreasing sequences such that $\omega = (s_\alpha \sigma, s_\beta \tau)$ is non-degenerate.

Regard $\overset{\circ}{\Delta}^p \times \overset{\circ}{\Delta}^q$ as a subset of $\mathbb{R}^{p+1} \times \mathbb{R}^{q+1}$. Then $f_{\alpha, \beta}$ is the linear map defined by $e_i \mapsto (e_{\alpha(i)}, e_{\beta(i)})$, $0 \leq i \leq n(\alpha, \beta)$. Since either $\alpha(i) < \alpha(i+1)$ or $\beta(i) < \beta(i+1)$ it is easy to see that $(e_{\alpha(0)}, e_{\beta(0)}), \dots, (e_{\alpha(n)}, e_{\beta(n)})$ are linearly independent in \mathbb{R}^{p+q+2} . Hence each $f_{\alpha, \beta}$ is injective. Formula (17.5) is a straightforward computation.

(ii) By definition f restricts to a continuous injection $f_E : |K \times_E L| \rightarrow |K| \times_{|E|} |L|$ and this is proper because $|K \times_E L|$ is closed in $|K \times L|$. We have only to show that f_E is surjective.

Suppose that $\omega = (s_\alpha \sigma, s_\beta \tau)$ is a non-degenerate n -simplex in $K \times L$ (as described in the proof of (i)) and that $y \in \overset{\circ}{\Delta}^n$. Then $f q_{K \times L}(\omega \times y) = (q_K(\sigma \times \varrho_\alpha y), q_L(\tau \times \varrho_\beta y))$. Suppose this point is in $|K| \times_{|E|} |L|$. Then

$$q_E(\varphi \sigma \times \varrho_\alpha y) = q_E(\varphi \tau \times \varrho_\beta y).$$

Write $\varphi \sigma = s_{\alpha'} \sigma'$ and $\varphi \tau = s_{\beta'} \tau'$, where σ' and τ' are non-degenerate in E . The equation above gives

$$q_E(\sigma', \varrho_{\alpha'} \varrho_\alpha y) = q_E(\tau', \varrho_{\beta'} \varrho_\beta y).$$

But $\varrho_\alpha : \overset{\circ}{\Delta}^n \rightarrow \overset{\circ}{\Delta}^p$ and similarly for ϱ_β , $\varrho_{\alpha'}$ and $\varrho_{\beta'}$. Thus Lemma 17.1 implies that $\sigma' = \tau'$ and $\varrho_{\alpha'} \varrho_\alpha y = \varrho_{\beta'} \varrho_\beta y$. Now $y = \sum_0^n t_i e_i$ and the condition $y \in \overset{\circ}{\Delta}^n$ means each $t_i > 0$. It follows that the equation $\varrho_{\alpha'} \varrho_\alpha y = \varrho_{\beta'} \varrho_\beta y$ implies

$\varrho_{\alpha'} \varrho_{\alpha} = \varrho_{\beta'} \varrho_{\beta}$, whence $s_{\alpha} s_{\alpha'} = s_{\beta} s_{\beta'}$. Thus $\varphi s_{\alpha} \sigma = s_{\alpha} s_{\alpha'} \sigma' = s_{\beta} s_{\beta'} \tau' = \varphi s_{\beta} \tau'$; i.e. $\omega \in (K \times_E L)_n$ and $q_{K \times L}(\omega \times y) \in |K \times_E L|$. \square

Recall from §2(d) that a fibre bundle with fibre Z is a continuous map $p : X \rightarrow Y$ such that for some open cover $\{U_{\alpha}\}$ of Y we have: $p^{-1}(U_{\alpha}) \cong U_{\alpha} \times Z$, compatibly with the projection on U_{α} .

There is a useful simplicial analogue of this “local product structure.” Let L be a simplicial set. As we observed in §10(a) any simplex $\sigma \in L_n$ determines a unique simplicial map $\sigma_* : \Delta[n] \rightarrow L$ such that $\sigma_*(id_{\Delta^n}) = \sigma$. Thus given a morphism of simplicial sets $\varrho : K \rightarrow L$ and $\sigma \in L_n$, we can form the fibre product $\Delta[n] \times_L K$.

We define a *simplicial fibre bundle with fibre F* to be a morphism $\varrho : K \rightarrow L$ of simplicial sets such that for each $n \geq 0$ and each $\sigma \in L_n$ there is a commutative diagram

$$\begin{array}{ccc} \Delta[n] \times F & \xrightarrow[\cong]{\varphi_{\sigma}} & \Delta[n] \times_L K \\ \text{proj} \searrow & & \swarrow \text{proj} \\ & \Delta[n] & \end{array}$$

in which φ_{σ} is an isomorphism of simplicial sets.

Remark Note that a simplicial fibre bundle is *not* a simplicial object in the category of fibre bundles!

Proposition 17.6 *If $\varrho : K \rightarrow L$ is a simplicial fibre bundle with fibre F then $|\varrho| : |K| \rightarrow |L|$ is a fibre bundle with fibre $|F|$.*

proof: Recall from §17(a) that the cells of $|L|$ are the non-degenerate simplices σ of L and that the characteristic maps are the maps $q_{\sigma} : \{\sigma\} \times \Delta^n \rightarrow |L|$. It is immediate from the definitions (cf. Example 1 of §17(a)) that

$$q_{\sigma} = |\sigma_*| : |\Delta[n]| \rightarrow |L| .$$

Thus the pullback of $|\varrho|$ to an n -cell is just the fibre product $|\Delta[n]| \times_{|L|} |K|$ defined with respect to $|\sigma_*| : |\Delta[n]| \rightarrow |L|$ and $|\varrho| : |K| \rightarrow |L|$.

Now apply Proposition 17.4 to translate the simplicial diagrams above to the commutative topological diagrams

$$\begin{array}{ccc} |\Delta[n]| \times |F| & \xrightarrow[\cong]{|\varphi_{\sigma}|} & |\Delta[n]| \times_{|L|} |K| \\ \text{proj} \searrow & & \swarrow \text{proj} \\ & |\Delta[n]| & \end{array}$$

These show that $|\varrho|$ pulls back to a product bundle with fibre $|F|$ over every cell. Thus Proposition 2.7 asserts that $|\varrho|$ is a fibre bundle with fibre $|F|$. \square

Example 1 *A simplicial construction of the Eilenberg-MacLane space $K(\mathbb{k}, 1)$.*

Recall that \mathbb{k} is our ground field of characteristic zero. Here we think of it simply as an abelian group under addition. In §10(c) we introduced the simplicial cochain algebra $A_{PL} = \{(A_{PL})_n\}$. Thus each A_{PL}^p is a simplicial vector space. Let d be the differential in A_{PL} ; then each $(\ker d)^p$ is a sub simplicial vector space of A_{PL}^p . Put $Z = (\ker d)^1$. We shall show that

- $|Z|$ is an Eilenberg-MacLane space, $K(\mathbb{k}, 1)$.

For this let $[k]$ be the simplicial vector space given by $[k]_n = \mathbb{k}$, $\partial_i = id$, $s_j = id$. Since $H((A_{PL})_n, d) = \mathbb{k}$, $n \geq 0$, (Lemma 10.7),

$$0 \longrightarrow [k] \longrightarrow A_{PL}^0 \xrightarrow{d} Z \longrightarrow 0$$

is a short exact sequence of simplicial vector spaces.

Let $\sigma_* : \Delta[n] \rightarrow Z$ be the simplicial map determined by any fixed $\sigma \in Z_n$. We show that there is an isomorphism

$$\varphi_\sigma : \Delta[n] \times [k] \cong \Delta[n] \times_Z A_{PL}^0,$$

coherent with the projections on $\Delta[n]$. For this, fix $\tau \in (A_{PL})_n^0$ satisfying $d\tau = \sigma$. If $\alpha \in \Delta[n]_k$ and $\lambda \in [k]_k = \mathbb{k}$, define $\varphi_\sigma(\alpha, \lambda) = (\alpha, \tau_*(\alpha) + \lambda)$. It is immediate from the definition that φ_σ is a simplicial isomorphism.

We may now apply Proposition 17.6 to conclude that

$$|d| : |A_{PL}^0| \longrightarrow |Z| \tag{17.7}$$

is a fibre bundle with fibre $|[k]|$. The elements of $[k]_0 (= \mathbb{k})$ are the only non-degenerate simplices, and this identifies $|[k]| = \mathbb{k}$, equipped with the discrete topology. (For example, if $\mathbb{k} = \mathbb{R}$ or \mathbb{Q} , this is *not* the standard topology!) Thus $|d|$ is a covering projection with discrete fibre, \mathbb{k} . Since A_{PL}^0 is extendable (Lemma 10.7), $|A_{PL}^0|$ is contractible (Example 3, §17(a)).

Finally, note that addition in each $(A_{PL})_n^0$ defines a simplicial morphism $A_{PL}^0 \times A_{PL}^0 \rightarrow A_{PL}^0$, which restricts to $\alpha : A_{PL}^0 \times [k] \rightarrow A_{PL}^0$. This realizes to a continuous map

$$|\alpha| : |A_{PL}^0| \times \mathbb{k} \longrightarrow |A_{PL}^0|.$$

In the same way addition defines a simplicial morphism $[k] \times [k] \rightarrow [k]$, which realizes to ordinary addition in \mathbb{k} . Thus $|\alpha|$ defines an action of the additive group of \mathbb{k} on $|A_{PL}^0|$ and this identifies \mathbb{k} with the group of covering transformations of the covering projection (17.7). Since $|A_{PL}^0|$ is contractible it follows that $\mathbb{k} \cong \pi_1(|Z|)$ and $\pi_{\geq 2}(|Z|) = 0$. Thus $|Z|$ is a $K(\mathbb{k}, 1)$.

It is useful to identify the isomorphism $\mathbb{k} \xrightarrow{\cong} \pi_1(|Z|)$ explicitly. For this fix as basepoints of $|Z|$ and $|A_{PL}^0|$ the 0-cells z_0 and a_0 corresponding to the zero

elements of Z_0 and $(A_{PL})_0^0$. Note also that each $\lambda \in \mathbb{k} = (A_{PL})_0^0$ determines a 0-cell a_λ in $|A_{PL}^0|$. Now recall (§10(c)) that $(A_{PL})_1 = \Lambda(t_1, dt_1)$. For each $\lambda \in \mathbb{k}$ the element $\lambda dt_1 \in Z_1^1$ defines a 1-cell in $|Z|$ that is a loop g_λ at z_0 . Its lift is the 1-cell in $|A_{PL}^0|$ corresponding to $\lambda t_1 \in (A_{PL})_1^0$ and this is a path f_λ from a_0 to a_λ . Thus

- The isomorphism $\mathbb{k} \xrightarrow{\cong} \pi_1(|Z|, z_0)$ is given by $\lambda \mapsto [g_\lambda]$.

□

(c) The Sullivan realization of a commutative cochain algebra.

Recall again from §10(c) the simplicial cochain algebra $(A_{PL}, \partial_i, s_j)$. It may be thought of as a sort of ‘generalized point’. From this perspective the Sullivan realization of a commutative cochain algebra (A, d) is analogous to the construction of an algebraic variety V_R from a noetherian commutative algebra R . The points of V_R are just the algebra morphisms $R \rightarrow \mathbb{k}$. Analogously, we make the

Definition The *Sullivan realization* is the contravariant functor $(A, d) \mapsto \langle A, d \rangle$ from commutative cochain algebras to simplicial sets, given by:

- The n -simplices of $\langle A, d \rangle$ are the dga morphisms $\sigma : (A, d) \rightarrow (A_{PL})_n$.
- The face and degeneracy operators are given by $\partial_i \sigma = \partial_i \circ \sigma$ and $s_j \sigma = s_j \circ \sigma$.
- If $\varphi : (A, d) \rightarrow (B, d)$ is a morphism of commutative cochain algebras then $\langle \varphi \rangle : \langle A, d \rangle \leftarrow \langle B, d \rangle$ is the simplicial morphism given by $\langle \varphi \rangle(\sigma) = \sigma \circ \varphi$, $\sigma \in \langle B, d \rangle_n$.

Denote by $DGA(-, -)$ and by $\text{Simpl}(-, -)$ the set of morphisms between two dga’s, and between two simplicial sets. (Thus $\langle A, d \rangle_n = DGA((A, d), (A_{PL})_n)$.) Recall from §10(b) and §10(c) that if K is a simplicial set then $A_{PL}(K) = \text{Simpl}(K, A_{PL})$ is the cochain algebra of simplicial morphisms from K to A_{PL} . Thus a natural bijection

$$DGA((A, d), A_{PL}(K)) \xrightarrow{\cong} \text{Simpl}(K, \langle A, d \rangle) , \quad \varphi \mapsto f , \quad (17.8)$$

is defined by requiring

$$f(\sigma)(a) = \varphi(a)(\sigma) , \quad a \in A, \sigma \in K_n, n \geq 0 .$$

This establishes $A_{PL}(-)$ and $\langle \ \rangle$ as *adjoint functors* between commutative cochain algebras and simplicial sets. In particular, adjoint to the identity of $\langle A, d \rangle$ is the canonical dga morphism

$$\eta_A : (A, d) \rightarrow A_{PL}\langle A, d \rangle .$$

Combining Sullivan’s functor with Milnor’s realization gives the fundamental

Definition The *spatial realization* of a commutative cochain algebra (A, d) is the CW complex $|A, d| = |\langle A, d \rangle|$. The *spatial realization* of a morphism $\varphi : (A, d) \rightarrow (B, d)$ is the continuous map $|\varphi| = |\langle \varphi \rangle|$.

Example 1 *Products.*

Let (A, d) and (B, d) be commutative cochain algebras. A pair of morphisms $\varphi : (A, d) \rightarrow (A_{PL})_n$ and $\psi : (B, d) \rightarrow (A_{PL})_n$ extend uniquely to the morphism $\varphi \cdot \psi : (A, d) \otimes (B, d) \rightarrow (A_{PL})_n$. Thus restriction to A and restriction to B defines an isomorphism of simplicial sets

$$\langle (A, d) \otimes (B, d) \rangle \xrightarrow{\cong} \langle A, d \rangle \times \langle B, d \rangle .$$

On the other hand, Milnor's realization converts simplicial products to topological products (Proposition 17.4). Thus we obtain a natural homeomorphism

$$|(A, d) \otimes (B, d)| \xrightarrow{\cong} |A, d| \times |B, d| . \quad \square$$

Example 2 *Contractible Sullivan algebras have contractible realizations.*

Suppose $A = (\Lambda(U \oplus dU), d)$ is a contractible Sullivan algebra, and let $\{u_\alpha\}$ be a basis of U . An element of $\langle A \rangle_n$ is a morphism $\varphi : A \rightarrow (A_{PL})_n$, and so an isomorphism

$$\langle A \rangle \xrightarrow{\cong} \prod_{\alpha} (A_{PL})_{|u_\alpha|}$$

is given by $\varphi \mapsto \{\varphi u_\alpha\}$. By Lemma 10.7 each $(A_{PL})_{|u_\alpha|}$ is extendable, and hence so is the product (a trivial exercise). It follows (Example 3, §17(a)) that $|A|$ is contractible. □

More generally, we shall see now that spatial realization converts relative Sullivan algebras (§14) to fibre bundles with geometric fibre the realization of the Sullivan fibre. (This is the obverse of the theorem in §15 that in the Sullivan model of a fibration the fibre of the model is a model of the fibre.)

More precisely, fix a relative Sullivan algebra

$$\lambda : (B, d) \rightarrow (B \otimes \Lambda V, d)$$

such that $\text{Im } d \subset (B^+ \otimes \Lambda V) \oplus (\mathbb{k} \otimes \Lambda V)$. Dividing by $B^+ \otimes \Lambda V$ defines a Sullivan algebra $(\Lambda V, \bar{d})$.

Proposition 17.9 *The continuous map $|\lambda| : |B \otimes \Lambda V, d| \rightarrow |B, d|$ is a fibre bundle with fibre $|\Lambda V, \bar{d}|$.*

proof: In view of Proposition 17.6 it is sufficient to identify $\langle \lambda \rangle : \langle B \otimes \Lambda V, d \rangle \rightarrow \langle B, d \rangle$ as a simplicial fibre bundle with fibre $\langle \Lambda V, \bar{d} \rangle$. In other words we need to

show that for any $\sigma \in \langle B, d \rangle_n$ the corresponding fibre product (with respect to $\sigma_* : \Delta[n] \rightarrow \langle B, d \rangle$) satisfies

$$\Delta[n] \times_{(B,d)} \langle B \otimes \Lambda V, d \rangle \cong \Delta[n] \times \langle \Lambda V, \bar{d} \rangle ,$$

compatibly with the projections on $\Delta[n]$.

Now σ is a dga morphism $(B, d) \rightarrow (A_{PL})_n$. Moreover, for any $\alpha \in \Delta[n]_k$, α is a linear map $\Delta^k \rightarrow \Delta^n$ and $\sigma_*(\alpha) = A_{PL}(\alpha) \circ \sigma$, as follows at once from the definitions. Thus the k -simplices in the fibre product above are the pairs (α, τ) where $\alpha \in \Delta[n]_k$ and $\tau : (B \otimes \Lambda V, d) \rightarrow (A_{PL})_k$ satisfy $\tau \circ \lambda = A_{PL}(\alpha)\sigma$.

Let $((A_{PL})_n \otimes \Lambda V, d) = (A_{PL})_n \otimes_B (B \otimes \Lambda V, d)$ be the pushout relative Sullivan algebra (§14(a)) defined via σ . Since $(A_{PL})_n = A_{PL}(\Delta[n])$ (§10(c)) there is a unique simplicial morphism, $\Delta[n] \rightarrow \langle (A_{PL})_n \rangle$, adjoint to the identity of $(A_{PL})_n$. Our observations just above identify

$$\Delta[n] \times_{(B,d)} \langle B \otimes \Lambda V, d \rangle \cong \Delta[n] \times_{\langle (A_{PL})_n \rangle} \langle (A_{PL})_n \otimes \Lambda V, d \rangle ,$$

compatibly with the projections on $\Delta[n]$. On the other hand, $H((A_{PL})_n) = \mathbb{k}$ (Lemma 10.7). Thus the argument of Lemma 14.8, with $\mathbb{k} \rightarrow (A_{PL})_n$ replacing $(B_1, d) \rightarrow (B, d)$, shows that the identity of $(A_{PL})_n$ extends to a dga isomorphism $(A_{PL})_n \otimes \langle \Lambda V, \bar{d} \rangle \cong \langle (A_{PL})_n \otimes \Lambda V, d \rangle$. This identifies the right hand fibre product as $(\Delta[n] \times_{\langle (A_{PL})_n \rangle} \langle (A_{PL})_n \rangle) \times \langle \Lambda V, \bar{d} \rangle = \Delta[n] \times \langle \Lambda V, \bar{d} \rangle$. \square

(d) The spatial realization of a Sullivan algebra.

Fix a Sullivan algebra $(\Lambda V, d)$. By definition, $V = \{V^p\}_{p \geq 1}$ and so there is a unique augmentation $\varepsilon : (\Lambda V, d) \rightarrow \mathbb{k}$, which is then the unique 0-simplex in $\langle \Lambda V, d \rangle$ and the unique 0-cell in $|\Lambda V, d|$. Denote all these by ε .

In §17(a) we introduced the inclusion of simplicial sets $\xi = \xi_{(\Lambda V, d)} : \langle \Lambda V, d \rangle \rightarrow S_*(|\Lambda V, d|)$. Thus $A_{PL}(\xi)$ is surjective (Proposition 10.4). As described there for integral coefficients, $H_*(\xi; \mathbb{k})$ is an isomorphism, and so $A_{PL}(\xi)$ is a quasi-isomorphism. Thus in the diagram

$$\begin{array}{ccc} & & A_{PL}(|\Lambda V, d|) \\ & & \downarrow \simeq A_{PL}(\xi) \\ (\Lambda V, d) & \xrightarrow{\eta_{(\Lambda V, d)}} & A_{PL}(\langle \Lambda V, d \rangle) \end{array}$$

we may (Lemma 12.4) lift $\eta_{(\Lambda V, d)}$ through the surjective quasi-isomorphism $A_{PL}(\xi)$ to obtain a canonical homotopy class of dga morphisms

$$m_{(\Lambda V, d)} : (\Lambda V, d) \rightarrow A_{PL}(|\Lambda V, d|) .$$

We also want to compare $\text{Hom}_{\mathbb{k}}(V, \mathbb{k})$ with the homotopy groups $\pi_*(|\Lambda V, d|)$. To do so we shall rely on the notation, constructions and observations of §13(c), often without explicit reference, as well as to much of §12, which we also take for granted here. Thus if $a : (S^n, x_0) \rightarrow (|\Lambda V, d|, \varepsilon)$ represents $\alpha \in \pi_n(|\Lambda V, d|)$

then $A_{PL}(a) \circ m_{(\Lambda V, d)}$ lifts to a morphism φ_a from $(\Lambda V, d)$ to the minimal model of S^n , which has the form $(\Lambda(e), 0)$ or $(\Lambda(e, e'), de' = e^2)$ with $\text{dege} = n$.

Furthermore, φ_a restricts to a linear map $V^n \rightarrow \mathbb{k}e$ which depends only on α , and hence determines a map

$$\langle ; \rangle : V^n \times \pi_n(|\Lambda V, d|) \rightarrow \mathbb{k}, \quad \varphi_a v = \langle v; \alpha \rangle e.$$

These maps are linear in V^n and, if $n \geq 2$, additive in $\pi_n(|\Lambda V, d|)$. Thus the maps

$$\zeta_n : \pi_n(|\Lambda V, d|) \rightarrow \text{Hom}_{\mathbb{k}}(V, \mathbb{k}), \quad \zeta_n(\alpha)(v) = (-1)^n \langle v; \alpha \rangle,$$

are morphisms of abelian groups if $n \geq 2$.

Theorem 17.10 *Let $(\Lambda V, d)$ be a Sullivan algebra such that $H^1(\Lambda V, d) = 0$ and each $H^p(\Lambda V, d)$ is finite dimensional. Then*

(i) $|\Lambda V, d|$ is simply connected and $\zeta_n : \pi_n(|\Lambda V, d|) \xrightarrow{\cong} \text{Hom}_{\mathbb{k}}(V, \mathbb{k})$ is an isomorphism, $n \geq 2$.

(ii) If $\mathbb{k} = \mathbb{Q}$ then $m_{(\Lambda V, d)}$ is a quasi-isomorphism,

$$m_{(\Lambda V, d)} : (\Lambda V, d) \xrightarrow{\cong} A_{PL}(|\Lambda V, d|).$$

When $\mathbb{k} = \mathbb{Q}$ then *Theorem 17.10 exhibits any simply connected Sullivan algebra of finite type as the Sullivan model of a CW complex.*

proof of Theorem 17.10: We first reduce to the case $(\Lambda V, d)$ is minimal. Use Theorem 14.9 to write $(\Lambda V, d) = (\Lambda W, d) \otimes (\Lambda(U \oplus dU), d)$ with $(\Lambda W, d)$ minimal. Then $|\Lambda V, d|$ is the product of $|\Lambda W, d|$ and a contractible CW complex (Examples 1 and 2, §17(c)). It is thus sufficient to prove the theorem for $(\Lambda W, d)$. We may therefore assume that $(\Lambda V, d)$ itself is minimal. This implies that $V = \{V^p\}_{p \geq 2}$ and that each V^p is finite dimensional.

We shall rely on the following observation. Suppose $(\Lambda U, d) \rightarrow (\Lambda U \otimes \Lambda V, d)$ is a minimal relative Sullivan algebra in which $(\Lambda U, d)$ is itself a minimal Sullivan algebra. As in Proposition 17.9 this realizes to a fibre bundle $|\Lambda U \otimes \Lambda V, d| \xrightarrow{|\lambda|} |\Lambda U, d|$ with fibre $|\Lambda V, \bar{d}|$. In particular, $|\lambda|$ is a Serre fibration (Proposition 2.6). Let $\partial_* : \pi_* (|\Lambda U, d|) \rightarrow \pi_{*-1} (|\Lambda V, \bar{d}|)$ be the connecting homeomorphism.

Next, by adjointness we have the commutative diagram

$$\begin{array}{ccccc} (\Lambda U, d) & \longrightarrow & (\Lambda U \otimes \Lambda V, d) & \longrightarrow & (\Lambda V, \bar{d}) \\ \eta \downarrow & & \eta \downarrow & & \eta \downarrow \\ A_{PL}(\langle \Lambda U, d \rangle) & \longrightarrow & A_{PL}(\langle \Lambda U \otimes \Lambda V, d \rangle) & \longrightarrow & A_{PL}(\langle \Lambda V, \bar{d} \rangle) \end{array}$$

Use the Lifting lemma 14.4 to choose $m_{(\Lambda U, d)}$, $m_{(\Lambda U \otimes \Lambda V, d)}$ and $m_{(\Lambda V, \bar{d})}$ so that the diagram

$$\begin{array}{ccccc}
 (\Lambda U, d) & \longrightarrow & (\Lambda U \otimes \Lambda V, d) & \longrightarrow & (\Lambda V, \bar{d}) \\
 \downarrow m_{(\Lambda U, d)} & & \downarrow m_{(\Lambda U \otimes \Lambda V, d)} & & \downarrow m_{(\Lambda V, \bar{d})} \\
 A_{PL}(|\Lambda U, d|) & \longrightarrow & A_{PL}(|\Lambda U \otimes \Lambda V|, d) & \longrightarrow & A_{PL}(|\Lambda V, \bar{d}|)
 \end{array}$$

commutes.

Now the argument of Proposition 15.13 establishes that

$$\langle d_0 v; \alpha \rangle = (-1)^{n+1} \langle v; \partial_* \alpha \rangle, \quad v \in V^n, \alpha \in \pi_{n+1}(|\Lambda U|).$$

This translates to the commutative diagram

$$\begin{array}{ccc}
 \pi_{n+1}(|\Lambda U, d|) & \xrightarrow{\partial_*} & \pi_n(|\Lambda V, \bar{d}|) \\
 \downarrow \theta_{n+1} & & \downarrow \theta_n \\
 \text{Hom}_{\mathbb{k}}(U^{n+1}, \mathbb{k}) & \xrightarrow{-d_0^*} & \text{Hom}_{\mathbb{k}}(V^n, \mathbb{k}),
 \end{array} \tag{17.11}$$

in which d_0^* is the dual of $d_0 : (d_0^* f)(v) = (-1)^{n+1} f(d_0 v), v \in V^n$.

proof of (i): We turn now to the proof of (i), which is accomplished in stages.

Step 1: If $\deg v = 1$ then $|\Lambda(v), 0|$ is an Eilenberg-MacLane space $K(\mathbb{k}, 1)$, and θ_1 is an isomorphism.

Recall that $\langle \Lambda(v), 0 \rangle_n$ consists of the morphisms $\sigma : (\Lambda(v), 0) \rightarrow (A_{PL})_n$. Thus $\sigma v \in (\ker d)_n^1$. Since the morphism σ is determined by σv , an isomorphism of simplicial sets $\langle \Lambda(v), 0 \rangle \xrightarrow{\cong} (\ker d)^1$ is given by $\sigma \mapsto \sigma v$. Thus our assertion follows at once from the Example of §17(b).

Step 2: If $\deg v = n, n \geq 2$, then $|\Lambda(v), 0|$ is an Eilenberg-MacLane space $K(\mathbb{k}, n)$, and θ_n is an isomorphism.

Consider diagram (17.11) specialized to the case of the contractible Sullivan algebra $(\Lambda(v, w), dw = v)$, regarded as the relative Sullivan algebra $(\Lambda(v), 0) \rightarrow (\Lambda(v, w), d)$. Then d_0^* is an isomorphism by inspection, ∂_* is an isomorphism because $|\Lambda(v, w), d|$ is contractible (Example 2, §17(c)) and $\zeta_{n-1} : \pi_{n-1}(|\Lambda(w), 0|) \rightarrow \text{Hom}(\mathbb{k}w, \mathbb{k}) \cong \mathbb{k}$ is an isomorphism by induction. (Start the induction with Step 1!)

Step 3: Assertion (i) holds if V is finite dimensional.

We establish this by induction on $\dim V$, the case $\dim V = 1$ being Step 2. Write $V = U \oplus \mathbb{k}v$ so that $(\Lambda U, d)$ is a sub-Sullivan algebra and $dv \in \Lambda U$.

Thus $(\Lambda U, d) \rightarrow (\Lambda U \otimes \Lambda(v), d)$ is a relative Sullivan algebra. Since $(\Lambda V, d)$ is minimal, $d_0 = 0$. By induction on $\dim V$, $\zeta_* : \pi_*(|\Lambda U, d|) \rightarrow \text{Hom}(U, \mathbb{k})$ is an isomorphism. By Step 2, so is $\zeta_* : \pi_*(|\Lambda(v), 0|) \rightarrow \text{Hom}(\mathbb{k}v, \mathbb{k})$. Thus diagram 17.11 shows that $\partial_* = 0 : \pi_*(|\Lambda U, d|) \rightarrow \pi_{*-1}(|\Lambda(v), 0|)$.

Now (by naturality) we have the row exact commutative diagram

$$\begin{array}{ccccccc}
 0 & \rightarrow & \pi_*(|\Lambda(v), 0|) & \longrightarrow & \pi_*(|\Lambda V, d|) & \longrightarrow & \pi_*(|\Lambda U, d|) \rightarrow 0 \\
 & & \downarrow \zeta_* \cong & & \downarrow \zeta_* & & \downarrow \cong \zeta_* \\
 0 & \rightarrow & \text{Hom}(\mathbb{k}v, \mathbb{k}) & \longrightarrow & \text{Hom}(V, \mathbb{k}) & \longrightarrow & \text{Hom}(U, \mathbb{k}) \rightarrow 0
 \end{array}$$

and it follows that the central arrow is an isomorphism.

Step 4: Assertion (i) is true in general.

Fix n and let $U = V^{\leq n+1}$. Thus we have a fibration $|\Lambda V, d| \rightarrow |\Lambda U, d|$ with fibre $|\Lambda V^{>n+1}, \bar{d}|$. Since $(A_{PL})_r$ is concentrated in degrees $\leq r$ it follows that for $r \leq n+1$ the only morphism $(\Lambda V^{>n+1}, d) \rightarrow (A_{PL})_r$ is the augmentation $(\Lambda V^{>n+1}, d) \rightarrow \mathbb{k}$. Thus $|\Lambda V^{>n+1}, d|$ has a single zero cell, and no r -cells for $1 \leq r \leq n+1$.

It follows that $\pi_i(|\Lambda V^{>n+1}, d|) = 0$, $1 \leq r \leq n+1$, and hence $\pi_n(|\Lambda V, d|) \xrightarrow{\cong} \pi_n(|\Lambda U, d|)$. Moreover $U^n = V$ and $\theta_n : \pi_n(|\Lambda U, d|) \xrightarrow{\cong} \text{Hom}(U^n, \mathbb{k})$ is an isomorphism by Step 3. Hence $\theta_n : \pi_n(|\Lambda V, d|) \rightarrow \text{Hom}(V^n, \mathbb{k})$ is an isomorphism.

proof of (ii): It follows from (i) that $|\Lambda V, d|$ is simply connected and that each $\pi_n|\Lambda V, d|$ is a finite dimensional rational vector space, and that $\theta_* : \pi_*(|\Lambda V, d|) \xrightarrow{\cong} \text{Hom}_{\mathbb{Q}}(V, \mathbb{Q})$ is an isomorphism. We again proceed in stages.

Step 1: $V = V^n$.

Here $\pi_*(|\Lambda V, 0|)$ is concentrated in degree n and so $|\Lambda V, d|$ is an Eilenberg-MacLane space of type $K(\pi, n)$ with $\pi = \text{Hom}_{\mathbb{Q}}(V, \mathbb{Q})$. In particular, the Hurewicz homomorphism is an isomorphism, $hur : \pi_n(|\Lambda V, 0|) \xrightarrow{\cong} H_n(|\Lambda V, 0|; \mathbb{Z})$ by Theorem 4.19. It follows that $H_n(|\Lambda V, 0|; \mathbb{Z})$ is a rational vector space. Altogether then, since V is finite dimensional, we obtain

$$\begin{aligned}
 V &= \text{Hom}_{\mathbb{Q}}(\text{Hom}_{\mathbb{Q}}(V, \mathbb{Q}), \mathbb{Q}) \\
 &\cong \text{Hom}_{\mathbb{Z}}(H_n(|\Lambda V, 0|; \mathbb{Z}), \mathbb{Q}) \\
 &= H^n(|\Lambda V, 0|; \mathbb{Q}) .
 \end{aligned}$$

Back-checking through the definitions identifies this isomorphism as the linear map $H^n(m_{(\Lambda V, 0)}) : V^n \rightarrow H^n(A_{PL}(|\Lambda V, 0|))$. Now it follows from Example 2 of §15(b) that $m_{(\Lambda V, 0)} : (\Lambda V^n; 0) \rightarrow A_{PL}(|\Lambda V^n, 0|)$ is a quasi-isomorphism.

Step 2: $V = V^{\leq n}$.

Here we argue by induction on n , the case $n = 2$ being covered by Step 1. Put $U = V^{<n}$. The naturality of $\eta : (\Lambda V, d) \rightarrow A_{PL}(\langle \Lambda V, d \rangle)$ means that

$$\begin{array}{ccccc} (\Lambda V, d) & \longrightarrow & (\Lambda U \otimes \Lambda V^n, d) & \longrightarrow & (\Lambda V^n, 0) \\ \eta \downarrow & & \eta \downarrow & & \eta \downarrow \\ A_{PL}(\langle \Lambda U, d \rangle) & \longrightarrow & A_{PL}(\langle \Lambda V, d \rangle) & \longrightarrow & A_{PL}(\langle \Lambda V^n, 0 \rangle) \end{array}$$

commutes. Thus it is easy to arrange that

$$\begin{array}{ccccc} (\Lambda U, d) & \longrightarrow & (\Lambda U \otimes \Lambda V^n, d) & \longrightarrow & (\Lambda V^n, 0) \\ m_{(\Lambda U, d)} \downarrow & & m_{(\Lambda V, d)} \downarrow & & m_{(\Lambda V^n, 0)} \downarrow \\ A_{PL}(|\Lambda U, d|) & \longrightarrow & A_{PL}(|\Lambda V, d|) & \longrightarrow & A_{PL}(|\Lambda V^n, 0|) \end{array}$$

commutes as well.

In this diagram $m_{(\Lambda U, d)}$ is a quasi-isomorphism (induction on n) as is $m_{(\Lambda V^n, 0)}$ (Step 1). Thus Proposition 15.6 gives a quasi-isomorphism

$$m : (\Lambda U \otimes \Lambda V^n, D) \xrightarrow{\cong} A_{PL}(|\Lambda V, d|)$$

which extends $m_{(\Lambda U, d)}$ and induces $m_{(\Lambda V^n, 0)}$. By the Lifting lemma 14.4 we can extend the identity of $(\Lambda U, d)$ to a morphism $\varphi : (\Lambda U \otimes \Lambda V^n, d) \rightarrow (\Lambda U \otimes \Lambda V^n, D)$ such that $m\varphi \sim m_{(\Lambda V, d)} \text{ rel } (\Lambda U, d)$. Then $(\varphi - id) : V^n \rightarrow \Lambda U$, which implies that φ is an isomorphism and $m_{(\Lambda V, d)}$ is a quasi-isomorphism.

Step 3: The general case.

For the general case we fix any n and show that $H^n(m_{\Lambda V, d})$ is an isomorphism. As observed in Step 4 of (i), $|\Lambda V^{>n+1}, d|$ is $(n+1)$ -connected. Thus it has a Sullivan model of the form $(\Lambda W^{>n+1}, d)$, while $|\Lambda V^{\leq n+1}, d|$ has $(\Lambda V^{\leq n+1}, d)$ as its Sullivan model. By Proposition 15.6, $|\Lambda V, d|$ has a Sullivan model of the form $(\Lambda V^{\leq n+1} \otimes \Lambda W^{>n+1}, D)$ and hence $H^n(|\Lambda V^{\leq n+1}, d|; \mathbb{Q}) \xrightarrow{\cong} H^n(|\Lambda V, d|; \mathbb{Q})$. This identifies $H^n(m_{(\Lambda V, d)})$ with $H^n(m_{(\Lambda V^{\leq n+1}, d)})$, which is an isomorphism by Step 2. □

When $\mathbb{k} = \mathbb{Q}$ and $(\Lambda V, d)$ is a Sullivan algebra satisfying the hypotheses of Theorem 17.10 then the quasi-isomorphism

$$m_{(\Lambda V, d)} : (\Lambda V, d) \xrightarrow{\cong} A_{PL}(|\Lambda V, d|)$$

is called a *canonical Sullivan model*.

Now let X be any simply connected CW complex with rational homology of finite type, and let

$$m_X : (\Lambda W, d) \xrightarrow{\cong} A_{PL}(X)$$

be a minimal Sullivan model. Since $A_{PL}(X) = A_{PL}(S_*(X))$, the adjointness formula (17.8) produces a natural simplicial map

$$\gamma_X : S_*(X) \longrightarrow \langle \Lambda W, d \rangle ,$$

adjoint to m_X . On the other hand in Proposition 17.3 we established a natural homotopy equivalence $s_X : |S_*(X)| \longrightarrow X$. Let t_X be the inverse homotopy equivalence (defined uniquely up to homotopy) and set

$$h_X = |\gamma_X| \circ t_X : X \longrightarrow |\Lambda W, d| .$$

Theorem 17.12 *With the notation and hypotheses above,*

(i) *The diagram*

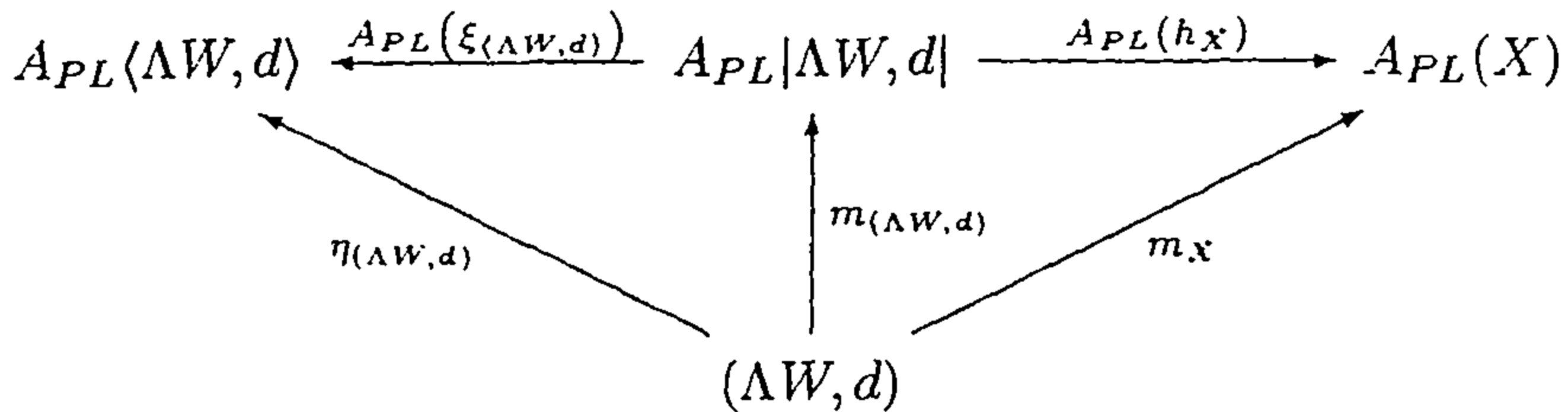

is homotopy commutative.

(ii) *If $\mathbb{k} = \mathbb{Q}$ then all the morphisms in the diagram are quasi-isomorphisms. In particular, h_X is a rationalization of X (§9(b)).*

proof: (i) The left hand triangle commutes by construction. Next observe that $S_*(s_X) \circ \xi_{S_*(X)} = id : S_*(X) \longrightarrow S_*(X)$. Since $t_X s_X \sim id_{|S_X|}$ we can apply Proposition 12.6 to conclude that

$$\begin{aligned}
 A_{PL}(\xi_{S_*(X)}) \circ \varphi & \sim A_{PL}(\xi_{S_*(X)}) \circ A_{PL}(s_X) \circ A_{PL}(t_X) \circ \varphi \\
 & = A_{PL}(t_X) \circ \varphi
 \end{aligned}$$

for any morphism $\varphi : (\Lambda W, d) \longrightarrow A_{PL}(|S_*(X)|)$. Thus

$$\begin{aligned}
 A_{PL}(h_X) \circ m_{\langle \Lambda W, d \rangle} & \sim A_{PL}(\xi_{S_*(X)}) \circ A_{PL}(|\gamma_X|) \circ m_{\langle \Lambda W, d \rangle} \\
 & = A_{PL}(\gamma_X) \circ A_{PL}(\xi_{\langle \Lambda W, d \rangle}) \circ m_{\langle \Lambda W, d \rangle} \\
 & = A_{PL}(\gamma_X) \circ \eta_{\langle \Lambda W, d \rangle} \\
 & = m_X ,
 \end{aligned}$$

the last equality following from the adjointness of γ_X and m_X .

(ii) According to Theorem 17.10, $m_{\langle \Lambda W, d \rangle}$ is a quasi-isomorphism. Hence so is $A_{PL}(h_X)$. In §17(a) we observed that $C_*(\xi_K)$ is a quasi-isomorphism for

any simplicial set K . In particular $A_{PL}(\xi_{(\Lambda W, d)})$ is a quasi-isomorphism. Hence so is $\eta_{(\Lambda W, d)}$.

Finally since $|\Lambda W, d|$ is a simply connected rational space and since $H_*(h_X; \mathbb{Q})$ is an isomorphism (because $A_{PL}(h_X)$ is a quasi-isomorphism) it follows that h_X is a rationalization (Theorem 9.6). \square

(e) Morphisms and continuous maps.

In §12(c) we observed that homotopic continuous maps $f_0 \sim f_1 : X \rightarrow Y$ have homotopic Sullivan representatives. In the reverse direction we prove

Proposition 17.13 *If $\varphi_0 \sim \varphi_1 : (\Lambda V, d) \rightarrow (\Lambda W, d)$ are homotopic morphisms between Sullivan algebras then*

$$|\varphi_0| \sim |\varphi_1| : |\Lambda W, d| \rightarrow |\Lambda V, d| .$$

proof: A homotopy from φ_0 to φ_1 is a morphism $\Phi : (\Lambda V, d) \rightarrow (\Lambda W, d) \otimes \Lambda(t, dt)$ such that $(id \otimes \varepsilon_i)\Phi = \varphi_i$, where $\varepsilon_i(t) = i$. Since realization preserves products (the Example of §17(c)) we obtain a continuous map $|\Phi| : |\Lambda W, d| \times |\Lambda(t, dt)| \rightarrow |\Lambda V, d|$ such $|\Phi|(x, \varepsilon_i) = |\varphi_i|(x)$. But the identity map of $\Lambda(t, dt)$ is a 1-cell in $|\Lambda(t, dt)|$ joining ε_0 to ε_1 , and so $|\varphi_0| \sim |\varphi_1|$. \square

Now suppose $\varphi : (\Lambda V, d) \rightarrow (\Lambda W, d)$ is a morphism of Sullivan algebras. By adjointness — cf. (17.8) —

$$A_{PL}(\langle \varphi \rangle) \circ \mu = \mu \circ \varphi : (\Lambda V, d) \rightarrow A_{PL}(\langle \Lambda W, d \rangle) ,$$

where μ continues to denote the adjoints of $id_{(\Lambda V, d)}$ and $id_{(\Lambda W, d)}$. It follows that

$$\begin{array}{ccc}
 (\Lambda V, d) & \xrightarrow{\varphi} & (\Lambda W, d) \\
 m_{(\Lambda V, d)} \downarrow & & \downarrow m_{(\Lambda W, d)} \\
 A_{PL}(|\Lambda V, d|) & \xrightarrow{A_{PL}(|\varphi|)} & A_{PL}(|\Lambda W, d|)
 \end{array} \tag{17.14}$$

is homotopy commutative. Thus if φ is a morphism of simply connected rational minimal Sullivan algebras of finite type then (17.14) exhibits φ as a Sullivan representative of $|\varphi|$.

Next, suppose $f : X \rightarrow Y$ is a continuous map between simply connected CW complexes with rational homology of finite type. Let $m_X : (\Lambda W, d) \rightarrow A_{PL}(X)$ and $m_Y : (\Lambda V, d) \rightarrow A_{PL}(Y)$ be minimal rational Sullivan models, and recall the continuous maps h_X and h_Y defined at the end of §17(d).

Theorem 17.15 *With the hypothesis and notation above, let $\varphi : (\Lambda V, d) \rightarrow (\Lambda W, d)$ be a Sullivan representative for f . Then the diagram*

$$\begin{array}{ccc}
 X & \xrightarrow{f} & Y \\
 \downarrow h_X & & \downarrow h_Y \\
 |\Lambda W, d| & \xrightarrow{|\varphi|} & |\Lambda V, d|
 \end{array}$$

is homotopy commutative.

proof: In the notation at the end of §17(d), t_X and t_Y are homotopy inverses to s_X and s_Y . Since $f s_X = s_Y |S_*(f)|$ it follows that $t_Y f \sim |S_*(f)| t_X$. But $h_X = |\gamma_X| \circ t_X$, and so it is sufficient to prove that $|\gamma_Y| \circ |S_*(f)| \sim |\varphi| \circ |\gamma_X|$.

Because φ is a Sullivan representative of f there is a cochain algebra morphism $\Psi : (\Lambda V, d) \rightarrow A_{PL}(X) \otimes \Lambda(t, dt)$ such that $(id \otimes \varepsilon_0)\Psi = A_{PL}(f)m_Y$ and $(id \otimes \varepsilon_1)\Psi = m_X \varphi$. Compose this with the obvious morphism $A_{PL}(X) \otimes \Lambda(t, dt) \rightarrow A_{PL}(S_*(X) \times \Delta[1])$ and take the adjoint morphism $\omega : S_*(X) \times \Delta[1] \rightarrow \langle \Lambda V, d \rangle$ via the adjoint relation (7.8). Then $|\omega| : |\gamma_Y S_*(f)| \sim |\varphi \gamma_X|$. \square

(f) Integration, chain complexes and products.

Suppose given a Sullivan algebra $(\Lambda V, d)$ and recall the natural morphisms of cochain complexes

$$(\Lambda V, d) \xrightarrow{\eta} A_{PL} \langle \Lambda V, d \rangle \xrightarrow{\oint} C^* \langle \Lambda V, d \rangle$$

defined respectively in §17(c) and in §10(e). We denote by $C_{(\Lambda V, d)}$ the chain complex $\text{Hom}(\Lambda V, \mathbb{k})$. Then the composite $\oint \circ \eta$ dualizes to a natural morphism of chain complexes,

$$\int_* : C_* \langle \Lambda V, d \rangle \rightarrow C_{(\Lambda V, d)},$$

(since $C_* \langle \Lambda V, d \rangle$ includes naturally in $\text{Hom}(C^* \langle \Lambda V, d \rangle, \mathbb{k})$ via the obvious pairing).

Proposition 17.16 *Suppose $(\Lambda V, d)$ is a Sullivan algebra in which each V^n is finite dimensional and either $V = V^{\geq 2}$ or else d preserves V . Then \int_* is a quasi-isomorphism.*

proof: Theorem 10.15(ii) asserts that \oint is a quasi-isomorphism. On the other hand, so is any canonical Sullivan model, $m_{(\Lambda V, d)}$. (If $V = V^{\geq 2}$ this is Theorem 17.10. If $d : V \rightarrow V$ a trivial modification of the proof gives the same result.) Since $\eta = A_{PL}(\xi) \circ m_{(\Lambda V, d)}$ it follows that η is a quasi-isomorphism too (§17(d)). Thus the composite dualizes to a quasi-isomorphism $\text{Hom}(C^* \langle \Lambda V, d \rangle, \mathbb{k}) \xrightarrow{\cong} C_{(\Lambda V, d)}$.

Finally, if C is any chain complex there is a natural morphism $C \rightarrow \text{Hom}(\text{Hom}(C, \mathbb{k}), \mathbb{k})$. If C itself has finite type this is an isomorphism. If $H(C)$ has finite type then this is a quasi-isomorphism because $H(\text{Hom}(-, \mathbb{k})) = \text{Hom}(H(-), \mathbb{k})$. In the case of $(\Lambda V, d)$ we have $H^*(\Lambda V, d) \cong H(\Lambda V, d)$ and so $H_*(\Lambda V, d)$ has finite type. Thus since $C^*(\Lambda V, d) = \text{Hom}(C_*(\Lambda V, d), \mathbb{k})$ the inclusion $\lambda : C_*(\Lambda V, d) \rightarrow \text{Hom}(C^*(\Lambda V, d), \mathbb{k})$ is a quasi-isomorphism too. Hence so is the composite $\int_* = \text{Hom}(\phi \circ \eta, \mathbb{k}) \circ \lambda$. \square

The quasi-isomorphisms $\phi_K : A_{PL}(K) \rightarrow C^*(K)$ are not a morphisms of cochain algebras. In compensation, we show that the quasi-isomorphism \int_* is ‘compatible’ with geometric products.

For this we recall the definition (§17(b)) of the product $K \times L = \{K_n \times L_n, \partial_i \times \partial_i, s_j \times s_j\}$ of simplicial sets. The simplicial diagonal $\Delta_K : K \rightarrow K \times K$ is the morphism $\sigma \mapsto (\sigma, \sigma)$. Now in §17(a) we introduced the dgc, $C_*(K)$ and identified it as a sub dgc of $C_*(|K|)$ via the inclusion $C_*(\xi_K)$. In this setting, the Eilenberg-Zilber and Alexander-Whitney morphisms restrict to morphisms

$$C_*(K) \otimes C_*(L) \xrightarrow{EZ} C_*(K \times L) \xrightarrow{AW} C_*(K) \otimes C_*(L)$$

and the comultiplication in $C_*(K)$ is just $AW \circ C_*(\Delta_K)$. Clearly $AW \circ EZ = id$ and tedious but straightforward computations show, as in Proposition 4.10 that $EZ \circ AW \sim id$.

Now suppose $(\Lambda V, d)$ and $(\Lambda W, d)$ are Sullivan algebras. A natural inclusion $C_{(\Lambda V, d)} \otimes C_{(\Lambda W, d)} \rightarrow C_{(\Lambda V, d) \otimes (\Lambda W, d)}$ is given by

$$(a \otimes b)(\Phi \otimes \Psi) = (-1)^{\deg b \deg \Phi} a(\Phi)b(\Psi), \quad a \in C_{(\Lambda V, d)},$$

$b \in C_{(\Lambda W, d)}$; moreover this inclusion is an isomorphism if either ΛV or ΛW has finite type. Recall also from the Example of §17(c) that we identify $((\Lambda V, d) \otimes (\Lambda W, d)) = (\Lambda V, d) \times (\Lambda W, d)$.

Proposition 17.17 *If $(\Lambda V, d)$ and $(\Lambda W, d)$ are Sullivan algebras then the diagram*

$$\begin{array}{ccc} C_*(\Lambda V, d) \otimes C_*(\Lambda W, d) & \xrightarrow{EZ} & C_*((\Lambda V, d) \otimes (\Lambda W, d)) \\ \int_* \otimes \int_* \downarrow & & \downarrow \int_* \\ C_{(\Lambda V, d)} \otimes C_{(\Lambda W, d)} & \xrightarrow{\quad} & C_{(\Lambda V, d) \otimes (\Lambda W, d)} \end{array}$$

commutes.

proof: First consider arbitrary simplicial sets K and L and let $p_K : K \times L \rightarrow K$ and $p_L : K \times L \rightarrow L$ be the projections. If $\Phi \in A_{PL}(K)$ and $\Psi \in A_{PL}(L)$ we abbreviate $A_{PL}(p_K)\Phi \wedge A_{PL}(p_L)\Psi$ to $\Phi \times \Psi$. We begin by showing by induction on $p + q$ that:

- For any $\Phi \in A_{PL}^p(K)$, $\Psi \in A_{PL}^q(L)$, $\sigma \in K_k$ and $\tau \in L_\ell$,

$$\left(\int_{K \times L} \Phi \times \Psi \right) (EZ(\sigma \otimes \tau)) = \begin{cases} (-1)^{pq} \left(\int_K \Phi \right) (\sigma) \cdot \left(\int_L \Psi \right) (\tau) & , p = k, q = \ell, \\ 0 & , \text{otherwise.} \end{cases} \tag{17.18}$$

Indeed, if $p + q = 0$ then σ and τ are vertices, $EZ(\sigma \otimes \tau) = (\sigma, \tau)$ and the left hand side is just $\Phi(\sigma)\Psi(\tau)$. This is (trivially) the same as the right hand side. Suppose $p + q = n$ and that the proposition is proved for $n - 1$. Recall from §10(a) that σ and τ determine simplicial maps $\sigma_* : \Delta[p] \rightarrow K$ and $\tau_* : \Delta[q] \rightarrow L$. By naturality we may use these to reduce to the case $K = \Delta[p]$, $L = \Delta[q]$. Thus $A_{PL}(K) = (A_{PL})_p$ and $A_{PL}(L) = (A_{PL})_q$, as observed in Proposition 10.4(i). In particular there are polynomials $f(t_1, \dots, t_p)$ and $g(t_1, \dots, t_q)$ such that $\Phi = f dt_1 \wedge \dots \wedge dt_p$ and $\Psi = g dt_1 \wedge \dots \wedge dt_q$.

Now either $p > 0$ or $q > 0$. In either case $d\Phi = d\Psi = 0$. If $p > 0$ clearly $\Phi = d\Gamma$ and $\Phi \times \Psi = d(\Gamma \times \Psi)$, some $\Gamma \in (A_{PL})_p^{p-1}$. Since $\int_{K \times L}$ commutes with the differentials, for any $c \in C_n(K \times L)$ we have

$$\left(\int_{K \times L} d(\Gamma \times \Psi) \right) (c) = \left(d \int_{K \times L} (\Gamma \times \Psi) \right) (c) = (-1)^{p+q-1} \left(\int_{K \times L} \Gamma \times \Psi \right) (dc).$$

Since EZ also commutes with differentials we may substitute $EZ(\sigma \otimes \tau)$ for c and use induction to complete the proof. If $p = 0$ and $q > 0$ write $\Psi = d\Omega$ and use the same argument. (A second proof may be constructed starting from the observation $\iint_{X \times Y} f(t)g(s)dt ds = \left(\int_X f(t)dt \right) \left(\int_Y g(s)ds \right)$. This idea, while more intuitive, is technically more complicated to implement.)

Now specialize to the case $K = \langle \Lambda V, d \rangle$ and $L = \langle \Lambda W, d \rangle$, and observe that

$$\eta_{(\Lambda V, d) \otimes (\Lambda W, d)}(\Phi \otimes \Psi) = \eta_{(\Lambda V, d)}\Phi \times \eta_{(\Lambda W, d)}\Psi, \quad \begin{matrix} \Phi \in \Lambda V, \\ \Psi \in \Lambda W. \end{matrix}$$

Thus for $\sigma \in K, \tau \in L$,

$$\begin{aligned} \left(\int_* EZ(\sigma \otimes \tau) \right) (\Phi \otimes \Psi) &= \pm \langle \int_{K \times L} (\eta_{(\Lambda V, d)}\Phi \times \eta_{(\Lambda W, d)}\Psi), EZ(\sigma \otimes \tau) \rangle \\ &= \pm \langle \int_K \eta_{(\Lambda V, d)}\Phi, \sigma \rangle \langle \int_L \eta_{(\Lambda W, d)}\Psi, \tau \rangle \\ &= \left(\int_* \sigma \otimes \int_* \tau \right) (\Phi \otimes \Psi). \end{aligned}$$

□

Exercises

1. Let $(\Lambda V, d)$ be a Sullivan minimal model with $\dim H^*(\Lambda V, d) < \infty$ and $V^1 = 0$. Show that $(\Lambda V, d)$ is the Sullivan minimal model of a 1-connected finite CW complex.

2. Prove that the geometric realization of the relative Sullivan model $(\wedge x_2 \otimes \wedge x_3; dx_3 = x_2^2)$ is the rationalization of the principal fibration $S^3 \rightarrow S^2 \rightarrow K(\mathbb{Z}, 2)$.
3. Let $(\wedge(x_3, x_5), 0) \otimes (\wedge(v_3, v'_3, v_5, v_7, v'_7, u_9, v_9, w_9, \dots), d)$ be the Sullivan minimal model of the product $(S^3 \times S^5) \times (S^3 \vee S^3)$. Compute the differential d for the given generators. Consider the relative Sullivan model $(\wedge(x_3, y_5) \otimes \wedge(v_3, v'_3, v_5, v_7, v'_7, u_9, v_9, w_9, \dots), D)$ with $D = d$ up to degree 8, $Du_9 = du_9$, $Dv_9 = dv_9$ and $Dw_9 = dw_9 + x_5v_5, \dots$. Prove that the geometric realization of this model is rationally equivalent to the total space of a fibration $(S^3 \vee S^3) \rightarrow E \rightarrow (S^3 \times S^5)$ with non trivial connecting morphism. If a and b are generators of $\pi_3(S^3 \vee S^3)$ compute $[[a, b]_W a]_W$.
4. Prove that if $\varphi : (A, d_A) \rightarrow (B, d_B)$ is a quasi-isomorphism then $H^*(|\varphi|) : H^*(|A, d_A|) \rightarrow H^*(|B, d_B|)$ is an isomorphism.
5. Let $\varphi : (\wedge t, 0) \rightarrow \wedge(x, y, z)$ be as in §3-exercise 3. Is $|\varphi|$ an homotopy equivalence?
6. Let $(\wedge V, d)$ be a Sullivan minimal model and x an element of degree n . Prove that $[(\wedge x, 0), (\wedge V, d)] = H^n(\wedge V, d)$. Deduce that if X is a space then $[X, K(\mathbb{Q}, n)] = H^n(X; \mathbb{Q})$.

Part III

Graded Differential Algebra (continued)

18 Spectral sequences

The ground ring in this section is an arbitrary commutative ring \mathbf{k} , except in topic (d) where \mathbf{k} is a field.

Although we have managed to provide the reader with relatively simple ‘spectral sequence-free’ proofs in Parts I and II, subsequent material necessarily uses spectral sequences in a fundamental way. We therefore introduce them here, but limit ourselves to the strict minimum that will be required. In particular, we consider only the spectral sequence of a filtered object, and even there make no attempt to present results in their most general form.

A *spectral sequence* is, in particular, a sequence of differential graded modules (E^i, d^i) such that $H(E^i) \cong E^{i+1}$. They can be used to ‘approximate’ the homology of a complicated differential module and in this (and other), contexts play an essential role in homological calculations.

In this section we provide a brief and elementary introduction, including only material that will be required in the following sections. In particular, much of what is presented here holds in considerably greater generality.

This section is divided into the following topics.

- (a) Bigraded modules and spectral sequences.
- (b) Filtered differential modules.
- (c) Convergence.
- (d) Tensor products and extra structure.

(a) Bigraded modules and spectral sequences.

Recall (§3) that a graded module M is a family $\{M_i\}_{i \in \mathbb{Z}}$ of modules. Analogously a *bigraded module* is a family $M = \{M_{i,j}\}_{(i,j) \in \mathbb{Z} \times \mathbb{Z}}$ of modules indexed by pairs of integers (i, j) . The basic constructions of §3 (e.g. Hom and \otimes) carry over verbatim to the bigraded case. In particular a linear map $f : M \rightarrow N$ of bidegree (p, q) is a family of linear maps $f : M_{i,j} \rightarrow N_{i+p, j+q}$ and a *differential* is a linear map $d : M \rightarrow M$ such that $d^2 = 0$ and d has bidegree $(-i, i - 1)$ for some i . The homology, $H(M) = \ker d / \text{Im } d$, is again a bigraded module.

Associated with a bigraded module M is the graded module $\text{Tot}(M)$ defined by

$$\text{Tot}(M)_k = \bigoplus_{i+j=k} M_{i,j}$$

and a differential in M induces an ordinary differential in $\text{Tot}(M)$.

Finally, as in the singly graded case, we raise and lower indices by setting

$$M^{i,j} = M_{-i, -j}.$$

We can now define spectral sequences.

Definition A homology spectral sequence starting at E^s is a sequence

$$(E^r, d^r, \sigma^r)_{r \geq s}$$

in which $E^r = \{E_{p,q}^r\}$ is a bigraded module, d^r is a differential in E^r of bidegree $(-r, r - 1)$ and $\sigma^r : H(E^r) \xrightarrow{\cong} E^{r+1}$ is an isomorphism of bigraded modules.

A cohomology spectral sequence is a sequence (E_r, d_r, σ_r) , $r \geq s$, with $E_r = \{E_r^{p,q}\}$, d_r a differential of bidegree $(r, -r + 1)$ and $\sigma_r : H(E_r) \xrightarrow{\cong} E_{r+1}$. Thus raising degrees converts a homology spectral sequence into a cohomology spectral sequence.

We shall frequently suppress the σ_r from the notation and refer to the spectral sequence (E^r, d^r) or (E_r, d_r) .

In calculating with (cohomology) spectral sequences it is frequently useful to represent them by diagrams of the form

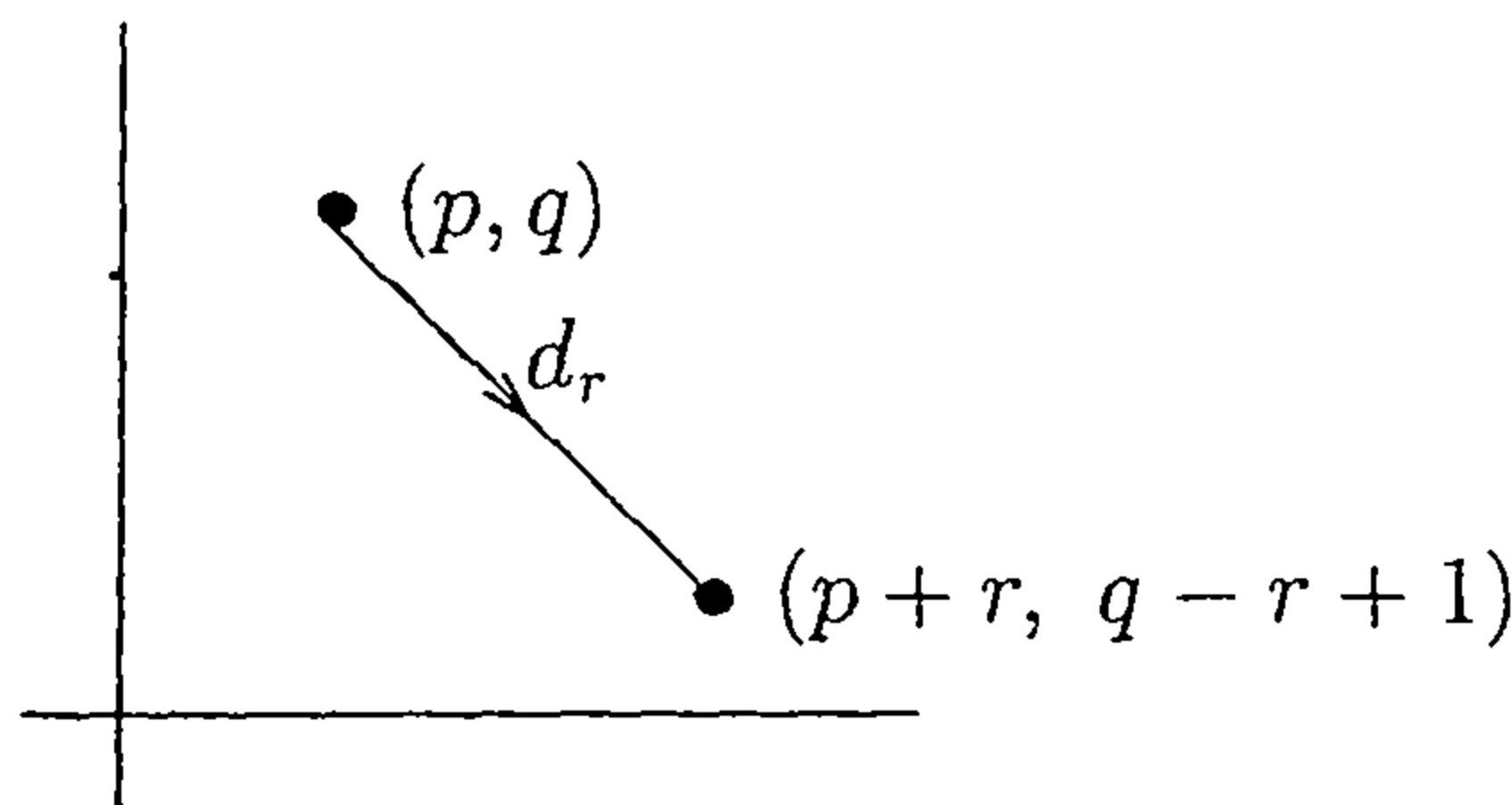

A morphism of spectral sequences is a sequence of linear maps $\varphi^{(r)} : E^{(r)} \rightarrow \hat{E}^{(r)}$ of bidegree zero, commuting with the differentials, and such that σ^r identifies $H(\varphi^{(r)})$ with $\varphi^{(r+1)}$, (or $\varphi_{(r)} : E_{(r)} \rightarrow \hat{E}_{(r)}$ such that σ_r identifies $H(\varphi_{(r)})$ with $\varphi_{(r+1)}$).

(b) Filtered differential modules.

A filtered (graded) module is a graded module, M , together with an increasing sequence

$$\mathfrak{F} : \dots \subset F_p \subset F_{p+1} \subset \dots \quad , p \in \mathbb{Z}$$

of submodules, called the filtration of M . (If $M = \{M^n\}$ we write $F^p = F_{-p}$ and so the filtration has the form

$$\mathfrak{F} : \dots \supset F^p \supset F^{p+1} \supset \dots .)$$

We may also write $F^p M$ instead of F^p if necessary to avoid confusion. The filtered module (M, \mathfrak{F}) determines the associated bigraded module, $\mathcal{G}M$, given by

$$\mathcal{G}_{p,q}(M) = (F_p / F_{p-1})_{p+q} \quad \text{or} \quad \mathcal{G}^{p,q}(M) = (F^p / F^{p+1})^{p+q} ,$$

Here p is called the *filtration degree* and q is the *complementary degree*.

A linear map $\varphi : M \rightarrow N$ between filtered modules is *filtration preserving* if it sends each $F_p(M)$ to $F_p(N)$. In this case it induces $\mathcal{G}\varphi : \mathcal{G}M \rightarrow \mathcal{G}N$ in the obvious way. A *filtered differential module* (M, d, \mathfrak{F}) is a filtered module (M, \mathfrak{F}) together with a filtration-preserving differential in M .

Example 1 *Semifree modules.*

Suppose (M, d) is a semifree (R, d) -module. Then (by definition, cf. §6) M admits a filtration

$$0 \subset M(0) \subset M(1) \subset \dots$$

such that

$$(\mathcal{G}M, \mathcal{G}d) \cong (R, d) \otimes (V, 0) .$$

□

Example 2 *Relative Sullivan algebras.*

Let $(B \otimes \Lambda V, d)$ be a relative Sullivan algebra (§14). It is *filtered by the degree of B* :

$$F^p(B \otimes \Lambda V) = B^{\geq p} \otimes \Lambda V, \quad p = 0, 1, 2, \dots$$

and the associated bigraded module is given by

$$(\mathcal{G}(B \otimes \Lambda V), \mathcal{G}d) = (B, 0) \otimes (\Lambda V, \bar{d}) .$$

□

Example 3 *The word-length filtration of a Sullivan algebra.*

Filter a Sullivan algebra $(\Lambda V, d)$ by its *word-length* (cf. §12):

$$F^p(\Lambda V) = \Lambda^{\geq p} V, \quad p \geq 0 .$$

The associated bigraded module is then given by

$$(\mathcal{G}(\Lambda V), \mathcal{G}d) = (\Lambda V, d_0) ,$$

where d_0 is the linear part of $d : d_0 : V \rightarrow V$ and $d - d_0 : V \rightarrow \Lambda^{\geq 2} V$. □

Suppose (M, d, \mathfrak{F}) is a filtered (graded) differential module. Then $(\mathcal{G}M, \mathcal{G}d)$ is a differential bigraded module in which $\mathcal{G}d$ is a ‘first approximation’ to d . The *spectral sequence associated with (M, d, \mathfrak{F})* is a spectral sequence beginning with $(\mathcal{G}M, \mathcal{G}d)$ and, as we shall see in (c), ‘converging’ in many cases to $H(M, d)$. We shall define the cohomology spectral sequence for $M = \{M^i\}_{i \in \mathbb{Z}}$; the homology spectral sequence for $M = \{M_i\}_{i \in \mathbb{Z}}$ is obtained simply by lowering indices.

To begin, denote the filtration of M by $\dots \supset F^p \supset F^{p+1} \supset \dots$. Note that each F^p is a graded module: $F^p = \{(F^p)^n\}_{n \in \mathbb{Z}}$. For each integer $r \geq 0$ define graded modules Z_r^p and D_r^p by

$$Z_r^p = \{x \in F^p \mid dx \in F^{p+r}\} \quad \text{and} \quad D_r^p = F^p \cap dF^{p-r} .$$

Evidently

$$D_0^p \subset D_1^p \subset \cdots \subset D_r^p \subset \cdots \subset Z_r^p \subset \cdots \subset Z_1^p \subset Z_0^p .$$

Now define bigraded modules E_r , $r \geq 0$, by letting $E_r^{p,q}$ be the component of $Z_r^p / (Z_{r-1}^{p+1} + D_{r-1}^p)$ in degree $p + q$:

$$E_r^{p,q} = \left(Z_r^p / \left(Z_{r-1}^{p+1} + D_{r-1}^p \right) \right)^{p+q} .$$

It is immediate from the definition that d factors to define a differential d_r in E_r of bidegree $(r, 1-r)$. Moreover, the inclusions $Z_{r+1}^p \hookrightarrow Z_r^p$ induce isomorphisms of bigraded modules

$$E_{r+1} \xrightarrow{\cong} H(E_r, d_r) .$$

Note as well that

$$(E_0, d_0) = (\mathcal{G}M, \mathcal{G}d) .$$

Definition The spectral sequence (E_r, d_r) is called *the spectral sequence of the filtered differential module (M, d, \mathfrak{F})* .

Note that this construction is *natural*: if φ is a morphism of filtered differential modules it induces a unique morphism $E_r(\varphi)$ of spectral sequences such that $E_0(\varphi) = \mathcal{G}\varphi$.

Example 4 *Bigradations.*

There is one particular situation that arises frequently in practice. We suppose given a graded differential module (M, D) in which

- Each M^r is given as a direct sum $M^r = \bigoplus_{p+q=r} M^{p,q}$,
- The differential d is a direct sum $D = \sum_{i \geq 0} D_i$ with $D_i : M^{p,q} \rightarrow M^{p+i, q-i+1}$.

Here a canonical filtration is given by $F^k(M)^r = \bigoplus_{p \geq k} M^{p, r-p}$ and this leads as just described to a spectral sequence.

Moreover from $D^2 = 0$ we deduce $D_0^2 = 0$, $D_1 D_0 + D_0 D_1 = 0$ and $D_1^2 = -D_0 D_2 + D_2 D_0$. In particular, D_0 is itself a differential and D_1 induces a differential $H(D_1)$ in $H(M, D_0)$. Now a straightforward verification shows that the first two terms of the spectral sequence are given by

$$(E_0, d_0) = (M, D_0) \quad \text{and} \quad (E_1, d_1) = (H(M, D_0), H(D_1)) . \quad \square$$

(c) Convergence.

Suppose (E_r, d_r) is a cohomology spectral sequence. Fix a pair (p, q) . If the maps

$$E_r^{p-r, q+r-1} \xrightarrow{d_r} E_r^{p, q} \xrightarrow{d_r} E_r^{p+r, q-r+1}$$

are both zero then $H^{p,q}(E_r, d_r) = E_r^{p,q}$ and $\sigma_r : E_r^{p,q} \xrightarrow{\cong} E_{r+1}^{p,q}$. In this case we write $E_r^{p,q} = E_{r+1}^{p,q}$. The spectral sequence (E_r, d_r) is called *convergent* if for each (p, q) there is an integer $r(p, q)$ such that

$$E_{r(p,q)}^{p,q} = E_{r(p,q)+1}^{p,q} = \cdots = E_r^{p,q} = \cdots, \quad r \geq r(p, q).$$

In this case the bigraded module $E_\infty^{p,q}$ is defined by $E_\infty^{p,q} = E_r^{p,q}$, $r \geq r(p, q)$. The spectral sequence *collapses at E_r* if $d_i = 0$, $i \geq r$. In this case E_∞ is defined and $E_r = E_\infty$.

An important example of convergence arises in the case of first quadrant spectral sequences, which we now define.

A *first quadrant* cohomology spectral sequence is one in which each $E_r = \{E_r^{p,q}\}_{p \geq 0, q \geq 0}$. These spectral sequences are convergent with $E_\infty^{p,q} = E_r^{p,q}$, $r > \max(p, q + 1)$. Analogously, a *first quadrant (cohomology) filtration* in a graded module M is a filtration $\{F^p M\}$ such that

$$F^0 M = M \quad \text{and} \quad F^p M = \{(F^p M)^n\}_{n \geq p}.$$

Notice that these conditions imply that $M = \{M^n\}_{n \geq 0}$.

Let (M, d, \mathfrak{F}) be a filtered differential (graded) module. Define a filtration in $H(M)$ by

$$F^p(H(M)) = \text{Im}(H(F^p M) \rightarrow H(M)).$$

If the associated spectral sequence is convergent and if there is a natural isomorphism $E_\infty \cong \mathcal{G}H(M)$ then we say *the spectral sequence is convergent to $H(M)$* .

Proposition 18.1 *Suppose (M, d, \mathfrak{F}) is a cochain complex with a first quadrant filtration. Then the associated spectral sequence is first quadrant, and converges to $H(M)$.*

proof: The first assertion is immediate since $E_0 = \mathcal{G}M$ is necessarily concentrated in non-negative bidegrees.

For the second assertion let $Z_r^{p,q}$ be the component of degree $p + q$ in the graded module Z_r^p . If $r > q + 1$ then

$$d : Z_r^{p,q} \rightarrow (F^{p+r} M)^{p+q+1} = 0.$$

Thus

$$Z_r^{p,q} = \ker d \cap (F^p M)^{p+q} \quad \text{and, similarly,} \quad Z_{r-1}^{p+1, q-1} = \ker d \cap (F^{p+1} M)^{p+q}.$$

Moreover, if $r > p$ then $D_{r-1}^p = d(M) \cap F^p M$. This identifies

$$E_r^{p,q} = Z_r^{p,q} / \left(Z_{r-1}^{p+1, q-1} + (D_{r-1}^p)^{p+q} \right) \cong \mathcal{G}^{p,q} H(M). \quad \square$$

Proposition 18.2 (*Comparison*) *Let $\varphi : (M, d, \mathfrak{F}) \rightarrow (N, d, \mathfrak{F})$ be a morphism of filtered cochain complexes with first quadrant filtrations. If some $E_r(\varphi)$ is a quasi-isomorphism then $H(\varphi)$ is an isomorphism of filtered modules. In particular, φ is a quasi-isomorphism.*

Lemma 18.3 *Suppose $\psi : (M, \mathfrak{F}) \rightarrow (N, \mathfrak{F})$ is a morphism of filtered graded modules with first quadrant (cohomology) filtrations. If $\mathcal{G}(\psi)$ is injective (resp. surjective) then so is ψ .*

proof: Suppose $\mathcal{G}(\psi)$ is injective. If $0 \neq x \in M^n$ there is a greatest p such that $x \in F^p M$, because $(F^{n+1} M)^n = 0$. Thus x represents a non-zero element $[x] \in \mathcal{G}^{p, n-p}(M)$ and so $0 \neq \mathcal{G}(\psi)[x] = [\psi x]$. In particular $\psi x \neq 0$.

Suppose $\mathcal{G}(\psi)$ is surjective. Then for each p , $\psi(F^p M) + F^{p+1} N = F^p N$. It follows by induction on q that $\psi(F^p M) + F^{p+q} N = F^p N$, $q \geq 0$. Fix n and choose q so $p+q > n$. Then $(F^{p+q} N)^n = 0$. It follows that $\psi(F^p M) = F^p N$. \square

proof of 18.2: Since $E_{i+1}(\varphi)$ is identified with $H(E_i(\varphi))$ it follows that $E_{r+1}(\varphi)$ is an isomorphism. By induction $E_m(\varphi)$ is an isomorphism for $m \geq r+1$. Hence $E_\infty(\varphi)$ is an isomorphism. By Proposition 18.1 this is identified with $\mathcal{G}H(\varphi)$. Now apply the Lemma above (and its proof) with $\psi = H(\varphi)$. \square

(d) Tensor products and extra structure.

In this topic we restrict to the case \mathbb{k} is a field.

Suppose (M, d, \mathfrak{F}) and (N, d, \mathfrak{F}) are filtered differential (graded) modules. The *tensor product* is the differential graded module $(M, d) \otimes (N, d)$ equipped with the filtration

$$F^p(M \otimes N) = \sum_{i+j=p} F^i M \otimes F^j N$$

(note: the sum on the right is NOT direct). It is straightforward to identify that if $\mathcal{G}M$ or $\mathcal{G}N$ is \mathbb{k} -projective then

$$\mathcal{G}(M \otimes N) = \mathcal{G}M \otimes \mathcal{G}N$$

as bigraded modules, compatible with the differentials.

Now we observe there are natural identifications

$$(E_r(M \otimes N), d_r) \cong (E_r(M), d_r) \otimes (E_r(N), d_r), \quad r \geq 0,$$

compatible with the isomorphisms $E_{r+1} = H(E_r, d_r)$. In fact, when $r = 0$ this is just the remark above. For $r \geq 1$ it follows by an inductive application of the fact that homology commutes with tensor products (Proposition 3.3).

Example 1 *Filtered differential graded algebras.*

Suppose (A, d) is a dga equipped with a filtration $\{F^p\}$ such that F^p is preserved by d and satisfies $F^p \cdot F^q \subset F^{p+q}$. Then multiplication

$$(A, d) \otimes (A, d) \longrightarrow (A, d)$$

is filtration preserving and hence determines a morphism of spectral sequences

$$(E_r, d_r) \otimes (E_r, d_r) \longrightarrow (E_r, d_r).$$

This identifies each (E_r, d_r) as a differential graded algebra with $H(E_r) \cong E_{r+1}$ as graded algebras: we say (E_r, d_r) is a *spectral sequence of graded algebras*.

If the spectral sequence is convergent then E_∞ is a graded algebra. In the case of a first quadrant filtration the isomorphism $E_\infty \cong \mathcal{GH}(A)$ is an isomorphism of algebras. However the graded algebra $\text{Tot } \mathcal{GH}(A)$ may *not* be isomorphic with $H(A)$!

Exercises

1. Let $(\wedge V, d)$ be a Sullivan model. Consider the filtration $F^p(\wedge V) = \wedge^{\geq p} V$ of example 3 and the associated first quadrant spectral sequence of algebras:

$$E_1^{p,q} = (\wedge^p H(V, d_0))^{p+q} \implies H^{p+q}(\wedge V, d).$$

Prove that if $(\wedge V, d)$ is a 1-connected minimal model then $E_2 = H(\wedge V, d_1)$. When $(\wedge V, d)$ is the minimal model of $\mathbb{C}P^n$, $n \geq 3$, compute the differentials and the product in E_∞ .

2. Let $(B, d) \rightarrow (B \otimes \wedge V, d) \rightarrow (\wedge V, \bar{d})$ be a relative Sullivan model and consider the spectral sequence of algebras defined in example 2. Prove that $E_1^{p,q} = (B^p \otimes H^q(\wedge V, \bar{d}), d_1)$, and determine d_1 using the short exact sequence $0 \rightarrow F^{p+1}/F^{p+2} \rightarrow F^p/F^{p+2} \rightarrow B^p \otimes \wedge V \rightarrow 0$. Prove that if $B^1 = 0$, then $E_2^{p,q} = H^p(B, d) \otimes H^q(\wedge V, \bar{d})$.

3. Let $(\wedge U \otimes \wedge V, d)$ be a relative Sullivan model such that $\dim V < \infty$ and such that the algebra $H(\wedge U, d)$ is finitely generated. Denote by α_i for $i = 1, 2, \dots, n$ (resp. v_i) a linear basis of the space $(H^+(\wedge U)/H^+(\wedge U) \cdot H^+(\wedge U))^{\text{even}}$ (resp. of the space V). Prove that if $dv_i = a_i^2$ for some cocycle a_i in $\wedge U$ representing α_i , then $\dim H(\wedge U \otimes \wedge V, d) < \infty$.

4. Let $F \rightarrow X \rightarrow Y$ be a fibration as in theorem 15.3. Construct a spectral sequence (*the rational Serre spectral sequence*):

$$E_2^{p,q} = H^p(Y; \mathbb{Q}) \otimes H^q(F; \mathbb{Q}) \implies H^{p+q}(X; \mathbb{Q}).$$

a) Prove that $H(j) : H^*(X; \mathbb{Q}) \rightarrow H^*(F; \mathbb{Q})$ is onto if and only if the rational Serre spectral sequence collapses at the E_2 -term and thus $H^*(X; \mathbb{Q}) \cong H^*(Y; \mathbb{Q}) \otimes H^*(F; \mathbb{Q})$ as graded vector spaces.

b) Prove that if $H_*(F; \mathbb{I}k) = \wedge x$ with x of odd degree then $H_*(X, \mathbb{I}k)$ is isomorphic to $H_*(Y, \mathbb{I}k)/(dx) \oplus s^{\text{deg } x} A$ where A denotes the annihilator of dx in $H_*(Y, \mathbb{I}k)$.

5. Show that the filtration of a CW complex X by its skeleton induces a first quadrant spectral sequence

$$E_1^{p,q} = H^{p+q}(X^p, X^{p-1}; \mathbb{k}) \implies H^{p+q}(X, \mathbb{k})$$

which collapses at the E_2 -term.

6. Suppose that $E_2^{p,q} = 0$ unless $q = 0$ or $q = n$. Show that $E_\infty^{*,n} = \text{Ker } d_{n+1}$. Deduce the short exact sequence

$$0 \rightarrow E_\infty^{p,n} \rightarrow E_2^{p,n} \xrightarrow{d_{n+1}} E_2^{p+n+1,0} \rightarrow E_\infty^{p+n+1,0} \rightarrow 0.$$

7. Let $F \xrightarrow{j} X \xrightarrow{f} Y$ be a fibration with 1-connected base Y . Suppose further that $H^i(Y; \mathbb{Q}) = 0$ for $1 \leq i < p$ and $H^j(F; \mathbb{Q}) = 0$ for $0 < j < q$. Prove that there is a long exact sequence

$$\begin{aligned} 0 \rightarrow H^1(X; \mathbb{Q}) \xrightarrow{H^*j} H^1(F; \mathbb{Q}) \rightarrow H^2(Y; \mathbb{Q}) \xrightarrow{H^*f} H^2(X; \mathbb{Q}) \rightarrow \dots \\ \dots \rightarrow H^{p+q-2}(F; \mathbb{Q}) \rightarrow H^{p+q-1}(Y; \mathbb{Q}) \xrightarrow{H^*f} H^{p+q-1}(X; \mathbb{Q}) \xrightarrow{H^*j} H^{p+q-1}(F; \mathbb{Q}). \end{aligned}$$

8. Consider the Serre fibration $G/K \rightarrow BK \xrightarrow{Bj} BG$ as defined in §15 f, example 1. Deduce from exercise 4b that $H^*(BK; \mathbb{Q})$ is a finitely generated $H^*(BG; \mathbb{Q})$ -module via $H^*(Bj; \mathbb{Q})$.

19 The bar and cobar constructions

In this section the ground ring is an arbitrary commutative ring \mathbb{k} . As usual $- \otimes -$ means $- \otimes_{\mathbb{k}} -$.

The bar and cobar constructions are functors

augmented differential graded algebras $\xrightarrow{B} \xrightarrow{\sim}$ co-augmented differential graded coalgebras

and

co-augmented differential graded coalgebras $\xrightarrow{\Omega} \xrightarrow{\sim}$ augmented differential graded algebras.

They were introduced, respectively, by Eilenberg-MacLane [48] who showed that $B(\mathbb{Z}[\Gamma]) \simeq C_*(K(\Gamma, 1))$ and by Adams [1] who showed that $\Omega C_*(X) \simeq C_*(\Omega X)$.

Here we give the constructions, and establish those few properties that will be essential in the sequel.

We begin with some conventions (cf. §3). The *suspension* sV of a graded module is defined by $(sV)_k = V_{k-1}$ and the correspondence is denoted by $sv \leftrightarrow v$, $v \in V$. Similarly $(s^{-1}V)_k = V_{k+1}$ and $s^{-1}v \leftrightarrow v$.

Recall that the *tensor algebra* on a graded module V is the graded algebra $TV = \bigoplus_{k=0}^{\infty} T^k V$ with $T^0 V = \mathbb{k}$ and $T^k V = V \otimes \cdots \otimes V$ (k times). The multiplication $T^k V \otimes T^\ell V \rightarrow T^{k+\ell} V$ is just the tensor product, and TV is augmented by $\varepsilon : V \rightarrow 0$.

The *tensor coalgebra* on V is defined analogously. It coincides with TV as a graded module, so to avoid confusion we denote its elements by $[v_1 | \cdots | v_k]$ instead of by $v_1 \otimes \cdots \otimes v_k$. The diagonal in the tensor coalgebra is defined by

$$\Delta[v_1 | \cdots | v_k] = [v_1 | \cdots | v_k] \otimes 1 + \sum_{i=1}^{k-1} [v_1 | \cdots | v_i] \otimes [v_{i+1} | \cdots | v_k] + 1 \otimes [v_1 | \cdots | v_k].$$

The tensor coalgebra is augmented by ε and co-augmented by $\mathbb{k} = T^0 V$. Note that the diagonal is not compatible with the tensor algebra structure.

Now suppose $\varepsilon : (A, d_A) \rightarrow \mathbb{k}$ is an augmented dga and denote $\ker \varepsilon$ by I .

Definition The *bar construction* on (A, d_A) is the co-augmented differential graded coalgebra BA defined as follows:

- As a co-augmented graded coalgebra BA is the tensor coalgebra $T(sI)$ on sI .
- The differential in BA is the sum $d = d_0 + d_1$ of the coderivations given by

$$d_0([sa_1 | \cdots | sa_k]) = - \sum_{i=1}^k (-1)^{n_i} [sa_1 | \cdots | sd_A a_i | \cdots | sa_k]$$

and

$$\begin{cases} d_1([sa]) = 0 \\ d_1([sa_1|\cdots|sa_k]) = \sum_{i=2}^k (-1)^{n_i} [sa_1|\cdots|sa_{i-1}a_i|\cdots|sa_k]. \end{cases}$$

Here $n_i = \sum_{j<i} \deg sa_j$.

Notice that d_0 reflects the differential d_A in A while d_1 is defined using the multiplication. To see that $d^2 = 0$ note that $d_0^2 = 0$ because $d_A^2 = 0$, $d_0d_1 + d_1d_0 = 0$ because d_A is a derivation in A and $d_1^2 = 0$ because A is associative.

We shall adopt the notation $BA = \bigoplus_k B^k A$ with $B^k A = T^k(sI)$. The notation ‘ BA ’ is an abuse; we should really write $B(A, d)$ or $B(A, d, \varepsilon)$, and we will in fact write $B(A, d)$ when there are several possible differentials in A .

More generally, if (M, d) is a left (A, d_A) -module (cf. §3) then the *bar construction on (A, d_A) with coefficients in (M, d)* is the complex $B(A; M) = BA \otimes M$ with differential $d = d_0 + d_1$ where

$$\begin{aligned} d_0[sa_1|\cdots|sa_k]m &= - \sum_{i=1}^k (-1)^{n_i} [sa_1|\cdots|sd_A a_i|\cdots|sa_k]m \\ &\quad - (-1)^{n_{k+1}} [sa_1|\cdots|sa_k]dm \end{aligned}$$

and

$$\begin{aligned} d_1[sa_1|\cdots|sa_k]m &= \sum_{i=2}^k (-1)^{n_i} [sa_1|\cdots|sa_{i-1}a_i|\cdots|sa_k]m \\ &\quad + (-1)^{n_{k+1}} [sa_1|\cdots|sa_{k-1}]a_k \cdot m. \end{aligned}$$

Of course $d_0m = dm$, $d_1m = 0$ and $d_1[sa]m = (-1)^{\deg a+1} a \cdot m$.

We also adopt the convention: $B^k(A; M) = B^k A \otimes M$, and elements in $B^k A$ or $B^k(A; M)$ have *wordlength* k .

Note as well that if we consider \mathbb{k} as an (A, d_A) -module via ε then $(BA, d) = (B(A; \mathbb{k}), d)$.

Henceforth we shall denote our differential graded algebras by (A, d) since it will always be clear from the context whether “ d ” refers to the differential in A or in $B(A; M)$.

There are two situations in which it is easy to compute $H(B(A; M))$. The first arises when A is a tensor algebra. Thus suppose

$$A = TV \text{ and either } V = \{V_i\}_{i \geq 0} \text{ or } \{V^i\}_{i \geq 2}.$$

Let $d_V : V \rightarrow V$ be the linear part of the differential in A , so that $d - d_V : V \rightarrow T^{\geq 2}V$, and define

$$\bar{d} : sV \rightarrow sV$$

by $\bar{d}sv = -sd_V v$.

Now here $I = T^{\geq 1}V$. Define a morphism of complexes

$$\varrho : (B(TV, d), d) \longrightarrow (sV \oplus \mathbb{k}, \bar{d})$$

by the conditions:

$$\varrho 1 = 1, \quad \varrho[sv] = sv, \quad \varrho[s(v_1 \otimes \cdots \otimes v_\ell)] = 0, \quad \ell \geq 2$$

and $\varrho = 0$ in $B^{\geq 2}(TV)$.

Proposition 19.1 *With the notation above, ϱ is a quasi-isomorphism.*

proof: Since ϱ is surjective we need only show $H(\ker \varrho) = 0$. Define $h : B(TV) \longrightarrow \ker \varrho$ by $h(1) = 0$ and

$$h : \begin{cases} [sv|\cdots] \longrightarrow 0, & v \in V \\ [s(v_1 \otimes \cdots \otimes v_\ell)|\cdots] \longmapsto (-1)^{\deg v_1 + 1} [sv_1 | s(v_2 \otimes \cdots \otimes v_\ell) | \cdots], & \ell \geq 2. \end{cases}$$

A quick calculation shows that $hd_1 + d_1h = id$ in $\ker \varrho$. Since h raises wordlength and d_0 preserves it, it follows that $(id - hd - dh)$ increases wordlength in $\ker \varrho$. Similarly, $id - hd - dh$ preserves degrees.

Let $z \in \ker \varrho$ be a cycle of degree n . Then $(id - hd - dh)^n z$ has degree n and wordlength at least $n + 1$. However, our hypothesis on V implies that elements in $B^{\geq n+1}(TV)$ have degree at least $n + 1$. Thus $(id - hd - dh)^n z = 0$. Since $d(id - hd - dh)^k z = 0$ this gives $(id - dh)^n z = 0$; i.e.

$$z = dh \left(\sum_{i=0}^{n-1} (-1)^i \binom{n}{i+1} (dh)^i z \right)$$

is a boundary. □

The second situation where we can compute is when we take (A, d) as a left module over itself, via multiplication. This yields the complex

$$B(A; A) = BA \otimes A.$$

Note that $B(A; A)$ is a *right* (A, d) -module via multiplication on the right and that $B(A; M) = B(A; A) \otimes_A M$.

Proposition 19.2

- (i) *The augmentations in BA and A define a quasi-isomorphism, $\varepsilon \otimes \varepsilon : B(A; A) \xrightarrow{\cong} \mathbb{k}$.*
- (ii) *If \mathbb{k} is a field then $B(A; A)$ is a semifree right (A, d) -module. Thus $\varepsilon \otimes \varepsilon$ is an (A, d) -semifree resolution of \mathbb{k} .*

proof: (i) Define $h : B(A; A) \rightarrow \ker(\varepsilon \otimes \varepsilon)$ by

$$h : \begin{cases} a \mapsto (-1)^e [s(a - \varepsilon a)] 1 \\ [sa_1 | \cdots | sa_k] a \mapsto (-1)^e [sa_1 | \cdots | sa_k] s(a - \varepsilon a) 1, \quad k \geq 1 \end{cases}$$

where $e = \deg[sa_1 | \cdots | sa_k] a$. An easy computation gives $id = dh + hd$ in $\ker(\varepsilon \otimes \varepsilon)$, so that $H(\ker(\varepsilon \otimes \varepsilon)) = 0$.

(ii) Since $B(A; A)$ is the increasing union of the submodules $B^{\leq k} A \otimes A$, it is sufficient to show that (Lemma 6.3) the quotient modules $(B^{\leq k} A / B^{< k} A) \otimes A$ are (A, d) -semifree. These quotients may be identified as $(T^k sI, d_0) \otimes (A, d)$. Thus the inclusions $\ker d_0 \otimes (A, d) \hookrightarrow (T^k sI, d_0) \otimes (A, d)$ exhibit these quotients as semifree. \square

The cobar construction is a precise dual analogue of the bar construction. Suppose (C, d) is a co-augmented differential graded coalgebra with comultiplication $\Delta : C \rightarrow C \otimes C$ (cf. §3(d)). Let \bar{C} be the kernel of the augmentation $\varepsilon : C \rightarrow k$. Then (cf. §3(d))

$$\Delta c - (c \otimes 1 + 1 \otimes c) \in \bar{C} \otimes \bar{C}, \quad c \in \bar{C}.$$

Define $\bar{\Delta} : \bar{C} \rightarrow \bar{C} \otimes \bar{C}$ by $\bar{\Delta} c = \Delta c - c \otimes 1 - 1 \otimes c$. This map is called the *reduced comultiplication* and is also coassociative: $(\bar{\Delta} \otimes id) \bar{\Delta} = (id \otimes \bar{\Delta}) \bar{\Delta} : \bar{C} \rightarrow \bar{C} \otimes \bar{C} \otimes \bar{C}$.

Definition The *cobar construction on (C, d)* is the augmented differential graded algebra ΩC defined as follows:

- As an augmented graded algebra ΩC is the tensor algebra $T(s^{-1} \bar{C})$ on $s^{-1} \bar{C}$.
- The differential in ΩC is the sum $d = d_0 + d_1$ of the derivations determined by

$$d_0(s^{-1} x) = -s^{-1} dx, \quad x \in \bar{C}$$

and

$$d_1(s^{-1} x) = \sum_i (-1)^{|x_i|} s^{-1} x_i \otimes s^{-1} y_i, \quad x \in \bar{C},$$

where $\bar{\Delta} x = \sum x_i \otimes y_i$.

Exercises

1. Let $f : (A, d, \epsilon) \rightarrow (A', d', \epsilon')$ be a morphism of augmented chain algebras, then the formula $Bf([sa_1 | sa_2 | \cdots | sa_k]) = [sfa_1 | sfa_2 | \cdots | sfa_k]$, $k \geq 0$, defines a morphism of graded differential coalgebras $Bf : BA \rightarrow BA'$. Prove that Bf is a quasi-isomorphism if and only if f is a quasi-isomorphism.

2. Let (A, d, ϵ) be a differential graded augmented algebra. Prove that the natural morphism of differential graded algebras $\Omega BA \rightarrow A$ is a quasi-isomorphism.

3. Let (A, d, ϵ) be a 1-connected augmented cochain algebra and denote by $B^\# A$ the graded dual of the bar construction BA . Prove that $B^\# A$ is a chain algebra. Prove that if A is of finite type then $\Omega A^\# \cong B^\# A$. Let $(A, d) = (\wedge V, d)$ be a minimal model and $d_1 : V \rightarrow V \otimes V$ be the quadratic part of the differential d . Prove that $V \cong {}_s H^+(B^\# A)$ and that d_1 is dual to the multiplication in $H^+ B^\# A$.

4. Let (A, d, ϵ) and $B^\# A$ be as in exercise 3 and denote by $\langle f, a \rangle$ the pairing $B^\# A \otimes BA \rightarrow \mathbb{k}$. Prove that the action defined by $f \cdot [sa_1|sa_2|\dots|sa_k]a = \sum_{i=1}^k \langle f, [sa_1|sa_2|\dots|sa_i] \rangle [sa_{i+1}|sa_2|\dots|sa_k]$, $k \geq 0$, makes $B(A, A)$ into a right $B^\# A$ -module and that this structure is compatible with the right A -module structure. Show that the natural map $B^\# A \rightarrow \text{End}_A(B(A, A))$ is a quasi-isomorphism.

20 Projective resolutions of graded modules

In this section the ground ring is an arbitrary commutative ring, \mathbb{k} .

Our objective is to set up the classical homological functors Ext and Tor for modules over a graded algebra; of course this parallels (and includes) the standard construction in the non-graded context. Our presentation is terse, and the reader seeking a more detailed explanation is referred to [118]. The reader may also wish to review the definitions in §3(a) and §3(b).

Let A be a graded algebra (over \mathbb{k}). A *chain complex* $(\{M_{k,*}\}, d)$ of A -modules is a sequence

$$0 \xleftarrow{d} M_{0,*} \xleftarrow{d} M_{1,*} \xleftarrow{d} \cdots \xleftarrow{d} M_{k,*} \xleftarrow{d} \cdots$$

in which:

- Each $M_{k,*}$ is an A -module, with $M_{k,i}$ the component of $M_{k,*}$ of degree $k+i$.
- Each d is an A -linear map of degree -1 ; i.e., $d : M_{k,i} \rightarrow M_{k-1,i}$.
- $d^2 = 0$.

Notice that (cf. §18(a)) $(\text{Tot}(M), d)$ is an $(A, 0)$ -module as defined in §3(c); the difference is that here we keep track of the bigrading.

A *chain map of bidegree* (p, q) between two such chain complexes is a family of A -linear maps

$$\varphi : M_{k,*} \rightarrow N_{k+p,*} \quad , \quad k \geq 0 \quad ,$$

of degree $p+q$, and satisfying $d\varphi = (-1)^{p+q}\varphi d$.

Note that the homology, $H(M_{*,*}, d)$ of a chain complex of A -modules is itself a family $\{H_{k,*}\}$ of graded A -modules and that the chain map φ induces A -linear maps $H_{k,*}(\varphi) : H_{k,*}(M) \rightarrow H_{k+p,*}(N)$ of degree $p+q$.

This section is divided into the following topics:

- (a) Projective resolutions.
- (b) Graded Ext and Tor.
- (c) Projective dimension.
- (d) Semifree resolutions.

(a) Projective resolutions.

Let A be a graded algebra. An A -module P is *projective* if $P \oplus Q$ is A -free for some second A -module Q (cf. §3(b)). In this case any A -linear map (of any degree) $\alpha : P \rightarrow M$ lifts through any surjective A -linear map $\xi : N \rightarrow M$. Indeed, extend α to $P \oplus Q$ by setting $\alpha = 0$ in Q , let $\{v_\alpha\}$ be a basis of $P \oplus Q$ and define $\hat{\alpha} : P \oplus Q \rightarrow N$ by $\hat{\alpha}v_\alpha = n_\alpha$ where $n_\alpha \in N$ satisfies $\xi n_\alpha = \alpha v_\alpha$.

Denote $A_{>0}$ by A_+ (cf. §3).

Remark 1 If $A = \mathbb{k} \oplus A_+$ then any A -projective P concentrated in degrees $\geq m$, some $m \in \mathbb{Z}$, is A -free.

In fact write $P \oplus Q = V \otimes A$ for some \mathbb{k} -free module V . Apply $- \otimes_A \mathbb{k}$ to obtain $(P \otimes_A \mathbb{k}) \oplus (Q \otimes_A \mathbb{k}) = V$. Thus $\bar{P} = P \otimes_A \mathbb{k}$ is \mathbb{k} -projective and splits back into P . This inclusion extends uniquely to an A -linear map $\sigma : \bar{P} \otimes A \rightarrow P$. But clearly $P = \sigma \bar{P} \oplus P \cdot A_+ = \sigma \bar{P} \cdot A + P \cdot A_+$. Iterating gives $P = \sigma \bar{P} \cdot A + P \cdot (A_+ \cdots A_+)$. Choosing $n - m + 1$ factors A_+ we see that $P_n = (\sigma \bar{P} \cdot A)_n$; i.e., σ is surjective. Choose an A -linear map $\tau : P \rightarrow \bar{P} \otimes A$ so $\sigma \tau = id$. Then $\tau \sigma(\bar{P}) \oplus (\bar{P} \otimes A_+) = \bar{P} \otimes A$ and it follows as with σ that τ is surjective. Hence τ is an isomorphism, and P is A -free.

A projective (free) resolution of an A -module, M is a chain complex $(P, d) = (\{P_{k,*}\}, d)$ of projective (free) A -modules together with a morphism of degree zero, $\varrho : P_{0,*} \rightarrow M$ such that

$$0 \leftarrow M \xleftarrow{\varrho} P_{0,*} \xleftarrow{d} P_{1,*} \xleftarrow{d} \dots$$

is exact.

Remark 2 Think of $M = \{M_{0,*}\}$ as a trivial chain complex of A -modules. Then a projective (free) resolution is just a quasi-isomorphism $\varrho : (P, d) \rightarrow (M, 0)$ of bidegree $(0, 0)$.

Remark 3 Suppose $\varrho : (P, d) \rightarrow (M, 0)$ is a free resolution. Regard ϱ as a quasi-isomorphism $(\text{Tot}(P), d) \xrightarrow{\cong} (M, 0)$. Filtering $\text{Tot}(P)$ by the submodules $\text{Tot} \left(\bigoplus_{i=0}^k P_{i,*} \right)$ then exhibits this as an $(A, 0)$ -semifree resolution of $(M, 0)$.

Analogous to Proposition 6.6(i) we have

Lemma 20.1 Every A -module M has a free resolution.

proof: Choose an A -linear surjection of degree zero, $\varrho : P_{0,*} \rightarrow M$, from a free A -module $P_{0,*}$. If

$$M \xleftarrow{\varrho} P_{0,*} \xleftarrow{d} \dots \xleftarrow{d} P_{k,*}$$

is constructed choose an A -linear surjection d of bidegree $(-1, 0)$ from a free A -module $P_{k+1,*}$ onto $\ker d \subset P_{k,*}$. □

Next, suppose given the diagram

$$\begin{array}{ccc} & & (N, d) \\ & & \downarrow \xi \\ (P, d) & \xrightarrow{\alpha} & (M, d) \end{array}$$

in which the objects are all chain complexes of A -modules and α and ξ are morphisms respectively of bidegrees (p, q) and (m, n) .

Analogous to Proposition 6.4(ii) we have

Lemma 20.2 *Suppose the A -modules $P_{k,*}$ are projective and ξ is a surjective quasi-isomorphism. Put $r = (p + q) - (m + n)$. Then*

(i) *There is a morphism $\beta : (P, d) \rightarrow (N, d)$ of bidegree $(p - m, q - n)$, and such that $\xi\beta = \alpha$.*

(ii) *If $\hat{\beta}$ is a second such morphism then $\beta - \hat{\beta} = d\gamma + (-1)^r\gamma d$, for some A -linear map $\gamma : P \rightarrow \ker \xi$ of bidegree $(p - m + 1, q - n)$.*

proof: (i) Suppose β constructed in $P_{i,*}$, $i < k$. Since $P_{k,*}$ is projective there is an A -linear map $\beta' : P_{k,*} \rightarrow N$ such that $\xi\beta' = \alpha$. Clearly $d\beta' - (-1)^r\beta d$ sends $P_{k,*}$ into the cycles of $\ker \xi$. Since, by hypothesis, $H(\ker \xi) = 0$, it follows that $d : \ker \xi \rightarrow \text{cycles}(\ker \xi)$ is surjective. Choose $\beta'' : P_{k,*} \rightarrow \ker \xi$ so that $d\beta'' = d\beta' - (-1)^r\beta d$ and set $\beta = \beta' - \beta''$ in $P_{k,*}$.

(ii) Note that $\beta - \hat{\beta} : (P, d) \rightarrow (\ker \xi, d)$. If γ is constructed in $P_{i,*}$, $i < k$ then $\beta - \hat{\beta} - (-1)^r\gamma d$ sends $P_{k,*}$ into the cycles of $\ker \xi$. Again, $d : \ker \xi \rightarrow \text{cycles}(\ker \xi)$ is surjective, which permits us to construct $\gamma : P_{k,*} \rightarrow \ker \xi$ so that $d\gamma = \beta - \hat{\beta} - (-1)^r\gamma d$. □

(b) Graded Ext and Tor.

Fix a graded algebra, A , and A -modules M and N (both left, or both right), and choose a projective resolution $\varrho : (P = \{P_{k,*}\}, d) \xrightarrow{\cong} (M, 0)$. Then $\text{Hom}_A(P_{k,*}, N)$ is the graded module of A -linear maps (cf. §3(b)), and

$$0 \rightarrow \text{Hom}_A(P_{0,*}, N) \xrightarrow{\delta} \text{Hom}_A(P_{1,*}, N) \xrightarrow{\delta} \dots \tag{20.3}$$

is the cochain complex of graded modules defined by $\delta(f) = -(-1)^{\text{deg } f}fd$.

We use the standard convention to raise degrees, and denote the graded module $\text{Hom}_A(P_{k,*}, N)$ by $\text{Hom}_A^{k,*}(P, N)$:

$$\text{Hom}_A^{k,\ell}(P, N) = \text{Hom}_A(P_{k,*}, N)_{-(k+\ell)} .$$

Thus the cochain complex (20.3) has the form $(\text{Hom}_A(P, N), \delta)$ with δ of bidegree $(1, 0)$ and its homology is a bigraded \mathbb{k} -module, $H^{*,*}(\text{Hom}_A(P, N), \delta)$.

.. If $\varrho' : (P', d) \xrightarrow{\cong} (M, 0)$ is a second projective resolution then Lemma 20.2(i) provides us with a morphism $\beta : (P, d) \rightarrow (P', d)$ such that $\varrho'\beta = \varrho$, while it follows from Lemma 20.2(ii) that $H(\text{Hom}_A(\beta, N))$ is independent of the choice of β . Reversing the roles of (P, d) and (P', d) yields a morphism $\beta' : (P', d) \rightarrow (P, d)$ and Lemma 20.2(ii) implies that $\beta\beta' \sim_A id_{P'}$ while $\beta'\beta \sim_A id_P$. Thus $H(\text{Hom}_A(\beta, N))$ and $H(\text{Hom}_A(\beta', N))$ are canonical inverse isomorphisms, and we use them to identify $H^{*,*}(\text{Hom}_A(P, N))$ with $H^{*,*}(\text{Hom}_A(P', N))$. Thus we may make the

Definition For each $k \geq 0$, $\text{Ext}_A^k(M, N)$ is the graded module $H^{k,*}(\text{Hom}_A(P, N), \delta)$. (Where necessary we write $\text{Ext}_A^{k,\ell}(M, N) = H^{k,\ell}$; recall that this is the component of degree $k + \ell$.)

Notice that this construction is functorial. Indeed, if $\alpha : M' \rightarrow M$ and $\beta : N \rightarrow N'$ are morphisms of A -modules then (Lemma 20.2) α lifts to a morphism $\hat{\alpha} : (P', d) \rightarrow (P, d)$ between projective resolutions for M' and M and $\text{Hom}_A(\hat{\alpha}, \beta)$ is a morphism of cochain complexes inducing the canonical linear maps

$$\text{Ext}_A^k(\alpha, \beta) : \text{Ext}_A^k(M, N) \rightarrow \text{Ext}_A^k(M', N') .$$

In the same way, if L is any A -module (left if M is right, right if M is left) then

$$0 \leftarrow P_{0,*} \otimes_A L \xleftarrow{d \otimes id} P_{1,*} \otimes_A L \xleftarrow{d \otimes id} \dots \quad (20.4)$$

is a chain complex of graded modules $(P \otimes_A L = \{P_{k,*} \otimes_A L\}, d)$ whose homology is a bigraded module independent of the choice of resolution.

Definition For each $k \geq 0$, $\text{Tor}_k^A(M, L)$ is the graded module $H_{k,*}(P \otimes_A L, d)$. (Where necessary we write $\text{Tor}_{k,\ell}^A(M, L) = H_{k,\ell}$; this is the component of degree $k + \ell$.)

Notice that this construction too is functorial. If $\alpha : M' \rightarrow M$ and $\gamma : L' \rightarrow L$ then lift α to a morphism, $\hat{\alpha}$, of projective resolutions and define

$$\text{Tor}_k^A(\alpha, \beta) = H_{k,*}(\hat{\alpha} \otimes_A \beta) .$$

We turn now to the elementary properties of these functors. Observe first that if $\varrho : (P, d) \rightarrow (M, 0)$ is a projective resolution then the surjection $\varrho : P_{0,*} \rightarrow M$ induces natural isomorphisms

$$\text{Ext}_A^0(M, N) = \text{Hom}_A(M, N) \quad \text{and} \quad \text{Tor}_0^A(M, L) = M \otimes_A L . \quad (20.5)$$

Next, suppose

$$0 \rightarrow M' \xrightarrow{\alpha} M \xrightarrow{\beta} M'' \rightarrow 0$$

is a short exact sequence of A -linear maps. (We do *not* require that α and β have degree zero.) Let $\varrho' : (P', d) \xrightarrow{\cong} (M', 0)$ be a projective resolution. It is trivial to modify the construction in the proof of Lemma 20.1 to obtain a projective resolution $\varrho : (P, d) \xrightarrow{\cong} (M, 0)$ of the following form: each $P_{k,*} = P'_{k,*} \oplus P''_{k,*}$, each $P_{k,*}$ is projective, and the inclusion $\lambda : P' \subset P$ commutes with the differentials and satisfies $\varrho\lambda = \varrho'$.

In this case the quotient $(P/P', d)$ is the chain complex of projective modules $P''_{k,*}$. The induced row exact diagram

$$\begin{array}{ccccccc}
 0 & \longrightarrow & (P', d) & \xrightarrow{\lambda} & (P, d) & \xrightarrow{\bar{\pi}} & (P/P', d) \longrightarrow 0 \\
 & & \downarrow e' \simeq & & \downarrow e \simeq & & \downarrow e'' \\
 0 & \longrightarrow & (M', 0) & \longrightarrow & (M, 0) & \longrightarrow & (M'', 0) \longrightarrow 0
 \end{array}$$

exhibits ρ'' as a projective resolution of M'' (pass to the long exact homology sequences and apply the Five lemma 3.1).

Note that (forgetting differentials) $P = P' \oplus P/P'$ as families of A -modules. Hence if N is any A -module,

$$0 \longleftarrow \text{Hom}_A(P', N) \longleftarrow \text{Hom}_A(P, N) \longleftarrow \text{Hom}_A(P/P', N) \longleftarrow 0$$

is a short exact sequence of cochain complexes of graded modules. Passing to homology gives the long exact sequence

$$\longleftarrow \text{Ext}_A^{k+1}(M'', N) \xleftarrow{\delta^*} \text{Ext}_A^k(M', N) \longleftarrow \text{Ext}_A^k(M, N) \longleftarrow \text{Ext}_A^k(M'', N) \longleftarrow \dots \tag{20.6}$$

Similarly we obtain the long exact sequence

$$\longrightarrow \text{Tor}_k^A(M', L) \longrightarrow \text{Tor}_k^A(M, L) \longrightarrow \text{Tor}_k^A(M'', L) \xrightarrow{\partial_*} \text{Tor}_{k-1}^A(M', L) \longrightarrow \dots \tag{20.7}$$

Finally, if Q is a projective A -module then $\text{Hom}_A(Q, -)$ and $Q \otimes_A -$ preserve short exact sequences (this is immediate from the definition). From this it follows that $\text{Hom}_A(P, -)$ and $P \otimes_A -$ convert short exact sequences

$$0 \longrightarrow N' \longrightarrow N \longrightarrow N'' \longrightarrow 0 \quad \text{and} \quad 0 \longrightarrow L' \longrightarrow L \longrightarrow L'' \longrightarrow 0$$

into short exact sequences of complexes, whence the long exact sequences

$$\longrightarrow \text{Ext}_A^k(M, N') \longrightarrow \text{Ext}_A^k(M, N) \longrightarrow \text{Ext}_A^k(M, N'') \xrightarrow{\delta^*} \text{Ext}_A^{k+1}(M, N') \longrightarrow \dots \tag{20.8}$$

and

$$\longrightarrow \text{Tor}_k^A(M, L') \longrightarrow \text{Tor}_k^A(M, L) \longrightarrow \text{Tor}_k^A(M, L'') \xrightarrow{\partial_*} \text{Tor}_{k-1}^A(M, L') \dots \tag{20.9}$$

Example 1 *The bar construction.*

Suppose k is a field and $A \xrightarrow{\varepsilon} k$ is an augmented algebra, with no differential. Then the bar construction with coefficients in A (§19) has the form

$$k \xleftarrow{\varepsilon} A \xleftarrow{d} B^1(A; A) \xleftarrow{d} B^2(A; A) \xleftarrow{\dots}$$

and Proposition 19.2 exhibits this as an A -free resolution of k . But for any left A -module N we have $B(A; N) = B(A; A) \otimes_A N$. It follows that

$$\text{Tor}^A(k, N) = H(B(A; N)) .$$

□

(c) Projective dimension.

As usual, fix a graded algebra, A . The *projective dimension* of an A -module M , denoted $\text{proj dim}_A(M)$, is the least k (or ∞) such that M admits a projective resolution of the form

$$M \leftarrow P_{0,*} \leftarrow P_{1,*} \leftarrow \cdots \leftarrow P_{k,*} \leftarrow 0 .$$

Proposition 20.10 For any A -module, M ,

$$\text{proj dim}_A(M) = \sup \left\{ k \mid \text{Ext}_A^k(M, -) \text{ is non-zero} \right\} .$$

proof: Denote the right hand side of the equation by $p(M)$. If M has a projective resolution of the form above then we can use it to compute $\text{Ext}_A^n(M, -)$ and it follows at once that $\text{Ext}_A^n(M, -) = 0, n > k$. Hence $p(M) \leq \text{proj dim}_A(M)$.

Conversely, suppose $p(M)$ is finite and let $\varrho : (\{P_{k,*}\}, d) \rightarrow (M, 0)$ be any projective resolution. For simplicity write $p = p(M)$. Let $Z \subset P_{p,*}$ be the submodule of cycles ($Z = \ker d$). Then the differential, d , maps $P_{p+1,*}$ onto Z ; denote this linear map by $f : P_{p+1,*} \rightarrow Z$.

In particular $f \in \text{Hom}_A^{p+1,*}(P, Z)$ and $\delta f = f \circ d = d^2 = 0$. Since $\text{Ext}_A^{p+1}(M, -) = 0$ by hypothesis, f must satisfy $f = g \circ d$ for some $g : P_{p,*} \rightarrow Z$. In other words, for $x \in P_{p+1,*}, dx = f(x) = g(dx)$. Thus g restricts to the identity in Z and $P_{p,*} = Z \oplus \ker g$. In particular $\ker g$ is projective and

$$M \leftarrow P_{0,*} \xleftarrow{d} \cdots \xleftarrow{d} P_{p-1,*} \xleftarrow{d} \ker g \leftarrow 0$$

is a projective resolution, whence $\text{proj dim}_A(M) \leq p(M)$. □

(d) Semifree resolutions.

Now let (A, d_A) be a differential graded algebra and let $m : (P, d) \xrightarrow{\cong} (M, d)$ be a semifree resolution of an arbitrary right (A, d_A) -module, (M, d) . As observed in the Remark at the start of §6(a) (with completely different notation!) we may use a semifree filtration of (P, d) to write

$$P = V \otimes A, \quad V = \bigoplus_{k=0}^{\infty} V(k) ,$$

where each $V(k)$ is a free graded (\mathbb{k} -) module and the semifree filtration is given by $P(k) = \bigoplus_{i=0}^k V(i) \otimes A$. In particular $d : V(k) \rightarrow P(k - 1)$.

Now m restricts to $m(0) : V(0) \otimes (A, d_A) \rightarrow (M, d)$. Moreover the filtration gives rise to a homology spectral sequence (§18) which we denote by $(E^i, d^i)_{i \geq 0}$. Clearly $E_k^0 = V(k) \otimes (A, d_A)$ and so $E_k^1 = H(E_k^0, d^0) = V(k) \otimes H(A)$ because $V(k)$ is \mathbb{k} -free. Thus we obtain the sequence

$$H(M) \xleftarrow{H(m(0))} V(0) \otimes H(A) \xleftarrow{d^1} V(1) \otimes H(A) \leftarrow \dots$$

in which all but the first term form a chain complex of $H(A)$ -modules.

Definition If this sequence is exact, and hence a free resolution of the $H(A)$ -module $H(M)$ then $m : (P, d) \xrightarrow{\cong} (M, d)$ is called an *Eilenberg-Moore resolution* of (M, d) .

Proposition 20.11 *Each (M, d) has an Eilenberg-Moore resolution. More precisely, any $H(A)$ -free resolution of $H(M)$ appears as the E^1 -term of some semifree resolution of (M, d) .* **proof:** Fix a free resolution

$$H(M) \xleftarrow{e} V(0) \otimes H(A) \xleftarrow{\partial} V(1) \otimes H(A) \xleftarrow{\partial} \dots$$

Set $V = \bigoplus_{k=0}^{\infty} V(k)$ and $P = V \otimes A$. We define the differential, d and the map m in each $V(k)$ by induction on k .

Set $d = 0$ in $V(0)$ and, if $\{v_\alpha\}$ is a basis of $V(0)$, define $m(0) : V(0) \rightarrow M$ by requiring $m(0)v_\alpha$ to be a cycle representing ρv_α . Then $H(m(0)) = \rho$ and so $H(m(0))$ is surjective.

Now $d = id \otimes d_A$ in $V(0) \otimes A$. Let $\{v_\beta\}$ be a basis of $V(1)$ and let z_β be a cycle in $V(0) \otimes A$ such that $\partial v_\beta = [z_\beta]$. Then $[mz_\beta] = \rho \partial v_\beta = 0 \in H(M)$; i.e., $mz_\beta = dx_\beta$, some $x_\beta \in M$. Extend m and d to $A \otimes V(1)$ by setting $dv_\beta = z_\beta$ and $mv_\beta = x_\beta$.

Write $P(n) = \bigoplus_{i=0}^n V(i) \otimes A$, $n \geq 0$, and suppose inductively that m and d are extended to some $P(k)$, $k \geq 1$. Write $d = \sum_{i=0}^k d_i$ with $d_0 = id \otimes d_A$ and d_i an A -linear map sending each $V(\ell)$ to $V(\ell - i) \otimes A$, $i \geq 1$. Thus $d_1 d_0 + d_0 d_1 = 0$ and our inductive assumption is that $H(d_1) = \partial : V(\ell) \otimes H(A) \rightarrow V(\ell - 1) \otimes H(A)$.

To extend m and d to $V(k + 1)$ we consider a d_0 -cycle $z \in V(k) \otimes A$ such that $\partial[z] = 0$, $[z]$ denoting the class in $V(k) \otimes H(A)$, and we show that

- *There exist $w \in P(k - 1)$ and $x \in M$ such that $d(z - w) = 0$ and $m(z - w) = dx$.* (20.12)

The construction proceeds via the following steps.

Step 1: Since $\partial[z] = 0$, $d_1 z = d_0 z'$ ($z' \in V(k-1) \otimes A$) and $d(z - z') \in P(k-2)$.

Step 2: Suppose for some $y' \in P(k-1)$ that $d(z - y') = \sum_0^\ell u_i$ with $u_i \in V(i) \otimes A$ and $1 \leq \ell \leq k-2$. Then $\sum du_i = 0$, whence $d_0 u_\ell = 0$ and $d_1 u_\ell = -d_0 u_{\ell-1}$. This gives $\partial[u_\ell] = 0$. By exactness $[u_\ell] = \partial[u']$ for some d_0 -cycle u' , and so $u_\ell = d_1 u' + d_0 u''$, with $u' \in V(\ell+1) \otimes A$ and $u'' \in V(\ell) \otimes A$.

Altogether we have $d(z - y' - u' - u'') \in P(\ell-1)$. Iterating this procedure we find $y \in P(k-1)$ so that

$$d(z - y) \in V(0) \otimes A .$$

Step 3: The class $[d(z - y)] \in V(0) \otimes H(A)$ may be non zero, but $\rho[d(z - y)]$ is represented by the boundary $dm(z - y)$ and so $\rho[d(z - y)] = 0$. By exactness $[d(z - y)] = \partial[y_1]$ for some d_0 -cycle $y_1 \in V(1) \otimes A$. Thus for some $y_0 \in V(0) \otimes A$ we have

$$d(z - y) = dy_1 + dy_0 .$$

Step 4: The cycle $z - y - y_1 - y_0$ is mapped by m to a cycle, which is necessarily of the form $m(z_0) + dx$ for some cycle $z_0 \in V(0) \otimes A$. Set $w = y + y_1 + y_0 + z_0$.

This completes the proof of (20.12). Now let $\{v_\lambda\}$ be a basis of $V(k+1)$, write $\partial v_\lambda = [z_\lambda]$ and note that $\partial[z_\lambda] = \partial^2 v_\lambda = 0$. By (20.12) there are elements $w_\lambda \in P(k-1)$ and $x_\lambda \in M$ such that $d(z_\lambda - w_\lambda) = 0$ and $m(z_\lambda - w_\lambda) = dx_\lambda$. Extend d and m to $V(k+1) \otimes A$ by setting $dv_\lambda = z_\lambda - w_\lambda$ and $mv_\lambda = x_\lambda$.

This completes the construction of d and m . Clearly m is a morphism of (A, d_A) -modules, (P, d) is semifree and the E^1 -term of the spectral sequence is as desired. Finally, since $H(m(0))$ is surjective, $H(m)$ certainly is.

To show $H(m)$ is injective let α be a class represented by a cycle $z \in P(k)$. Put $z = \sum z_i$, $z_i \in V(i) \otimes A$. Then $d_0 z_k = 0$ and $\partial[z_k] = 0$. By exactness $[z_k] = \partial[w']$ and so $z_k = d_1 w' + d_0 w''$ for some d_0 -cycle $w' \in V(k+1) \otimes A$, and some $w'' \in V(k) \otimes A$. It follows that $z - d(w' + w'') \in P(k-1)$.

In summary, any class α in $H(P)$ is represented by a cycle $z_0 \in V(0) \otimes A$. If $H(m)\alpha = 0$ then $\rho[z_0] = 0$, $[z_0] = \partial[z'_1]$ and $z_0 = d(z'_1 + z''_0)$; i.e. $\alpha = 0$. \square

Example 1 *The Eilenberg-Moore spectral sequence.*

Suppose (M, d) is a right (A, d_A) -module with a semifree resolution $(P, d) \xrightarrow{\sim} (M, d)$ as constructed in Proposition 20.11. If (N, d) is any left (A, d_A) -module then the filtration $\{P(k)\}$ defines the filtration

$$P(0) \otimes_A N \subset P(1) \otimes_A N \subset \cdots \subset P(k) \otimes_A N \subset \cdots$$

of $P \otimes_A N$.

This leads to the (fundamental) *Eilenberg-Moore spectral sequence*, whose E^1 -term is just $(\{V(k) \otimes H(A)\}, \partial) \otimes_{H(A)} H(N)$. The left hand tensorand is an

$H(A)$ -free resolution of $H(M)$. Thus the E^2 -term of the Eilenberg-Moore spectral sequence is given by

$$E_{k,*}^2 = \text{Tor}_k^{H(A)}(H(M), H(N)) .$$

Under simple hypotheses the spectral sequence converges to $H(P \otimes_A N)$. As shown in §6, this homology is a functor, independent of the choice of semifree resolution. It is called the *differential tor*, $\text{Diff Tor}^A(M, N)$ and so the Eilenberg-Moore spectral sequence converges (usually) from

$$\text{Tor}^{H(A)}(H(M), H(N)) \implies \text{Diff Tor}^A(M, N) .$$

□

Exercises

1. Let (A, ε) be an augmented graded algebra and $\bar{A} = \ker \varepsilon$. Using §20 b, example 1, prove that $\text{Tor}_1^A(Ik, Ik) \cong \bar{A}/\bar{A}\bar{A}$.

2. Let (A, ε) be a graded augmented algebra. Compute the projective dimension of the trivial A -module Ik when a) $A = T(V)$, b) $A = \wedge V, \dim V < \infty$, c) $A = Ik[x]/(x^n)$.

3. Let $F \rightarrow X \rightarrow Y$ be a fibration with Y 1-connected and let M be a semifree $C^*(Y; Ik)$ -resolution of $C^*(X; Ik)$. Prove that $C^*(P(Y, y_0); Ik) \otimes_{C^*(Y; Ik)} M$ is a resolution of $C^*(F; Ik)$. Deduce the *Eilenberg-Moore spectral sequence of a fibration*

$$\text{Tor}^{H^*(Y; Ik)}(Ik, H^*(X, Ik)) \implies H^*(F, Ik).$$

4. Let $F \rightarrow X \rightarrow Y$ be a fibration with 1-connected base and let Ik be a field of characteristic zero. Assuming that the Serre spectral sequence of the fibration collapses at the E_2 -term, prove that the graded algebra $H^*(F, Ik)$ is isomorphic to the quotient algebra $Ik \otimes_{H^*(Y; Ik)} H^*(X, Ik)$.

5. Let $P \rightarrow X$ be a G -fibration as in theorem 8.3. Using the spectral sequence associated to a semifree resolution construct a spectral sequence

$$\text{Tor}^{H_*(G; Ik)}(Ik, H_*(P, Ik)) \implies H_*(X, Ik).$$

6. Express Theorem 7.5 in terms of differential Tor.

7. Let $X = K(G, 1)$ with universal cover \tilde{X} . Deduce from §8-exercise 1 that $H_*(X; Ik) \cong \text{Tor}^{Ik[G]}(Ik, Ik)$ and that $H^*(X, Ik) \cong \text{Ext}_{Ik[G]}(Ik, Ik)$. As an application, compute $\text{Ext}_{Ik[G]}(Ik, Ik)$ when G is a free group.

8. a) Let E and F be \mathbb{Z} -modules. Prove that $\text{Tor}_{\geq 2}^{\mathbb{Z}}(E, F) = 0$.

b) Let M and N be chain complexes over \mathbb{Z} . Deduce the following short exact sequences from the Eilenberg-Moore spectral sequence:

$$0 \rightarrow (H_*(M) \otimes H_*(N))_n \rightarrow H_n(M \otimes N) \rightarrow \bigoplus_{p+q=n-1} \text{Tor}_1^{\mathbb{Z}}(H_p(M), H_q(N)) \rightarrow 0 .$$

c) Let X and Y be topological spaces. Prove the existence of Kunneth exact sequence:

$$0 \rightarrow (H_*(X) \otimes H_*(Y))_n \rightarrow H_n(X \times Y) \rightarrow \bigoplus_{p+q=n-1} \text{Tor}_1^{\mathbb{Z}}(H_p(X),$$

Part IV

Lie Models

21 Graded (differential) Lie algebras and Hopf algebras

The ground ring in this section is a field k of characteristic zero. S_k denotes the permutation group on k symbols.

This section introduces graded Lie algebras together with associated constructions such as the universal enveloping algebra. The main example for us is the *rational homotopy Lie algebra of a topological space*, defined in (c), whose universal enveloping algebra is the loop space homology algebra.

We begin with the

Definition A *graded Lie algebra*, L , is a graded vector space $L = \{L_i\}_{i \in \mathbb{Z}}$ together with a linear map of degree zero, $L \otimes L \rightarrow L$, $x \otimes y \mapsto [x, y]$ satisfying

$$(i) \quad [x, y] = -(-1)^{\deg x \deg y} [y, x]. \quad (\text{antisymmetry})$$

$$(ii) \quad [x, [y, z]] = [[x, y], z] + (-1)^{\deg x \deg y} [y, [x, z]]. \quad (\text{Jacobi identity})$$

The product $[,]$ is called the *Lie bracket*.

A *morphism of graded Lie algebras* is a Lie bracket-preserving linear map of degree zero.

If E and F are graded subspaces of L then $[E, F]$ denotes the graded subspace of linear combinations of elements of the form $[x, y]$, $x \in E$, $y \in F$. In particular a *sub Lie algebra* (resp. an *ideal*) $E \subset L$ is a graded subspace such that $[E, E] \subset E$ (resp., $[L, E] \subset E$). In either case the restriction of the bracket makes E into a graded Lie algebra. If E is an ideal then there is a unique graded Lie algebra structure in L/E for which the quotient map $L \rightarrow L/E$ is a morphism of graded Lie algebras. Given a subset $S \subset L$ the sub Lie algebra (or ideal) *generated by* S is the intersection of all the sub Lie algebras (or ideals) containing S .

The subspace $[L, L]$ is an ideal, called the *derived sub Lie algebra*, and L is *abelian* if $[L, L] = 0$; i.e. if $[x, y] = 0$ for all $x, y \in L$.

Example 1 *Graded algebras.*

Recall that graded algebras A are associative by definition (§3(b)). A Lie bracket (called the *commutator*) is defined in A by

$$[x, y] = xy - (-1)^{\deg x \deg y} yx$$

with the Jacobi identity following from the associativity. Note that this Lie algebra is abelian if and only if A is commutative. \square

Let L be a graded Lie algebra. A (*left*) L -*module* is a graded vector space V together with a degree zero linear map $L \otimes V \rightarrow V$, $x \otimes v \mapsto x \cdot v$, such that

$$[x, y] \cdot v = x \cdot (y \cdot v) - (-1)^{\deg x \deg y} y \cdot (x \cdot v).$$

A *right* L -*module* is a graded vector space V together with a degree zero linear map $v \otimes x \mapsto v \cdot x$ such that $v \cdot [x, y] = (v \cdot x) \cdot y - (-1)^{\deg x \deg y} (v \cdot y) \cdot x$. If V

is a left L -module the induced linear map $\varphi : L \rightarrow \text{Hom}(V, V)$ is a morphism of graded Lie algebras, where $\text{Hom}(V, V)$ is given the commutator Lie bracket of Example 1. This is called a *left representation* of L in V .

A *morphism of L -modules* $\alpha : V \rightarrow W$ is a linear map of degree zero such that $\alpha(x \cdot v) = x \cdot \alpha v$, $x \in L$, $v \in V$. Submodules and quotient modules are defined in the obvious way and the *tensor product* of two L -modules is the L -module $V \otimes W$ given by

$$x \cdot (v \otimes w) = x \cdot v \otimes w + (-1)^{\deg x \deg v} v \otimes x \cdot w, \quad x \in L, v \in V, w \in W.$$

Note that there is no tensor product analogue for modules over an associative algebra.

Example 2 *The adjoint representation.*

If L is a graded Lie algebra then a representation $\text{ad} : L \rightarrow \text{Hom}(L, L)$ is defined by

$$(\text{ad } x)(y) = [x, y], \quad x, y \in L.$$

This is called the *adjoint representation*, and (by the Jacobi identity) makes L into an L -module. The submodules are precisely the ideals in L . \square

Example 3 *Derivations.*

Suppose first that A is a graded algebra. The graded space $\text{Der } A$ of derivations of A (§3(b)) is a graded Lie algebra under the commutator $[\alpha, \beta] = \alpha\beta - (-1)^{\deg \alpha \deg \beta} \beta\alpha$. In other words, $\text{Der } A$ is a sub Lie algebra of $\text{Hom}(A, A)$ with the Lie bracket of Example 1.

Now suppose L is a graded Lie algebra. A *derivation* of L of degree k is a linear map $\theta : L \rightarrow L$ of degree k such that $\theta[x, y] = [\theta x, y] + (-1)^{k \deg x} [x, \theta y]$. The derivations of L form a graded sub Lie algebra $\text{Der } L \subset \text{Hom}(L, L)$, again with respect to the commutator.

Note that the Jacobi identity states precisely that each $\text{ad } x$ is a derivation of L . Thus $\text{ad} : L \rightarrow \text{Der } L$. \square

Example 4 *Products.*

The *product* of two graded Lie algebras E and L is the direct sum, $E \oplus L$, with Lie bracket

$$[(x, y), (x', y')] = ([x, x'], [y, y']), \quad \begin{array}{l} x, x' \in E \\ y, y' \in L. \end{array}$$

In particular for $x \in E$, $y \in L$ we have $[x, y] = 0$ in $E \oplus L$. \square

Example 5 *The tensor product, $A \otimes L$.*

Suppose L is a graded Lie algebra and A is a commutative graded algebra. Then $A \otimes L$ is a graded Lie algebra with Lie bracket

$$[a \otimes x, b \otimes y] = (-1)^{\deg b \deg x} ab \otimes [x, y]. \quad \square$$

The rest of this section is organized into the following topics:

- (a) Universal enveloping algebras.
- (b) Graded Hopf algebras.
- (c) Free graded Lie algebras.
- (d) The homotopy Lie algebra of a topological space.
- (e) The homotopy Lie algebra of a minimal Sullivan algebra.
- (f) Differential graded Lie algebras and differential graded Hopf algebras.

(a) Universal enveloping algebras.

Let L be a graded Lie algebra and TL the tensor algebra on the graded vector space, L . Let I be the ideal in the (associative) graded algebra TL generated by the elements of the form $x \otimes y - (-1)^{\deg x \deg y} y \otimes x - [x, y]$, $x, y \in L$. The graded algebra TL/I is called the *universal enveloping algebra* of L and is denoted by UL .

Observe that the inclusion $L \rightarrow TL$ gives a linear map $\iota : L \rightarrow UL$ and that ι is a morphism of Lie algebras with respect to the commutator in UL . Conversely, let $\alpha : L \rightarrow A$ be any linear map into a graded algebra which is a morphism of Lie algebras with respect to the commutator in A , then the extension of α to an algebra morphism $TL \rightarrow A$ annihilates I and so factors to yield a unique morphism of graded algebras

$$\beta : UL \rightarrow A$$

such that $\beta\iota = \alpha$.

In particular a left representation α of L in V determines an algebra morphism $\beta : UL \rightarrow \text{Hom}(V, V)$ such that $\beta\iota = \alpha$. This identifies left L -modules with left modules (in the classical sense) over the universal enveloping algebra. Similarly right L -modules are just right UL -modules.

In the same way if $\varphi : E \rightarrow L$ is a morphism of graded Lie algebras then the composite $E \xrightarrow{\varphi} L \xrightarrow{\iota} UL$ determines a morphism of graded algebras

$$U\varphi : UE \rightarrow UL$$

such that $U\varphi \circ \iota = \iota \circ \varphi$.

Example 1 *Abelian Lie algebras.*

If L is abelian then $UL = TL/(x \otimes y - (-1)^{\deg x \deg y} y \otimes x)$; i.e., UL is the free commutative graded algebra, ΛL , defined in Example 6 of §3(b). □

In general the algebra UL is more complex than ΛL . Nonetheless a fundamental theorem asserts that UL and ΛL are isomorphic as graded vector spaces.

The first form of the theorem is by an explicit comparison of bases. For this we fix a well ordered basis of $L : \{x_\alpha\}_{\alpha \in \mathcal{J}}$. Define an *admissible sequence* M of length k to be a finite (or empty) sequence of indices $\alpha_1, \dots, \alpha_k$ such that $\alpha_1 \leq \alpha_2 \leq \dots \leq \alpha_k$ and such that α_i occurs with multiplicity one if x_{α_i} has odd degree. Define the corresponding *admissible Λ -monomial* to be the element $x_M = x_{\alpha_1} \wedge \dots \wedge x_{\alpha_k} \in \Lambda L$ (or $x_\phi = 1$). Then the admissible Λ -monomials are a basis of ΛL .

Next define the admissible U -monomials to be the elements $u_\phi = 1$ and $u_M = (\iota x_{\alpha_1}) \cdots (\iota x_{\alpha_k}) \in UL$.

Theorem 21.1 (Poincaré-Birkhoff-Witt) *Let L be a graded Lie algebra. Then*

(i) *The admissible U -monomials are a basis of UL .*

(ii) *In particular, the linear map $\iota : L \rightarrow UL$ is an inclusion and extends to an isomorphism of graded vector spaces $\Lambda L \xrightarrow{\cong} UL$.*

proof: [139] If $M = \alpha_1, \dots, \alpha_k$ is admissible then so is $N = \alpha_2, \dots, \alpha_k$ and we write $M = \alpha_1 N$. We show first that an L -module structure in ΛL is defined by the conditions $x_\alpha \cdot x_\phi = x_\alpha$ and, if $M = \alpha_1 N$,

$$x_\alpha \cdot x_M = \begin{cases} x_{\alpha M} & \text{if } \alpha < \alpha_1 \text{ or } \alpha = \alpha_1 \text{ and } \deg x_\alpha \text{ is even.} \\ \frac{1}{2}[x_\alpha, x_{\alpha_1}] \cdot x_N & \text{if } \alpha = \alpha_1 \text{ and } \deg x_\alpha \text{ is odd.} \\ [x_\alpha, x_{\alpha_1}] \cdot x_N + (-1)^{\deg x_\alpha \deg x_{\alpha_1}} x_{\alpha_1} \cdot x_\alpha \cdot x_N & \text{if } \alpha > \alpha_1. \end{cases}$$

Indeed suppose by (transfinite) induction that $x_{\alpha'} \cdot x_{M'}$ is defined if length $M' < \text{length } M$ or if length $M' = \text{length } M$ and $\alpha' < \alpha$. Assume further that $x_{\alpha'} \cdot x_{M'}$ is a linear combination of monomials of length $\leq \text{length } M' + 1$. Then the right hand side of the formula above is defined, and is a linear combination of monomials of length $\leq \text{length } M + 1$. By induction $x_\alpha \cdot x_M$ is defined for all α and M .

To show that this makes ΛL into an L -module we write

$$(\alpha, \beta, M) = [x_\alpha, x_\beta] \cdot x_M - x_\alpha \cdot x_\beta \cdot x_M + (-1)^{\deg x_\alpha \deg x_\beta} x_\beta \cdot x_\alpha \cdot x_M$$

and then verify that $(\alpha, \beta, M) = 0$ for all α, β and M . For this we may clearly suppose $\beta \leq \alpha$ and induct, as before, on length M and on β .

It is immediate from the defining formula that $(\alpha, \beta, \phi) = 0$. Now suppose by induction that $(\alpha', \beta', M') = 0$ if length $M' < \text{length } M$ or if length $M' = \text{length } M$ and $\beta' < \beta$. Write $M = \alpha_1 N$, so that $x_M = x_{\alpha_1} \cdot x_N$. We proceed in four steps.

(i) If $\beta < \alpha_1$ or $\beta = \alpha_1$ and $\deg x_\beta$ is even then $x_\beta \cdot x_M = x_{\beta M}$ and the defining formula gives $(\alpha, \beta, M) = 0$.

(ii) If $\alpha_1 = \beta = \alpha$ and if $\deg x_\beta$ is odd then by our inductive hypothesis on length M ,

$$\begin{aligned} (\beta, \beta, M) &= [x_\beta, x_\beta] \cdot x_\beta \cdot x_N - 2x_\beta \cdot (x_\beta \cdot x_\beta \cdot x_N) \\ &= [x_\beta, x_\beta] \cdot x_\beta \cdot x_N - x_\beta \cdot [x_\beta, x_\beta] \cdot x_N \\ &= [[x_\beta, x_\beta], x_\beta] \cdot x_N. \end{aligned}$$

The Jacobi identity implies $3 [[x_\beta, x_\beta], x_\beta] = 0$, whence $(\beta, \beta, M) = 0$.

(iii) If $\alpha_1 = \beta < \alpha$ then $x_\alpha \cdot x_N$ is a linear combinations of monomials $x_{M'}$ with either length $M' < \text{length } M$ or else $M' = \beta_1 N'$ with $\beta_1 \geq \alpha$. Thus (i) and the inductive hypothesis on length give $x_\beta \cdot x_\beta \cdot x_\alpha \cdot x_N = \frac{1}{2} [x_\beta, x_\beta] \cdot x_\alpha \cdot x_N$. Now a simple calculation using the Jacobi identity and induction on length yields $(\alpha, \beta, M) = 0$.

(iv) Suppose $\beta > \alpha_1$. Use induction on length and the Jacobi identity to verify that (α, β, M) is a linear combination of expressions of the form (β, α_1, M') and (α, α_1, M') with length $M' \leq \text{length } M$. Now the inductive hypothesis implies $(\alpha, \beta, M) = 0$.

This completes the proof that the defining formula above makes ΛL into an L -module. The action of L extends to an algebra morphism $UL \rightarrow \text{Hom}(\Lambda L, \Lambda L)$ and the linear map $UL \rightarrow \Lambda L$ defined by $a \mapsto a \cdot 1$ sends u_M to x_M . Since the x_M are a basis for ΛL the u_M are linearly independent.

On the other hand, UL is generated as an algebra by $\iota(L)$ and hence is linearly spanned by monomials of the form $\iota(x_{\alpha_1}) \cdots \iota(x_{\alpha_k})$ where no restriction is placed on the order of the α_i . However, by construction, we have $\iota(x)\iota(y) - (-1)^{\deg x \deg y} \iota(y)\iota(x) = \iota[x, y]$ and $\iota(x)^2 = \frac{1}{2} \iota([x, x])$ if $|x|$ is odd. It follows that any monomial can be written as a linear combination of an admissible monomial u_M and monomials of shorter length. Induction on monomial length now shows that every element in UL is a linear combination of the u_M ; i.e. the u_M are a basis for UL . \square

Henceforth we shall identify L with its image in UL and drop the notation ' ι '.

If σ is a permutation of k letters and if x_1, \dots, x_k are elements in a graded vector space V then in $\Lambda^k V$ we have $x_1 \wedge \cdots \wedge x_k = \varepsilon x_{\sigma(1)} \wedge \cdots \wedge x_{\sigma(k)}$, where $\varepsilon = \pm 1$ and depends only on σ and the degrees of the x_i . Where the context is clear we abuse notation and denote this sign simply by ε_σ . Recall that S_k denotes the permutation group on k letters.

The following is a useful variant of the Poincaré-Birkhoff-Witt Theorem:

Proposition 21.2 *If L is any graded Lie algebra then a natural linear isomorphism of graded vector spaces,*

$$\gamma : \Lambda L \xrightarrow{\cong} UL$$

is given by $\gamma(x_1 \wedge \cdots \wedge x_k) = \frac{1}{k!} \sum_{\sigma \in S_k} \varepsilon_\sigma x_{\sigma(1)} \cdots x_{\sigma(k)}$.

proof: We adopt the notation of Theorem 21.1 and its proof. Let $UL(k)$ denote the subspace spanned by monomials in L of length $\leq k$. The last part of the proof of 21.1 establishes in fact that the admissible monomials of length $\leq k$ are a basis of $UL(k)$. Moreover, if $x_{\alpha_1} \cdots x_{\alpha_k}$ is an admissible monomial in $UL(k)$ and if σ is any permutation then $x_{\alpha_1} \cdots x_{\alpha_k} - \varepsilon_\sigma x_{\alpha_{\sigma(1)}} \cdots x_{\alpha_{\sigma(k)}} \in UL(k-1)$. Hence for any admissible sequence M of length k , $\gamma(x_M) - u_M \in UL(k-1)$. Since the u_M with M of length k represent a basis of $UL(k)/UL(k-1)$ while the x_M are a basis of $\Lambda^k L$, it follows that γ is an isomorphism. \square

Corollary *If $E \subset L$ is a sub Lie algebra of a graded Lie algebra L then UL is a free left (or right) UE -module.*

proof: Write $L = E \oplus F$ (as graded vector spaces) and identify $\Lambda L = \Lambda E \otimes \Lambda F$. Define $\gamma' : \Lambda E \otimes \Lambda F \rightarrow UL$ by $\gamma'(a \otimes b) = \gamma(a) \cdot \gamma(b)$. The same calculation as in the Proposition shows that $\gamma' - \gamma : \Lambda^k L \rightarrow UL(k-1)$. Hence γ' induces isomorphisms $\Lambda^k L \xrightarrow{\cong} UL(k)/UL(k-1)$, which implies that γ' is an isomorphism.

Since $\gamma(\Lambda E) = UE \subset UL$ it follows that multiplication in UL defines an isomorphism $UE \otimes \gamma(\Lambda F) \xrightarrow{\cong} UL$. This exhibits UL as the free left UE -module on $\gamma(\Lambda F)$. The same argument shows it is a free right UE -module. \square

(b) Graded Hopf algebras.

A *graded Hopf algebra* is a graded vector space G which is simultaneously a graded algebra and (§3(d)) a graded coalgebra (with comultiplication $\Delta : G \rightarrow G \otimes G$ and augmentation $\varepsilon : G \rightarrow \mathbb{k}$), such that both Δ and ε are morphisms of graded algebras. Note that the multiplication in G is automatically a morphism of coalgebras and that $1 \in G_0$ provides the coaugmentation. The Hopf algebra is *cocommutative* if $\tau\Delta = \Delta$ where $\tau(a \otimes b) = (-1)^{\deg a \deg b} b \otimes a$. *Morphisms of graded Hopf algebras* are linear maps of degree zero that preserve all the additional structure.

Suppose G is a Hopf algebra and recall (§3(d)) that an element $x \in G$ is *primitive* if $\Delta x = x \otimes 1 + 1 \otimes x$. If x and y are primitive then so is the commutator bracket $[x, y]$:

$$\begin{aligned} \Delta([x, y]) &= \Delta(xy - (-1)^{\deg x \deg y} yx) \\ &= \Delta x \Delta y - (-1)^{\deg x \deg y} \Delta y \Delta x \\ &= [x \otimes 1 + 1 \otimes x, y \otimes 1 + 1 \otimes y] \\ &= [x, y] \otimes 1 + 1 \otimes [x, y]. \end{aligned}$$

Thus the space $P_*(G)$ of primitive elements is a graded Lie algebra with respect to the commutator bracket.

Conversely, if L is a graded Lie algebra then UL is naturally endowed with the structure of a cocommutative graded Hopf algebra. To define the diagonal we recall first that if E and L are two graded Lie algebras then elements of E commute with those of L in $E \oplus L$ (Example 4). It follows that UE and UL commute inside $U(E \oplus L)$ and so the inclusions extend to morphism of

graded algebras $UE \otimes UL \rightarrow U(E \oplus L)$. On the other hand the Lie morphism $E \oplus L \rightarrow UE \otimes UL$ given by $(x, y) \mapsto x \otimes 1 + 1 \otimes y$ extends to an algebra morphism $U(E \oplus L) \rightarrow UE \otimes UL$. Since these two morphisms reduce to the identity in E and L they are inverse to each other: $U(E \oplus L) = UE \otimes UL$ as graded algebras.

When $E = L$ the diagonal $\delta : L \rightarrow L \oplus L, \delta : x \mapsto (x, x)$ extends to $U\delta : UL \rightarrow U(L \oplus L)$, which we may now write as

$$\Delta : UL \rightarrow UL \otimes UL.$$

Similarly, $\varepsilon : UL \rightarrow \mathbb{k}$ is obtained from the trivial Lie morphism $L \rightarrow 0$. These are both algebra morphisms by construction. From $(\delta \times id)\delta = (id \times \delta)\delta$ we deduce $(\Delta \otimes id)\Delta = (id \otimes \Delta)\Delta$. The identity $(\varepsilon \otimes id)\delta = id = (id \otimes \varepsilon)\delta$ is even easier. Thus $(UL, \Delta, \varepsilon)$ is a graded Hopf algebra. To see that it is cocommutative let $\sigma : L \oplus L \rightarrow L \oplus L$ be the involution $(x, y) \mapsto (y, x)$. Then $\sigma\delta = \delta$ so that $(U\sigma)\Delta = \Delta$. But a trivial check shows that $(U\sigma)(a \otimes b) = (-1)^{\deg a \deg b} b \otimes a$.

Note also that the isomorphism γ of Proposition 21.2 is an isomorphism of graded coalgebras.

Proposition 21.3 *The inclusion $L \rightarrow UL$ is an isomorphism of L onto the graded Lie algebra of primitive elements in UL .*

proof: It is immediate from the definition of UL that the inclusion is a morphism of Lie algebras. To see that it is an isomorphism onto $P_*(UL)$ define a Hopf algebra structure in ΛL with diagonal Δ_Λ the unique algebra morphism given by $\Delta_\Lambda(x) = x \otimes 1 + 1 \otimes x, x \in L$. Since Δ is an algebra morphism a very short computation shows that the linear isomorphism $\gamma : \Lambda L \xrightarrow{\cong} UL$ of Proposition 21.2 is an isomorphism of coalgebras. Thus it is sufficient to prove that L is the primitive subspace of ΛL . Fix a basis $\{x_\alpha\}$ of L . Since Δ_Λ is an algebra morphism, $\Delta_\Lambda(x_{\alpha_1}^{k_1} \wedge \dots \wedge x_{\alpha_r}^{k_r})$ can be expanded easily. In particular it contains a term of the form $k_1 x_\alpha^1 \otimes (x_{\alpha_1}^{k_1-1} \wedge \dots \wedge x_{\alpha_r}^{k_r})$ and this term cannot appear in the diagonal of any other monomial in the $\{x_\alpha\}$. Thus a linear combination of monomials is primitive if and only if they all have length 1; i.e., all primitive elements in ΛL are in L . □

(c) Free graded Lie algebras.

Recall that TV denotes the tensor algebra on a graded vector space V . This is a graded Lie algebra with the commutator bracket. The sub Lie algebra generated by V is called the *free graded Lie algebra on V* and is denoted by \mathbb{L}_V .

This is justified by the appropriate universal property. A linear map $V \rightarrow L$ of degree zero, L a graded Lie algebra, extends uniquely to an algebra morphism $TV \rightarrow UL$. Now L is a sub Lie algebra of UL (Theorem 21.1(ii)) and so this extension restricts to a map $\mathbb{L}_V \rightarrow L$ which is necessarily a morphism of graded Lie algebras.

Note as well that the inclusion $\mathbb{L}_V \rightarrow TV$ extends to an algebra morphism $U\mathbb{L}_V \rightarrow TV$. On the other hand, the inclusions $V \hookrightarrow \mathbb{L}_V \hookrightarrow U\mathbb{L}_V$ extend to

a morphism $TV \rightarrow U\mathbb{L}_V$. Since V generates \mathbb{L}_V as a Lie algebra it generates $U\mathbb{L}_V$ as an algebra. Since these two morphisms reduce to the identity in V they are inverse isomorphisms:

$$TV = U\mathbb{L}_V .$$

Now as usual we say elements in T^kV have *wordlength* k . Analogously, we say that an element in \mathbb{L}_V has *bracket length* k if it is a linear combination of elements of the form $[v_1, \dots, [v_{k-1}, v_k] \dots]$.

Since \mathbb{L}_V is generated by V it is the sum of its subspaces of bracket length k . Since these spaces are contained in T^kV we may deduce that

- $\mathbb{L}_V = \bigoplus_{k \geq 1} (\mathbb{L}_V \cap T^kV)$.
- $x \in \mathbb{L}_V$ has bracket length k if and only if $x \in \mathbb{L}_V \cap T^kV$.

Now let L be any graded Lie algebra and choose any graded subspace $V \subset L$ such that $L = V \oplus [L, L]$. Extend the inclusion of V to a morphism

$$\sigma : \mathbb{L}_V \rightarrow L$$

of graded Lie algebras.

Proposition 21.4 *If $L = \{L_i\}_{i \geq 1}$ then σ is surjective. Moreover the following three conditions are equivalent:*

- (i) σ is an isomorphism.
- (ii) L is free.
- (iii) $\text{proj dim}_{UL}(\mathbb{k}) = 1$ (cf. §20(c)).

proof: Put $E = \sigma(\mathbb{L}_V)$; it is the sub Lie algebra generated by V . Clearly $E + [L, L] = L$. Since $[E, E] \subset E$, substitution gives $E + [L, [L, L]] = L$. Iterating this process gives

$$E + \underbrace{[L, [L, \dots [L, L] \dots,]]}_{k \text{ times}} = L$$

for any k . Since $L = \{L_i\}_{i \geq 1}$ any obvious degree argument gives $E = L$.

It remains to prove the equivalence of (i), (ii) and (iii). Clearly (i) \implies (ii). If (ii) holds then write $L = \mathbb{L}_W$ and $UL = TW$. Let sW be the suspension of $W : (sW)_i = W_{i-1}$. Then the free resolution

$$0 \leftarrow \mathbb{k} \leftarrow TW \xleftarrow{d} sW \otimes TW \leftarrow 0 ,$$

$d(sw \otimes a) = w \otimes a$, shows that $\text{proj dim}_{UL}(\mathbb{k}) = 1$. To show (iii) \implies (i), suppose $\text{proj dim}_{UL}(\mathbb{k}) = 1$. Because $L = \{L_i\}_{i \geq 1}$, \mathbb{k} has a free resolution of the form

$$0 \longleftarrow \mathbb{k} \longleftarrow UL \xleftarrow{d} P_{1,*} \longleftarrow \dots$$

with $P_{1,*} = \{P_{1,i}\}_{i \geq 0}$. Now the proof of Proposition 20.10 provides a projective resolution of the form

$$0 \longleftarrow \mathbb{k} \longleftarrow UL \xleftarrow{d} P \longleftarrow 0$$

with $P \subset P_{1,*}$. Since P is projective it has the form $P = W' \otimes UL$, by the Remark at the start of 20(a). Thus d embeds W' (with a shift of degrees) as a graded subspace $W \subset UL$ and it is a simple exercise to see that $UL = TW$.

Next observe that

$$(UL)_+ = V \oplus (UL)_+ \cdot (UL)_+ .$$

In fact since σ is surjective it follows that $(UL)_+ = V + (UL)_+ \cdot (UL)_+$. On the other hand, denote the abelian Lie algebra $L/[L, L]$ simply by F . Its universal enveloping algebra is just ΛF and the composite map $UL \rightarrow \Lambda F \rightarrow \Lambda F / \Lambda^{\geq 2} F$ kills $(UL)_+ \cdot (UL)_+$ and sends V isomorphically to F . Hence $V \cap (UL)_+ \cdot (UL)_+ = 0$.

Now filter by the wordlength in TW to see that for any subspace V' complementing $(UL)_+ \cdot (UL)_+$ in $(UL)_+$ we have $UL = TV'$. In particular we may choose $V' = V$. Then the identification $UL = UL_V$ is an isomorphism of Hopf algebras and hence restricts to an isomorphism $L \cong \mathbb{L}_V$ of primitive Lie algebras, which is inverse to σ . □

Corollary *If $V = \{V_i\}_{i \geq 1}$ then any sub Lie algebra $L \subset \mathbb{L}_V$ is free.*

proof: As noted in the proof of (ii) \implies (iii) in the Proposition, \mathbb{k} has a UL_V -free resolution of length 2. Since UL_V is a free UL -module, (Corollary to Proposition 21.2) this is a free UL -resolution and $\text{proj dim}_{UL}(\mathbb{k}) = 1$. □

Example *Free products.*

Suppose $\{L(\alpha)\}_{\alpha \in \mathcal{J}}$ is a family of graded Lie algebras. The free product, $\coprod_{\alpha} L(\alpha)$, is the graded Lie algebra L defined as follows: write $V = \bigoplus_{\alpha} L(\alpha)$ and denote by $i_{\alpha}: L(\alpha) \rightarrow V$ the inclusion. Let $I \subset \mathbb{L}_V$ be the ideal generated by the elements $i_{\alpha}[x, y] - [i_{\alpha}x, i_{\alpha}y]$, $x, y \in L(\alpha)$, $\alpha \in \mathcal{J}$. Then $\coprod_{\alpha} L(\alpha) = \mathbb{L}_V / I$.

Note that i_{α} induces a morphism $j_{\alpha}: L(\alpha) \rightarrow \coprod_{\alpha} L(\alpha)$ of graded Lie algebras, and that any family of graded Lie algebra morphisms $\varphi_{\alpha}: L(\alpha) \rightarrow E$ determine a unique morphism $\varphi: \coprod_{\alpha} L(\alpha) \rightarrow E$ such that $\varphi_{\alpha} = \varphi \circ j_{\alpha}$, $\alpha \in \mathcal{J}$. In particular there is a morphism $\varrho_{\alpha}: \coprod_{\alpha} L(\alpha) \rightarrow L(\alpha)$ such that $\varrho_{\alpha} j_{\alpha} = id$ and $\varrho_{\beta} j_{\alpha} = 0$, $\beta \neq \alpha$. Thus each j_{α} is an inclusion.

Next suppose $A(\alpha) = \mathbb{k} \oplus \overline{A}(\alpha)$ are graded associative algebras, with $\overline{A}(\alpha)$ an ideal. We define the free product, $\coprod_{\alpha} \overline{A}(\alpha)$, and show that $U\left(\coprod_{\alpha} L(\alpha)\right) = \coprod_{\alpha} UL(\alpha)$. Indeed, let \mathcal{J} be the set of all finite sequences $\alpha_1, \dots, \alpha_q$ of index elements such that $\alpha_i \neq \alpha_{i+1}$. Set

$$\coprod_{\alpha} A(\alpha) = \mathbb{k} \oplus \bigoplus_{\mathcal{J}} \overline{A}(\alpha_1) \otimes \cdots \otimes \overline{A}(\alpha_q),$$

with the product of $a_1 \otimes \cdots \otimes a_q \in \overline{A}(\alpha_1) \otimes \cdots \otimes \overline{A}(\alpha_q)$ and $b_1 \otimes \cdots \otimes b_r \in \overline{A}(\alpha'_1) \otimes \cdots \otimes \overline{A}(\alpha'_r)$ given by $a_1 \otimes \cdots \otimes a_q b_1 \otimes b_2 \otimes \cdots \otimes b_r$ if $\alpha_q = \alpha'_1$ and by $a_1 \otimes \cdots \otimes a_q \otimes b_1 \otimes \cdots \otimes b_r$ otherwise. Clearly morphisms $\psi_{\alpha} : A(\alpha) \rightarrow B$ of graded associative algebras extend uniquely to a morphism $\coprod_{\alpha} A(\alpha) \rightarrow B$.

Use this, and the analogous universal property for $\coprod_{\alpha} L(\alpha)$ to construct inverse isomorphisms between $U\left(\coprod_{\alpha} L(\alpha)\right)$ and $\coprod_{\alpha} UL(\alpha)$.

Finally, suppose $A = \mathbb{k} \oplus \overline{A}$ and $B = \mathbb{k} \oplus \overline{B}$ are associative graded algebras and that $P_{\bullet} \rightarrow \mathbb{k}$ and $Q_{\bullet} \rightarrow \mathbb{k}$ are respectively an A -free and a B -free resolution beginning with the augmentations $P_0 = A \rightarrow \mathbb{k}$ and $Q_1 = B \rightarrow \mathbb{k}$. Note that $A \amalg B$ is A -free on the direct sum of the subspaces $\overline{B} \otimes \overline{A} \otimes \cdots$ and \mathbb{k} . It follows that

$$P_{\geq 1} \otimes_A (A \amalg B) \xrightarrow{\cong} \overline{A} \otimes_A (A \amalg B)$$

is an $A \amalg B$ -free resolution. Since $A \amalg B = \overline{A} \otimes_A (A \amalg B) \oplus \overline{B} \otimes_B (A \amalg B)$ we obtain an $A \amalg B$ -free resolution of \mathbb{k} of the form

$$[P_{\geq 1} \otimes_A (A \amalg B) \oplus Q_{\geq 1} \otimes_B (A \amalg B)] \rightarrow A \amalg B \rightarrow \mathbb{k}.$$

This yields the formulae

$$\text{Tor}_i^{A \amalg B}(\mathbb{k}, -) = \text{Tor}_i^A(\mathbb{k}, -) \oplus \text{Tor}_i^B(\mathbb{k}, -), \quad i \geq 1$$

and

$$\text{Ext}_{A \amalg B}^i(\mathbb{k}, -) = \text{Ext}_A^i(\mathbb{k}, -) \oplus \text{Ext}_B^i(\mathbb{k}, -), \quad i \geq 1.$$

These apply, in particular, to case that A and B are universal enveloping algebras.

□

(d) The homotopy Lie algebra of a topological space.

Let X be a simply connected topological space. In §16 we defined the loop space homology algebra, $H_*(\Omega X; \mathbb{k})$. Moreover, the Alexander-Whitney diagonal

$$H(\Delta) : H_*(\Omega X; \mathbb{k}) \rightarrow H_*(\Omega X; \mathbb{k}) \otimes H_*(\Omega X; \mathbb{k})$$

is a morphism of graded algebras, as was observed in Lemma 16.3. The map $\Omega X \rightarrow pt$ is trivially product preserving and so the canonical augmentation

$\varepsilon : H_*(\Omega X; \mathbb{k}) \rightarrow \mathbb{k}$ is also a morphism of graded algebras. In other words, *the Alexander-Whitney diagonal and the canonical augmentation make $H_*(\Omega X; \mathbb{k})$ into a graded Hopf algebra.*

On the other hand, recall that since PX is contractible, the connecting homomorphism for the path space fibration is an isomorphism, $\partial_* : \pi_*(X) \xrightarrow{\cong} \pi_{*-1}(\Omega X)$. Thus we may transfer the Whitehead product $[\ ,]_W$ in $\pi_*(X)$ (§13(e)) to a bracket $[\ ,]$ in $\pi_*(\Omega X)$ by setting

$$[\alpha, \beta] = (-1)^{\deg \alpha + 1} \partial_* ([\partial_*^{-1} \alpha, \partial_*^{-1} \beta]_W), \quad \alpha, \beta \in \pi_*(\Omega X).$$

Theorem 21.5 (Milnor-Moore) [127] *If X is a simply connected topological space then*

- (i) *The bracket above makes $\pi_*(\Omega X) \otimes \mathbb{k}$ into a graded Lie algebra (to be denoted by L_X).*
- (ii) *The Hurewicz homomorphism for ΩX is an isomorphism of L_X onto the Lie algebra $P_*(\Omega X; \mathbb{k})$ of primitive elements in $H_*(\Omega X; \mathbb{k})$.*
- (iii) *The Hurewicz homomorphism extends to an isomorphism of graded Hopf algebras,*

$$UL_X \xrightarrow{\cong} H_*(\Omega X; \mathbb{k}).$$

proof: Consider first the case that X has rational homology of finite type. The Cartan-Serre Theorem 16.10 asserts that $hur : \pi_*(\Omega X) \otimes \mathbb{k} \xrightarrow{\cong} P_*(\Omega X; \mathbb{k})$ is a linear isomorphism. Hence a unique Lie structure is induced in $\pi_*(\Omega X) \otimes \mathbb{k}$ such that hur is an isomorphism of Lie algebras. Proposition 16.11 asserts precisely that for $\alpha, \beta \in \pi_*(\Omega X)$,

$$[hur \alpha, hur \beta] = (-1)^{\deg \alpha + 1} hur \partial_* ([\partial_*^{-1} \alpha, \partial_*^{-1} \beta]_W).$$

Thus the induced Lie structure in $\pi_*(\Omega X) \otimes \mathbb{k}$ is given by the required bracket.

This proves (i) and (ii). For assertion (iii) note that, by the definition of universal enveloping algebras, hur extends uniquely to a morphism of graded algebras $\sigma : UL_X \rightarrow H_*(\Omega X; \mathbb{k})$. Theorem 16.13 states precisely that this is an isomorphism. Since L_X is primitive in UL_X (Proposition 21.3) the algebra morphisms $(\sigma \otimes \sigma)\Delta$ and $H(\Delta)\sigma$ agree in L_X . But L_X generates the algebra UL_X . It follows that $(\sigma \otimes \sigma)\Delta = H(\Delta)\sigma$; i.e., σ is an isomorphism of Hopf algebras.

Now consider the general case. A weak homotopy equivalence $X' \rightarrow X$ from a CW complex X' (Theorem 1.4) will induce a weak homotopy equivalence $\Omega X' \rightarrow \Omega X$ (long exact homotopy sequence) and hence a homology isomorphism $H_*(\Omega X'; \mathbb{k}) \xrightarrow{\cong} H_*(\Omega X; \mathbb{k})$ (Theorem 4.15). Thus, given the proof of Theorem 1.4, we may suppose X is a CW complex with a single 0-cell and

no 1-cells. Then any singular chain $c \in C_*(X; \mathbb{k})$ and any continuous map $f : S^n \rightarrow X$ will satisfy $c \in C_*(Y; \mathbb{k})$ and $f(S^n) \subset Y$ for some finite subcomplex $Y \subset X$. If $f : K \rightarrow \Omega X$ is a continuous map from a compact set then all the loops $f(y), y \in K$ have length bounded above by some ℓ . Moreover $\{f(y)(t) \mid 0 \leq t \leq \ell, y \in K\}$ is a compact subset of X and hence contained in some finite complex Y . Thus any singular chain $c \in C_*(\Omega X; \mathbb{k})$ and any continuous map $f : S^n \rightarrow \Omega X$ will satisfy $c \in C_*(\Omega Y; \mathbb{k})$ and $f(S^n) \subset \Omega Y$ for some finite subcomplex $Y \subset X$.

Since the theorem has been proved for finite subcomplexes $Y \subset X$ it follows now in general. □

Definition The graded Lie algebra $L_X = (\pi_*(\Omega X) \otimes \mathbb{k}, [,])$ is called the *homotopy Lie algebra of X with coefficients in \mathbb{k}* . When $\mathbb{k} = \mathbb{Q}$ it is called the *rational homotopy Lie algebra of X* .

Observe that all the constructions above are functorial: if $f : X \rightarrow Y$ is a continuous map between spaces satisfying the hypotheses of Theorem 21.5 then $\pi_*(\Omega f) \otimes \mathbb{k}$ is a morphism of graded Lie algebras and hur is a natural isomorphism.

(e) The homotopy Lie algebra of a minimal Sullivan algebra.

Let $(\Lambda V, d)$ be a minimal Sullivan algebra, as defined in §12. Thus the differential may be written as an infinite sum $d = d_1 + d_2 + \dots$ of derivations, with d_k raising wordlength by k . As observed in §13(e), $(\Lambda V, d_1)$ is itself a minimal Sullivan algebra.

Define a graded vector space L by requiring that

$$sL = \text{Hom}(V, \mathbb{k}) ,$$

where as usual the suspension sL is defined by $(sL)_k = L_{k-1}$. Thus a pairing $\langle ; \rangle : V \times sL \rightarrow \mathbb{k}$ is defined by $\langle v; sx \rangle = (-1)^{\text{deg } v} sx(v)$. Extend this to $(k + 1)$ -linear maps

$$\Lambda^k V \times sL \times \dots \times sL \rightarrow \mathbb{k}$$

by setting

$$\langle v_1 \wedge \dots \wedge v_k; sx_k, \dots, sx_1 \rangle = \sum_{\sigma \in S_k} \varepsilon_\sigma \langle v_{\sigma(1)}; sx_1 \rangle \dots \langle v_{\sigma(k)}; sx_k \rangle,$$

where as usual S_k is the permutation group on k symbols and $v_{\sigma(1)} \wedge \dots \wedge v_{\sigma(k)} = \varepsilon_\sigma v_1 \wedge \dots \wedge v_k$.

Definition A pair of *dual bases* for V and for L consists of a basis (v_i) for V and a basis (x_j) for L such that

$$\langle v_i; sx_j \rangle = \begin{cases} 1 & \text{if } i = j \\ 0 & \text{otherwise.} \end{cases}$$

We observe now that L inherits a Lie bracket $[,]$ from d_1 . Indeed, a bilinear map $[,] : L \times L \rightarrow L$ is uniquely determined by the formula

$$\langle v; s[x, y] \rangle = (-1)^{\deg y + 1} \langle d_1 v; sx, sy \rangle, \quad x, y \in L, v \in V.$$

The relation $v \wedge w = (-1)^{\deg v \deg w} w \wedge v$ leads at once to

$$[x, y] = -(-1)^{\deg x \deg y} [y, x],$$

and an easy computation gives

$$\langle d_1^2 v; sx, sy, sz \rangle = (-1)^{\deg y} \langle v; s[x, [y, z]] - s[[x, y], z] - (-1)^{\deg x \deg y} s[y, [x, z]] \rangle.$$

Thus the Jacobi identity is implied by (indeed is equivalent to) the relation $d_1^2 = 0$.

Definition The Lie algebra L is called the *homotopy Lie algebra* of the Sullivan algebra $(\Lambda V, d)$.

This construction is functorial. If $\varphi : (\Lambda V, d) \rightarrow (\Lambda W, d)$ is a morphism of minimal Sullivan algebras then recall (§12(b)) that $Q(\varphi) : V \rightarrow W$ is the *linear part* of $\varphi : \varphi v - Q(\varphi)v \in \Lambda^{\geq 2} W$. It is immediate that the algebra morphism $\Lambda Q(\varphi) : \Lambda V \rightarrow \Lambda W$ satisfies $\Lambda Q(\varphi) \circ d_1 = d_1 \circ \Lambda Q(\varphi)$.

Now let L and E denote respectively the homotopy Lie algebras of $(\Lambda V, d)$ and $(\Lambda W, d)$. Then $Q(\varphi)$ dualizes to a Lie algebra morphism

$$\omega : L \leftarrow E, \quad \langle v; s\omega x \rangle = \langle Q(\varphi)v; sx \rangle,$$

as follows from the compatibility of $\Lambda Q(\varphi)$ and d_1 .

Finally, suppose X is a simply connected topological space with rational homology of finite type. In §21(d) we defined the homotopy Lie algebra $L_X = \pi_*(\Omega X) \otimes \mathbb{k}$. On the other hand, X has a minimal Sullivan model

$$m : (\Lambda V, d) \rightarrow A_{PL}(X)$$

with its own homotopy Lie algebra L .

Now, by definition, $sL = \text{Hom}(V, \mathbb{k})$. Identify $sL_X = \pi_*(X) \otimes \mathbb{k}$ by setting $s\alpha = -(-1)^{\deg \alpha} \partial_*^{-1} \alpha$, where $\partial_* : \pi_*(X) \xrightarrow{\cong} \pi_{*-1}(\Omega X)$ is the connecting homomorphism for the path space fibration. In §13(c) we used the quasi-isomorphism, m , to define a bilinear map $\langle ; \rangle : V \times \pi_*(X) \rightarrow \mathbb{k}$ (Lemma 13.11). Define a linear map $\theta : \pi_*(X) \otimes \mathbb{k} \rightarrow \text{Hom}(V, \mathbb{k})$ by $(\theta\alpha)v = (-1)^{\deg \alpha} \langle v; \alpha \rangle$.

Theorem 21.6 *The linear map*

$$\sigma : L_X \longrightarrow L$$

defined by $\theta(s\alpha) = \sigma\alpha$, $\alpha \in L_X$, is an isomorphism of graded Lie algebras.

proof: Theorem 15.11 implies that θ is an isomorphism of graded vector spaces. Hence so is σ . To check that σ preserves Lie brackets, recall that if $\alpha, \beta \in L_X$ then their Lie bracket, as defined in §21(d), satisfies

$$\begin{aligned} s[\alpha, \beta] &= -(-1)^{\deg \alpha + \deg \beta} \partial_*^{-1}[\alpha, \beta] \\ &= (-1)^{\deg \beta} [\partial_*^{-1}\alpha, \partial_*^{-1}\beta]_W = (-1)^{\deg \alpha} [s\alpha, s\beta]_W . \end{aligned}$$

On the other hand Proposition 13.16 states that

$$\langle v; [s\alpha, s\beta]_W \rangle = (-1)^{\deg \alpha + \deg \beta + 1} \langle d_1 v; s\alpha, s\beta \rangle, \quad v \in V .$$

Thus the Lie bracket in L_X satisfies

$$\langle d_1 v; s\alpha, s\beta \rangle = (-1)^{\deg \beta + 1} \langle v; s[\alpha, \beta] \rangle ,$$

which is the defining condition for the Lie bracket in L . □

(f) Differential graded Lie algebras and differential graded Hopf algebras.

A *differential graded Lie algebra* (dgl for short) is a graded Lie algebra equipped with a differential d satisfying $d[x, y] = [dx, y] + (-1)^{\deg x} [x, dy]$. Morphisms, subalgebras and ideals have the obvious meaning in the differential context. A *chain Lie algebra* is a dgl in which $L = \{L_i\}_{i \geq 0}$. If $L_0 = 0$, L is a *connected* chain Lie algebra.

A *(left) module* for a dgl, (L, d) is a complex (V, d) together with a (left) representation of L in V such that $d(x \cdot v) = dx \cdot v + (-1)^{\deg x} x \cdot dv$.

Let (L, d) be a dgl. Extend d uniquely to a derivation of square zero in the tensor algebra TL and observe that this preserves the ideal I generated by the elements $x \otimes y - (-1)^{\deg x \deg y} y \otimes x - [x, y]$. Hence the universal enveloping algebra $UL = TL/I$ inherits a differential d , and with it the structure of a differential graded algebra. The differential graded algebra (UL, d) is the *universal enveloping algebra* of the dgl, (L, d) and is often denoted by $U(L, d)$.

Note that (L, d) -modules are precisely the modules over the dga, $U(L, d)$ and so can be treated with the techniques of §6. Note also that if φ is a morphism of dgl's then $U\varphi$ is a morphism of dga's.

As with dga's, the homology $H(L)$ of a dgl inherits the structure of a graded Lie algebra as follows: if z and w are cycles in L representing homology classes α and β , then $[\alpha, \beta]$ is the class represented by the cycle $[z, w]$. If φ is a dgl morphism and if (V, d) is an (L, d) -module then $H(\varphi)$ is a morphism of graded Lie algebras and $[z] \cdot [v] = [z \cdot v]$ makes $H(V)$ into an $H(L)$ -module.

Finally, let (L, d) be a dgl and consider the inclusion $\iota : (L, d) \rightarrow U(L, d)$ as a dgl morphism. Thus $H(\iota) : H(L) \rightarrow H(UL)$ is a Lie morphism with respect to the commutator bracket in the graded algebra $H(UL)$. In particular, it extends to a morphism of graded algebras, $UH(L) \rightarrow H(UL)$.

Theorem 21.7

- (i) *The morphism $UH(L) \rightarrow H(UL)$ is an isomorphism.*
- (ii) *A dgl-morphism φ is a quasi-isomorphism if and only if $U\varphi$ is a quasi-isomorphism.*

proof: (i) Recall the isomorphism $\gamma : \Lambda L \xrightarrow{\cong} UL$ of Proposition 21.2. Extend d to a derivation in ΛL ; then γ is a morphism of complexes. Write $L = Z \oplus V \oplus W$ where $d = 0$ in Z and $d : V \xrightarrow{\cong} W$. Then, as is noted in Lemma 12.5, $H(\Lambda(V \oplus W)) = \mathbb{k}$ and so $(\Lambda Z, 0) \xrightarrow{\cong} (\Lambda L, d)$.

Identify $Z = H(L)$ and observe that $\Lambda Z \xrightarrow[\gamma]{\cong} UH(L) \rightarrow H(UL)$ coincides with the isomorphism $\Lambda Z \xrightarrow{\cong} H(\Lambda L) \xrightarrow[H(\gamma)]{\cong} H(UL)$. Thus $UH(L) \xrightarrow{\cong} H(UL)$.

(ii) The isomorphism of (i) identifies $H(U\varphi)$ with $UH(\varphi)$. But γ identifies $\Lambda H(\varphi)$ with $UH(\varphi)$ and so $H(\varphi)$ is an isomorphism if and only if $UH(\varphi)$ is. □

Finally, we define *differential graded Hopf algebras*: these are simply graded Hopf algebras together with a differential compatible with all the algebraic structure. It is immediate from the definition that $U(L, d)$ is a differential graded Hopf algebra. In §26 we shall see that so as $C_*(\Omega X; \mathbb{k})$ and establish an equivalence (up to homotopy) between $C_*(\Omega X; \mathbb{k})$ and a suitable $U(L, d)$.

Exercises

1. Suppose $x \in L$ and consider $x^2 \in UL$. Prove that $x^2 \in L$. Is it true that $x^k \in L$ for $k \geq 3$?
2. Let L be the quotient of the free Lie algebra $\mathbb{L}(a, b)$ by the ideal generated by the element $[a, [a, b]] \in \mathbb{L}(a, b)$. Prove that if a and b are of even degree then $a^2b + ab^2 = 2a[a, b]$ in UL .
3. Let $L = L' \oplus L''$ be the sum of two graded Lie algebras. Prove that $UL \cong UL' \otimes UL''$.
4. Let $F \rightarrow X \xrightarrow{p} Y$ be a fibration with 1-connected base and fibre. Prove that if $\pi_*(p) \otimes \mathbb{Q}$ is onto then the graded algebra $H_*(\Omega X, \mathbb{Q})$ is isomorphic to $H_*(\Omega Y, \mathbb{Q}) \otimes H_*(\Omega F, \mathbb{Q})$.
5. Compute the homotopy Lie algebra L_X when $X = \mathbb{C}P^n$, $n \geq 2$, $X = S^p \vee S^q$, $X = \mathbb{C}P^p \vee \mathbb{C}P^q$ for $p, q \geq 2$, or $X = \mathbb{C}P^\infty \vee \mathbb{C}P^\infty$. Deduce $H_*(\Omega X, \mathbb{Q})$ in each case.

6. Let (A, d, ϵ) be a differential graded augmented algebra. Deduce from §19-exercise 1 that if A is commutative, then $B(A)$ is a commutative differential graded Hopf algebra with the *shuffle product* defined in §16-exercise 1 and the usual coproduct. Determine the Hopf algebra $B(\mathbb{Z}[x]/(x^2))$ when the degree of x is even.
7. Let (A, ϵ) be a graded augmented algebra. Prove that if A is commutative, then $\text{Tor}_A(\mathbb{Z}, \mathbb{Z})$ is a graded Hopf algebra.
8. Prove that the adjoint representation (example 2) extends to a left representation of L in $\wedge L$ and that the morphism γ of Proposition 2 is L -linear. Deduce that UL is the direct sum of the L -modules $\gamma(\wedge^k L)$, $k = 0, 1, \dots$
9. Let $0 \rightarrow L' \rightarrow L \xrightarrow{f} L'' \rightarrow 0$ be a short exact sequence of graded Lie algebras. Define the *Hopf kernel* of $Uf : UL \rightarrow UL''$ by $HK(f) = \{x \in UL, (id \otimes f)(\Delta x - x \otimes 1) = 0\}$. Prove that $HK(f)$ is isomorphic to UL' and that $UL \cong UL' \otimes UL''$.
10. Let \mathbb{Z} be a commutative ring with unit and ρ be the least prime, if any, which is not a unit in \mathbb{Z} . Prove that $(\rho - 1)!$ is a unit in \mathbb{Z} . Let (L, d) be a differential graded Lie algebra such that $L_i = 0$ for $i < r$. Prove that the natural inclusion $(L, d) \rightarrow (UL, d)$ induces injective maps $H_n(L, d) \rightarrow H_n(UL, d)$ for $n < r\rho$.
11. Let X be a simply connected finite type CW complex. Supposing that $\dim H_*(\Omega X; \mathbb{Q}) < \infty$ and that $H_+(X; \mathbb{Q}) \neq 0$. Prove that X has the rational homotopy type of a finite product of Eilenberg-MacLane spaces of the form $K(\mathbb{Q}, 2n)$.
12. Let V be an n -dimensional \mathbb{Q} -vector space concentrated in degree 2. Using Poincaré-Birkhoff-Witt, compute the dimension of the brackets of length $2r$ in \mathbb{L}_V , for $r \geq 1$.

22 The Quillen functors C_* and \mathcal{L}

In this section the ground ring is a field \mathbb{k} of characteristic zero.

A coalgebra of the form $C = \mathbb{k} \oplus \{C_i\}_{i \geq 2}$ will be called *one-connected*. Such coalgebras are co-augmented by \mathbb{k} . The object of this section is to construct Quillen's functors

$$\begin{array}{ccc} \text{one-connected} & & \\ \text{cocommutative} & \begin{array}{c} \xrightarrow{\mathcal{L}} \\ \xleftarrow{C_*} \end{array} & \text{connected chain} \\ \text{chain coalgebras} & & \text{Lie algebras} \end{array}$$

and to establish the natural quasi-isomorphisms

$$\mathcal{L}(C_*(L, d_L)) \xrightarrow{\cong} (L, d_L) \quad \text{and} \quad C_*(\mathcal{L}(C, d)) \xleftarrow{\cong} (C, d).$$

In §24 we shall see how this correspondence exhibits chain Lie algebras as an alternative description for rational homotopy theory.

The passage from (L, d_L) to $C_*(L, d_L)$ is essentially inverse to the construction of the homotopy Lie algebra of a minimal Sullivan algebra given in §21(d) and we make this remark precise in §23.

This section is organized into the following topics:

- (a) Graded coalgebras.
- (b) The construction of $C_*(L)$ and of $C_*(L; M)$.
- (c) The properties of $C_*(L; UL)$.
- (d) The quasi-isomorphism $C_*(L) \xrightarrow{\cong} BUL$.
- (e) The construction of $\mathcal{L}(C, d)$.
- (f) Free Lie models.

(a) Graded coalgebras.

Recall (§3(d), §19) that a graded coalgebra C is equipped with a comultiplication $\Delta : C \rightarrow C \otimes C$ and an augmentation $\varepsilon : C \rightarrow \mathbb{k}$ and that a co-augmentation is an inclusion $\mathbb{k} \hookrightarrow C$ so that $\varepsilon(1) = 1$ and $\Delta(1) = 1 \otimes 1$. For such a coalgebra we write $\bar{C} = \ker \varepsilon$, so that $C = \mathbb{k} \oplus \bar{C}$.

As described in §19, the reduced comultiplication $\bar{\Delta} : \bar{C} \rightarrow \bar{C} \otimes \bar{C}$ is defined by $\bar{\Delta}c = \Delta c - c \otimes 1 - 1 \otimes c$. Its kernel is the graded subspace of primitive elements. Now set $\bar{\Delta}^{(0)} = id_{\bar{C}}$, $\bar{\Delta}^{(1)} = \bar{\Delta}$ and define the n^{th} reduced diagonal $\bar{\Delta}^{(n)} = (\bar{\Delta} \otimes id \otimes \cdots \otimes id) \circ \bar{\Delta}^{(n-1)} : \bar{C} \rightarrow \bar{C} \otimes \cdots \otimes \bar{C}$ ($n+1$ factors). We say C is *primitively cogenerated* if $\bar{C} = \bigcup_n \ker \bar{\Delta}^{(n)}$. Notice that if $C = \mathbb{k} \oplus C_{>0}$ then C is automatically primitively cogenerated.

Finally, recall that C is cocommutative if $\tau\Delta = \Delta$ where $\tau : C \otimes C \rightarrow C \otimes C$ sends $a \otimes b \mapsto (-1)^{\deg a \deg b} b \otimes a$.

The main example, for us, of such graded coalgebras is the coalgebra ΛV whose comultiplication Δ is the unique morphism of graded algebras such that $\Delta(v) = v \otimes 1 + 1 \otimes v$, $v \in V$. It is augmented by $\varepsilon : \Lambda^+ V \rightarrow 0$, $1 \mapsto 1$ and co-augmented by $\mathbb{k} = \Lambda^0 V$. It is trivially cocommutative. It is also easy to see that $\ker \bar{\Delta}^{(n)} = \Lambda^{\leq n} V$, and so ΛV is primitively cogenerated.

Among the primitively cogenerated, cocommutative coalgebras $(\Lambda V, d)$ has an important universal property. Let $\xi : \Lambda^+ V \rightarrow V$ be the surjection defined by $a - \xi a \in \Lambda^{\geq 2} V$.

Lemma 22.1 *Suppose $C = \mathbb{k} \oplus \bar{C}$ is a primitively cogenerated cocommutative graded coalgebra. Then any linear map of degree zero, $f : \bar{C} \rightarrow V$ lifts to a unique morphism of graded coalgebras, $\varphi : C \rightarrow \Lambda V$ such that $\xi\varphi|_{\bar{C}} = f$.*

proof: Define $f^{(k)} : \bar{C} \otimes \dots \otimes \bar{C} \rightarrow \Lambda^k V$ by

$$f^{(k)}(c_1 \otimes \dots \otimes c_k) = \frac{1}{k!} f(c_1) \wedge \dots \wedge f(c_k).$$

Recall that $\bar{\Delta}^{(0)} = id_{\bar{C}}$ and define φ by $\varphi(1) = 1$ and

$$\varphi c = \sum_{k=0}^{\infty} f^{(k+1)} \bar{\Delta}^{(k)} c, \quad c \in \bar{C}.$$

(Since C is primitively cogenerated, this is a finite sum.)

To verify that φ is a coalgebra morphism, write $\bar{\Delta}^{(k-1)} c = \sum_{\alpha} c_1^{\alpha} \otimes \dots \otimes c_k^{\alpha}$. Co-commutativity implies that $\bar{\Delta}^{(k-1)} c = \sum_{\alpha} \pm c_{\sigma(1)}^{\alpha} \otimes \dots \otimes c_{\sigma(k)}^{\alpha}$, for each permutation, σ .

Co-associativity implies that $\bar{\Delta}^{(k)} = (\bar{\Delta}^{(p)} \otimes \bar{\Delta}^{(q)}) \circ \bar{\Delta}$ for all p, q such that $p + q = k - 1$. Finally, for any $v_i \in V$,

$$\begin{aligned} \Delta(v_1 \wedge \dots \wedge v_k) &= (v_1 \otimes 1 + 1 \otimes v_1) \wedge \dots \wedge (v_k \otimes 1 + 1 \otimes v_k) \\ &= \sum_{p=0}^k \frac{1}{p!} \frac{1}{(k-p)!} \sum_{\sigma \in S_k} \pm v_{\sigma(1)} \wedge \dots \wedge v_{\sigma(p)} \otimes v_{\sigma(p+1)} \wedge \dots \wedge v_{\sigma(k)} \end{aligned}$$

Combining these facts in a straightforward calculation gives $(\varphi \otimes \varphi)\Delta = \Delta\varphi$.

To prove uniqueness observe that any morphism maps $\ker \bar{\Delta}^{(1)}$ into V . Hence if ψ is a second morphism then for $c \in \ker \bar{\Delta}^{(1)}$, $\varphi c = \xi\varphi c = f(c) = \xi\psi c = \psi c$. Suppose φ and ψ agree in $\ker \bar{\Delta}^{(n)}$ and let $c \in \ker \bar{\Delta}^{(n+1)}$. By co-associativity, $\bar{\Delta} c \in \ker \bar{\Delta}^{(n)} \otimes \ker \bar{\Delta}^{(n)}$. Thus $\bar{\Delta}\varphi c = (\varphi \otimes \varphi)\bar{\Delta} c = (\psi \otimes \psi)\bar{\Delta} c = \bar{\Delta}\psi c$. This implies that $(\varphi - \psi)c = (\xi\varphi - \xi\psi)c = 0$. \square

An analogue of Lemma 22.1 also holds for coderivations. Indeed, suppose $g : \Lambda^k V \rightarrow V$ is a linear map of some arbitrary degree, and $k \geq 1$. Define

$\theta_g : \Lambda V \rightarrow \Lambda V$ by

$$\theta_g(v_1 \wedge \cdots \wedge v_n) = \sum_{1 \leq i_1 < \cdots < i_k \leq n} \pm g(v_{i_1} \wedge \cdots \wedge v_{i_k}) \wedge v_1 \wedge \cdots \hat{v}_{i_1} \cdots \hat{v}_{i_k} \cdots \wedge v_n.$$

(Here $\hat{}$ means deleted and \pm is the sign given by $v_1 \wedge \cdots \wedge v_n = \pm v_{i_1} \wedge \cdots \wedge v_{i_k} \wedge v_1 \wedge \cdots \hat{v}_{i_1} \cdots \hat{v}_{i_k} \cdots \wedge v_n$.) Note that θ_g decreases wordlength by $k - 1$.

Lemma 22.2 θ_g is a coderivation in ΛV . It is the unique coderivation that extends g and decreases wordlength by $k - 1$.

proof: The coderivation property is a simple calculation. Uniqueness is proved in the same way as in Lemma 22.1. \square

(b) The construction of $C_*(L)$ and of $C_*(L; M)$.

Let (L, d_L) be a differential graded Lie algebra. The differential and the Lie bracket determine coderivations in ΛsL given explicitly by (Lemma 22.2)

$$d_0(sx_1 \wedge \cdots \wedge sx_k) = - \sum_{i=1}^k (-1)^{n_i} sx_1 \wedge \cdots \wedge sd_L x_i \wedge \cdots \wedge sx_k,$$

and

$$d_1(sx_1 \wedge \cdots \wedge sx_k) = \sum_{1 \leq i < j \leq k} (-1)^{\deg x_i + 1} (-1)^{n_{ij}} s[x_i, x_j] \wedge sx_1 \cdots \hat{s}x_i \cdots \hat{s}x_j \cdots \wedge sx_k.$$

(Here $n_i = \sum_{j < i} \deg sx_j$, and $sx_1 \wedge \cdots \wedge sx_k = (-1)^{n_{ij}} sx_i \wedge sx_j \wedge sx_1 \cdots \hat{s}x_i \cdots \hat{s}x_j \cdots \wedge sx_k$. The symbol $\hat{}$ means ‘deleted’.)

Since d_0 and d_1 are coderivations of odd degree, d_0^2 , $d_0 d_1 + d_1 d_0$ and d_1^2 are also coderivations, decreasing wordlength by 0, 1 and 2 respectively. Moreover

$$d_0^2(sx) = sd_L^2 x = 0;$$

$$(d_0 d_1 + d_1 d_0)(sx \wedge sy) = (-1)^{\deg x} s(d_L[x, y] - [d_L x, y] - (-1)^{\deg x} [x, d_L y]) = 0;$$

$$d_1^2(sx \wedge sy \wedge sz) = (-1)^{\deg y + 1} s([x, [y, z]] - [[x, y], z] - (-1)^{\deg x \deg y} [y, [x, z]]) = 0.$$

Thus by the uniqueness assertion in Lemma 22.2, all three coderivations are zero. In other words, $(\Lambda sL, d = d_0 + d_1)$ is a differential graded coalgebra.

Definition The *Cartan-Eilenberg-Chevalley construction* on a dgl, (L, d_L) is the differential graded coalgebra

$$C_*(L, d_L) = (\Lambda sL, d = d_0 + d_1).$$

We often abuse notation and write simply $C_*(L)$ for $C_*(L, d_L)$.

This construction is functorial: if $\varphi : (E, d_E) \rightarrow (L, d_L)$ is a dgl morphism then $C_*(\varphi)$ is the dgc morphism $\Lambda\bar{\varphi} : \Lambda sE \rightarrow \Lambda sL$, with $\bar{\varphi}(sx) = s\varphi x$.

Remarks 1 The construction $C_*(L)$ is a cocommutative co-augmented and primitively cogenerated coalgebra.

2 For the construction for Lie algebras see Chevalley-Eilenberg [38] and Cartan-Eilenberg [35]; for the differential graded case see Quillen ([135], Appendix B).

3 The reader may have noticed two apparent coincidences: the first between the construction above and the homotopy Lie algebra of a Sullivan model (§21(d)); the second between the construction above and those in §19. These are **not** coincidences. The first will be explained in §23 and the second in §22(d), below. \square

Next, we extend the construction above to the case with coefficients in a graded (L, d_L) -module, (M, d) . Denote the differential in $C_*(L)$ by $\tilde{d} = \tilde{d}_0 + \tilde{d}_1$. Define a complex $(C_*(L; M), d = d_0 + d_1)$ as follows:

- $C_*(L; M) = \Lambda sL \otimes M$ as a graded vector space.
- $d_0 = \tilde{d}_0 \otimes id + id \otimes d$.
- $d_1 = \tilde{d}_1 \otimes id + \theta$, where

$$\theta(sx_1 \wedge \cdots \wedge sx_k \otimes m) = \sum_{i=1}^k (-1)^{n_i} sx_1 \wedge \cdots \wedge \hat{s}x_i \wedge \cdots \wedge sx_k \otimes x_i \cdot m$$

$$\text{and } n_i = \sum_{j=1}^k (\deg x_j + 1) + \sum_{j=i+1}^k (\deg x_i + 1)(\deg x_j + 1).$$

(Note that, as always, the tensor product of linear maps is defined by $(f \otimes g)(a \otimes b) = (-1)^{\deg g \deg a} f(a) \otimes g(b)$.)

As in the case of $C_*(L)$ we have $d_0^2 = d_0 d_1 + d_1 d_0 = d_1^2 = 0$. Indeed $d_0^2 = 0$ because $d^2 = 0$, $d_1 d_0 + d_0 d_1 = 0$ because $d(x \cdot m) = d_L x \cdot m + (-1)^{\deg x} x \cdot dm$ and $d_1^2 = 0$ because $[x, y] \cdot m = x \cdot y \cdot m - (-1)^{\deg x \deg y} y \cdot x \cdot m$.

(c) The properties of $C_*(L; UL)$.

Recall that $(UL, d) = U(L, d_L)$ is the universal enveloping algebra of the dgl (L, d_L) — cf. §21(e). Multiplication from the left makes UL into a left UL -module, and hence into an L -module. Form the complex $C_*(L; UL) = (\Lambda sL \otimes UL, d)$, as described in (b).

Proposition 22.3 *The inclusion $\mathbb{k} \rightarrow (\Lambda sL \otimes UL, d)$ is a quasi-isomorphism.*

Proposition 22.4 *Right multiplication makes $(\Lambda sL \otimes UL, d)$ into a right semifree (UL, d) -module.*

proof of 22.3: In the proof of Proposition 21.2 we introduced the subspaces $UL(n) \subset UL$ spanned linearly by the monomials $x_1 \cdots x_k$, $x_i \in L$, $k \leq n$. We showed there that a linear isomorphism $\gamma : \Lambda L \xrightarrow{\cong} UL$ is given by $x_1 \wedge \cdots \wedge x_k \mapsto \frac{1}{k!} \sum_{\sigma} \varepsilon_{\sigma} x_{\sigma(1)} \cdots x_{\sigma(k)}$, and that it induces isomorphisms $\Lambda^k L \xrightarrow{\cong} UL(k)/UL(k-1)$.

Now write $\Lambda sL \otimes UL$ as the increasing union of the graded subspaces $F_k = \sum_{i+j \leq k} \Lambda^{\leq i} sL \otimes UL(j)$. As usual, identify $\Lambda sL \otimes \Lambda L = \Lambda(sL \oplus L)$. Then

$$id \otimes \gamma : \Lambda^{\leq k}(sL \oplus L) \xrightarrow{\cong} F_k, \quad k \geq 0,$$

and so induces isomorphisms $\Lambda^k(sL \oplus L) \xrightarrow{\cong} F_k/F_{k-1}$.

Next observe that the differential, d , preserves the spaces F_k . Moreover, because $s[x_i, x_j]$ has lower wordlength than $sx_i \wedge sx_j$, the corresponding terms in the formula for d (see (b), above) disappear in F_k/F_{k-1} . Also, $x \cdot \gamma(y_1 \wedge \cdots \wedge y_k) - \gamma(x \wedge y_1 \wedge \cdots \wedge y_k) \in UL(k)$. These comments imply that $id \otimes \gamma$ is an isomorphism of complexes

$$(\Lambda^k(sL \oplus L), \delta) \xrightarrow{\cong} (F_k/F_{k-1}, \bar{d})$$

where δ is the derivation in the algebra $\Lambda(sL \oplus L)$ specified by

$$\delta x = dx \quad \text{and} \quad \delta sx = (-1)^{\deg x + 1} x - sdx, \quad x \in L.$$

Trivially, $H(sL \oplus L, \delta) = 0$. Choose a basis of $sL \oplus L$ of the form $\{u_{\alpha}, \delta u_{\alpha}\}$. Then $\Lambda(sL \oplus L, \delta) \cong \bigotimes_{\alpha} \Lambda(u_{\alpha}, \delta u_{\alpha})$ and so $H(\Lambda(sL \oplus L), \delta) = \mathbb{k}$; i.e.

$H(\Lambda^k(sL \oplus L), \delta) = 0, k \geq 1$. Because of the isomorphism above, $H(F_k/F_{k-1}, \bar{d}) = 0, k \geq 1$. It follows by induction on k that $H(F_k/F_0, \bar{d}) = 0, k \geq 1$, and so $H((\Lambda sL \otimes UL)/\mathbb{k}, d) = 0$, as desired. \square

proof of 22.4: It is immediate from the definitions that multiplication from the right makes $C_*(L; UL) = \Lambda sL \otimes UL$ into a right (UL, d) -module. Moreover, the subspaces $M(k) = \Lambda^{\leq k} sL \otimes UL$ define an increasing family of submodules, and

$$(M(k)/M(k-1), d) \cong (\Lambda^k sL, d_0) \otimes (UL, d).$$

The two step filtration $(\ker d_0) \otimes (UL, d) \subset (\Lambda^k sL, d_0) \otimes (UL, d)$ exhibits $(M(k)/M(k-1), d)$ as (UL, d) -semifree. Now Lemma 6.3 asserts that $C_*(L; UL)$ is (UL, d) -semifree. \square

Notice that the construction $C_*(L; UL)$ is functorial: if $\varphi : (E, d) \rightarrow (L, d)$ is a morphism of dgl's then

$$C_*(\varphi) \otimes U\varphi : (\Lambda sE \otimes UE, d) \rightarrow (\Lambda sL \otimes UL, d)$$

is a morphism of (UE, d) -modules, where UE acts on UL from the right via $U\varphi$. Moreover, because of the acyclicity (Proposition 22.3), $C_*(\varphi) \otimes U\varphi$ is *automatically a quasi-isomorphism*.

Recall from Theorem 21.7 that φ is a quasi-isomorphism if and only if $U\varphi$ is. Using the construction above we prove

Proposition 22.5

- (i) If φ is a quasi-isomorphism then so is $C_*(\varphi)$.
- (ii) If $E = \{E_i\}_{i>0}$ and $L = \{L_i\}_{i>0}$ then φ is a quasi-isomorphism if and only if $C_*(\varphi)$ is a quasi-isomorphism.

proof: (i) Here $U\varphi$ is a quasi-isomorphism (Theorem 21.7) and $C_*(\varphi) \otimes U\varphi$ is a quasi-isomorphism because of Proposition 22.3. Since the modules $C_*(E; UE)$ and $C_*(L; UL)$ are semifree, Theorem 6.10 (ii) asserts that

$$(C_*(\varphi) \otimes U\varphi) \otimes_{U\varphi} \mathbb{k} : (\Lambda sE \otimes UE) \otimes_{UE} \mathbb{k} \rightarrow (\Lambda sL \otimes UL) \otimes_{UL} \mathbb{k}$$

is a quasi-isomorphism. But this is precisely $C_*(\varphi)$.

(ii) Conversely, suppose $C_*(\varphi)$ is a quasi-isomorphism. Consider (UL, d) as a left (UE, d) -module via multiplication on the left by $(U\varphi)a, a \in UE$. Then

$$C_*(\varphi) \otimes id : C_*(E; UL) \rightarrow C_*(L; UL)$$

is a morphism of right semifree (UL, d) -modules. Moreover $(C_*(\varphi) \otimes id) \otimes_{UL} \mathbb{k}$ is the quasi-isomorphism $C_*(\varphi)$. Now Theorem 6.12 asserts (because E and L are concentrated in strictly positive degrees) that $C_*(\varphi) \otimes id$ is a quasi-isomorphism. Hence $H(C_*(E; UL)) = \mathbb{k}$.

Now choose a (UE, d) -semifree resolution of left (UE, d) -modules, $\alpha : (M, d) \xrightarrow{\cong} (UL, d)$, with $M = \{M_i\}_{i \geq 0}$. Since $C_*(E; UE)$ is (UE, d) -semifree, $C_*(E; UE) \otimes_{UE} -$ preserves quasi-isomorphisms. Furthermore, since M is semifree, $- \otimes_{UE} M$ preserves quasi-isomorphisms. Thus

$$\mathbb{k} \otimes_{UE} M \xleftarrow[\cong]{\varepsilon \otimes id} C_*(E; UE) \otimes_{UE} M \xrightarrow[\cong]{id \otimes \alpha} C_*(E; UE) \otimes_{UE} UL = C_*(E; UL);$$

i.e. $H(\mathbb{k} \otimes_{UE} M) = \mathbb{k}$.

Define $\beta : (UE, d) \rightarrow (M, d)$ by $\beta a = a \cdot m$, where m is a cycle in M_0 such that $H(\alpha)[m] = 1$. The calculation $H(\mathbb{k} \otimes_{UE} M) = \mathbb{k}$ shows that $\mathbb{k} \otimes_{UE} \beta$ is a quasi-isomorphism, and hence so is β , again by Theorem 6.12. Moreover, $H(\alpha)$ is an isomorphism by construction. Thus $H(U\varphi) = H(\alpha) \circ H(\beta)$ is an isomorphism. Now Theorem 21.7 asserts that φ is a quasi-isomorphism. \square

We now return to the construction $C_*(L; UL)$. Recall from (a) above that ΛsL is a cocommutative graded coalgebra and from §21(e) that (UL, d) is a differential graded Hopf algebra.

Proposition 22.6

- (i) *The tensor product of the diagonals in ΛsL and in UL makes $C_*(L; UL)$ into a differential graded coalgebra.*
- (ii) *The linear isomorphism $\gamma : \Lambda L \xrightarrow{\cong} UL$ of Proposition 21.2 is an isomorphism of coalgebras. Hence $C_*(L; UL) \cong \Lambda sL \otimes \Lambda L$ as a graded coalgebras.*
- (iii) *The module action $(\Lambda sL \otimes UL, d) \otimes (UL, d) \rightarrow (\Lambda sL \otimes UL, d)$ is a morphism of graded coalgebras.*
- (iv) *The quotient map $- \otimes_{UL} \mathbb{k} : (\Lambda sL \otimes UL, d) \rightarrow (\Lambda sL, d)$ is a morphism of graded coalgebras.*

proof: The tensor product of the diagonals in ΛsL and in UL certainly makes $\Lambda sL \otimes UL$ into a graded coalgebra. Moreover the isomorphism $\gamma : \Lambda L \xrightarrow{\cong} UL$ of Proposition 21.2 is an isomorphism of graded coalgebras, as follows from the relation

$$\Delta_{UL}(x_1 \cdots x_n) = (x_1 \otimes 1 + 1 \otimes x_1) \cdots (x_k \otimes 1 + 1 \otimes x_k), \quad x_i \in L.$$

To show that the differential is a coderivation denote the differentials in $\Lambda sL = C_*(L)$ by \bar{d}_0 and \bar{d}_1 ; they are both coderivations. Since d is a coderivation in UL (§21(e)) it follows that $d_0 = \bar{d}_0 \otimes id + id \otimes d$ is a coderivation. Moreover, recall that $d_1 = \bar{d}_1 \otimes 1 + \theta$ where \bar{d}_1 is a coderivation and $\theta(sx_1 \wedge \cdots \wedge sx_k \otimes a) = \sum \pm sx_1 \cdots s\hat{x}_i \cdots sx_k \otimes x_i a$. Since Δ_{UL} is an algebra morphism, $\Delta_{UL}(x_i a) = (x_i \otimes 1 + 1 \otimes x_i) \Delta_{UL} a$. This implies (after a short calculation) that θ is a coderivation.

The remaining assertions are self-evident. □

(d) The quasi-isomorphism $C_*(L) \xrightarrow{\cong} BUL$.

As we observed earlier, the constructions $C_*(L)$ and $C_*(L; M)$ bear a strong similarity to the bar constructions of §19. We can now make this precise.

Let (L, d) be a dgl and denote by BUL the bar construction on the dga (UL, d) . As in §19, $B(UL; UL)$ denotes the bar construction with coefficients in UL , where UL acts on itself via left multiplication.

Now BUL is the tensor coalgebra $Ts\overline{UL}$ on the suspension of the augmentation ideal $\overline{UL} \subset UL$. The inclusion $L \subset UL$ (§21(a)) has its image in \overline{UL} ; hence we may regard sL as a subspace of $s\overline{UL}$.

Proposition 22.7 *A natural dgc quasi-isomorphism*

$$\lambda : C_*(L) \xrightarrow{\cong} BUL$$

is given by $\lambda : sx_1 \wedge \cdots \wedge sx_k \mapsto \sum_{\sigma \in S_k} \varepsilon_\sigma [sx_{\sigma(1)} | \cdots | sx_{\sigma(k)}]$, where $sx_1 \wedge \cdots \wedge sx_k = \varepsilon_\sigma sx_{\sigma(1)} \wedge \cdots \wedge sx_{\sigma(k)}$.

proof: A straightforward, if tedious, calculation verifies that λ is a morphism of dgc's. Similarly,

$$\lambda \otimes id : (\Lambda sL \otimes UL, d) \longrightarrow (BUL \otimes UL, d)$$

is a morphism of (UL, d) -modules. According to Proposition 19.2, $H(BUL \otimes UL) = \mathbb{k}$ and $(BUL \otimes UL, d)$ is (UL, d) -semifree. According to Propositions 22.3 and 22.4, $(\Lambda sL \otimes UL, d)$ has the same two properties.

Because $H(BUL \otimes UL) = \mathbb{k} = H(\Lambda sL \otimes UL)$, $\lambda \otimes id$ is necessarily a quasi-isomorphism. Because both are (UL, d) -semifree, Proposition 6.7 (ii) asserts that $(\lambda \otimes id) \otimes_{UL} \mathbb{k}$ is a quasi-isomorphism. But, trivially, $(\lambda \otimes id) \otimes_{UL} \mathbb{k} = \lambda$. \square .

Remark Proposition 22.7 replaces the huge complex $T(s^{-1}\overline{UL})$ by the relatively small complex ΛsL , which is a major computational advance. In the classical case of ungraded Lie algebras without differentials, the smaller complex in fact came first, as the dual of the left invariant forms on a Lie group. The bar construction and the equivalence of Proposition 22.7 appear later in [118] and [35].

(e) The construction $\mathcal{L}(C, d)$.

Recall that the free graded Lie algebra \mathbb{L}_V is the sub Lie algebra of TV generated by V (§21(c)) and that TV is the universal enveloping algebra of \mathbb{L}_V . Thus a dgl of the form (\mathbb{L}_V, d) will be called a *free dgl*. Note that this is a *serious abuse of language*: (\mathbb{L}_V, d) is almost never a free object in the category of dgl's.

Recall first some basic facts about free Lie algebras \mathbb{L}_V (cf. §21(c)). First, \mathbb{L}_V is the direct sum of the subspaces $\mathbb{L}_V^{(i)}$ of bracket length i , and $L_V^{(1)} = V$. Second, any linear map $f : V \rightarrow L$ (L a graded Lie algebra) extends uniquely to an algebra morphism $TV \rightarrow UL$, which then restricts to a Lie morphism $\mathbb{L}_V \rightarrow L$, the unique extension of f . Finally any linear map $g : V \rightarrow \mathbb{L}_V$ extends uniquely to a derivation θ of TV which then restricts to the derivation of \mathbb{L}_V uniquely extending g .

Let (\mathbb{L}_V, d) be a free dgl. The *linear part* of the differential d is the differential $d_V : V \rightarrow V$ defined by $dv - d_V v \in \bigoplus_{k \geq 2} \mathbb{L}_V^{(k)}$. It suspends to a differential \bar{d} in

$$sV : \bar{d}sv = -sd_V v.$$

Now consider the composite

$$\varrho : C_*(\mathbb{L}_V) = \Lambda s\mathbb{L}_V \longrightarrow s\mathbb{L}_V \oplus \mathbb{k} \longrightarrow sV \oplus \mathbb{k},$$

where we have first annihilated $\Lambda^{\geq 2} s\mathbb{L}_V$ and then $s(\mathbb{L}_V^{(\geq 2)})$.

Proposition 22.8 *The linear map ϱ is a natural quasi-isomorphism of complexes,*

$$(C_*(\mathbb{L}_V), d) \xrightarrow{\sim} (sV \oplus \mathbb{k}, \bar{d}).$$

proof: It is immediate from the definitions that ϱ commutes with the differentials. Moreover, since $UL_V = TV$, there is an analogous morphism $\varrho' : (BU\mathbb{L}_V, d) \rightarrow (sV \oplus \mathbb{k}, \bar{d})$ constructed in §19 just before Proposition 19.1. Moreover, Proposition 19.1 asserts that ϱ' is a quasi-isomorphism.

It is immediate that the quasi-isomorphism of Proposition 22.7, $\lambda : C_*(\mathbb{L}_V) \xrightarrow{\cong} BU\mathbb{L}_V$, satisfies $\varrho'\lambda = \varrho$. Thus ϱ is a quasi-isomorphism. \square

A prime (but by no means the only) way of constructing free dgl's is through Quillen's functor, \mathcal{L} , which is the analogue here of the cobar construction. The functor \mathcal{L} is constructed as follows. Let $(C, d) = (\bar{C}, d) \oplus \mathbb{k}$ be any co-augmented dgc, which is *cocommutative*. Form the cobar construction, $\Omega C = Ts^{-1}\bar{C}$, as described in §19. The differential has the form $d = d_0 + d_1$ with d_0 preserving $s^{-1}\bar{C}$ and $d_1 : s^{-1}\bar{C} \rightarrow s^{-1}\bar{C} \otimes s^{-1}\bar{C}$. Moreover, because C is cocommutative, we can express $d_1(s^{-1}c)$ as a sum of commutators in the tensor algebra $Ts^{-1}\bar{C}$. Indeed, write $\bar{\Delta}c = \sum a_i \otimes b_i$. Then also $\bar{\Delta}c = \sum (-1)^{\deg a_i \deg b_i} b_i \otimes a_i$. Hence

$$\begin{aligned} d_1(s^{-1}c) &= \frac{1}{2} \sum_i (-1)^{\deg a_i} (s^{-1}a_i \otimes s^{-1}b_i - \\ &\quad (-1)^{(\deg a_i - 1)(\deg b_i - 1)} s^{-1}b_i \otimes s^{-1}a_i) \\ &= \frac{1}{2} \sum_i (-1)^{\deg a_i} [s^{-1}a_i, s^{-1}b_i]. \end{aligned}$$

This shows that $d_1 : s^{-1}\bar{C} \rightarrow \mathbb{L}_{s^{-1}\bar{C}} \subset T(s^{-1}\bar{C})$. Because d_1 is, in particular, a Lie derivation it preserves $\mathbb{L}_{s^{-1}\bar{C}}$. Hence so does d ; i.e., $(\mathbb{L}_{s^{-1}\bar{C}}, d)$ is a dgl with universal enveloping algebra ΩC .

This construction is obviously functorial.

Definition The dgl $(\mathbb{L}_{s^{-1}\bar{C}}, d)$ will be called the *Quillen construction* on the co-augmented cocommutative dgc, (C, d) and will be denoted by $\mathcal{L}(C, d)$.

Theorem 22.9 Suppose $(L = \{L_i\}_{i \geq 1}, d)$ is a connected chain Lie algebra and $(C = \mathbb{k} \oplus C_{\geq 2}, d)$ is a cocommutative dgc. Then there are natural quasi-isomorphisms

$$\varphi : (C, d) \xrightarrow{\cong} C_*\mathcal{L}(C, d) \quad \text{and} \quad \psi : \mathcal{L}C_*(L, d) \xrightarrow{\cong} (L, d)$$

of dgc's (respectively, of dgl's).

proof: (i) *Existence of φ .* Write $\bar{C} = C_{\geq 2}$. Thus $\mathcal{L}(C, d) = \mathbb{L}_{s^{-1}\bar{C}}$ and $C_*(\mathbb{L}_{s^{-1}\bar{C}}) = \Lambda s\mathbb{L}_{s^{-1}\bar{C}}$. Thus by Proposition 22.8 we have a quasi-isomorphism of complexes,

$$\varrho : C_*(\mathbb{L}_{s^{-1}\bar{C}}) \rightarrow (ss^{-1}\bar{C} \oplus \mathbb{k}, \bar{d}).$$

Now $ss^{-1}\bar{C} = \bar{C}$, and a quick inspection shows that \bar{d} is the original differential in C :

$$\varrho : C_*(\mathbb{L}_{s^{-1}\bar{C}}) \xrightarrow{\cong} (C, d).$$

However, ϱ is **not** a coalgebra morphism. To obtain one, apply Lemma 22.1 to the inclusion

$$f : \bar{C} = ss^{-1}\bar{C} \subset s\mathbb{L}_{s^{-1}\bar{C}} \subset \Lambda s\mathbb{L}_{s^{-1}\bar{C}},$$

noting that C is trivially primitively cogenerated because $\bar{C} = \{\bar{C}_i\}_{i \geq 2}$. This gives a unique morphism $\varphi : C \rightarrow \Lambda s\mathbb{L}_{s^{-1}\bar{C}}$ of coalgebras such that $(\varphi - f)(\bar{C}) \subset \Lambda^{\geq 2}$. We show first that φ is a dgc morphism, and then that it is a quasi-isomorphism.

For simplicity, write $L = \mathbb{L}_{s^{-1}\bar{C}}$ and denote the differentials in L by $\partial = \partial_0 + \partial_1$ with $\partial_0 s^{-1}c = -s^{-1}dc$ and ∂_1 reflecting the diagonal. Then write $\varphi = \sum \varphi_i$ where $\varphi_i : C \rightarrow \Lambda^i sL$ is the component of wordlength i . Let $\xi : \Lambda^+ sL \rightarrow sL$ be the projection with kernel $\Lambda^{\geq 2} sL$.

Now observe that $\xi(\varphi d - d\varphi) = 0$ or, equivalently, that $\varphi_1 d = d_0 \varphi_1 + d_1 \varphi_2$. Indeed, $d_0 \varphi_1 c = d_0(ss^{-1}c) = -s\partial_0 s^{-1}c$. In defining $\mathcal{L}(C, d)$ we gave an explicit formula for dsc . Thus if, $\bar{\Delta}c = \sum c_i \otimes c'_i$, then

$$d_0 \varphi_1 c = ss^{-1}dc = \frac{1}{2} \sum_i (-1)^{\deg c_i} s[s^{-1}c_i, s^{-1}c'_i].$$

On the other hand, $\varphi_1 dc = ss^{-1}dc$ and (cf. Lemma 22.1)

$$\begin{aligned} d_1 \varphi_2 c &= d_1 \left(\frac{1}{2} \sum_i ss^{-1}c_i \wedge ss^{-1}c'_i \right) \\ &= \frac{1}{2} \sum_i (-1)^{\deg(ss^{-1}c_i)} s[s^{-1}c_i, s^{-1}c'_i]. \end{aligned}$$

It follows that $\varphi_1 d = d_0 \varphi_1 + d_1 \varphi_2$.

Put $\theta = \varphi d - d\varphi$. We have just seen that $\xi\theta = 0$. The coderivation property implies that $(\theta \otimes \varphi + \varphi \otimes \theta)\bar{\Delta} = \bar{\Delta}\theta$, where $\bar{\Delta}$ denotes both reduced diagonals. By coassociativity, $\bar{\Delta} : \ker \bar{\Delta}^{(n)} \rightarrow \ker \bar{\Delta}^{(n-1)} \otimes \ker \bar{\Delta}^{(n-1)}$, where $\bar{\Delta}^{(n)}$ is the n^{th} reduced diagonal as defined in §22(a). Assume by induction that θ vanishes on $\ker \bar{\Delta}^{(n-1)}$. Then for $c \in \ker \bar{\Delta}^{(n)}$, $\bar{\Delta}\theta c = 0$ and $\theta c = \xi\theta c = 0$. It follows by induction that $\theta = 0$; i.e. $\varphi d = d\varphi$.

Finally, note that $\varrho\varphi = id$. Since ϱ is a quasi-isomorphism, so is φ .

(ii) *Existence of ψ .* Put $C = C_*(L)$ so that $\bar{C} = \Lambda^+ sL$. Define $\sigma : s^{-1}\bar{C} \rightarrow L$ by setting $\sigma(s^{-1}sx) = x$ and $\sigma(s^{-1}a) = 0$, $a \in \Lambda^{\geq 2} sL$. Then since $\mathbb{L}_{s^{-1}\bar{C}}$ is a free Lie algebra, σ extends to a unique Lie morphism $\psi : \mathbb{L}_{s^{-1}\bar{C}} \rightarrow L$. As in (i) we have to check that ψ commutes with the differentials and that $H(\psi)$ is an isomorphism.

The linear map $\theta = \psi d - d\psi$ satisfies $\theta[a, b] = [\theta a, \psi b] + (-1)^{\deg a}[\psi a, \theta b]$, $a, b \in \mathbb{L}_{s^{-1}\bar{C}}$. Since this Lie algebra is generated by $s^{-1}\bar{C}$ it is enough to check that θ vanishes there. This is a straightforward computation from the definition of the differentials, as in (i).

Let $\varphi : C_*(L) \xrightarrow{\cong} C_*\mathbb{L}_{s-1}\overline{C}$ be the dgc quasi-isomorphism constructed in part (i) of the theorem (for general cocommutative dgc's). A quick computation shows that $C_*(\psi)\varphi = id$. Hence $C_*(\psi)$ is a quasi-isomorphism, and then so is ψ by Proposition 22.5. \square

Corollary *Suppose $\alpha : (C, d) \rightarrow (C', d)$ is a morphism between dgc's satisfying the hypotheses of the theorem. Then α is a quasi-isomorphism if and only if $\mathcal{L}(\alpha)$ is.*

proof: The theorem identifies $H(\alpha)$ with $H(C_*\mathcal{L}(\alpha))$. Now apply Proposition 22.5. \square

(f) Free Lie models.

In §22(e) we introduced the free dgl's (\mathbb{L}_V, d) . Thus (\mathbb{L}_V, d) is a connected chain Lie algebra precisely when $V = \{V_i\}_{i \geq 1}$. These play the same role within the category of connected chain Lie algebras that Sullivan algebras play in the category of commutative cochain algebras, and for the same reason: the underlying algebraic object is free.

In particular we make the

Definition A *free model* of a connected chain Lie algebra (L, d) is a dgl quasi-isomorphism of the form

$$m : (\mathbb{L}_V, d) \xrightarrow{\cong} (L, d)$$

with $V = \{V_i\}_{i \geq 1}$.

$$\psi : \mathcal{L}C_*(L, d) \xrightarrow{\cong} (L, d) .$$

There is a simpler approach, however, which extends any morphism $\gamma : (\mathbb{L}_W, d) \rightarrow (L, d)$ of connected chain Lie algebras to a free model: (λ is the obvious inclusion)

$$\begin{array}{ccc}
 (\mathbb{L}_{W \oplus V}, d) & \xrightarrow[\cong]{m} & (L, d) \\
 \swarrow \lambda & & \nearrow \gamma \\
 & (\mathbb{L}_W, d) &
 \end{array}
 \tag{22.10}$$

Indeed, suppose for some $r \geq 0$ that $H_i(\gamma)$ is an isomorphism for $i < r$ and surjective for $i = r$. Extend γ to

$$\gamma' : (\mathbb{L}_{W \oplus V_{r+1}}, d) \rightarrow (L, d)$$

by requiring that

- $V_{r+1} = V'_{r+1} \oplus V''_{r+1}$.

- The elements $dv, v \in V'_{r+1}$, are cycles in \mathbb{L}_W representing all the classes in $\ker H_r(\gamma)$.
- The elements in V''_{r+1} are cycles and are mapped by γ to cycles representing all the elements in $\text{coker } H_{r+1}(\gamma)$.

Then $H_i(\gamma')$ is an isomorphism for $i \leq r$ and surjective for $i = r + 1$. Iterate this procedure to construct (22.10). □

Free Lie models of the form (22.10) are analogues of the relative Sullivan models of §14. This motivates the

Definition A *free Lie extension* is a morphism $\lambda : (\mathbb{L}_W, d) \rightarrow (\mathbb{L}_{W \oplus V}, d)$ of free connected chain Lie algebras, in which λ is the obvious inclusion.

Suppose now given a commutative diagram

$$\begin{array}{ccc}
 (\mathbb{L}_W, d) & \xrightarrow{\alpha} & (E, d) \\
 \lambda \downarrow & & \simeq \downarrow \xi \\
 (\mathbb{L}_{W \oplus V}, d) & \xrightarrow{\beta} & (L, d)
 \end{array}$$

of morphisms of connected chain Lie algebras. Assume λ is a free extension and ξ is a surjective quasi-isomorphism.

Proposition 22.11 *With these hypotheses α extends to a morphism $\varphi : (\mathbb{L}_{W \oplus V}, d) \rightarrow (E, d)$ such that $\xi\varphi = \beta$.*

proof: Identical with that of Lemma 12.4, except that the induction is in the degree of the elements in W . □

Suppose next that (\mathbb{L}_V, d) is a free connected chain Lie algebra. Then d decomposes uniquely as the sum of derivations $d_i : V \rightarrow \mathbb{L}_V^{(i+1)}$. The differential $d_0 : V \rightarrow V$ is the linear part of d , as defined in (e) above.

Similarly, if $\varphi : (\mathbb{L}_W, d) \rightarrow (\mathbb{L}_V, d)$ is a morphism of free connected chain Lie algebras then the *linear part of φ* is the chain complex morphism

$$\varphi_0 : (W, d_0) \rightarrow (V, d_0)$$

defined by $\varphi - \varphi_0 : W \rightarrow \mathbb{L}_V^{(\geq 2)}$.

Proposition 22.12 *If $\varphi : (\mathbb{L}_W, d) \rightarrow (\mathbb{L}_V, d)$ is a morphism of free connected chain Lie algebras then*

$$\varphi \text{ is a quasi-isomorphism} \iff \varphi_0 \text{ is a quasi-isomorphism.}$$

proof: According to Proposition 22.5 and Proposition 22.8 respectively,

$$\begin{aligned} \varphi \text{ is a quasi-isomorphism} &\iff C_*(\varphi) \text{ is a quasi-isomorphism} \\ &\iff \varphi_0 \text{ is a quasi-isomorphism.} \end{aligned} \quad \square$$

Definition A free connected chain Lie algebra (\mathbb{L}_V, d) is *minimal* if the linear part d_0 of the differential is zero. In this case a quasi-isomorphism

$$m : (\mathbb{L}_V, d) \xrightarrow{\cong} (L, d)$$

is called a *minimal free Lie model*.

Theorem 22.13 *Every connected chain algebra (L, d) admits a minimal free Lie model*

$$m : (\mathbb{L}_V, d) \xrightarrow{\cong} (L, d)$$

and (\mathbb{L}_V, d) is unique up to isomorphism.

proof: Theorem 22.9 provides a surjective free model, which we write as

$$\psi : (\mathbb{L}_W, d) \xrightarrow{\cong} (L, d) .$$

Decompose $W = V \oplus U \oplus d_0U$ with $d_0 = 0$ in V and $d_0 : U \xrightarrow{\cong} d_0U$.

Next, let $I \subset \mathbb{L}_W$ be the Lie ideal generated by U and by dU . Thus I is preserved by d and $(\mathbb{L}_W/I, \bar{d})$ is a quotient connected chain Lie algebra. Denote the quotient map by $\varrho : (\mathbb{L}_W, d) \rightarrow (\mathbb{L}_W/I, \bar{d})$.

It is an elementary exercise in algebra to verify that the inclusions of V , dU and U into \mathbb{L}_W extend to an isomorphism $T(V \oplus dU \oplus U) \xrightarrow{\cong} TW$ (filter by the ideals $T^{\geq k}$). Hence $\mathbb{L}_W = \mathbb{L}_V \oplus I$ and ϱ restricts to an isomorphism $\mathbb{L}_V \xrightarrow{\cong} \mathbb{L}_W/I$. Use this to identify $(\mathbb{L}_W/I, \bar{d})$ as a free chain Lie algebra (\mathbb{L}_V, \bar{d}) .

It is straightforward to check that the linear part of ϱ is the linear map $\varrho_0 : W \rightarrow V$ which is the identity on V and zero in U and d_0U . Since $d_0\varrho_0v = \varrho_0d_0v = 0$ it follows that (\mathbb{L}_V, \bar{d}) is minimal. Moreover $H(\varrho_0)$ is an isomorphism and hence ϱ is a quasi-isomorphism (Proposition 22.12). Finally, Proposition 22.11 allows us to lift $id_{\mathbb{L}_V}$ through ϱ to obtain $\sigma : (\mathbb{L}_V, \bar{d}) \rightarrow (\mathbb{L}_W, d)$ such that $\varrho\sigma = id$. Then

$$m = \psi\sigma : (\mathbb{L}_V, \bar{d}) \xrightarrow{\cong} (L, d)$$

is a minimal Lie model.

For uniqueness, let $m' : (\mathbb{L}_{V'}, d') \xrightarrow{\cong} (L, d)$ be any other minimal Lie model. Lift m' through the surjective quasi-isomorphism ψ , and compose with ϱ . This gives a quasi-isomorphism

$$\varphi : (\mathbb{L}_{V'}, d') \xrightarrow{\cong} (\mathbb{L}_V, \bar{d})$$

between minimal free connected chain Lie algebras.

Now Proposition 22.12 asserts that $H(\varphi_0)$ is an isomorphism. But d_0 and d'_0 are zero, so φ_0 itself is an isomorphism. Now apply Proposition 22.12 to $\varphi : (\mathbb{L}_{V'}, 0) \rightarrow (\mathbb{L}_V, 0)$ to conclude that φ is an isomorphism. \square

Notice that the last paragraph of the proof of Theorem 22.13 in fact establishes

Proposition 22.14 *A quasi-isomorphism between minimal free connected chain Lie algebras is an isomorphism.* \square

Exercises

1. Prove that if $\deg v = 2n - 1$, $n \geq 1$, then $\varphi : T(v) \rightarrow \wedge v \otimes T(u)$ defined by $\varphi(v^{2k+1}) = v \otimes u^k$ and $\varphi(v^{2k}) = 1 \otimes u^k$ is an isomorphism of coalgebras (see §3-exercise 4). Deduce that

$$H_*(\Omega S^{2n}; \mathbb{Q}) = H_*(S^n; \mathbb{Q}) \otimes H_*(\Omega S^{4n-1}; \mathbb{Q}).$$

2. Let $\varphi, \psi : (\mathbb{L}_V, d) \rightarrow (L, d)$ be two morphisms of differential graded algebras. A degree k -linear map $\theta : \mathbb{L}_V \rightarrow L$ is an (φ, ψ) -derivation if it satisfies $\theta([x, y]) = [\theta x, \psi y] + (-1)^{\deg x} [\varphi x, \theta y]$. We write $\varphi \simeq \psi$ if there exists an (φ, ψ) -derivation of degree 1 satisfying $[\theta, d] = \varphi - \psi$. Prove that \simeq is an equivalence relation.

23 The commutative cochain algebra, $C^*(L, d_L)$

In this section the ground ring is a field \mathbb{k} of characteristic zero. In particular, we write $H_*(-)$ and $H^*(-)$ for $H_*(-; \mathbb{k})$ and $H^*(-; \mathbb{k})$.

In §22 we constructed the dgc $C_*(L, d_L)$ associated with a dgl, (L, d_L) . Here we dualize that construction to obtain a commutative differential graded algebra, $C^*(L, d_L)$.

When L is a chain Lie algebra, $C^*(L, d_L)$ is a cochain algebra, and so the full Sullivan machinery of Part II may be applied. In particular we can use chain Lie algebras (L, d_L) to model topological spaces X by requiring that $C^*(L, d_L)$ be a model for $A_{PL}(X)$. This is carried out in §24.

This section is organized into the topics

- (a) The constructions $C^*(L, d_L)$ and $\mathcal{L}_{(A, d)}$.
- (b) The homotopy Lie algebra and the Milnor-Moore spectral sequence.
- (c) Cohomology with coefficients.

(a) The constructions $C^*(L, d_L)$, and $\mathcal{L}_{(A, d)}$.

Again, let (L, d_L) be a dgl. Dual to the construction $C_*(L, d_L)$ we define the differential graded algebra, $C^*(L, d_L)$, by

$$C^*(L, d_L) = \text{Hom}(C_*(L, d_L), \mathbb{k})$$

as described in §3(d). Thus multiplication and the differential are given by

$$(f \cdot g)(c) = (f \otimes g)(\Delta c) \quad \text{and} \quad (df)(c) = -(-1)^{\deg f} f(dc), \quad \begin{array}{l} f, g \in C^*(L, d_L), \\ c \in C_*(L, d_L). \end{array}$$

(When the differential in L is clear from the context we may abuse notation and simply write $C^*(L)$ and $C_*(L)$, as in §22.)

This is entirely analogous to the construction in §5 of the singular cochain algebra on a space X as the dual of the singular chain coalgebra. However here we have the crucial fact that $C^*(L)$ is a *commutative* dga, because $C_*(L)$ is cocommutative.

Suppose now that (L, d_L) is a connected chain Lie algebra. Then $C_*(L) = \Lambda sL = \mathbb{k} \oplus \{C_i\}_{i \geq 2}$. It follows that $C^*(L)$ is a cochain algebra and so the machinery of Sullivan models (Part II) can be applied. We shall see now that if L is a connected chain Lie algebra and if each L_i is finite dimensional then $C^*(L)$ is, itself, a Sullivan algebra (§12).

Indeed, the decomposition $\Lambda sL = \bigoplus_k \Lambda^k sL$ defines a surjection $\Lambda sL \rightarrow sL$ (*not* compatible with the differential in ΛsL), which dualizes to an inclusion

$$(sL)^\sharp = \text{Hom}(sL, \mathbb{k}) \hookrightarrow C^*(L) .$$

Since $C^*(L)$ is commutative this extends uniquely to a morphism of graded algebras

$$\sigma : \Lambda(sL)^\sharp \rightarrow C^*(L) .$$

Lemma 23.1 *If (L, d) is a connected chain Lie algebra and each L_i is finite dimensional then*

$$\sigma : \Lambda(sL)^\sharp \xrightarrow{\cong} C^*(L)$$

is an isomorphism of graded algebras, which exhibits $C^(L)$ as a Sullivan algebra.*

proof: Let $y_i = sx_i$ be a basis for sL and let v_j be the dual basis for $(sL)^\sharp$: $\langle v_j, y_i \rangle = \delta_{ij}$. If $v \in (sL)^\sharp$ and $\Phi \in \Lambda^p(sL)^\sharp$ then

$$\langle v \wedge \Phi, y_{i_1} \wedge \cdots \wedge y_{i_{p+1}} \rangle = \langle v \otimes \Phi, \Delta(y_{i_1} \wedge \cdots \wedge y_{i_{p+1}}) \rangle , \quad \text{and}$$

$$C = \sum_{j=1}^{p+1} (-1)^{\deg y_{i_j} \deg \Phi} \langle v, y_{i_j} \rangle \langle \Phi, y_{i_1} \wedge \cdots \hat{y}_{i_j} \cdots \wedge y_{i_{p+1}} \rangle .$$

It follows that

$$\langle v_1^{k_1} \wedge \cdots \wedge v_n^{k_n}, y_n^{k_n} \wedge \cdots \wedge y_1^{k_1} \rangle = k_1! \cdots k_n!$$

(where $k_i \leq 1$ if $|v_i|$ is odd) and that $v_1^{k_1} \wedge \cdots \wedge v_n^{k_n}$ evaluates all other monomials to zero. Since $\text{char } \mathbb{k} = 0$ this implies that σ is an isomorphism, because $C_*(L)$ is finite dimensional in each degree.

Now σ identifies $C^*(L)$ as a cochain algebra of the form $(\Lambda V, d)$ with $V = \{V^p\}_{p \geq 2}$. Such a cochain algebra is always a Sullivan algebra. Indeed define $V(0) \subset V(1) \subset \cdots$ by $V(0) = V \cap \ker d$ and $V(k) = V \cap d^{-1}(\Lambda V(k-1))$. Since $(\Lambda V)^3 = V^3$, $d(V^2) \subset V^3$ and $V^2 \subset V(1) \subset \bigcup_k V(k)$. Suppose $V^{\leq n-1} \subset \bigcup_k V(k)$.

For $v \in V^n$, $dv = w + \Phi$ with $w \in V^{n+1}$ and $\Phi \in \Lambda V^{\leq n-1}$. Thus $dw = -d\Phi \in \Lambda \left(\bigcup_k V(k) \right)$ and so $w \in \bigcup_k V(k)$. But then also $v \in \bigcup_k V(k)$ and it follows that $V = \bigcup_k V(k)$. □

If V and W are graded vector spaces of finite type then an isomorphism $W \cong V^\sharp$ defines a pairing $\langle ; \rangle : W \times V \rightarrow \mathbb{k}$ which in turn determines an isomorphism $V \cong W^\sharp$. In the case we say V and W are *dual graded vector spaces with pairing* $\langle ; \rangle$.

Proposition 23.2 *Suppose (L, d_L) is a connected chain Lie algebra of finite type and each L_i is finite dimensional. Then*

- (i) $C^*(L, d_L) = (\Lambda V, d)$ and V and sL are dual graded vector spaces.
- (ii) $d = d_0 + d_1$ is the sum of its linear and quadratic parts (§12(a) and §13(e)), and

$$\langle d_0 v; sx \rangle = (-1)^{\deg v} \langle v; sd_L x \rangle \text{ and } \langle d_1 v; sx \wedge sy \rangle = (-1)^{\deg y + 1} \langle v; s[x, y] \rangle .$$

Conversely, suppose $(\Lambda V, d)$ is an arbitrary Sullivan algebra such that $d = d_0 + d_1$ and $V = \{V^p\}_{p \geq 2}$ with each V^p finite dimensional. Then a connected chain Lie algebra (L, d_L) is determined uniquely by the condition $(\Lambda V, d) = C^*(L, d_L)$.

proof: The first assertion follows from Lemma 23.1 and the definition of the differential in $C_*(L, d_L)$. For the second assertion let L be the desuspension of $\text{Hom}(V, \mathbb{k})$ and use the formulae above to define $d_L : L \rightarrow L$ and $[,] : L \times L \rightarrow L$. The equation $d^2 = 0$ reduces to $d_1^2 = 0$, $d_0 d_1 + d_1 d_0 = 0$ and $d_0^2 = 0$. These translate respectively to: $[,]$ is a Lie bracket (§21(e)), d_L is a Lie derivation and $d_L^2 = 0$. □

Finally suppose that (A, d) is a commutative cochain algebra in which $A = \mathbb{k} \oplus A^{\geq 2}$ and each A^i is finite dimensional. Let $(C, d_C) = \text{Hom}(A, \mathbb{k})$, recalling that d_C is the negative dual of d (§3(a)). Because A has finite type, the multiplication in A dualizes to a comultiplication in C , which makes (C, d_C) into a cocommutative differential graded coalgebra with dual cochain algebra (A, d) .

Apply the functor \mathcal{L} of §22 to this dgc and, abusing notation, denote the result by $\mathcal{L}_{(A,d)}$:

$$\mathcal{L}_{(A,d)} = \mathcal{L}(C, d_C) .$$

Note that $\mathcal{L}_{(A,d)}$ is a connected chain Lie algebra, finite dimensional in each degree. Thus the quasi-isomorphism φ of Theorem 22.9 dualizes to a quasi-isomorphism of commutative cochain algebras

$$C^*(\mathcal{L}_{(A,d)}) \xrightarrow{\cong} (A, d) ,$$

thereby exhibiting $C^*(\mathcal{L}_{(A,d)})$ as a functorial Sullivan model of (A, d) .

Example 1 *Graded Lie algebras.*

Suppose $L = \{L_i\}_{i \geq 1}$ is a graded Lie algebra and each L_i is finite dimensional. Then Proposition 23.2 reduces to

$$C^*(L, 0) = (\Lambda V, d_1)$$

in which sL and V are dual graded vector spaces and d_1 is purely quadratic. Conversely, any commutative cochain algebra of the form $(\Lambda V, d_1)$ with $V = \{V^p\}_{p \geq 2}$, each V^p finite dimensional and d_1 purely quadratic determines a graded Lie algebra L by the requirement that $(\Lambda V, d_1) = C^*(L, 0)$.

Next notice that Propositions 22.3 and 22.4 identify $C_*(L; UL)$ as an exact sequence

$$0 \leftarrow \mathbb{k} \xleftarrow{\varepsilon} UL \xleftarrow{d} sL \otimes UL \xleftarrow{d} \Lambda^2 sL \otimes UL \xleftarrow{d} \dots$$

of right UL -modules. In other words (cf. §20(a)) this is a free UL -resolution of the trivial UL -module, \mathbb{k} . On the other hand, it is immediate from the definitions that $C^*(L) = \text{Hom}_{UL}(C_*(L; UL), \mathbb{k})$, and so

$$H(C^*(L)) = \text{Ext}_{UL}(\mathbb{k}, \mathbb{k}) . \quad \square$$

Example 2 *Free graded Lie algebras.*

Suppose $E = \{E^i\}_{i \geq 2}$ is a graded vector space of finite type and $(H, 0)$ is the commutative cochain algebra with zero differential defined by

$$H = \mathbb{k} \oplus E \quad \text{and} \quad E \cdot E = 0 .$$

The dual graded coalgebra has the form $C = \mathbb{k} \oplus \bar{C}$ with $\bar{\Delta} = 0 : \bar{C} \rightarrow \bar{C} \otimes \bar{C}$. Thus the differential in $\mathcal{L}_{(C,0)}$ is zero (§22(e)). In other words, if W is the graded vector space defined by $W_i = \text{Hom}(E^{i+1}, \mathbb{k})$ then

$$\mathcal{L}_{(H,0)} = \mathcal{L}_{(C,0)} = (\mathbb{L}_W, 0) .$$

Thus in this case dualizing Theorem 22.9 provides a cochain algebra quasi-isomorphism

$$C^*(\mathbb{L}_W, 0) \xrightarrow{\cong} (H, 0) ,$$

and $C^*(\mathbb{L}_W, 0)$ is a minimal Sullivan algebra with purely quadratic differential. In other words, this is the minimal Sullivan model of $(H, 0)$, and so we recover the construction of Example 7, §12(d). \square

Example 3 *Minimal Lie models of minimal Sullivan algebras.*

Suppose $(\Lambda W, d)$ is a minimal Sullivan algebra and that $W = \{W^i\}_{i \geq 2}$ is a graded vector space of finite type. Let (\mathbb{L}_V, ∂) be a minimal Lie model of $\mathcal{L}_{(\Lambda W, d)}$ (Theorem 22.13). Then by Proposition 22.5 the quasi-isomorphism $\sigma : (\mathbb{L}_V, \partial) \xrightarrow{\cong} \mathcal{L}_{(\Lambda W, d)}$ induces a quasi-isomorphism $C_*(\sigma)$ which then dualizes to a quasi-isomorphism $C^*(\sigma) : C^*(\mathbb{L}_V, \partial) \xleftarrow{\cong} C^*(\mathcal{L}_{(\Lambda W, d)})$. On the other hand, as remarked above, we have a quasi-isomorphism $C^*(\mathcal{L}_{(\Lambda W, d)}) \xrightarrow{\cong} (\Lambda W, d)$.

This has a homotopy inverse $(\Lambda W, d) \xrightarrow{\cong} C^*(\mathcal{L}_{(\Lambda W, d)})$ (Proposition 12.9), and the composite

$$\varphi : (\Lambda W, d) \xrightarrow{\cong} C^*(\mathbb{L}_V, \partial)$$

exhibits $(\Lambda W, d)$ as a minimal model for $C^*(\mathbb{L}_V, \partial)$: *if (\mathbb{L}_V, ∂) is a minimal Lie model for $(\Lambda W, d)$ then $(\Lambda W, d)$ is a minimal Sullivan model for $C^*(\mathbb{L}_V, \partial)$.*

Recall further that $C^*(\mathbb{L}_V, \partial)$ is itself a Sullivan algebra $(\Lambda Z, d)$ with $Z = \text{Hom}(s\mathbb{L}_V, \mathbb{k})$. Thus dividing by $\Lambda^{\geq 2}W$ and $\Lambda^{\geq 2}Z$ yields a commutative diagram

$$\begin{array}{ccc} H^+(\Lambda W, d) & \xrightarrow{\cong} & H^+(C^*(\mathbb{L}_V, \partial)) \\ \downarrow \zeta & & \downarrow \zeta' \\ W & \xrightarrow[\cong]{H(Q(\varphi))} & \text{Hom}(sH(\mathbb{L}_V, \partial), \mathbb{k}) , \end{array}$$

where $Q(\varphi)$ is the linear part of φ and is a quasi-isomorphism because φ is (Proposition 14.13).

On the other hand, $\mathbb{L}_V = V \oplus [\mathbb{L}_V, \mathbb{L}_V]$ and $\text{Im } \partial \subset [\mathbb{L}_V, \mathbb{L}_V]$. Thus dividing by $[\mathbb{L}_V, \mathbb{L}_V]$ is a surjective chain map $\eta : (\mathbb{L}_V, \partial) \rightarrow (V, 0)$. The quasi-isomorphism

$C_{>0}(\mathbb{L}_V, \partial) \xrightarrow{\cong} sV$ of Proposition 22.8 converts the inclusion $s\mathbb{L}_V \rightarrow C_*(\mathbb{L}_V)$ into $s\eta$. Its dual therefore converts the dual of $s\eta$ into the surjection $\Lambda^+Z \rightarrow Z$. Thus it identifies $\text{Hom}(sH(\eta), \mathbb{k})$ with the map ζ' in the diagram above, and we obtain the commutative diagram

$$\begin{CD} H^+(\Lambda W, d) @>\cong>> \text{Hom}(sV, \mathbb{k}) \\ @V\zeta VV @VV\text{Hom}(sH(\eta), \mathbb{k})V \\ W @>\cong>> \text{Hom}(sH(\mathbb{L}_V), \mathbb{k}) \end{CD}$$

□

Example 4 *Sullivan algebras $(\Lambda W, d)$ for which $H^{2k}(\Lambda W, d) = 0, 1 \leq k \leq n$.*

Here we consider minimal Sullivan algebras $(\Lambda W, d)$ such that $W = \{W^i\}_{i \geq 2}$ is a graded vector space of finite type. The surjection $(\Lambda^+W, d) \rightarrow (W, 0)$ with kernel $\Lambda^{\geq 2}W$ induces a linear map $\zeta = \{\zeta^p : H^p(\Lambda W) \rightarrow W^p\}$. We shall use Lie models to show that

$$H^{2k}(\Lambda W, d) = 0, 1 \leq k \leq n \implies \zeta^p \text{ is injective, } p \leq 2n + 1.$$

In fact, let (\mathbb{L}_V, ∂) be a minimal Lie model for $\mathcal{L}_{(\Lambda W, d)}$ (Theorem 22.13). Then (Example 3), $H^+(\Lambda W, d) \cong \text{Hom}(sV, \mathbb{k})$ as graded vector spaces. Thus $V_{2k-1} = 0, 1 \leq k \leq n$ and $\mathbb{L}_{V \leq 2n}$ is concentrated in even degrees. For degree reasons the differential in $\mathbb{L}_{V \leq 2n}$ is then zero.

Recall from Example 3 that $\eta : (\mathbb{L}_V, \partial) \rightarrow (V, 0)$ is the surjection with kernel $[\mathbb{L}_V, \mathbb{L}_V]$. Since ∂ vanishes in degrees $\leq 2n$, $H_i(\eta)$ is surjective for $i \leq 2n$. It follows that $\text{Hom}(sH(\eta), \mathbb{k})$ is injective in degrees $p \leq 2n + 1$. Example 3 identifies this dual with ζ ; i.e. ζ^p is injective, $p \leq 2n + 1$. □

(b) The homotopy Lie algebra and the Milnor-Moore spectral sequence.

Consider an arbitrary minimal Sullivan algebra $(\Lambda W, D)$ such that $W = \{W^p\}_{p \geq 2}$ and each W^p is finite dimensional. Then $D = D_1 + D_2 + \dots$ with $D_i : W \rightarrow \Lambda^{i+1}W$. Associated with $(\Lambda W, D)$ is its homotopy Lie algebra E (as defined in §21(e)), and it is immediate from that definition that

$$(\Lambda W, D_1) = C^*(E)$$

(where E is regarded as a dgl with zero differential). Indeed, as observed in Proposition 23.2, this relation characterizes E .

Next suppose (L, d_L) is a connected chain Lie algebra with each L_i finite dimensional. Let

$$m : (\Lambda W, D) \xrightarrow{\cong} C^*(L, d_L)$$

be a minimal Sullivan model and let E be the homotopy Lie algebra of $(\Lambda W, D)$. As in Proposition 23.2, write $C^*(L, d_L) = (\Lambda V, d_0 + d_1)$ with V dual to sL . Let $Q(m) : W \rightarrow V$ be the linear part of m (§12(b)). Then $d_0 Q(m) = 0$.

Proposition 23.3 *With the hypotheses above, $Q(m)$ induces an isomorphism $W \xrightarrow{\cong} H(V, d_0)$. Its desuspended dual is an isomorphism of graded Lie algebras,*

$$H(L) \xrightarrow{\cong} E .$$

proof: Use Theorem 14.9 and Theorem 14.11 to extend m to an isomorphism of the form

$$(\Lambda W, D) \otimes (\Lambda(U \oplus \delta U), \delta) \xrightarrow{\cong} (\Lambda V, d_0 + d_1)$$

with $\delta : U \xrightarrow{\cong} \delta U$. It follows that $Q(m)$ induces an isomorphism

$$\Lambda H(Q(m)) : (\Lambda W, D_1) \xrightarrow{\cong} (\Lambda H(V, d_0), H(d_1)) .$$

Now V is dual to sL and d_0 is dual (up to sign and suspension) to d_L . This identifies $H(V, d_0)$ as the dual of $sH(L)$ and $(\Lambda H(V, d_0), H(d_1))$ as $C^*(H(L), 0)$. Since $(\Lambda W, D_1) = C^*(E, 0)$, the ‘desuspended’ dual of $H(Q(m))$ is an isomorphism from $H(L)$ to the homotopy Lie algebra E . □

Remark The effect of replacing $C^*(L)$ by $(\Lambda W, D)$ is to get rid of the linear part d_0 and to convert d_1 to $D_1 = H(d_1)$. However we ‘pay’ for this simplification through the addition of (possibly infinitely many) higher order terms D_2, D_3, \dots in the sum $D = \sum_i D_i$.

Finally, consider a general Sullivan algebra $(\Lambda V, d)$ in which $d = d_0 + d_1 + d_2 + \dots$, with $d_i : V \rightarrow \Lambda^{i+1}V$. Filter $(\Lambda V, d)$ by the decreasing sequence of ideals

$$F^p = \underbrace{(\Lambda V)^+ \dots (\Lambda V)^+}_{p \text{ factors}} , \quad p \geq 1 ,$$

and set $F^0 = \Lambda V$. Then (independently of the choice of generating space V) $F^p = \Lambda^{\geq p}V$, and so this is called the *wordlength filtration*. It determines a first quadrant spectral sequence (E_i, d_i) : the *Milnor-Moore spectral sequence* of the Sullivan algebra. Any morphism $\varphi : (\Lambda V, d) \rightarrow (\Lambda V', d')$ of Sullivan algebras is automatically filtration preserving and so induces a morphism $E_i(\varphi)$ of Milnor-Moore spectral sequences. It is immediate from the definition that

$$(E_0, d_0) = (\Lambda V, d_0) \quad \text{and} \quad E_0(\varphi) = \Lambda Q(\varphi)$$

where $Q(\varphi) : V \rightarrow V'$ is the linear part of φ (§12(b)).

Next, let

$$m : (\Lambda W, D) \xrightarrow{\cong} (\Lambda V, d)$$

be a minimal Sullivan model (Theorem 14.12) and suppose $W = \{W^p\}$ and has finite type. It follows from Theorem 14.9 and Theorem 14.11 that m extends to an isomorphism

$$(\Lambda W, D) \otimes (\Lambda(U \oplus \delta U), \delta) \xrightarrow{\cong} (\Lambda V, d)$$

with $\delta : U \xrightarrow{\cong} \delta U$. Since this isomorphism and its inverse preserve wordlength filtrations it induces an isomorphism of Milnor-Moore spectral sequences. In particular, if E is the homotopy Lie algebra for $(\Lambda W, D)$ then

$$\begin{aligned} (E_0, d_0) &\cong (\Lambda W, 0) \otimes (\Lambda(U \oplus \delta U), \delta) , \quad \text{and} \\ (E_1, d_1) &\cong (\Lambda W, D_1) = C^*(E) . \end{aligned}$$

Thus the Milnor-Moore spectral sequence converges from

$$E_2 = \text{Ext}_{UE}(\mathbb{k}, \mathbb{k}) \implies H(\Lambda W, D) .$$

Example 1 $C^*(L, d_L)$.

Let L be a connected chain Lie algebra with each L_i finite dimensional. Then the homotopy Lie algebra of $C^*(L, d_L)$ is just $H(L)$ (Proposition 23.3) and so the Milnor-Moore spectral sequence for $C^*(L, d_L)$ converges from

$$E_2 = \text{Ext}_{UH(L)}(\mathbb{k}, \mathbb{k}) \implies HC^*(L, d_L) . \quad \square$$

Example 2 *Topological spaces X .*

Suppose $(\Lambda W, D)$ is the minimal Sullivan model for a simply connected topological space X with rational homology of finite type. Then $H(\Lambda W, D) \cong H^*(X; \mathbb{k})$, $H_*(\Omega X; \mathbb{k}) \cong UL_X$ and L_X is isomorphic to the homotopy Lie algebra of $(\Lambda W, D)$. (This follows, respectively, from Corollary 10.10, Theorem 21.5 and Proposition 21.6.)

Thus *the Milnor-Moore spectral sequence for a minimal Sullivan model of X converges from*

$$E_2 = \text{Ext}_{H_*(\Omega X; \mathbb{k})}(\mathbb{k}, \mathbb{k}) \implies H^*(X; \mathbb{k}) .$$

□

(c) Cohomology with coefficients.

Suppose given a graded Lie algebra L and a right L -module M ; i.e., M is a right UL -module. We say this defines a *right representation* of L in M . Denote the action of $x \in L$ on $z \in M$ by $z \cdot x$. Since (cf. §3(d) and Propositions 22.4 and 22.6) $C_*(L; UL)$ is a $C_*(L)$ -comodule and a right UL -module and these structures are compatible,

$$C^*(L; M) = \text{Hom}_{UL}(C_*(L; UL), M)$$

is a $C^*(L)$ -module. Since $C_*(L; UL)$ is a UL -projective resolution of \mathbb{k} (Example 1, §23(a)) we may identify

$$H(C^*(L; M)) = \text{Ext}_{UL}(\mathbb{k}, M) . \tag{23.4}$$

The cohomology of this complex is called the *Lie algebra cohomology of L with coefficients in M* .

Now suppose that $L = \{L_i\}_{i \geq 1}$ and that each L_i is finite dimensional. Then each $C_k(L)$ is finite dimensional. Suppose further that $M = \{M^i\}_{i \geq p}$ some $p \in \mathbb{Z}$ and use the convention $M^i = M_{-i}$ to write $M = \{M_i\}_{i \leq -p}$. Thus if $\alpha : C_*(L) \rightarrow M$ is a linear map, it will vanish on $C_{> -|\alpha| - p}$. It follows that there are natural isomorphisms of graded vector spaces

$$\begin{aligned} C^*(L; M) &= \text{Hom}_{UL}(C_*(L) \otimes UL, M) \\ &= \text{Hom}(C_*(L), M) \\ &= \text{Hom}(C_*(L), \mathbb{k}) \otimes M \\ &= C^*(L) \otimes M. \end{aligned} \tag{23.5}$$

Write $C^*(L) = (\Lambda V, d)$, where V is dual to sL and

$$\langle dv; sx \wedge sy \rangle = (-1)^{\deg y + 1} \langle v; s[x, y] \rangle$$

(Example 1, §23(a)). Then (23.5) identifies $C^*(L; M)$ as the $(\Lambda V, d)$ -module given by

$$C^*(L; M) = (\Lambda V \otimes M, d)$$

with the $(\Lambda V, d)$ -module structure simply multiplication on the left. Thus the differential is determined by its restriction $d : M \rightarrow V \otimes M$. If we identify $V \otimes M = \text{Hom}(sL, M)$ via $\langle v \otimes z; sx \rangle = (-1)^{\deg z(\deg x + 1)} \langle v; sx \rangle z$ then this restriction is given by

$$\langle dz; sx \rangle = (-1)^{\deg z + \deg x} z \cdot x, \quad z \in M, x \in L, \tag{23.6}$$

as follows immediately from the definition of the differential in $C_*(L; -)$ at the end of §22(b).

Conversely suppose given a $(\Lambda V, d)$ -module of the form $(\Lambda V \otimes N, d)$ in which $d : N \rightarrow V \otimes N$. Then (23.6) defines a bilinear map $N \times L \rightarrow N$ and it follows easily from the equation $d^2 = 0$ that this is a right representation of L in N . By construction, if $N = \{N^i\}_{i \geq p}$ then

$$(\Lambda V \otimes N, d) = C^*(L; N).$$

Exercises

1. Let M be a L -module and assume that L and M are graded vector spaces of finite type. Prove that the graded dual $M^\#$ is also an L -module and that there exists a quasi-isomorphism $(C_*(L; M))^\# \rightarrow C^*(L; M^\#)$.
2. Let $L = L_1 \oplus L_2$ be the direct sum of two differential graded Lie algebras. Prove that $C^*(L) = C^*(L_1) \otimes C^*(L_2)$.

3. Let $(\mathbb{L}(V), d)$ be a free differential graded Lie algebra. Denote by $(\mathbb{L}(V'), d)$ and $(\mathbb{L}(V''), d)$ two copies of $(\mathbb{L}(V), d)$. Prove that there is a quasi-isomorphism $\varphi : (\mathbb{L}(V' \oplus V'' \oplus sV), D) \rightarrow (\mathbb{L}(V), d)$ with $\varphi(v') = \varphi(v'') = v$ for any $v \in V$, $D(sv) - v' + v'' \in \mathbb{L}^{\geq 2}(V' \oplus V'' \oplus sV)$, and $\varphi(sV) = 0$.

4. Two morphisms of differential graded Lie algebras $f, g : (\mathbb{L}(V), d) \rightarrow (L, d)$ are *homotopic*, $f \sim g$, if there is a morphism of differential graded Lie algebras $F : (\mathbb{L}(V' \oplus V'' \oplus sV), D) \rightarrow (L, d)$ satisfying $F(v') = f(v)$ and $F(v'') = g(v)$. Prove that the homotopy relation is an equivalence relation.

5. Prove that two morphisms of differential graded Lie algebras $f, g : (\mathbb{L}(V), d) \rightarrow (L, d)$ are homotopic in the sense of exercise 4 if and only if they are equivalent in the sense of §22, exercise 2.

6. Assume $f \sim g : (\mathbb{L}(V), d) \rightarrow (L, d)$. Prove that $C^*(f) \sim C^*(g)$.

7. Consider the diagram of differential graded Lie algebras

$$\begin{array}{ccc} & & (L_1, d_1) \\ & & \downarrow \varphi \\ (\mathbb{L}(V), d) & \xrightarrow{\psi} & (L_2, d_2) \end{array}$$

where $V = \{V_i\}_{i \geq 0}$ and $\dim V_i < \infty$. Prove that if φ is a quasi-isomorphism then there exists a morphism $\theta : (\mathbb{L}(V), d) \rightarrow (L_1, d_1)$ such that $\varphi\theta \sim \psi$.

8. Let $h : (\mathbb{L}(V), d) \rightarrow (\mathbb{L}(W), d)$, and $f, g : (\mathbb{L}(W), d) \rightarrow (L, d)$ be morphisms of differential graded Lie algebras. Assume that h is a quasi-isomorphism and that $fh \sim gh$. Prove that $f \sim g$.

9. Let $f, g : (\wedge V, d) \rightarrow (A, d_A)$ be morphisms of commutative differential graded algebras. Suppose that $f \sim g$. Prove that $\mathcal{L}(f) \sim \mathcal{L}(g)$.

10. Let L be a finite dimensional graded Lie algebra concentrated in even degrees. Prove that there exists an integer n such that $\dim H^n C^*(L, \mathbb{I}k) = 1$ and $\dim H^k C^*(L, \mathbb{I}k) = 0$, $k > n$.

24 Lie models for topological spaces and CW complexes

The ground ring in this section is a field \mathbb{k} of characteristic zero.

The fundamental bridge from topological to algebra used in this book is Sullivan's functor

$$\text{topological spaces} \xrightarrow{A_{PL}(-)} \text{commutative cochain algebras ,}$$

constructed in §10. Thus an algebraic object is a model for a topological space X if it is associated with the cochain algebra $A_{PL}(X)$.

For example (§12) a Sullivan model for X is, by definition, a Sullivan algebra $(\Lambda V_X, d)$ together with a quasi-isomorphism

$$m : (\Lambda V_X, d) \xrightarrow{\cong} A_{PL}(X) .$$

Analogously, we make the

Definition Let X be a simply connected topological space with rational homology of finite type. A *Lie model* for X is a connected chain Lie algebra (L, d_L) of finite type equipped with a dga quasi-isomorphism

$$m : C^*(L, d_L) \xrightarrow{\cong} A_{PL}(X) .$$

If $L = \mathbb{L}_V$ is a free graded Lie algebra we say (L, d_L) is a *free Lie model* for X .

If $n : C^*(E, d_E) \xrightarrow{\cong} A_{PL}(Y)$ is a Lie model for a second topological space Y then a *Lie representative* for a continuous map $f : X \rightarrow Y$ is a dgl morphism

$$\varphi : (L, d_L) \rightarrow (E, d_E)$$

such that $mC^*(\varphi) \sim A_{PL}(f)n$ (as defined at the start of §12).

Example 1 *The free Lie model of a sphere.*

In the tensor algebra $T(v)$ on a single generator, v , the free Lie subalgebra $\mathbb{L}(v)$ is given by

$$\mathbb{L}(v) = \begin{cases} \mathbb{k}v & \text{if } \deg v = 2n \\ \mathbb{k}v \oplus \mathbb{k}[v, v] & \text{if } \deg v = 2n + 1. \end{cases}$$

Thus the cochain algebra $C^*(\mathbb{L}(v))$ is given, respectively, by

$$C^*(\mathbb{L}(v)) = \begin{cases} (\Lambda(e), 0) & , \deg e = 2n + 1 \\ (\Lambda(e, e'), de' = e^2) & , \deg e = 2n + 2 . \end{cases}$$

The reader will recognize these as the minimal Sullivan models for spheres constructed in Example 1, §12(a). In other words, we have for all $n \geq 1$ a quasi-isomorphism

$$C^*(\mathbb{L}(v)) \xrightarrow{\cong} A_{PL}(S^{n+1}) , \deg v = n ,$$

which exhibits $(\mathbb{L}(v), 0)$ as a minimal free Lie model for S^{n+1} . □

As with Sullivan models we often abuse language and refer simply to (L, d_L) as a Lie model for X . Lie models provide a description of rational homotopy theory that is different from but equivalent to that provided by Sullivan models. In particular, if we restrict to simply connected topological spaces with rational homology of finite type then

- *Every space X has a minimal free Lie model, unique up to isomorphism, and every continuous map has a Lie representative.*
- *Every connected chain Lie algebra, (L, d_L) of finite type, and defined over \mathbb{Q} , is the Lie model of a simply connected CW complex, unique up to rational homotopy equivalence.*

If (L, d_L) is a Lie model for X then there is a natural isomorphism $H(L) \xrightarrow{\cong} \pi_*(\Omega X) \otimes_{\mathbb{Z}} \mathbb{k}$ of graded Lie algebras (§24(b)), which is in a certain sense ‘dual’ to the isomorphism $H(\Lambda V_X) \xrightarrow{\cong} H^*(X; \mathbb{k})$ in the context of Sullivan algebras. The first isomorphism suspends to an isomorphism

$$sH(L) \xrightarrow{\cong} \pi_*(X) \otimes \mathbb{k} ,$$

which (up to sign) converts the bracket in $H(L)$ to the Whitehead product in $\pi_*(X) \otimes \mathbb{k}$.

Finally, given any free rational chain Lie algebra (\mathbb{L}_V, d) (connected of finite type) we shall in (d) below, construct a CW complex X for which (\mathbb{L}_V, d) is a Lie model. Here

- For each $n \geq 2$, the n -cells D_α^n of X correspond to a basis $\{v_\alpha\}$ of V_{n-1} .
- The sub dgl $(\mathbb{L}_{V_{<n}}, d)$ is a Lie model for the n -skeleton X_n .
- The homology classes $[dv_\alpha] \in H(\mathbb{L}_{V_{<n-1}})$ correspond to the homotopy classes $[f_\alpha] \in \pi_{n-1}(X_{n-1}) \otimes \mathbb{k}$ of the attaching maps $f_\alpha : S_\alpha^{n-1} \rightarrow X_{n-1}$.

In this case (\mathbb{L}_V, d) will be called a *cellular Lie model for X* .

Throughout this section we shall use the properties of Sullivan algebras (§12, §14), often without explicit reference. For example, suppose (L, d_L) is a Lie model for a space X and (E, d_E) is a connected chain Lie algebra of finite type joined to (L, d_L) by a sequence of dgl quasi-isomorphisms. Then the Sullivan algebras $C^*(L, d_L)$ and $C^*(E, d_E)$ are joined by quasi-isomorphisms of commutative dga’s and hence suitable application of ‘lifting up to homotopy’ exhibits (E, d_E) as a Lie model for X .

Similarly, suppose (A, d_A) is a commutative model for X with $A^0 = \mathbb{k}$, $A^1 = 0$ and each A^i of finite dimension. Then the dga quasi-isomorphism $C^* \mathcal{L}_{(A, d_A)} \xrightarrow{\cong} (A, d_A)$ lifts to a dga quasi-isomorphism $C^* \mathcal{L}_{(A, d_A)} \xrightarrow{\cong} A_{PL}(X)$, which exhibits $\mathcal{L}_{(A, d_A)}$ as a Lie model for X .

This section is organized into the following topics

- (a) Free Lie models of topological spaces.
- (b) Homotopy and homology in a Lie model.
- (c) Suspensions and wedges of spheres.
- (d) Lie models for adjunction spaces.
- (e) CW complexes and chain Lie algebras.
- (f) Examples.
- (g) Lie model of a homotopy fibre.

(a) Free Lie models of topological spaces.

Let X and Y be simply connected topological spaces with rational homology of finite type. The next proposition establishes the first two bullets in the introduction to this section. Notice however that the ‘existence of a CW complex modelled by a chain Lie algebra’, but not the uniqueness is established directly in §24(d).

Proposition 24.1

- (i) *The space X has a minimal free Lie model (\mathbb{L}_V, d) , unique up to isomorphism, and any continuous map $f : X \rightarrow Y$ has a Lie representative.*
- (ii) *If $\mathbb{k} = \mathbb{Q}$, any connected chain Lie algebra (L, d_L) of finite type is the Lie model of a simply connected CW complex, unique up to rational homotopy equivalence.*

proof: (i) The construction in §12(a) provides minimal Sullivan models $m_X : (\Lambda V_X, d) \xrightarrow{\cong} A_{PL}(X)$ with $V_X = \{V_X^p\}_{p \geq 2}$ and each V_X^p finite dimensional, and $m_Y : (\Lambda V_Y, d) \xrightarrow{\cong} A_{PL}(Y)$ with the same properties. Apply the Quillen construction (§23(b)) to obtain natural quasi-isomorphisms

$$\tau_X : C^*(\mathcal{L}_{(\Lambda V_X, d)}) \xrightarrow{\cong} (\Lambda V_X, d) \quad \text{an} \quad \tau_Y : C^*(\mathcal{L}_{(\Lambda V_Y, d)}) \xrightarrow{\cong} (\Lambda V_Y, d) .$$

Composed with m_X , this exhibits $\mathcal{L}_{(\Lambda V_X, d)}$ and $\mathcal{L}_{(\Lambda V_Y, d)}$ as free Lie models of X and Y . Next, let $\psi : (\Lambda V_Y, d) \rightarrow (\Lambda V_X, d)$ be a Sullivan representative for f . Then $\psi\tau_Y = \tau_X C^*(\mathcal{L}_\psi)$, which exhibits \mathcal{L}_ψ as a Lie representative for f .

Finally, the argument in the proof of Theorem 22.13 now provides a surjective dgl quasi-isomorphism $\varrho : \mathcal{L}_{(\Lambda V_X, d)} \rightarrow (\mathbb{L}_V, d)$ onto a minimal free Lie chain algebra, which is connected of finite type because $\mathcal{L}_{(\Lambda V_X, d)}$ is. This exhibits (\mathbb{L}_V, d) as a minimal free model for X .

For uniqueness, suppose $m' : C^*(\mathbb{L}_W, d) \xrightarrow{\cong} A_{PL}(X)$ is an arbitrary minimal free Lie model. Lift the quasi-isomorphism $C^*(\mathbb{L}_V, d) \rightarrow A_{PL}(X)$ (up to homotopy) through m' to a quasi-isomorphism $C^*(\mathbb{L}_V, d) \rightarrow C^*(\mathbb{L}_W, d)$. This yields a chain of dgl quasi-isomorphisms

$$(\mathbb{L}_W, d) \leftarrow \mathcal{L}_{C^*(\mathbb{L}_W, d)} \rightarrow \mathcal{L}_{C^*(\mathbb{L}_V, d)} \rightarrow (\mathbb{L}_V, d) .$$

Use Proposition 22.11 to invert the first, and Proposition 22.14 to conclude that the resulting quasi-isomorphism $(\mathbb{L}_W, d) \rightarrow (\mathbb{L}_V, d)$ is an isomorphism. The same argument constructs a dgl morphism between minimal free Lie models that is a Lie representative for f .

(ii) Apply Theorem 17.10 to obtain

$$m_{C^*(L, d_L)} : C^*(L, d_L) \xrightarrow{\cong} A_{PL}(|C^*(L, d_L)|) ,$$

thereby exhibiting (L, d_L) as a Lie model for $|C^*(L, d_L)|$. If $C^*(L, d_L)$ is a Sullivan model for a second simply connected CW complex X then Theorem 17.12 identifies $|C^*(L, d_L)|$ as a rationalization of X . \square

(b) Homotopy and homology in a Lie model.

Fix a simply connected topological space X with rational homology of finite type, choose a Lie model (L, d_L) for X , and choose a minimal Sullivan model $(\Lambda V_X, d)$ for $C^*(L, d_L)$. We then have specified cochain algebra quasi-isomorphisms

$$(\Lambda V_X, d) \xrightarrow[m]{\cong} C^*(L, d_L) \xrightarrow[q]{\cong} A_{PL}(X)$$

whose composite is a minimal Sullivan model for X .

Now the homotopy Lie algebra L_X is just $\pi_*(\Omega X) \otimes \mathbb{k}$ with a certain Lie bracket, and in Theorem 21.6 we showed that it was naturally isomorphic to the homotopy Lie algebra of the minimal Sullivan model $(\Lambda V_X, d)$. Further, in Proposition 23.3 we used the quasi-isomorphism m to identify this homotopy Lie algebra with $H(L, d_L)$. Together these provide an *isomorphism of graded Lie algebras*,

$$\sigma_L : H(L, d_L) \xrightarrow{\cong} \pi_*(\Omega X) \otimes \mathbb{k} . \tag{24.2}$$

As in §21(e) we identify $\pi_*(X) \otimes \mathbb{k}$ as the suspension of $\pi_*(\Omega X) \otimes \mathbb{k}$ by writing $s\alpha = -(-1)^{\deg \alpha} \partial_*^{-1} \alpha$, $\alpha \in \pi_*(\Omega X) \otimes \mathbb{k}$, where ∂_* is the connecting homomorphism for the path space fibration. Then σ_L suspends to an isomorphism

$$\tau_L : sH(L) \xrightarrow{\cong} \pi_*(X) \otimes \mathbb{k} .$$

Now the Lie bracket in $\pi_*(\Omega X) \otimes \mathbb{k}$, as defined in §21(d), is given by

$$[\alpha, \beta] = (-1)^{\deg \alpha + 1} \partial_* [\partial_*^{-1} \alpha, \partial_*^{-1} \beta]_W , \quad \alpha, \beta \in \pi_*(\Omega X) ,$$

where $[,]_W$ denotes the Whitehead product. Since σ_L is an isomorphism of Lie algebras we deduce that

$$\tau_L s[\alpha, \beta] = (-1)^{\deg \alpha} [\tau_L s\alpha, \tau_L s\beta]_W , \quad \alpha, \beta \in H(L) .$$

Next we observe that a free Lie model (\mathbb{L}_V, d) for X also encodes the homology of X . Indeed the morphism $C^*(\mathbb{L}_V, d) \xrightarrow{\cong} A_{PL}(X)$ induces a cohomology isomorphism, which dualizes to an isomorphism $H(C_*(\mathbb{L}_V, d)) \xleftarrow{\cong} H_*(X; \mathbb{k})$. Let $\bar{d} : sV \rightarrow sV$ be the suspension of the linear part $d_V : V \rightarrow V$ of the differential d in \mathbb{L}_V . Then Proposition 22.8 provides a quasi-isomorphism $C_*(\mathbb{L}_V, d) \xrightarrow{\cong} (sV \oplus \mathbb{k}, \bar{d})$. Altogether then we obtain an isomorphism

$$sH(V, d_V) \oplus \mathbb{k} \cong H_*(X; \mathbb{k}) . \tag{24.3}$$

In particular, if (\mathbb{L}_V, d) is minimal then $H_*(X; \mathbb{k}) \cong sV \oplus \mathbb{k}$.

Finally, $[\mathbb{L}_V, \mathbb{L}_V]$ is the ideal in \mathbb{L}_V of elements of bracket length at least two. Thus $\mathbb{L}_V = V \oplus [\mathbb{L}_V, \mathbb{L}_V]$ and $[\mathbb{L}_V, \mathbb{L}_V]$ is preserved by d , so division by $[\mathbb{L}_V, \mathbb{L}_V]$ is a surjective linear map $\eta : (\mathbb{L}_V, d) \rightarrow (V, d_V)$. As in Example 3, §23(a), we have

Proposition 24.4 *With the hypotheses above the diagram*

$$\begin{array}{ccc} sH(\mathbb{L}_V, d) & \xrightarrow[\cong]{\tau_L} & \pi_*(X) \otimes \mathbb{k} \\ sH(\eta) \downarrow & & \downarrow \text{hur}_X \\ sH(V, d_V) & \xrightarrow[\cong]{} & H_+(X; \mathbb{k}) \end{array}$$

commutes, and identifies $sH(\eta)$ with the Hurewicz homomorphism hur_X .

proof: The quasi-isomorphism $C_*(\mathbb{L}_V) \rightarrow sV \oplus \mathbb{k}$ of Proposition 22.8 converts the inclusion $s(\mathbb{L}_V, d) \rightarrow C_*(\mathbb{L}_V)$ into $s\eta$. Thus we have to show that

$$\begin{array}{ccc} sH(\mathbb{L}_V, d) & \xrightarrow[\cong]{} & \pi_*(X) \otimes \mathbb{k} \\ \downarrow & & \downarrow \text{hur}_X \\ HC_*(\mathbb{L}_V) & \xrightarrow[\cong]{} & H_*(X; \mathbb{k}) \end{array}$$

commutes. But this is precisely the dual of the commutative diagram at the end of §13(c). \square

(c) Suspensions and wedges of spheres.

In this topic $\mathbb{k} = \mathbb{Q}$. We show that a suspension is, rationally, a wedge of spheres. More precisely, we establish the

Theorem 24.5 *The following conditions on a simply connected topological space X are equivalent*

- (i) *The rational Hurewicz homomorphism $\text{hur}_X : \pi_*(X) \otimes \mathbb{Q} \rightarrow H_+(X; \mathbb{Q})$ is surjective.*

- (ii) *There is a rational homotopy equivalence of the form $\bigvee_{\alpha \in I} S^{n_\alpha} \rightarrow X$ (each $n_\alpha \geq 2$).*
- (iii) *There is a well based, path connected space Y and a rational homotopy equivalence of the form $\Sigma Y \rightarrow X$.*
- (iv) *The rational homotopy Lie algebra L_X is a free graded Lie algebra.*

Before proving the theorem we consider the special case that $X = \bigvee_{\alpha \in I} S^{n_\alpha}$ with each $n_\alpha \geq 2$, and let $i_\alpha : S^{n_\alpha} \rightarrow X$ be the inclusion. The classes $[i_\alpha] \in \pi_{n_\alpha}(X)$ are mapped by hur_X to a basis of $H_+(X; \mathbb{Q})$. Hence they are linearly independent and are mapped by the connecting homomorphism to linearly independent elements w_α in $\pi_*(\Omega X) \otimes_{\mathbb{Z}} \mathbb{Q} = L_X$. Let W be the linear span of the w_α .

Proposition 24.6 *With the hypotheses and notation immediately above*

- (i) $\ker hur_X = s[L_X, L_X]$.
- (ii) *The inclusion of W extends to an isomorphism $\mathbb{L}_W \xrightarrow{\cong} L_X$.*

proof: (i) It is clearly sufficient to prove this for a finite wedge of spheres. But then $H_*(X; \mathbb{Q})$ has finite type and X is a suspension. Thus (Proposition 13.9) X has a commutative model of the form $k \oplus H$ with zero differential and $H \cdot H = 0$. Now $\mathcal{L}_{k \oplus H}$ is a Lie model for X and clearly has the form $(\mathbb{L}_V, 0)$. In particular, $L_X = H(\mathbb{L}_V) = \mathbb{L}_V$. Moreover, Proposition 24.4 identifies hur_X with the surjection $s\eta : s\mathbb{L}_V \rightarrow sV$, whose kernel is precisely $s[\mathbb{L}_V, \mathbb{L}_V]$.

(ii) It follows from (i) that $L_X = W \oplus [L_X, L_X]$. Since L_X is free Proposition 21.4 states precisely that $\mathbb{L}_W \xrightarrow{\cong} L_X$. □

proof of Theorem 24.5: If (i) holds then we can choose based continuous maps $f_\alpha : S^{n_\alpha} \rightarrow X$ so that the homology classes $H_*(f_\alpha)[S^{n_\alpha}]$ are a basis of $H_+(X; \mathbb{Q})$. Thus the map $f : \bigvee_{\alpha} S^{n_\alpha} \rightarrow X$ defined by the f_α induces an isomorphism of rational homology. Hence f is a rational homotopy equivalence (Theorem 8.6) and (i) \implies (ii).

Clearly (ii) \implies (iii). Suppose (iii) holds. Use the Cellular models theorem 1.4 to reduce to the case Y is a CW complex with a single 0-cell. Moreover, since $L_{\Sigma Y} \cong L_X$ we may take $X = \Sigma Y$.

Now for any finite subcomplex $Z \subset Y$ we know from Proposition 13.9 that ΣZ has a commutative model of the form $k \oplus H$ with zero differential and $H \cdot H = 0$. Hence $\mathcal{L}_{k \oplus H}$ is a Lie model for ΣZ and clearly this has the form $(\mathbb{L}_W, 0)$. Thus $L_Z \cong H(\mathbb{L}_W) = \mathbb{L}_W$.

Choose now a graded subspace $V \subset L_X$ so that $V \oplus [L_X, L_X] = L_X$ and extend the inclusion of V to a surjection $\sigma : \mathbb{L}_V \rightarrow L_X$ (Proposition 21.4). Let $\alpha \in \ker \sigma$. Then $\alpha \in \mathbb{L}_W$ for some finite dimensional subspace $W \subset V$. Moreover

by choosing a sufficiently large finite subcomplex $Z \subset Y$ we can arrange that $W \subset L_{\Sigma Z}$ and that the morphism $\mathbb{L}_W \rightarrow L_{\Sigma Z}$ sends α to zero. But clearly $W \cap [L_{\Sigma Z}, L_{\Sigma Z}] = 0$. Thus, since $L_{\Sigma Z}$ is free, Proposition 21.4 implies that $\mathbb{L}_W \rightarrow L_{\Sigma Z}$ is injective. Hence $\alpha = 0$, and σ is an isomorphism. It follows that L_X is free; i.e., (iii) \implies (iv).

It remains to show that (iv) \implies (i). We show (iv) \implies (ii), observing that (i) is a trivial consequence of (ii). If $L_X = \mathbb{L}_V$ choose based continuous maps $f_\alpha : S^{n_\alpha} \rightarrow X$ such that the homotopy classes $[f_\alpha] \in \pi_{n_\alpha}(X)$ are mapped by the connecting homomorphism ∂_* to a basis v_α of $V \subset L_X (= \pi_*(\Omega X) \otimes \mathbb{Q})$. The f_α define a continuous map $f : \bigvee_\alpha S^{n_\alpha} \rightarrow X$.

On the other hand, write $S = \bigvee_\alpha S^{n_\alpha}$ and let $i_\alpha : S^{n_\alpha} \rightarrow S$ be the inclusion. Then by Proposition 24.6, the elements $w_\alpha = \partial_*[i_\alpha]$ are the basis for a subspace $W \subset L_S$ such that $L_S = \mathbb{L}_W$. Since $\pi_*(\Omega f) : w_\alpha \mapsto v_\alpha$ it follows that $\pi_*(\Omega f) \otimes \mathbb{Q}$ is an isomorphism and f is a rational homotopy equivalence. \square

Example (Baues [19]) *If $H_+(X; \mathbb{Q})$ is concentrated in odd degrees then X has the rational homotopy type of a wedge of spheres.*

Here we consider simply connected spaces X with rational homotopy type of finite type. Let (\mathbb{L}_V, ∂) be a rational minimal Lie model for X (Proposition 24.1) then ∂ restricts to zero in V and so $sV \cong H_+(X; \mathbb{Q})$, by (24.3). Since $H_+(X; \mathbb{Q})$ is concentrated in odd degrees, $V = V_{\text{even}}$ and thus \mathbb{L}_V is concentrated in even degrees too. For degree reasons, then, the differential in \mathbb{L}_V is zero. Now the Lie algebra isomorphism (24.2) shows that $\pi_*(\Omega X) \otimes \mathbb{Q}$ is a free graded Lie algebra, and the conclusion follows from Theorem 24.5. \square

(d) Lie models for adjunction spaces.

Consider an adjunction space

$$Y = X \cup_f \left(\coprod_\alpha D^{n_\alpha+1} \right)$$

where:

- (i) X is simply connected with rational homology of finite type,
- (ii) $f = \{f_\alpha : (S^{n_\alpha}, *) \rightarrow (X, x_0)\}$ and
- (iii) the cells $D^{n_\alpha+1}$ are all of dimension ≥ 2 , with finitely many in any given dimension.

Suppose that

$$m : C^*(\mathbb{L}_V, d) \rightarrow A_{PL}(X)$$

is a free Lie model for X . We shall construct a free Lie model for Y . In fact, in §24(b) we constructed the isomorphism

$$\tau_L : sH(\mathbb{L}_V) \xrightarrow{\cong} \pi_*(X) \otimes \mathbb{k}$$

Thus the classes $[f_\alpha] \in \pi_{n_\alpha}(X)$ determine classes $s[z_\alpha] = \tau^{-1}[f_\alpha] \in sH(\mathbb{L}_V)$ represented by cycles $z_\alpha \in \mathbb{L}_V$. Let W be a graded vector space with basis $\{w_\alpha\}$ and $\deg w_\alpha = n_\alpha$. Then we can extend \mathbb{L}_V to a chain Lie algebra $\mathbb{L}_{V \oplus W} = \mathbb{L}(V \oplus W)$ by defining $dw_\alpha = z_\alpha$.

Theorem 24.7 *The chain Lie algebra $(\mathbb{L}_{V \oplus W}, d)$ is a Lie model for Y .*

proof: Decompose $C^*(\mathbb{L}_V, d)$ as the tensor product of a minimal Sullivan algebra $(\Lambda V_X, d)$ and a contractible Sullivan algebra. This exhibits $(\Lambda V_X, d)$ as a minimal Sullivan model for X . Let U be a graded vector space with basis $\{u_\alpha\}$ and $\deg u_\alpha = n_\alpha + 1$. Then it is shown in Proposition 13.12 that a commutative model $A = (\Lambda V_X \oplus U, d_A)$ for Y is given by setting:

- ΛV_X is a sub algebra.
- $U \cdot A^+ = 0$, and $d_A(U) = 0$.
- $d_A v = dv + \sum_\alpha \langle v; [f_\alpha] \rangle u_\alpha$, $v \in V_X$,

where we have already identified $\pi_*(X) \otimes \mathbb{k}$ with $\text{Hom}(V_X, \mathbb{k})$ as in Theorem 15.11. (In fact, the proof in 13.12 is for a single cell, so that there $U = \mathbb{k}u$, but the argument in the general case is identical.)

We proceed now in four steps.

Step (i): Description of \mathcal{L}_A .

Let (C, d_C) be the dgc dual to $(\Lambda V_X, d)$, so that $\mathcal{L}_{(\Lambda V_X, d)} = (\mathbb{L}(s^{-1}\bar{C}), \partial_C)$. Denote $\text{Hom}(U, \mathbb{k})$ by U^* , with dual basis u_α^* given by $\langle u_\beta, u_\alpha^* \rangle = \delta_{\beta\alpha}$. Then the graded coalgebra dual to A is just $C \oplus U^*$, and the elements of U^* are primitive: $\bar{\Delta}u_\alpha^* = 0$. The differential, δ , in $\text{Hom}(A, \mathbb{k})$ reduces to d_C in C and satisfies $\delta u_\alpha^* = (-1)^{\deg u_\alpha} c_\alpha$, where $c_\alpha \in C$ is the primitive cycle given by

$$\langle v, c_\alpha \rangle = \langle v; [f_\alpha] \rangle \quad \text{and} \quad \langle \Lambda^{\geq 2} V_X, c_\alpha \rangle = 0.$$

Thus $\mathcal{L}_A = (\mathbb{L}(s^{-1}\bar{C} \oplus s^{-1}U^*), \partial_A)$ with ∂_A restricting to ∂_C in $\mathbb{L}(s^{-1}\bar{C})$ and $\partial_A s^{-1}u_\alpha^* = (-1)^{\deg c_\alpha} s^{-1}c_\alpha$.

Step (ii): Identification of the z_α .

The cycles $c_\alpha \in C = \text{Hom}(\Lambda V_X, \mathbb{k})$ restrict to the linear functions $\bar{c}_\alpha \in \text{Hom}(V_X, \mathbb{k})$ which we have identified with $[f_\alpha] \in \pi_{n_\alpha}(X) \otimes \mathbb{k}$. On the other hand, the decomposition of $C^*(\mathbb{L}_V, d)$ as $(\Lambda V_X, d) \otimes E$, with E contractible, defines a surjective dga quasi-isomorphism

$$\varrho : C^*(\mathbb{L}_V, d) \xrightarrow{\cong} (\Lambda V_X, d)$$

which is left inverse to the inclusion. The linear part, ϱ_0 , of ϱ therefore dualizes to an inclusion,

$$\omega_0 : (\text{Hom}(V_X, \mathbb{k}), 0) \longrightarrow s(\mathbb{L}_V, d),$$

and $H(\omega_0)$ is inverse to the isomorphism τ . Thus $\tau^{-1}[f_\alpha] = H(\omega_0)(\bar{c}_\alpha) = [\omega_0\bar{c}_\alpha]$ and we may take

$$z_\alpha = s^{-1}\omega_0\bar{c}_\alpha .$$

Step (iii): The dgl quasi-isomorphism $\mathcal{L}_A \xrightarrow{\cong} (\mathbb{L}(V \oplus W), d)$.

The quasi-isomorphism ϱ of Step (ii) dualizes to a dgc quasi-isomorphism $\omega : (C, d_C) \rightarrow C_*(\mathbb{L}_V, d)$ and hence defines the dgl quasi-isomorphism

$$\xi : \mathcal{L}(C, d_C) \xrightarrow[\cong]{\mathcal{L}(\omega)} \mathcal{L}(C_*(\mathbb{L}_V)) \xrightarrow[\cong]{\psi} (\mathbb{L}_V, d) ,$$

where ψ is the quasi-isomorphism of Theorem 22.9. Moreover $\mathcal{L}(C, d_C) = \mathbb{L}(s^{-1}\bar{C})$ and $\xi(s^{-1}c_\alpha) = s^{-1}\omega_0\bar{c}_\alpha = z_\alpha$, as follows from the definition of ψ .

Extend ξ to a morphism of graded Lie algebras

$$\xi_A : \mathbb{L}(s^{-1}\bar{C} \oplus s^{-1}U^*) \rightarrow \mathbb{L}(V \oplus W)$$

by requiring $\xi s^{-1}u_\alpha^* = (-1)^{\deg c_\alpha} \omega_\alpha$. By Step (i), ξ_A is a dgl morphism from \mathcal{L}_A to $(\mathbb{L}(V \oplus W), d)$, as defined before the statement of the theorem. Since ξ is a quasi-isomorphism, so is its linear part: $s^{-1}\bar{C} \rightarrow V$, as we showed in Proposition 22.12. By construction, the linear part of ξ_A sends $s^{-1}U^*$ isomorphically to W . Hence the linear part of ξ_A is a quasi-isomorphism, and a second application of Proposition 22.12 establishes ξ_A as a dgl quasi-isomorphism, $\xi_A : \mathcal{L}_A \xrightarrow{\cong} (\mathbb{L}(V \oplus W), d)$.

Step (iv): $(\mathbb{L}(V \oplus W), d)$ is a Lie model for Y .

Since (A, d_A) is a commutative model for Y the quasi-isomorphism $C^*(\mathcal{L}_A) \xrightarrow{\cong} (A, d)$ identifies $C^*(\mathcal{L}_A)$ as a Sullivan model for Y and (\mathcal{L}_A, d) as a Lie model for Y . Since $(\mathcal{L}_A, d) \cong (\mathbb{L}(V \oplus W), d)$ the latter is a Lie model for Y as well. \square

Remark In the setup at the start of §24(d) let

$$j : X \rightarrow Y$$

denote the inclusion. It follows from the Remark after Proposition 13.12 that the surjection $(A, d_A) \rightarrow (\Lambda V_X, d)$ is connected by a chain of commutative dga quasi-isomorphisms to $A_{PL}(j)$. A tedious chase through the proof of Theorem 24.7 will therefore establish a homotopy commutative diagram

$$\begin{array}{ccc} C^*(\mathbb{L}_V) & \xleftarrow{C^*(\lambda)} & C^*(\mathbb{L}_{V \oplus W}) \\ \downarrow m & & \downarrow m' \\ A_{PL}(X) & \xleftarrow{A_{PL}(j)} & A_{PL}(Y) , \end{array}$$

where the left hand vertical arrow is the model with which we started and $\lambda : (\mathbb{L}_V, d) \rightarrow (\mathbb{L}_{V \oplus W}, d)$ is the inclusion.

(e) CW complexes and chain Lie algebras.

Suppose X is a connected CW complex with no 1-cells and finitely many cells in each dimension. Then we can use Theorem 24.7 to construct a Lie model (\mathbb{L}_V, d) for X such that: each $(\mathbb{L}_{V_{<n}}, d)$ is a Lie model for X_n , a basis $\{v_\alpha\}$ of V_n corresponds to the $(n+1)$ -cells D_α^{n+1} of X , and $s[dv_\alpha] \in sH(\mathbb{L}_{V_{<n}})$ corresponds to the class $[f_\alpha]$ of the attaching map $f_\alpha : S_\alpha^n \rightarrow X_n$ under the isomorphism $\tau_L : sH(\mathbb{L}_{V_{<n}}) \xrightarrow{\cong} \pi_*(\Omega X_n) \otimes \mathbb{Q}$ of §24(b).

We say that (\mathbb{L}_V, d) is a *cellular Lie model* for X .

Conversely, let (\mathbb{L}_V, d) be a connected free chain Lie algebra of finite type defined over \mathbb{Q} . Then we can use Theorem 24.7 to construct a CW complex X for which (\mathbb{L}_V, d) is a cellular Lie model.

Indeed, suppose the n -skeleton, X_n is constructed and $(\mathbb{L}_{V_{\leq n-1}}, d)$ is identified as a Lie model for X_n . Then the isomorphism τ_L identifies

$$sH_*(\mathbb{L}_{V_{\leq n-1}}, d) \xrightarrow{\cong} \pi_*(X_n) \otimes \mathbb{Q}.$$

Choose a basis $\{v_\alpha\}$ of V_n so the classes $s[dv_\alpha]$ correspond to elements in $\pi_n(X_n)$; i.e. are represented by continuous maps $f_\alpha : S^n \rightarrow X_n$, and set

$$X_{n+1} = X_n \cup_{\{f_\alpha\}} \left(\coprod_\alpha D^{n+1} \right).$$

Now Theorem 24.7 identifies $(\mathbb{L}_{V_{\leq n}}, d)$ as a Lie model for X_{n+1} .

This provides an inductive construction of X . By the Remark following Theorem 24.7 there is a homotopy commutative diagram of commutative dga's,

$$\begin{array}{ccccccc} \cdots & \longleftarrow & C^*(\mathbb{L}_{V_{<n}}, d) & \xleftarrow{C^*(\lambda)} & C^*(\mathbb{L}_{V_{\leq n}}, d) & \longleftarrow & \cdots \\ & & \simeq \downarrow & & \downarrow \simeq & & \\ \cdots & \longleftarrow & A_{PL}(X_n) & \longleftarrow & A_{PL}(X_{n+1}) & \longleftarrow & \cdots \end{array}$$

Since $C^*(\mathbb{L}_V, d) \rightarrow C^*(\mathbb{L}_{V_{\leq n}}, d)$ is an isomorphism in degrees $\leq n+1$, it is straightforward to construct a quasi-isomorphism $C^*(\mathbb{L}_V, d) \xrightarrow{\cong} A_{PL}(X)$. Thus (\mathbb{L}_V, d) is a cellular model for X .

(f) Examples.

Example 1 $(\mathbb{L}_V, 0)$ is the minimal Lie model of a wedge of spheres.

In fact Theorem 24.7 asserts that for any $V = \{V_i\}_{i \geq 1}$ of finite type with basis $\{v_\alpha\}$, $(\mathbb{L}_V, 0)$ is a Lie model of the space $X = \bigvee_\alpha S^{n_\alpha+1} = pt \cup_f \left(\coprod_\alpha D^{n_\alpha+1} \right)$, $\deg v_\alpha = n_\alpha$. Note that this also follows from §24(c). \square

Example 2 The free product of Lie models is a Lie model for a wedge, $\bigvee_\alpha X_\alpha$.

Suppose X_α are simply connected spaces and $X = \bigvee_\alpha X_\alpha$ has rational homology of finite type. Let $(\mathbb{L}_{V(\alpha)}, d_\alpha)$ be a Lie model for X_α .

Recall the free product defined in §21(c) and note that $\coprod_{\alpha} (\mathbb{L}_{V(\alpha)}, d_{\alpha})$ is the free dgl $(\mathbb{L}_{\bigoplus_{\alpha} V(\alpha)}, d)$, in which d restricts to d_{α} in each $V(\alpha)$. Simplify the notation $(\mathbb{L}_{V(\alpha)}, d_{\alpha})$ to (L_{α}, d_{α}) . Then $C^*(L_{\alpha}, d_{\alpha})$ is a Sullivan model for X_{α} . Now the Example of §12(c) exhibits the fibre product $\prod_{\alpha} \mathbb{k} (C^*(L_{\alpha}, d_{\alpha}))$ as a commutative model for X . On the other hand the inclusions $(L_{\alpha}, d_{\alpha}) \rightarrow \coprod_{\alpha} (L_{\alpha}, d_{\alpha})$ induce a dga morphism

$$C^* \left(\coprod_{\alpha} (L_{\alpha}, d_{\alpha}) \right) \rightarrow \prod_{\alpha} \mathbb{k} (C^*(L_{\alpha}, d_{\alpha})) .$$

We show that this is a quasi-isomorphism, *thereby exhibiting $\coprod_{\alpha} (L_{\alpha}, d_{\alpha})$ as a Lie model for $\bigvee_{\alpha} X_{\alpha}$.*

To see that this is a quasi-isomorphism note that it is the dual of the horizontal arrow in

$$\begin{array}{ccc}
 C_* \left(\coprod_{\alpha} (L_{\alpha}, d_{\alpha}) \right) & \longleftarrow & \mathbb{k} \oplus \bigoplus_{\alpha} C_+(L_{\alpha}, d_{\alpha}) \\
 \searrow \cong & & \swarrow \cong \\
 & & \mathbb{k} \oplus s \left(\bigoplus_{\alpha} V(\alpha) \right)
 \end{array}$$

in which the slant arrows are the quasi-isomorphisms of Proposition 22.8.

Finally, observe that the homology of a free product is the free product of the homologies, so that

$$\pi_* (\Omega \bigvee_{\alpha} X_{\alpha}) \otimes \mathbb{Q} = H \left(\coprod_{\alpha} \mathbb{L}_{V(\alpha)}, d_{\alpha} \right) = \coprod_{\alpha} \pi_* (\Omega X_{\alpha}) .$$

Example 3 *The direct sum of Lie models is a Lie model of the product.*

Again let (L_{α}, d_{α}) be Lie models for simply connected spaces X_{α} such that $X = \prod_{\alpha} X_{\alpha}$ has rational homology of finite type. Then only finitely many X_{α} will have rational homology degrees less than any given n and so we may suppose only finitely many L_{α} have elements in degrees $\leq n$. It follows that

$$C^* \left(\bigoplus_{\alpha} (L_{\alpha}, d_{\alpha}) \right) = \bigotimes_{\alpha} C^*(L_{\alpha}, d_{\alpha}) ;$$

which exhibits $\bigoplus_{\alpha} (L_{\alpha}, d_{\alpha})$ as a Lie model for X (Example 2, §12(a)). □

Example 4 *A Lie model for $S_a^3 \vee S_b^3 \cup_{[\alpha, [\alpha, \beta]_W]_W} D^8$.*

Let $\alpha, \beta \in \pi_3(S_a^3 \vee S_b^3)$ be the elements represented by S_a^3 and S_b^3 respectively. Then (cf. Example 1) a Lie model for $S_a^3 \vee S_b^3$ is just $(\mathbb{L}(v, w), 0)$ with $\deg v = \deg w = 2$ and v, w corresponding to α, β . Moreover, the isomorphism $\pi_*(S_a^3 \vee S_b^3) \otimes \mathbb{Q} \cong s\mathbb{L}(v, w)$ identifies $[\alpha, [\alpha, \beta]_W]_W$ with $s[v, [v, w]]$, as is shown in §24(b). Hence by Theorem 24.7,

$$(\mathbb{L}(v, w, u), du = [v[v, w]]) \text{ is a Lie model for } S_a^3 \vee S_b^3 \cup_{[\alpha, [\alpha, \beta]_W]_W} D^8.$$

□

Example 5 *Lie models for $\mathbb{C}P^{\infty}$ and $\mathbb{C}P^n$.*

The space $\mathbb{C}P^{\infty}$ is a $K(\mathbb{Z}, 2)$ and so its minimal Sullivan model is $A = (\Lambda(a), 0)$ with $\deg a = 2$ — cf. §15(b), Example 2. Thus \mathcal{L}_A is a Lie model for $\mathbb{C}P^{\infty}$. This Lie model has the form $\mathbb{L}(v_1, v_2, v_3, \dots)$ with v_i the desuspended dual of a^i . (Thus $\deg v_i = 2i - 1$). In the coalgebra C dual to A let c_i be the element dual to a^i . Then $\bar{\Delta}c_k = \sum_{i+j=k} c_i \otimes c_j$. Thus the formula in §22(e) shows that the differential in \mathcal{L}_A is given by

$$dv_k = \frac{1}{2} \sum_{i+j=k} [v_i, v_j].$$

Since $H(\mathcal{L}_A, d) \cong \pi_*(\mathbb{C}P^{\infty}) \otimes \mathbb{Q}$ it follows that

$$H_n(\mathcal{L}_A, d) = \begin{cases} \mathbb{Q} & , n = 2 \\ 0 & , \text{otherwise,} \end{cases}$$

a fact that may not be immediately obvious from the formula for d .

Notice that the construction of a CW-complex for this Lie model (§24(e)) has one cell in each even degree $2n$ and no cells of odd degree. The $2n$ -skeleton has the rational homotopy type of $\mathbb{C}P^n$, with Lie model $\mathcal{L}(v_1, \dots, v_n)$ and the same differential.

In this model $\sum_{i+j=n+1} [v_i, v_j]$ is a cycle whose suspended homology class in $\pi_{2n+1}(\mathbb{C}P^n) \otimes \mathbb{Q}$ is not a Whitehead product. □

Example 6 *A Lie model for $(\mathbb{C}P^2 \vee S^3) \cup_{[\alpha, \beta]_W} D^8$.*

As we saw in Example 5, a Lie model for $\mathbb{C}P^2$ is just $(\mathbb{L}(v_1, v_2), d)$ with $dv_2 = \frac{1}{2}[v_1, v_1]$. Thus $[v_1, v_2]$ is a cycle and the homology class of $s[v_1, v_2]$ corresponds to a class $\alpha \in \pi_5(\mathbb{C}P^2) \otimes \mathbb{Q}$. Let $\beta \in \pi_3(S^3)$ be the fundamental class. Then as in Example 4, Theorem 24.7 shows that

$$\left(\mathbb{L}(v_1, v_2, w, u); dv_2 = \frac{1}{2}[v_1, v_2], dw = 0, du = [[v_1, v_2], w] \right)$$

is a Lie model for $(\mathbb{C}P^2 \vee S^3) \cup_{[\alpha, \beta]_w} D^8$. \square

Example 7 *Coformal spaces.*

A simply connected topological space X with rational homology of finite type is called *coformal* (sometimes π -formal in the literature) if it has a Lie model $(L, 0)$ with zero differential. In this case L is the homotopy Lie algebra L_X (§21(d), (e)); i.e., *the rational homotopy type of X can be formally deduced from its homotopy Lie algebra.* (Note the parallel with formal spaces as defined in §12(c).)

If X is coformal with Lie model $(L, 0)$ then $C^*(L, 0)$ is a Sullivan model for X of the form $(\Lambda V_X, d_1)$ with $d_1 : V_X \rightarrow \Lambda^2 V_X$. Conversely any Sullivan model of this form can be written as $C^*(L, 0)$ — cf. §23(a): *X is coformal if and only if it has a ‘purely quadratic’ minimal Sullivan model.*

Finally, recall from Example 1 in §23(a) that $H(C^*(L, 0)) = \text{Ext}_{UL}(\mathbb{k}, \mathbb{k})$. But $UL_X \cong H_*(\Omega X; \mathbb{k})$, as we saw in Theorem 21.5. Thus

$$X \text{ coformal} \implies H^*(X; \mathbb{k}) = \text{Ext}_{H_*(\Omega X; \mathbb{k})}(\mathbb{k}, \mathbb{k}). \quad \square$$

Example 8 *Minimal free chain Lie algebras.*

Suppose (\mathbb{L}_V, d) is a minimal connected free chain Lie algebra of finite type, defined over \mathbb{Q} and let X be a CW complex for which (\mathbb{L}_V, d) is a cellular Lie model (§24(e)). Then

- $sV \oplus \mathbb{Q} \cong H_*(X; \mathbb{Q})$, by the last comment in §24(b).
- A basis of V is in 1-1 correspondence with the cells of positive dimension of X , which also form a basis of the reduced cellular chain complex of X .

The conclusion is that the differential in the rational cellular chain complex of X must be zero, and hence the differential in the integral cellular chain complex is zero too. In other words:

$H_*(X; \mathbb{Z})$ is a free \mathbb{Z} -module with basis corresponding to a basis of $\mathbb{Q} \oplus sV$. \square

(g) Lie model for a homotopy fibre.

Let

$$0 \rightarrow (I, d_I) \rightarrow (L, d_L) \xrightarrow{p} (K, d_K) \rightarrow 0$$

be a short exact sequence of differential graded Lie algebras (connected and of finite type). By taking cochain algebras (see Section 23(a)), we obtain a relative Sullivan algebra (see Section 14)

$$C^*(K, d_K) \xrightarrow{C^*(p)} C^*(L, d_L) \rightarrow C^*(I, d_I) .$$

Proposition 24.8 *When p is a Lie representative for a continuous map $f : X \rightarrow Y$ between simply connected spaces, then (I, d_I) is a Lie model for the homotopy fibre of f .*

proof: By hypothesis there is a homotopy commutative diagram

$$\begin{array}{ccc}
 C^*(K, d_K) & \xrightarrow{m_Y} & A_{PL}(Y) \\
 C^*(p) \downarrow & & \downarrow A_{PL}(f) \\
 C^*(L, d_L) & \xrightarrow{m_X} & A_{PL}(X) .
 \end{array} \tag{24.9}$$

Now let H be the homotopy from $m_X C^*(p)$ to $A_{PL}(f)m_Y$. Then in the commutative diagram

$$\begin{array}{ccc}
 C^*(K, d_K) & \xrightarrow{H} & A_{PL}(X) \otimes \Lambda(t, dt) \\
 C^*(p) \downarrow & & \simeq \downarrow id \otimes \varepsilon_0 \\
 C^*(L, d_L) & \xrightarrow{m_X} & A_{PL}(X)
 \end{array}$$

we may lift m_X through $id \otimes \varepsilon_0$ because $C^*(p)$ is the inclusion of a relative Sullivan algebra (Proposition 14.4). This provides a homotopy $m_X \sim m'_X$ such that $m'_X C^*(p) = A_{PL}(f)m_Y$. In other words we may suppose that (24.9) commutes exactly.

Now Proposition 15.5 identifies $C^*(I, d_I)$ as a Sullivan model for the homotopy fibre, F , of f , and hence by definition identifies (I, d_I) as a Lie model for F . \square

Exercises

1. Determine the minimal Lie models of the spaces:

$$\mathbb{C}P^n \# \mathbb{C}P^n, \quad S^3 \times S^3 \times S^3, \quad \mathbb{C}P^4/S^2, \quad \mathbb{C}P^5/S^2.$$

2. Show that if X is a simply connected CW complex and $H_*(\Omega X; \mathbb{Q})$ is a tensor algebra, then X has the rational homotopy type of a wedge of spheres.

3. Let $(\wedge V, d) \rightarrow (A, 0)$ be a Sullivan minimal model with $V^1 = 0$, and let x be of even degree and $\varphi : (A \otimes \wedge x, 0) \rightarrow B = (A \otimes \wedge x / I, 0)$ a projection whose kernel is the ideal $I \subset A \otimes \wedge^+ x$.

a) Prove that there is a quasi-isomorphism $(A \oplus Z, 0) \rightarrow (B \otimes_{E(x)} \wedge \bar{x}, D)$ where $Z = (\ker d \cap B) \otimes \wedge \bar{x}$.

b) Suppose that the continuous map $f : X \rightarrow Y$ admits φ as commutative model, and let F be the homotopy fibre of f . Prove that F admits a model of the form $(A \oplus Z) \otimes_{(\wedge V, d)} E(V)$ and thus that F has the rational homotopy type of a wedge of spheres.

c) Prove that there exists a short exact sequence of graded Lie algebras

$$0 \rightarrow \mathbb{L}(V) \rightarrow \pi_*(\Omega X) \otimes \mathbb{Q} \xrightarrow{\pi_* (\Omega f)} \pi_*(\Omega Y) \otimes \mathbb{Q} \rightarrow 0.$$

4. Let $H = \Lambda(x_1, \dots, x_n)/I$, where the x_i 's have even degree and where the ideal I is generated by monomials. Prove that $H \cong ((\dots (\Lambda x_1)/I_1 \otimes \Lambda x_2)/I_2 \otimes \dots \otimes \Lambda x_n)/I_n$, where each I_p is an ideal in $\Lambda(x_1, x_2, \dots, x_p)$ contained in the ideal generated by x_p . Let X be a formal space such that $H^*(X; \mathbb{Q}) = H$. Deduce from exercise 3 that there is a finite sequence of extensions

$$\begin{aligned} 0 \rightarrow \mathbb{L}(V_1) \rightarrow L_1 \rightarrow (x_1, \dots, x_n) \rightarrow 0 \\ 0 \rightarrow \mathbb{L}(V_2) \rightarrow L_2 \rightarrow L_1 \rightarrow 0 \\ \dots \\ 0 \rightarrow \mathbb{L}(V_n) \rightarrow \pi_*(\Omega X) \otimes \mathbb{Q} \rightarrow L_{n-1} \rightarrow 0, \end{aligned}$$

where (x_1, \dots, x_n) denotes the abelian Lie algebra on the variables x_1, x_2, \dots, x_n .

5. Let X and Y be simply connected CW complexes of finite type. Prove that $L_{X \vee Y} = L_X \amalg L_Y$. Suppose that $x \in (L_X)_{\text{even}}$ and $y \in (L_Y)_{\text{even}}$. Prove that $\mathbb{L}(x, y) \subset L_{X \vee Y}$.

25 Chain Lie algebras and topological groups

In this section the ground ring is \mathbb{Q} .

In this section we pass from algebra to CW complexes using the spatial realization functor $| \cdot |$ of §17(c). It will often be convenient to abbreviate the notation $|A, d|$ simply to $|A|$. We shall also abbreviate $|C^*(L, d_L)|$ simply to $|C^*L|$.

Let (L, d_L) be an arbitrary connected chain Lie algebra of finite type. Our principal objective is to

- Convert the universal enveloping algebra (UL, d_L) to a topological group $|\Gamma L|$.
- Construct a contractible CW complex $|C^*(L; \Gamma L)|$ and a principal fibre bundle

$$|C^*(L; \Gamma L)| \xrightarrow{p_L} |C^*L|, \quad |C^*(L; \Gamma L)| \times |\Gamma L| \longrightarrow |C^*(L; \Gamma L)|,$$

thereby identifying $|C^*L|$ as a classifying space for $|\Gamma L|$.

In particular, if (L, d_L) is a Lie model for a simply connected topological space X then we will deduce a chain of rational equivalences of topological monoids from ΩX to $|\Gamma L|$.

This section is divided into the following topics

- (a) The topological group $|\Gamma L|$.
- (b) The principal fibre bundle $|C^*(L; \Gamma L)| \xrightarrow{p_L} |C^*L|$.
- (c) $|\Gamma L|$ as a model for the topological monoid, ΩX .
- (d) Morphisms of chain Lie algebras and the holonomy action.

Throughout we shall work with the spatial realization functor (§17(c)) from commutative cochain algebras to CW complexes. We recall that it converts the tensor product of cochain algebras to the topological product of spaces (Example of §17(c)).

(a) The topological group, $|\Gamma L|$.

Recall that the universal enveloping algebra, (UL, d) is a dg Hopf algebra (§21) which is cocommutative as a coalgebra. Thus its dual $(\Gamma L, \delta_L) = \text{Hom}(UL, \mathbb{Q})$ is also a dg Hopf algebra with commutative multiplication μ_Γ and comultiplication Δ_Γ dual, respectively, to the comultiplication and multiplication in UL . Since ΓL is commutative, both μ_Γ and Δ_Γ are dga morphisms.

Proposition 25.1 *The CW complex $|\Gamma L|$ is a topological group, with multiplication $|\Delta_\Gamma|$ and topological diagonal $|\mu_\Gamma|$.*

proof: The coassociativity of Δ_Γ implies that

$$|\Delta_\Gamma| : |\Gamma L| \times |\Gamma L| \longrightarrow |\Gamma L|$$

is an associative product. The single 0-cell of $|\Gamma L|$ is the augmentation $e : \Gamma L \rightarrow \mathbb{k}$, and its compatibility with Δ_Γ implies that $e \in |\Gamma L|$ is a two-sided identity.

To construct an inverse we first construct a distinguished involution ν in UL . Let UL^{opp} be the dg Hopf algebra defined as follows: as a differential graded coalgebra, $UL^{opp} = UL$. However the product in UL^{opp} is given by $a \cdot b = (-1)^{\deg a \deg b} ba$, where ba is the product in UL . Define $\alpha : L \rightarrow UL^{opp}$ by $\alpha x = -x$. Then $\alpha[x, y] = \alpha x \cdot \alpha y - (-1)^{\deg x \deg y} \alpha y \cdot \alpha x$, and so α extends to a dga morphism $\nu : UL \rightarrow UL^{opp}$.

We may regard ν as a self morphism of the dgc, UL . Clearly $\nu^2 = id$, and so ν is an automorphism satisfying $\nu(ab) = (-1)^{\deg a \deg b} ba$.

Observe next that the composite

$$\varphi : UL \xrightarrow{\Delta} UL \otimes UL \xrightarrow{id \otimes \nu} UL \otimes UL \xrightarrow{mult} UL$$

coincides with $UL \xrightarrow{aug} \mathbb{k} \xrightarrow{incl} UL$. In fact, if $x \in L$ then $\varphi x = mult(x \otimes 1 - 1 \otimes x) = 0$. Moreover if $\Delta a = \sum a_i \otimes a'_i$ and $\Delta b = \sum b_j \otimes b'_j$ then

$$\varphi(ab) = \sum_{i,j} \pm a_i b_j (\nu b'_j) \nu a'_i = \sum_i \pm a_i (\varphi b) \nu a'_i .$$

Hence if $\varphi b = 0$ then $\varphi(ab) = 0$ and so $\varphi = 0$ in UL_+ .

Let $\nu^* = Hom(\nu, \mathbb{k})$ be the dual of ν . It is an automorphism of the cochain algebra $(\Gamma L, \delta_L)$. Apply $|\cdot|$ to the dual of the formula above for φ to see that $|\nu^*|$ is an inverse in $|\Gamma L|$, which is therefore a topological group.

Finally, note that in any commutative cochain algebra (A, d) the multiplication μ_A realizes to the topological diagonal in $|A, d|$, as follows immediately from the definitions. □

(b) The principal fibre bundle, $|C^*(L; \Gamma L)| \xrightarrow{p_L} |C^*L|$.

Recall the acyclic construction $C_*(L; UL)$ considered in §22(c). It is, in particular, a cocommutative differential graded coalgebra of the form $(\Lambda sL \otimes UL, d)$. Moreover, as we remarked in §22(c), the projection $\rho : (\Lambda sL \otimes UL, d) \rightarrow (\Lambda sL, d)$ and the right module action $\alpha : (\Lambda sL \otimes UL, d) \otimes (UL, d) \rightarrow (\Lambda sL \otimes UL, d)$ are both dgc morphisms.

Apply the realization functor to the cochain algebra $C^*(L; \Gamma L)$ dual to $(\Lambda sL \otimes UL, d)$, to construct the CW complex $|C^*(L; \Gamma L)|$. (Note that the differential in $C^*(L; \Gamma L) = (C^*(L) \otimes \Gamma L, d)$ is *not* the tensor product differential, and so $|C^*(L; \Gamma L)|$ is *not* the product of $|C^*L|$ and $|\Gamma L|!$). The duals ρ^* and α^* of the morphisms above realize to continuous maps

$$|C^*(L; \Gamma L)| \xrightarrow{p_L} |C^*L| \quad \text{and} \quad |C^*(L; \Gamma L)| \times |\Gamma L| \longrightarrow |C^*(L; \Gamma L)| .$$

Proposition 25.2 *The construction above is a principal $|\Gamma L|$ -fibre bundle whose total space, $|C^*(L; \Gamma L)|$, is a contractible CW complex.*

proof:

Step 1: $C^(L)$ is a Sullivan algebra and the inclusion of $C^*(L)$ in $C^*(L; \Gamma L)$ is a relative Sullivan algebra.*

The first assertion is Lemma 23.1. For the second recall the isomorphism $\gamma : \Lambda L \xrightarrow{\cong} UL$ of Proposition 21.2. It is obvious that γ preserves differentials and the comultiplication. Thus, dually, $(\Gamma L, \delta_L) = (\Lambda L^*, -d_L^*)$ as graded algebras, L^* denoting $\text{Hom}(L, \mathbb{Q})$ and d_L^* the dual of d_L . It now follows exactly as in Proposition 23.1 that $C^*(L; \Gamma L) = (C^*(L) \otimes \Lambda L^*, d)$ is a relative Sullivan algebra with respect to the inclusion of $C^*(L)$.

Step 2: $|C^(L; \Gamma L)|$ is a contractible CW complex.*

By Step 1, $C^*(L; \Gamma L)$ is itself a Sullivan algebra of the form $(\Lambda V, d)$ with $V = (sL \otimes 1)^* \oplus (1 \otimes L)^*$. The linear part of the differential, $d_0 : V \rightarrow V$, is dual to the restriction of the differential in $C_*(L; UL)$ to $sL \otimes 1 \oplus 1 \otimes L$. Since $d(sx \otimes 1) = -sd_L x \otimes 1 + (-1)^{\text{deg } x+1} 1 \otimes x$ and $d(1 \otimes x) = 1 \otimes d_L x$ it follows that $(sL \otimes 1) \oplus (1 \otimes L) = (sL \otimes 1) \oplus d(sL \otimes 1)$. Dually, $V = U \oplus d_0 U$ with $d_0 : U \xrightarrow{\cong} d_0 U$. From §14(b) we deduce that $C^*(L; \Gamma L) = \Lambda(U \oplus dU)$ with $d : U \xrightarrow{\cong} dU$.

Now let $\{u_\alpha\}$ be a basis of U . A dga morphism $\varphi : \Lambda(U \oplus dU) \rightarrow (A_{PL})_n$ is specified by the arbitrary choice of elements $\varphi u_\alpha \in (A_{PL})_n^{\text{deg } u_\alpha}$. This identifies $\langle \Lambda(U \oplus dU) \rangle$ as the extendable simplicial set $\prod_\alpha A_{PL}^{|u_\alpha|}$. Thus $|C^*(L; \Gamma L)| = |\Lambda(U \oplus dU)|$ is a contractible CW complex (Example 3, §17(a)).

Step 3: $p_L : |C^(L; \Gamma L)| \rightarrow |C^*L|$ is a principal $|\Gamma L|$ -fibre bundle.*

Recall that $C^*(L; \Gamma L) = (C^*(L) \otimes \Gamma L, d)$. An n -simplex of $|C^*L|$ is a dga morphism $\sigma : C^*(L) \rightarrow (A_{PL})_n$. As in the proof of Proposition 17.9, the pullback of p_L over σ has the form

$$\Delta^n \times_{|(A_{PL})_n|} |(A_{PL})_n \otimes_{C^*(L)} (C^*(L) \otimes \Gamma L, d)|.$$

If we can exhibit this as $\Delta^n \times |\Gamma L|$, compatibly with the projection on Δ^n and the action of $|\Gamma L|$, then Proposition 2.8 will apply and show that p_L is a principal bundle.

Denote $(A_{PL})_n$ by A and $(A_{PL})_n \otimes_{C^*(L)} (C^*(L) \otimes \Gamma L, d)$ by $(A \otimes \Gamma L, d)$. Note that the dual, α^* , of the UL -action α induces an obvious morphism $\beta : (A \otimes \Gamma L, d) \rightarrow (A \otimes \Gamma L, d) \otimes (\Gamma L, \delta_L)$. Since $H(A) = \mathbb{Q}$, the argument of Lemma 14.8 with $\mathbb{Q} \rightarrow A$ replacing $B_1 \rightarrow B$ shows that id_A extends to an isomorphism $\psi : (A \otimes \Gamma L, d) \xrightarrow{\cong} (A, d) \otimes (\Gamma L, \delta_L)$. Combine this with the augmentation, e , of $(\Gamma L, \delta_L)$ to define $(id \otimes e)\psi : (A \otimes \Gamma L, d) \rightarrow (A, d)$. The composite

$$\varphi : (A \otimes \Gamma L, d) \xrightarrow{\beta} (A \otimes \Gamma L, d) \otimes (\Gamma L, \delta_L) \xrightarrow{(id \otimes e)\psi \otimes id} (A, d) \otimes (\Gamma L, \delta_L)$$

reduces to the identity in A and satisfies $\varphi(1 \otimes z) - 1 \otimes z \in A^+ \otimes \Gamma L, z \in \Gamma L$. Hence φ is an isomorphism. It clearly converts β into $id \otimes \Delta_\Gamma$. Thus $|\varphi| : |A| \times |\Gamma L| \xrightarrow{\cong} |A \otimes \Gamma L, d|$ compatibly with the projection on $|A|$ and the action of $|\Gamma L|$. \square

Notice that Proposition 25.2 identifies $|C^*L|$ as weakly homotopy equivalent to the classifying space (§2(e)), $B_{|\Gamma L|}$. In fact (cf. §2(e)) the principal bundle $p : |C^*(L; \Gamma L)| \rightarrow |C^*L|$ pulls back from the universal bundle $E_{|\Gamma L|}$ via a map $f : |C^*L| \rightarrow B_{|\Gamma L|}$. Since $\pi_* (|C^*(L; \Gamma L)|) = 0 = \pi_* (E_{|\Gamma L|})$, f is a weak homotopy equivalence.

(c) $|\Gamma L|$ as a model for the topological monoid, ΩX .

Suppose now that (L, d_L) is a Lie model for a simply connected CW complex, X . In particular we have a dga quasi-isomorphism

$$C^*(L, d_L) \xrightarrow{\cong} A_{PL}(X)$$

which in turn (Theorem 17.12) defines a rationalization $h_X : X \rightarrow |C^*L|$. Thus $\Omega h_X : \Omega X \rightarrow \Omega|C^*L|$ is a morphism of topological monoids and also induces an isomorphism of rational homotopy and homology (Theorem 8.6). We call such a morphism a *rational monoid equivalence*.

On the other hand suppose G is any topological group and $Z \xrightarrow{P} B$ is any principal G -bundle with $\pi_*(Z) = 0$. Then from Proposition 2.10 we obtain weak equivalences of topological monoids

$$G \xleftarrow{\cong} G \times_Z PZ \xrightarrow{\cong} \Omega B, \quad a \longleftarrow (a, w) \longmapsto p \circ w.$$

and corresponding weak equivalences of Serre fibrations

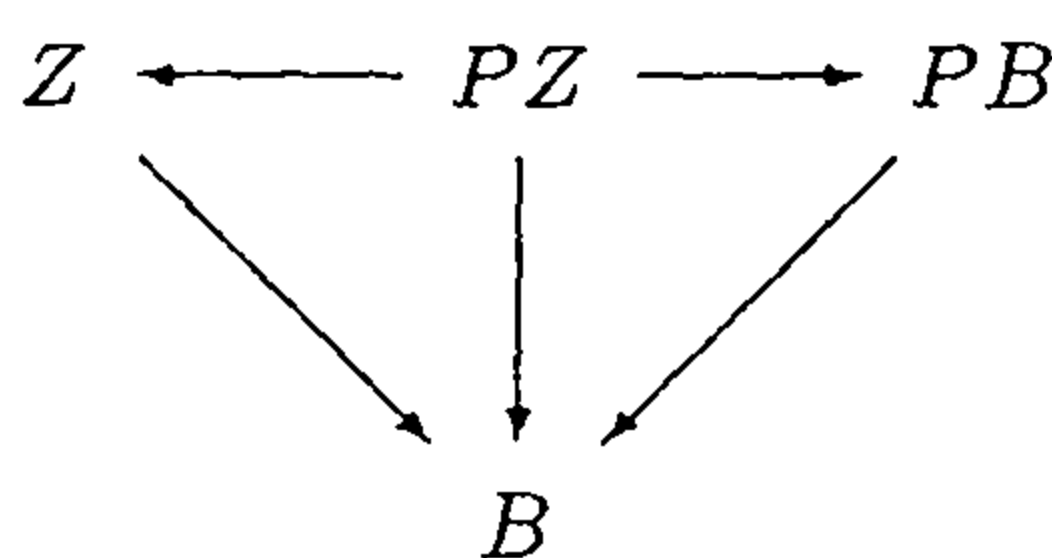

Thus here we have the chain of rational monoid equivalences

$$|\Gamma L| \xleftarrow{\cong} |\Gamma L| \times_{|C^*(L; \Gamma L)|} P|C^*(L; \Gamma L)| \xrightarrow{\cong} \Omega|C^*L| \xleftarrow{\Omega h_X} \Omega X \tag{25.3}$$

thereby exhibiting $|\Gamma L|$ as a ‘topological model’ for ΩX . We also have the corresponding (rational) equivalences of Serre fibrations

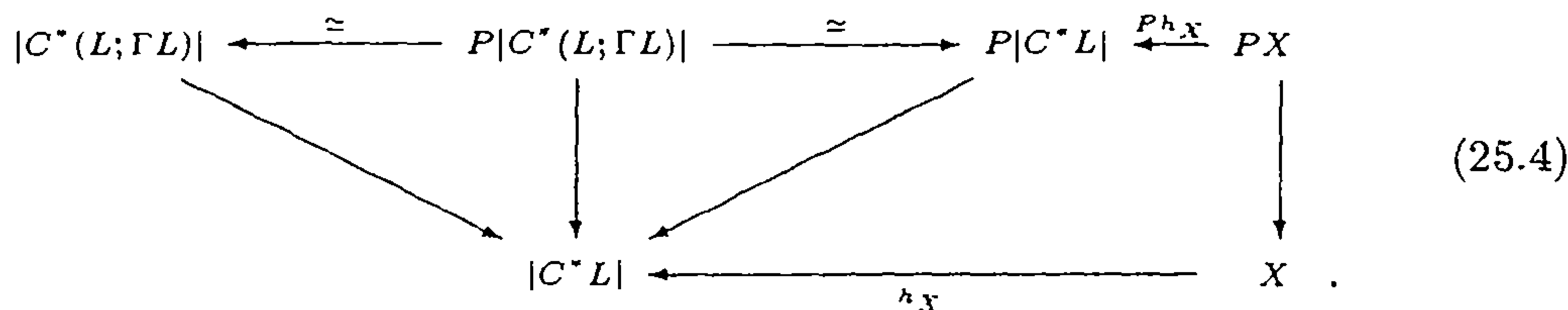

(d) Morphisms of chain Lie algebras and the holonomy action.

Suppose $\varphi : (L, d_L) \rightarrow (E, d_E)$ is a morphism of connected chain Lie algebras of finite type. Then $U\varphi : (UL, d_L) \rightarrow (UE, d_E)$ is a morphism of dg Hopf algebras. This is, in particular, a representation of (L, d_L) in (UE, d_E) , and therefore determines the chain complex $(C_*(L; UE), d)$ as described in §22(b).

This example has many of the additional properties of $C_*(L; UL)$. It, too, is a cocommutative differential graded coalgebra and a right (UE, d_E) -module, with the module action a dgc morphism. Moreover, $C_*(\varphi) : C_*(L, d_L) \rightarrow C_*(E, d_E)$ extends to the morphism of dgc's and UE -modules:

$$C_*(\varphi; id) : C_*(L; UE) \rightarrow C_*(E; UE) .$$

Now apply the spatial realization functor to the commutative cochain algebras (and morphisms of same) dual to these constructions. This gives the commutative diagram of continuous maps

$$\begin{array}{ccc} |C^*(L; \Gamma E)| & \xrightarrow{|C^*(\varphi; id)|} & |C^*(E; \Gamma E)| \\ \downarrow p & & \downarrow p_E \\ |C^*L| & \xrightarrow{|C^*\varphi|} & |C^*E| \end{array}$$

in which: p is a principal $|\Gamma E|$ -fibre bundle (exactly as in Proposition 25.2) and $|C^*(\varphi; id)|$ is a map of $|\Gamma E|$ -bundles. In particular, this exhibits p as the pullback of p_E via $|C^*\varphi|$.

On the other hand, the continuous map $|C^*\varphi|$ determines a holonomy fibration as described in §2(c), which is just the pullback via $|C^*\varphi|$ of the $\Omega|C^*E|$ fibration $P|C^*E| \rightarrow |C^*E|$. We may therefore apply Proposition 2.11 to obtain *equivariant weak equivalences of Serre fibrations*

$$\begin{array}{ccc} |C^*(L; \Gamma E)| & \xleftarrow{\cong} & P \xrightarrow{\cong} |C^*L| \times_{|C^*E|} P|C^*E| \\ & \searrow p & \downarrow \quad \swarrow \\ & & |C^*L| \end{array} \quad , \quad |\Gamma E| \xleftarrow{\cong} \Gamma \xrightarrow{\cong} \Omega|C^*E|$$

(25.5)

connecting the principal $|\Gamma E|$ -fibre bundle p with the holonomy fibration for $|C^*\varphi|$.

Finally, suppose $f : X \rightarrow Y$ is a continuous map between simply connected CW complexes with rational homology of finite type. Assume further that (L, d_L) and (E, d_E) are Lie models for X and for Y and that $\varphi : (L, d_L) \rightarrow$

(E, d_E) makes the diagram

$$\begin{array}{ccc}
 A_{PL}(Y) & \xrightarrow{A_{PL}(f)} & A_{PL}(X) \\
 \uparrow \simeq & & \uparrow \simeq \\
 C^*(E, d_E) & \xrightarrow{C^*(\varphi)} & C^*(L, d_L)
 \end{array} \tag{25.6}$$

homotopy commute in the sense of §12(b). In analogy with §25(c) we observe that the principal $|\Gamma E|$ -fibre bundle $p : |C^*(L; \Gamma E)| \rightarrow |C^*L|$ is equivariantly rationally equivalent to the holonomy fibration $X \times_Y PY \rightarrow X$.

In fact, the diagram (25.6) produces the homotopy commutative diagram

$$\begin{array}{ccc}
 X & \xrightarrow{f} & Y \\
 \downarrow h_X & & \downarrow h_Y \\
 |C^*L| & \xrightarrow{|C^*\varphi|} & |C^*E|
 \end{array}$$

(cf. §17(d)) in which h_X and h_Y are rationalizations. Regard the homotopy as a map Φ from X to the space of Moore paths in $|C^*E|$ of length 1, such that $(\Phi x)(0) = |C^*\varphi|h_X(x)$ and $(\Phi x)(1) = h_Y f(x)$. Then an equivariant rational equivalence

$$h : X \times_Y PY \rightarrow |C^*L| \times_{|C^*E|} P|C^*E|, \quad \Omega h_Y : \Omega Y \rightarrow \Omega |C^*E| \tag{25.7}$$

is given by $h(x, w) = (h_X x, \Phi(x) * h_Y \circ w)$. Combined with (25.5) above this provides the desired equivariant rational equivalence. \square

26 The dg Hopf algebra $C_*(\Omega X)$

In this section the ground ring is \mathbb{Q} ; as usual we simplify notation by writing $C_*(-)$ and $H_*(-)$ for $C_*(-; \mathbb{Q})$ and $H_*(-; \mathbb{Q})$.

Suppose given a free Lie model (\mathbb{L}_V, d) for a simply connected topological space X with rational homology of finite type. A natural isomorphism of graded Hopf algebras,

$$H(U\mathbb{L}_V, d) \xrightarrow{\cong} H_*(\Omega X) \quad (26.1)$$

is then described as follows. First, $H(U\mathbb{L}_V) = UH(\mathbb{L}_V)$, by Theorem 21.7. Next, $H(\mathbb{L}_V)$ is identified with the homotopy Lie algebra L_X by (24.2). Finally, the graded Hopf algebras UL_X and $H_*(\Omega X)$ are identified by the Milnor-Moore theorem 21.5.

The main objective of this section is to show (Theorem 26.5) that the isomorphism (26.1) is induced from a chain algebra quasi-isomorphism

$$\Theta : (U\mathbb{L}_V, d) \xrightarrow{\cong} C_*(\Omega X)$$

which commutes with the comultiplications up to dga homotopy (to be defined in §26(a)). This is a result of Majewski [119]. Its significance is due to a theorem of Anick [11] who showed directly the existence of a unique quasi-isomorphism class of free chain Lie algebras (\mathbb{L}, d) admitting such a quasi-isomorphism. However, these were potentially different from the Lie models constructed via Sullivan's functor A_{PL} as described here. Majewski's result shows that they coincide.

Our proof of Majewski's theorem is different from his, which takes a more abstract approach (permitting him to prove that other forms of introducing Lie models also produce the same answer). The idea of the proof here is as follows. In §25(c) we connected ΩX to a certain topological group, $|\Gamma\mathbb{L}_V|$, by rational monoid equivalences. This reduces the problem to constructing an appropriate quasi-isomorphism $(U\mathbb{L}_V, d) \xrightarrow{\cong} C_*|\Gamma\mathbb{L}_V|$. For this we use the integration map \int_* of §17(f).

Finally, at the end of this section, we consider continuous maps $f : X \rightarrow Y$ and prove an analogous theorem about the holonomy fibration.

This section is divided into the following topics:

- (a) Dga homotopy.
- (b) The dg Hopf algebra $C_*(\Omega X)$ and the statement of the theorem.
- (c) The chain algebra quasi-isomorphism $\theta : (U\mathbb{L}_V, d) \xrightarrow{\cong} C_*(\Gamma\mathbb{L}_V, \delta_L)$.
- (d) The proof of Theorem 26.5.

In carrying out these steps we shall make frequent use of the Alexander-Whitney and Eilenberg-Ziller chain equivalences

$$AW : C_*(- \times -) \xrightarrow{\cong} C_*(-) \otimes C_*(-) \quad \text{and} \quad EZ : C_*(-) \otimes C_*(-) \xrightarrow{\cong} C_*(- \times -)$$

defined in §4(b) for topological spaces. As observed in §17(f), these equivalences are defined for all simplicial sets, and we shall use them as such. In particular we shall quote the important properties (4.4)–(4.10) as if they had been stated for simplicial sets, since they hold in this wider context.

(a) Dga homotopy.

Suppose given a chain algebra of the form (TV, d) . Given two graded algebra morphisms $\varphi, \varphi' : TV \rightarrow A$ we say a linear map $\Phi : TV \rightarrow A$ is a (φ, φ') -derivation if

$$\Phi(xy) = \Phi x \cdot \varphi' y + (-1)^{\deg x \deg \Phi} \varphi x \cdot \Phi y, \quad x, y \in TV.$$

Any linear map $V \rightarrow A$ extends uniquely to a (φ, φ') -derivation.

Two chain algebra morphisms $\varphi, \varphi' : (TV, d) \rightarrow (A, d)$ are *dga homotopic* if

$$\varphi - \varphi' = d\Phi + \Phi d$$

for some (φ, φ') -derivation Φ , in which case we write $\varphi \sim \varphi'$. The derivation Φ is called a *dga homotopy*. Note that both sides of such an equation are themselves (φ, φ') -derivations. Thus in constructing a dga homotopy it is sufficient to verify that this equation holds in V .

Dga homotopy appears to be quite distinct from Sullivan’s homotopy described in §12(b). In fact the two are closely related, but we shall not pursue this here.

The following lifting lemma parallels all the others.

Lemma 26.2 *Suppose $\eta : (B, d) \xrightarrow{\cong} (A, d)$ is a chain algebra quasi-isomorphism. Then*

- (i) *For any chain algebra morphism $\varphi : (TV, d) \rightarrow (A, d)$ there is a morphism $\psi : (TV, d) \rightarrow (B, d)$ such that $\varphi \sim \eta\psi$.*
- (ii) *If $\psi, \psi' : (TV, d) \rightarrow (B, d)$ are morphisms satisfying $\eta\psi \sim \eta\psi'$ then $\psi \sim \psi'$.*

proof: (i) We construct ψ and a homotopy $\Phi : \varphi \sim \eta\psi$ by induction. Suppose they are defined in $T(V_{<n})$ and choose a basis $\{v_\alpha\}$ for V_n . Then the cycles ψdv_α satisfy $\eta(\psi dv_\alpha) = \varphi dv_\alpha - d\Phi dv_\alpha = d(\varphi v_\alpha - \Phi dv_\alpha)$. Since η is a quasi-isomorphism there are elements $b_\alpha \in B$ and $a_\alpha \in A$ such that $db_\alpha = \psi dv_\alpha$ and $\eta b_\alpha = \varphi v_\alpha - \Phi dv_\alpha + da_\alpha$. Extend ψ and Φ to V_n by setting $\psi v_\alpha = b_\alpha$ and $\Phi v_\alpha = a_\alpha$. Then ψ extends uniquely to an algebra morphism from $TV_{\leq n}$ and $\psi d = d\psi$ because this relation holds in $V_{\leq n}$. Similarly Φ extends uniquely to a $(\varphi, \eta\psi)$ -derivation from $TV_{\leq n}$ to B and $\varphi - \eta\psi = d\Phi + \Phi d$ because this relation holds in $V_{\leq n}$.

(ii) By hypothesis there is an $(\eta\psi, \eta\psi')$ -derivation Φ such that $\eta\psi - \eta\psi' = d\Phi + \Phi d$, and we seek to construct a (ψ, ψ') -derivation Ψ such that $\psi - \psi' = d\Psi + \Psi d$. Assume Ψ constructed in $V_{<n}$ so that $\eta\Psi - \Phi = d\Xi - \Xi d$ for some

$(\eta\psi, \eta\psi')$ -derivation Ξ . Again let $\{v_\alpha\}$ be a basis of V_n . Then $(\psi - \psi')v_\alpha - \Psi dv_\alpha$ is a cycle z_α in B , and $\eta z_\alpha = d\Phi v_\alpha - (\eta\Psi - \Phi)dv_\alpha = d(\Phi v_\alpha - \Xi dv_\alpha)$. Choose $b_\alpha \in B$ and $a_\alpha \in A$ so that $z_\alpha = db_\alpha$ and $\eta b_\alpha = \Phi v_\alpha - \Xi dv_\alpha + da_\alpha$. Then extend Ψ and Ξ by setting $\Psi v_\alpha = b_\alpha$ and $\Xi v_\alpha = a_\alpha$. \square

Lemma 26.3 Suppose $\chi : (TW, d) \rightarrow (TV, d) \begin{matrix} \xrightarrow{\varphi_0} \\ \xrightarrow{\varphi_1} \end{matrix} (A, d) \xrightarrow{\psi} (B, d)$ are morphisms of chain algebras.

- (i) If $\varphi_0 \sim \varphi_1$ then $H(\varphi_0) = H(\varphi_1)$.
- (ii) If $\varphi_0 \sim \varphi_1$ then $\psi\varphi_0 \sim \psi\varphi_1$ and $\varphi_0\chi \sim \varphi_1\chi$.
- (iii) Dga homotopy is an equivalence relation.

proof: (i) This is immediate from the equation $\varphi_0 - \varphi_1 = d\Phi + \Phi d$.

(ii) If Φ is a dga homotopy from φ_0 to φ_1 then $\psi\Phi$ is a dga homotopy from $\psi\varphi_0$ to $\psi\varphi_1$ and $\Phi\chi$ is a dga homotopy from $\varphi_0\chi$ to $\varphi_1\chi$.

(iii) *Reflexivity:* The zero map is a dga homotopy from φ_0 to φ_0 .

Symmetry: First construct a new dga (I, d) as follows. Let V' and V'' be graded vector spaces isomorphic with V and let sV be the suspension of V with suspension isomorphism $v \mapsto sv$. Put $I = T(V' \oplus V'' \oplus sV)$ and let $i', i'' : TV \rightarrow I$ be the algebra inclusions extending the linear isomorphisms $V \cong V', V''$. Let $S : TV \rightarrow I$ be the (i', i'') -derivation determined by $Sv = sv$. Finally, let d be the derivation of I determined by $di'v = i'dv, di''v = i''dv$ and $dsv = i'v - i''v - Sdv, v \in V$.

Next, verify in sequence the equations $di' = i'd, di'' = i''d, i' - i'' = dS + Sd$ and $d^2 = 0$, noting that it is sufficient to check each on the appropriate generating subspace. In particular (I, d) is a chain algebra, and i' and i'' are chain algebra morphisms.

Now suppose Φ is a dga homotopy from φ_0 to φ_1 . Define a dga morphism $\Omega : (I, d) \rightarrow (A, d)$ by $\Omega i' = \varphi_0, \Omega i'' = \varphi_1$ and $\Omega sv = \Phi v$. We show that $i'' \sim i'$ and conclude that $\varphi_1 = \Omega i'' \sim \Omega i' = \varphi_0$.

For this define a dga morphism $\rho : (I, d) \rightarrow (TV, d)$ by $\rho i' = id = \rho i''$ and $\rho sv = 0$. If i' is a quasi-isomorphism then so is ρ and hence Lemma 26.2 will give $i'' \sim i'$.

It remains to show that i' is a quasi-isomorphism. Let $W = (i' - i'')(V)$. Then $I = T(V' \oplus W \oplus sV)$. Moreover the ideal \mathcal{I} generated by W and sV is preserved by d . Since $I = TV' \oplus \mathcal{I}$ we need only show $H(\mathcal{I}) = 0$. For this use multiplication in I to write $\mathcal{I} = TV' \otimes (W \oplus sV) \otimes I$. Define $h : \mathcal{I} \rightarrow \mathcal{I}$ by

$$h(\Phi \otimes x \otimes \Psi) = \begin{cases} (-1)^{\deg \Phi} \Phi \otimes sv \otimes \Psi & , x = i'v - i''v , \\ 0 & , x \in sV . \end{cases}$$

Then a straightforward computation shows that $hd + dh - id$ sends $TV' \otimes W \otimes I$ into $TV' \otimes sV \otimes I$ and sends $TV' \otimes sV \otimes I$ to zero. It follows that $H(\mathcal{I}) = 0$ and i' is a quasi-isomorphism.

Transitivity: Extend (I, d) to a chain algebra (J, d) as follows. Set $J = T(V' \oplus V'' \oplus V''' \oplus sV \oplus \bar{s}V)$ where V''' is a third copy of V and $\bar{s}V$ is a second copy of the suspension of V . Regard i', i'' and S as maps into J , let $i''' : TV \rightarrow J$ be the algebra inclusion extending the isomorphism $V \cong V'''$ and extend $\bar{s} : V \xrightarrow{\cong} \bar{s}V$ to an (i'', i''') -derivation $\bar{S} : TV \rightarrow J$. Define d in J by requiring $di''' = i'''d$ and $d\bar{s}v = i''v - i'''v - \bar{S}dv, v \in V$.

Now suppose $\varphi_0 \sim \varphi_1 : (TV, d) \rightarrow (A, d)$ and $\varphi_1 \sim \varphi_2 : (TV, d) \rightarrow (A, d)$ are dga homotopic by homotopies Φ and Φ' . Define a chain algebra morphism $\bar{\Omega} : (J, d) \rightarrow (A, d)$ by $\bar{\Omega}i' = \varphi_0, \bar{\Omega}i'' = \varphi_1, \bar{\Omega}i''' = \varphi_2, \bar{\Omega}sv = \Phi v$ and $\bar{\Omega}\bar{s}v = \Phi'v$. Define a chain algebra morphism $\pi : (J, d) \rightarrow (TV, d)$ by $\pi i' = \pi i'' = \pi i''' = id$ and $\pi sv = \pi \bar{s}v = 0, v \in V$. As in the proof of symmetry, π is a quasi-isomorphism and so Lemma 26.2 implies that $i' \sim i'''$. It follows that $\varphi_0 = \bar{\Omega}i' \sim \bar{\Omega}i''' = \varphi_2$. □

(b) The dg Hopf algebra $C_*(\Omega X)$ and the statement of the theorem.

Let (X, x_0) be a based topological space, and recall (§2(b)) that ΩX is the topological monoid of Moore loops at x_0 . Multiplication $\Omega X \times \Omega X \rightarrow \Omega X$ is given by composition of loops and the identity is the constant loop c at x_0 . Now suppose G is any topological monoid with multiplication, μ , and identity, c . Then, as observed in the introduction to §16 for $G = \Omega X$,

$$\mu_{\text{alg}} = C_*(\mu) \circ EZ : C_*(G) \otimes C_*(G) \rightarrow C_*(G)$$

makes $C_*(G)$ into a chain algebra. On the other hand (§4(b)) the Alexander-Whitney diagonal

$$\Delta_{\text{alg}} = AW \circ C_*(\Delta_{\text{top}}) : C_*(G) \rightarrow C_*(G) \otimes C_*(G)$$

makes $C_*(G)$ into a differential graded coalgebra, where Δ_{top} denotes the topological diagonal sending $y \mapsto (y, y)$.

Proposition 26.4 *The maps μ_{alg} and Δ_{alg} make $C_*(G)$ into a differential graded Hopf algebra with identity and augmentation given by*

$$k = C_*(\{c\}) \rightarrow C_*(G) \quad \text{and} \quad C_*(G) \rightarrow C_*(pt) = k .$$

proof: This is a straightforward calculation using properties (4.4)–(4.9). In particular, the fact that Δ_{alg} is a morphism of chain algebras follows from the compatibility (4.9) of AW and EZ . □

On the other hand, suppose (\mathbb{L}_V, d) is a free Lie model for a simply connected topological space X with rational homology of finite type (cf. §24). Then $U(\mathbb{L}_V, d)$ is a differential graded Hopf algebra of the form (TV, d) , whose comultiplication is the chain algebra morphism $\Delta_U : (TV, d) \rightarrow (TV, d) \otimes (TV, d)$ defined by $\Delta_U v = v \otimes 1 + 1 \otimes v$, $v \in V$ (§21(c), (f)). Our main theorem reads

Theorem 26.5 *Let X be a simply connected topological space with rational homology of finite type. The choice of a free Lie model (\mathbb{L}_V, d) for X determines a natural homotopy class of chain algebra quasi-isomorphisms*

$$\Theta : U(\mathbb{L}_V, d) \xrightarrow{\cong} C_*(\Omega X)$$

such that $(\Theta \otimes \Theta)\Delta_U$ and $\Delta_{\text{alg}} \circ \Theta$ are dga homotopic. Moreover $H(\Theta)$ is the isomorphism (26.1).

Remark Suppose (\mathbb{L}_V, d) is a cellular Lie model (§24(c)) for a simply connected CW complex X with rational homology of finite type. The quasi-isomorphism of Theorem 26.5 has the form

$$(TV, d) \xrightarrow{\cong} C_*(\Omega X),$$

because $U\mathbb{L}_V = TV$ (§21(c)). Moreover V is free on a basis corresponding to the cells of X .

This is therefore a special case of the classical Adams-Hilton model [2]. This model, and the de Rham algebra of differential forms on a manifold, were the first uses of differential graded algebras as a tool in homotopy theory. \square

(c) The chain algebra quasi-isomorphism $\theta : (U\mathbb{L}_V, d) \xrightarrow{\cong} C_*(\Gamma\mathbb{L}_V, \delta_L)$.

Fix an arbitrary free connected chain Lie algebra (\mathbb{L}_V, d) of finite type. In §25(a) we constructed a topological group $|\Gamma\mathbb{L}_V, \delta_L|$ as follows. First, we let $(\Gamma\mathbb{L}_V, \delta_L)$ be the commutative graded Hopf algebra dual to $U\mathbb{L}_V$. Thus the multiplication μ_Γ and the comultiplication Δ_Γ are respectively dual to the comultiplication Δ_U and the multiplication μ_U in $U\mathbb{L}_V$. Then we applied the spatial realization functor of §17(c) to obtain $|\Gamma\mathbb{L}_V, \delta| = |\langle \Gamma\mathbb{L}_V, \delta_L \rangle|$ with multiplication $|\Delta_\Gamma|$ and topological diagonal $|\mu_\Gamma|$ (cf. Proposition 25.1). Since (\mathbb{L}_V, d) is fixed in this discussion we shall abbreviate the dg Hopf algebra $(\Gamma\mathbb{L}_V, \delta_L)$ to Γ so that our topological group is simply denoted by $|\Gamma|$.

As observed in Proposition 26.4, $C_*|\Gamma|$ is a dg Hopf algebra with multiplication $C_*(|\Delta_\Gamma|) \circ EZ$ and comultiplication $AW \circ C_*(|\mu_\Gamma|)$. However, included in $C_*|\Gamma|$ is the sub dgc $C_*\langle \Gamma \rangle$, as defined in §17(a). Since EZ and AW are defined in the wider context of simplicial sets (§17(f)), $C_*\langle \Gamma \rangle$ is a sub dg Hopf algebra of $C_*|\Gamma|$, with multiplication $\mu_{\text{alg}} = C_*\langle \Delta_\Gamma \rangle \circ EZ$ and comultiplication $\Delta_{\text{alg}} = AW \circ C_*\langle \mu_\Gamma \rangle$.

Now recall from §17(f) the natural morphism of chain complexes $\int_* : C_*\langle \Lambda V, d \rangle \rightarrow C_{(\Lambda V, d)}$, dual to the integration operator \oint defined in §10(e). In the case of $(\Gamma\mathbb{L}_V, \delta_L)$ it takes the form

$$\int_* : C_*\langle \Gamma \rangle \rightarrow (U\mathbb{L}_V, d),$$

since Γ is the dual of UL_V .

Proposition 26.6 *The map $\int_* : C_*(\Gamma) \rightarrow (UL_V, d)$ is a chain algebra quasi-isomorphism.*

proof: Proposition 17.16 asserts that \int_* is a quasi-isomorphism. Proposition 17.17 asserts that

$$\begin{array}{ccc}
 C_*(\Gamma) \otimes C_*(\Gamma) & \xrightarrow{\int_* \otimes \int_*} & UL_V \otimes UL_V \\
 \searrow EZ & & \nearrow \int_* \\
 & & C_*(\Gamma \otimes \Gamma)
 \end{array}$$

commutes. But the multiplication $|\Delta_\Gamma|$ in $|\Gamma|$ is the realization of Δ_Γ which is the dual of the multiplication μ_U in UL_V . Thus for $\sigma, \tau \in \langle \Gamma \rangle$,

$$\int_* \sigma \cdot \tau = \int_* C_*(\Delta_\Gamma)EZ(\sigma \otimes \tau) = \mu_U \int_* EZ(\sigma \otimes \tau) = \int_* \sigma \cdot \int_* \tau . \quad \square$$

Recall now (§21(c)) that the universal enveloping algebra (UL_V, d) is, as a chain algebra, the tensor algebra (TV, d) . Thus we may apply Lemma 26.2 to the chain algebra quasi-isomorphism $\int_* : C_*(\Gamma) \rightarrow (TV, d)$ to obtain a chain algebra quasi-isomorphism

$$\theta : (UL_V, d) \xrightarrow{\cong} C_*(\Gamma) ,$$

uniquely determined up to dga homotopy by the requirement that $\int_* \circ \theta \sim id$.

Lemma 26.7 *The quasi-isomorphism θ commutes with the comultiplications in UL_V and in $C_*(\Gamma)$ up to dga homotopy.*

proof: We have to show that

$$(\theta \otimes \theta)\Delta_U \sim AW \circ C_*(\Delta_{top}) \circ \theta .$$

Now here Δ_{top} is just $\langle \mu_\Gamma \rangle$, where μ_Γ is the dual of Δ_U . Consider the (non-commutative) diagram

$$\begin{array}{ccccc}
 C_*(\Gamma) \otimes C_*(\Gamma) & \xrightarrow{EZ} & C_*(\Gamma \otimes \Gamma) & \xrightarrow{\int_*} & UL_V \otimes UL_V \\
 \uparrow \Delta_{alg} & & \uparrow C_*(\mu_\Gamma) & & \uparrow \Delta_U \\
 C_*(\Gamma) & \xrightarrow{id} & C_*(\Gamma) & \xrightarrow{\int_*} & UL_V .
 \end{array}$$

Observe first that

$$C_*(\Gamma) \otimes C_*(\Gamma) \xrightarrow{EZ} C_*(\Gamma \otimes \Gamma) \xrightarrow{AW} C_*(\Gamma) \otimes C_*(\Gamma)$$

are dga morphisms, as follows easily from property (4.7) and (4.8) for EZ and from property (4.9) for AW . Moreover (Proposition 4.10) these are quasi-isomorphisms, and $AW \circ EZ = id$. In particular,

$$AW \circ C_*\langle\mu_\Gamma\rangle \circ \theta = \Delta_{\text{alg}} \circ \theta = AW \circ EZ \circ \Delta_{\text{alg}} \circ \theta .$$

Since AW is a chain algebra quasi-isomorphism we may apply Lemma 26.2(ii) to conclude that $C_*\langle\mu_\Gamma\rangle \circ \theta \sim EZ \circ \Delta_{\text{alg}} \circ \theta$.

Finally, note that the right hand square in the diagram above commutes by naturality. Thus

$$\Delta_U \sim \Delta_U \circ \int_* \circ \theta \sim \int_* \circ C_*\langle\mu_\Gamma\rangle \circ \theta \sim \int_* \circ EZ \circ \Delta_{\text{alg}} \circ \theta .$$

The diagram in the proof of Proposition 26.6 allows us to replace $\int_* \circ EZ$ by $\int_* \otimes \int_*$:

$$\Delta_U \sim \int_* \otimes \int_* \circ \Delta_{\text{alg}} \circ \theta .$$

Thus, since $\int_* \theta \sim id$,

$$\int_* \otimes \int_* \circ \theta \otimes \theta \circ \Delta_U \sim \Delta_U \sim \int_* \otimes \int_* \circ \Delta_{\text{alg}} \circ \theta .$$

But \int_* is a quasi-isomorphism. Apply Lemma 26.2 to obtain

$$\theta \otimes \theta \circ \Delta_U \sim \Delta_{\text{alg}} \circ \theta . \quad \square$$

(d) The proof of Theorem 26.5.

We are given a free Lie model (\mathbb{L}_V, d) for a simply connected topological space X , which means that we have specified a cochain algebra quasi-isomorphism

$$m : C^*(\mathbb{L}_V, d) \xrightarrow{\cong} A_{PL}(X) .$$

For simplicity of notation we shall denote (\mathbb{L}_V, d) simply by L .

Suppose first X is a CW complex. Recall that $\Gamma = (\Gamma L, \delta)$ denotes the dg Hopf algebra $\text{Hom}(UL, \mathbb{k})$. Apply C_* to the chain (25.3) of rational monoid equivalences to obtain the chain

$$C_*\langle\Gamma\rangle \rightarrow C_*|\Gamma| \leftarrow C_*(\bullet) \rightarrow C_*\Omega|C^*L| \xleftarrow{C_*\Omega h_X} C_*(\Omega X) \quad (26.8)$$

of dg Hopf algebra quasi-isomorphisms.

Next, recall that $UL = TV$, and use Lemma 26.2 to lift the quasi-isomorphism

$$\theta : (UL, d) \xrightarrow{\cong} C_*\langle\Gamma\rangle$$

of §26(c) through this chain to obtain a chain algebra quasi-isomorphism

$$\Theta : (UL, d) \xrightarrow{\cong} C_*(\Omega X) .$$

It commutes up to dga homotopy with the comultiplications because θ does (Lemma 26.7) and because the quasi-isomorphisms in (26.8) commute with the comultiplications. Moreover θ is uniquely determined up to dga homotopy and hence, so is Θ (Lemma 26.2). Since \int_* is natural and the homotopy class of h_X is natural in X (Theorem 17.15) so is the homotopy class of Θ .

Now we have to show that $H(\Theta)$ coincides with the isomorphism (26.1). We may clearly suppose $X = |C^*L|$, $h_X = id$ and

$$m : C^*L \xrightarrow{\cong} A_{PL}|C^*L|$$

is one of the canonical homotopy class of morphisms (specified in §17(d)). Since $H(UL) = UH(L)$ it is enough to show these isomorphisms agree on $[v]$ for any cycle $v \in L$. Thus by naturality we are reduced to the case $L = (\mathbb{L}(v), 0)$ is the free Lie algebra on a single generator of degree n .

In this case the isomorphism (26.1) sends v to the unique homology class corresponding to $[sv]$ under the isomorphisms

$$H_n(\Omega|C^*L|) \xleftarrow{\cong} H_{n+1}(P|C^*L|, \Omega|C^*L|) \xrightarrow{\cong} H_{n+1}(|C^*L|) .$$

But $H(\Theta)$ has the same effect (use the fibrations (25.4) and a simple calculation in $C_*(L; \Gamma L)$). \square

Exercise

Determine a chain algebra quasi-isomorphism $\theta : (TV, d) \rightarrow C_*(\Omega X)$ when X is a wedge of spheres S^{n_i} , $n_i \geq 2$. Deduce from this the Hopf algebra structure of $H_*(\Omega X; \mathbb{Q})$.

Part V

Rational Lusternik Schnirelmann Category

27 Lusternik-Schnirelmann category

In this section the ground ring is an arbitrary commutative ring \mathbb{k} , unless otherwise specified.

A subspace Z of a topological space X is *contractible in X* if the inclusion $i : Z \rightarrow X$ is homotopic to a constant map $Z \rightarrow x_0$.

Definition The *LS category* of X , denoted $\text{cat } X$, is the least integer m (or ∞) such that X is the union of $m + 1$ open subsets U_i , each contractible in X .

Remark LS category was originally introduced in [116], where it was shown that $\text{cat } X + 1$ is a lower bound for the number of critical points of any smooth function on a closed manifold X . The original definition differs from the one above by 1; however the definition above has become standard in homotopy theory because, clearly, $\text{cat } X = 0$ if and only if X is contractible. Note that it follows that

$$\text{cat } S^n = 1, \quad n \geq 0.$$

Moreover if $x_\alpha \in X_\alpha$ has a neighbourhood contractible to x_α in X_α then

$$\text{cat} \left(\bigvee_{\alpha} X_{\alpha} \right) = \max_{\alpha} \{ \text{cat } X_{\alpha} \}$$

as is immediate from the definition.

This section is devoted to some of the basic geometric properties of LS category. (For other presentations the reader is referred to [96], [62] and [40].) For example, in §27(a) we shall prove that $\text{cat } X \leq d/r$ for an d -dimensional $(r - 1)$ -connected CW complex, and in §27(f) we shall see that if cohomology classes $\alpha_i \in H^+(X; \mathbb{k})$ satisfy $\alpha_1 \cup \cdots \cup \alpha_n \neq 0$, then $\text{cat } X \geq n$. Now $\mathbb{C}P^n$ is a 1-connected CW complex of dimension $2n$ whose rational cohomology algebra has the form $\mathbb{k}[\alpha]/\alpha^{n+1}$ where $\alpha \in H^2(\mathbb{C}P^n; \mathbb{Q})$. It follows that $n \leq \text{cat } \mathbb{C}P^n \leq 2n/2$; i.e.

$$\text{cat } \mathbb{C}P^n = n.$$

An identical argument shows that the LS category of any simply connected symplectic manifold X (Example 5, §12(e)) is half the dimension.

However, our focus in this section is on a number of useful characterisations of the inequality $\text{cat } X \leq m$, including:

- deformation of the diagonal of X^{m+1} into the fat wedge (Whitehead).
- existence of a cross-section of the m^{th} Ganea fibration (Ganea).
- retraction of X from an m -cone (Ganea).
- $X \vee \Sigma Y$ is an m -cone (Cornea).

LS category is an invariant of homotopy type, but it is particularly difficult to compute. For this reason it is useful to approximate it by other invariants. Thus we introduce the cup-length, $c(X; \mathbb{k})$ and Toomer's invariant, $e(X; \mathbb{k})$, which are more algebraic in nature, as well as the geometric cone-length $\text{cl } X$ which is the least m (or ∞) such that X has the homotopy type of an m -cone. We shall show that

$$c(X; \mathbb{k}) \leq e(X; \mathbb{k}) \leq \text{cat } X \leq \text{cl } X .$$

In this section we shall make heavy use of cones and suspensions. Thus we recall (§1(f)) that the cone on a topological space X is the space $CX = X \times I / X \times \{0\}$, and that the points (x, t) are usually denoted by tx , $0 \leq t \leq 1$, with $0x$ the cone point. This identifies $X = X \times \{1\}$ as a subspace of CX . If $g : A \rightarrow X$ is any continuous map the adjunction space $X \cup_g CA$ is called the *cofibre of g* .

Next define the *reduced cone* on a based space (X, x_0) to be the space $\overline{CX} = CX / Ix_0$. Then the suspension of X is the based space $\Sigma X = \overline{CX} / X$. If (X, x_0) is well-based then (CX, Ix_0) is an NDR pair, the quotient map $CX \rightarrow \overline{CX}$ is a homotopy equivalence (Corollary to Theorem 1.13) and (\overline{CX}, x_0) and ΣX are well-based. If, in addition, X is path connected a simple van Kampen argument shows that ΣX is simply connected. Furthermore the long exact homology sequence associated with the pair (\overline{CX}, X) gives rise to natural isomorphisms

$$H_i(\Sigma X; \mathbb{k}) \xrightarrow{\cong} H_{i-1}(X; \mathbb{k}) , \quad i \geq 2 .$$

We shall use all these facts freely without further reference.

This section is organized into the following topics:

- (a) LS category of spaces and maps.
- (b) Ganea's fibre-cofibre construction.
- (c) Ganea spaces and LS category.
- (d) Cone-length and LS category: Ganea's theorem.
- (e) Cone-length and LS category: Cornea's theorem.
- (f) Cup-length, $c(X; \mathbb{k})$ and Toomer's invariant, $e(X; \mathbb{k})$.

(a) LS category of spaces and maps.

The definition of LS category extends from spaces to continuous maps as follows:

Definition The *LS category of a continuous map $f : X \rightarrow Y$* , denoted $\text{cat } f$, is the least integer m (or ∞) such that X is the union of $m + 1$ open sets U_i for which the restriction of f to each U_i is homotopic to a constant map $U_i \rightarrow y_i$.

Note that

$$\text{cat } X = \text{cat } id_X$$

so that this is a generalisation of the LS category of a space.

We say a topological space X is a *homotopy retract* of a topological space Y if there are continuous maps $X \xrightarrow{f} Y \xrightarrow{g} X$ such that $gf \sim id_X$.

Lemma 27.1 *Suppose $f : X \rightarrow Y$ is a continuous map.*

- (i) *If $f' \sim f$ then $\text{cat } f' = \text{cat } f$.*
- (ii) *If $g : Y \rightarrow Z$ is continuous then $\text{cat } gf \leq \min(\text{cat } g, \text{cat } f)$.*
- (iii) *If g (resp. f) is a homotopy equivalence then $\text{cat } gf = \text{cat } f$ (resp. $\text{cat } gf = \text{cat } g$).*
- (iv) $\text{cat } f \leq \min(\text{cat } X, \text{cat } Y)$.
- (v) *If X is a homotopy retract of Y then $\text{cat } X \leq \text{cat } Y$.*

proof: (i) and (ii) are trivial consequences of the definitions. For (iii) suppose g' is a homotopy inverse for g . Then $g'gf \sim f$ and so $\text{cat } f = \text{cat } g'gf \leq \text{cat } gf \leq \text{cat } f$. Similarly if f' is a homotopy inverse for f then $\text{cat } g = \text{cat } gff' \leq \text{cat } gf \leq \text{cat } g$. (iv) follows from (iii) applied to $id_Y \circ f$ and $f \circ id_X$ and (v) is immediate from (i), (ii) and (iv). □

As an immediate consequence of Lemma 27.1 (v) we deduce

Proposition 27.2 *If X and Y have the same homotopy type then $\text{cat } X = \text{cat } Y$.* □

Lemma 27.3 *For any continuous map $g : A \rightarrow X$,*

$$\text{cat}(X \cup_g CA) \leq \text{cat } X + 1 .$$

proof: Let $\text{cat } X = m$ and put $\bar{a} = [A \times \{0\}] \in CA$. Then $X \cup_g CA - \{\bar{a}\}$ is an open subset of $X \cup_g CA$ containing X as a deformation retract. Hence $\text{cat}(X \cup_g CA - \{\bar{a}\}) = m$ and $X \cup_g CA - \{\bar{a}\} = \bigcup_0^m U_i$ with U_i open and contractible in $X \cup_g CA$. Since $CA - A$ is open and contractible in $X \cup_g CA$ it follows that $\text{cat}(X \cup_g CA) \leq m + 1$. □

Next consider a based topological space (X, \bar{x}) and denote its $(m + 1)$ -fold product by $X^{m+1} = X \times \dots \times X$. The *fat wedge*, $T^{m+1}X \subset X^{m+1}$ is the subspace given by $T^{m+1}(X) = \{(x_0, \dots, x_m) \in X^{m+1} \mid \text{some } x_i = \bar{x}\}$. The *diagonal*, $\Delta_X : X \rightarrow X^{m+1}$, is the continuous map $\Delta_X : x \mapsto (x, x, \dots, x)$.

Definition The *Whitehead category* of X , denoted $\text{Wh cat } X$, is the least integer m (or ∞) such that Δ_X is homotopic to a map $f : X \rightarrow T^{m+1}(X)$.

Proposition 27.4 [158] *Suppose (X, \bar{x}) is path connected*

(i) *If X is normal then $\text{Wh cat } X \leq \text{cat } X$.*

(ii) *If \bar{x} is contained in a subspace U that is open and contractible in X then $\text{cat } X \leq \text{Wh cat } X$.*

proof: (i) Let $m = \text{cat } X$ so that $X = \bigcup_0^m U_i$ with U_i open and contractible in X . Because X is normal there are subspaces $A_i \subset O_i \subset B_i \subset U_i$ with A_i, B_i closed and O_i open and $X = \bigcup_i A_i$, and there are continuous functions $h_i : X \rightarrow I$ such that $h_i|_{A_i} \equiv 1$ and $h_i|_{X-B_i} \equiv 0$.

Let $H_i : U_i \times I \rightarrow X$ be a homotopy from the inclusion of U_i to a constant map. Because X is path connected we may suppose $H_i(-, 1) : U_i \rightarrow \bar{x}$. Define $K_i : X \times I \rightarrow X$ by

$$K_i(x, t) = \begin{cases} x & , \quad x \in X - B_i \\ H_i(x, h_i(x)t) & , \quad x \in U_i . \end{cases}$$

Then $K_i(-, 1) : A_i \rightarrow \bar{x}$ and so

$$K : X \times I \rightarrow X^{m+1} , \quad K(x, t) = (K_0(x, t), \dots, K_m(x, t))$$

is a homotopy from Δ to a map $X \rightarrow T^{m+1}(X)$.

(ii) Let $m = \text{Wh cat}(X)$ and let $K(x, t) = (K_0(x, t), \dots, K_m(x, t))$ be a homotopy from Δ to a map $f = (f_0, \dots, f_m) : X \rightarrow T^{m+1}(X)$. Set $U_i = f_i^{-1}(U)$. Then $X = \bigcup_0^m U_i$. Moreover K_i is a homotopy from the inclusion of U_i to the map $f_i : U_i \rightarrow U$. Since U is contractible in X it follows that U_i is contractible in X too. □

Corollary *If X is a path connected CW complex then*

$$\text{cat } X = \text{Wh cat } X .$$

proof: By Proposition 1.1 (iv) and (v), X satisfies the two additional hypotheses of Proposition 27.4. □

Recall next that a topological space X is q -connected if $\pi_i(X) = 0, 0 \leq i \leq q$.

Proposition 27.5 *Suppose X is an $(r - 1)$ -connected CW complex of dimension d (some $r \geq 1$) Then*

$$\text{cat } X \leq d/r .$$

proof: It follows from the construction of Theorem 1.4 that there is a weak homotopy equivalence $g : Y \xrightarrow{\simeq} X$ where Y is a CW complex whose $(r - 1)$ -skeleton is a single 0-cell, y_0 . By Corollary 1.7 this is a homotopy equivalence, and hence has a homotopy inverse $f : X \xrightarrow{\simeq} Y$.

Let m be the integer part of d/r , and recall from Example 3, §1(a) that Y^{m+1} is a CW complex whose k -cells are the products $D_{\alpha_0}^{k_0} \times \dots \times D_{\alpha_m}^{k_m}$ of cells in Y with $\sum k_i = k$. Since $d < (m + 1)r$, the d -skeleton of Y^{m+1} is contained in $T^{m+1}(Y)$. In particular, a cellular approximation (Theorem 1.2) of the map $\Delta_f = (f, \dots, f) : X \rightarrow Y^{m+1}$ is a map $h : X \rightarrow T^{m+1}(Y)$ such that $\Delta_f \sim h$.

Finally, since $gf \sim id$, $g \times \dots \times g \circ \Delta_f \sim \Delta_X$, Δ_X the diagonal of X . Thus $\Delta_X \sim (g \times \dots \times g)h : X \rightarrow T^{m+1}(X)$. By the Corollary to Proposition 27.4, $\text{cat } X \leq m$. □

(b) Ganea’s fibre-cofibre construction.

Suppose (X, x_0) is a based space and let $j : F \rightarrow E$ be the inclusion of the fibre at x_0 of a fibration

$$p : E \rightarrow X .$$

Extend p to the continuous map (cf. §1(f))

$$p_C : E \cup_j CF \rightarrow X$$

by setting $p_C(CF) = x_0$.

Then (§2(c)) convert p_C to the fibration

$$p' : E' \rightarrow X$$

defined by $E' = (E \cup_j CF) \times_X MX$ and $p'(z, \gamma) = \gamma(\ell)$, ℓ the length of the path γ . According to Proposition 2.5, a homotopy equivalence $\lambda : E \cup_j CF \xrightarrow{\simeq} E'$ is given by $\lambda z = (z, c_{p_C z})$, c_x denoting the path of length zero at x . Note that $p'\lambda = p_C$. Precomposing λ with the inclusion of E gives the commutative diagram

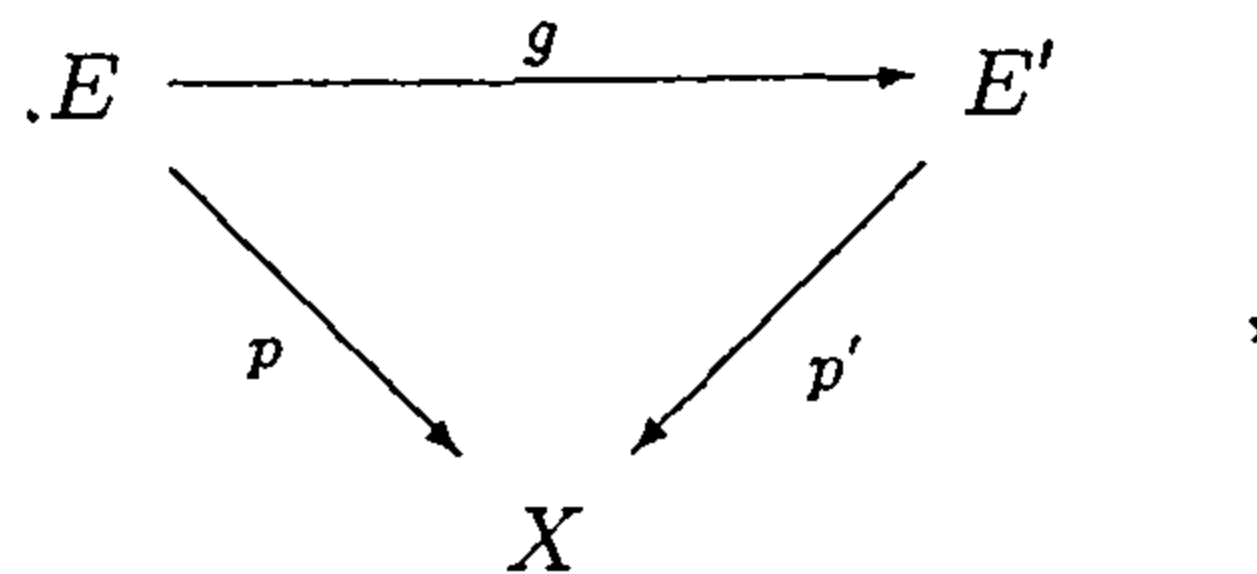

which is called Ganea’s *fibre-cofibre construction*. It is obviously functorial with respect to maps of fibrations.

Now consider the special case that $p : E \rightarrow X$ is itself obtained by converting a continuous map $f : Z \rightarrow X$ into a fibration, so that

$$E = Z \times_X MX \quad \text{and} \quad F = Z \times_X PX .$$

Thus a holonomy action is defined on F as well as on the fibre F' of p' . Recall further from §1(f) that the join $F * \Omega X$ is defined by

$$F * \Omega X = (F \times C\Omega X) \cup_{F \times \Omega X} (CF \times \Omega X) .$$

Right multiplication in ΩX and the holonomy action in F define a *diagonal action* of ΩX on $F * \Omega X$ ($(u, v) \cdot g = (ug, vg)$). More generally an ΩX -space is a topological space equipped with a right ΩX action and a map of ΩX -spaces is a continuous map that commutes with the actions.

Proposition 27.6 (*Ganea [63]*)

- (i) *The fibre F' of p' at x_0 has the homotopy type of $F * \Omega X$.*
- (ii) *If p is obtained as above by converting a map f to a fibration then there is a homotopy equivalence $F' \xrightarrow{\cong} F * \Omega X$ which is also a map of ΩX -spaces.*

proof: (i) By construction,

$$F' = (E \cup_j CF) \times_X PX = (E \times_X PX) \cup_i (CF \times \Omega X) ,$$

i denoting the inclusion of $F \times \Omega X$ in $E \times_X PX$.

Now in the proof of Proposition 2.5 (with different notation) we constructed a continuous map $\Phi : E \times_X PX \times [0, \infty) \rightarrow E$ such that $p\Phi(z, \gamma, t) = \gamma(t)$ and $\Phi(z, \gamma, 0) = z$. For $\gamma \in \Omega X$ let $\bar{\gamma}$ be the loop of length ℓ_γ given by $\bar{\gamma}(t) = \gamma(\ell_\gamma - t)$. Define $K : F \times \Omega X \times I \rightarrow E \times_X PX$ by setting

$$K(y, \gamma, t) = (\Phi(y, \bar{\gamma}, t\ell_\gamma), \gamma'_t)$$

where γ has length ℓ_γ and γ'_t is the path of length $t\ell_\gamma$ given by $\gamma'_t(s) = \gamma((1-t)\ell_\gamma + s)$. Then K factors to give a map $\bar{K} : F \times C\Omega X \rightarrow E \times_X PX$. Moreover, by construction $\bar{K}(y, \gamma, 1) = (y', \gamma)$ where $y' = \Phi(y, \bar{\gamma}, \ell_\gamma) \in F$. Thus it extends to the map

$$(\bar{K}, f) : (F \times C\Omega X) \cup_{F \times \Omega X} (CF \times \Omega X) \rightarrow (E \times_X PX) \cup_i (CF \times \Omega X) = F' ,$$

where $f(ty, \gamma) = (ty', \gamma)$ is obviously a homotopy equivalence.

But formula (1.15) identifies $(F \times C\Omega X) \cup_{F \times \Omega X} (CF \times \Omega X)$ as $F * \Omega X$. Moreover, if c_{x_0} denotes the loop of length 0 at x_0 then \bar{K} restricts to the inclusion $F \times \{c_{x_0}\} \times \{1\} \rightarrow E \times_X PX$, and this inclusion is a homotopy equivalence by Proposition 2.5. Thus \bar{K} is a homotopy equivalence and hence Theorem 1.13 asserts that so is (\bar{K}, f) .

(ii) As above, $F' = (E \times_X PX) \cup_i (CF \times \Omega X)$, with ΩX acting by multiplication on the right. Observe that composition of paths defines a homotopy equivalence $MX \times_X PX \xrightarrow{\cong} PX$. This extends to a homotopy equivalence

$E \times_X PX = Z \times_X MX \times_X PX \xrightarrow{\cong} Z \times_X PX = F$ and hence (Theorem 1.13) to a homotopy equivalence

$$\varphi : F' \xrightarrow{\cong} F \cup_a (CF \times \Omega X) ,$$

where $a : F \times \Omega X \rightarrow F$ is the action of ΩX .

If $\gamma \in \Omega X$ has length ℓ define $\gamma' \in \Omega X$ to be the loop of the same length satisfying $\gamma'(t) = \gamma(\ell - t)$. Then $\gamma \mapsto \gamma'$ is a homeomorphism and the maps $\gamma \mapsto \gamma \cdot \gamma'$, $\gamma \mapsto \gamma' \cdot \gamma$ are homotopic to the constant map. It follows that a homotopy equivalence $m : CF \times \Omega X \rightarrow CF \times \Omega X$ is defined by $(y, \gamma) \mapsto (y\gamma, \gamma)$. Denote by $q_0 : F \times \Omega X \rightarrow F$ and $q_1 : F \times \Omega X \rightarrow \Omega X$ the projections. Then $q_1 \cdot m = a$ and so (Theorem 1.13)

$$id \cup m : F \cup_a (CF \times \Omega X) \xrightarrow{\cong} F \cup_{q_0} (CF \times \Omega X)$$

is a homotopy equivalence.

By inspection the homotopy equivalence $(id \cup m) \circ \varphi : F' \xrightarrow{\cong} F \cup_{q_0} (CF \times \Omega X)$ converts the action of ΩX in F' to the diagonal action in $CF \times \Omega X$. Since

$$F \cup_{q_0} (CF \times X) = F \cup_{q_0} (I \times F \times \Omega X) \cup_{q_1} \Omega X = F * \Omega X ,$$

the proof is complete. □

(c) Ganea spaces and LS category.

Fix a based path connected topological space, (X, x_0) . Start with the path space fibration, and iterate the fibre-cofibre construction to produce a sequence of fibrations

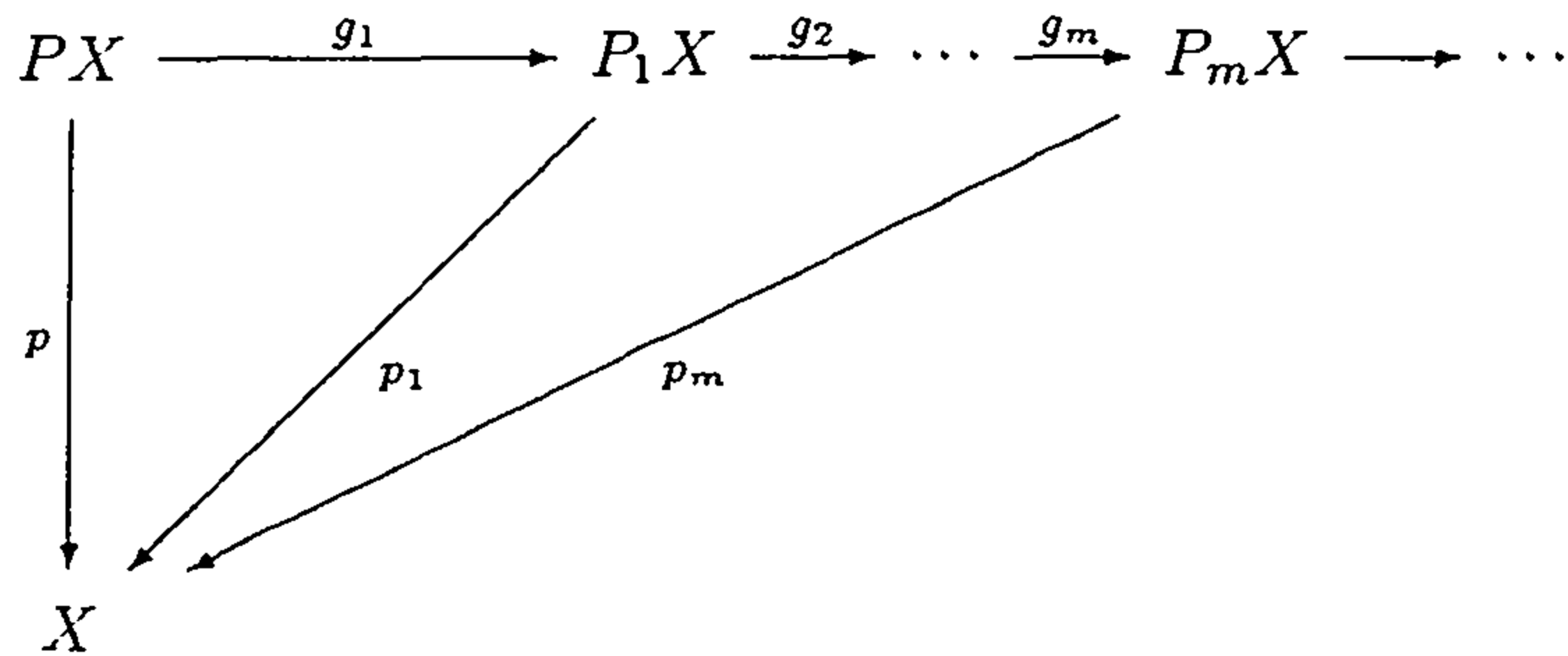

The space P_mX is called the m^{th} Ganea space for X and p_m is called the m^{th} Ganea fibration. We set $P_0X = PX$, $p_0 = p$ and we denote the inclusion of the fibre of p_n at x_0 by $j_m : F_m \rightarrow P_mX$. Thus $F_0 = \Omega X$ and (Proposition 27.6) $F_n \simeq (\Omega X)^{*n+1}$.

Note also that if $f : (Y, y_0) \rightarrow (X, x_0)$ is a continuous map of based path connected spaces then the functoriality of the Ganea construction gives commutative diagrams

$$\begin{array}{ccc}
 P_m Y & \xrightarrow{P_m f} & P_m X \\
 p_m^Y \downarrow & & \downarrow p_m^X \\
 Y & \xrightarrow{f} & X
 \end{array}
 \quad , m \geq 0 ,$$

in which $P_0f = Pf$.

Notice that

$$\text{cat } P_m X \leq m . \tag{27.7}$$

Indeed, since $P_m X \simeq P_{m-1} X \cup_{j_{m-1}} CF_{m-1}$ we have

$$\text{cat } P_m X = \text{cat } (P_{m-1} X \cup_{j_{m-1}} CF_{m-1}) \leq \text{cat } P_{m-1} X + 1 ,$$

by Proposition 27.2 and Lemma 27.3 respectively. Since $P_0 X = PX$ is contractible, (27.7) follows by induction.

Proposition 27.8 (Ganea [62]) *The following conditions are equivalent on a continuous map $f : Y \rightarrow X$ from a normal space Y :*

- (i) $f = p_m \sigma$ for some continuous $\sigma : Y \rightarrow P_m X$.
- (ii) $f \sim p_m \sigma$ for some continuous $\sigma : Y \rightarrow P_m X$.
- (iii) $\text{cat } f \leq m$.

proof: (i) \iff (ii): Suppose $q : E \rightarrow X$ is any fibration and $h_E : W \rightarrow E$, $h_X : W \rightarrow X$ are arbitrary continuous maps such that $qh_E \sim h_X$. Lift the homotopy starting at h_E to obtain $h_E \sim h$ with $qh = h_X$. In particular (i) \iff (ii).

(ii) \implies (iii): If (ii) holds apply Lemma 27.1 to conclude $\text{cat } f = \text{cat } p_m \sigma \leq \text{cat } p_m \leq \text{cat } P_m X$. Since $\text{cat } P_m X \leq m$ by (27.7) it follows that $\text{cat } f \leq m$.

(iii) \implies (ii): Denote the constant map by $c_Y : Y \rightarrow \{x_0\}$. If $\text{cat } f = 0$ then $f \sim c_Y$, which certainly factors through p_0 . Suppose $\text{cat } f \leq m$, some $m \geq 1$. Then $Y = \bigcup_{i=0}^m U_i$, where the U_i are open and $f|_{U_i} \sim c_Y|_{U_i}$. Since Y is normal there are open subspaces $V_0, V_1 \subset Y$ such that $Y = V_0 \cup V_1$ and such that the closures A and B of V_0 and V_1 satisfy $A \subset \bigcup_{i=0}^{m-1} U_i$ and $B \subset U_m$. Denote $f|_A$ and $c_Y|_A$ by f_A and c_A . Clearly $\text{cat } f_A \leq m - 1$. Since A is closed it is normal and so we may suppose by induction (because (i) \iff (ii)) that $f_A = p_{m-1} \sigma_A$ for some $\sigma_A : A \rightarrow P_{m-1} X$. On the other hand, since $B \subset U_m$ there is a homotopy $H_B : B \times I \rightarrow X$ from $f|_B$ to $c_Y|_B$.

Now construct a continuous map

$$\varphi : A \times \{0\} \cup (A \cap B \times I) \cup B \times \{1\} \rightarrow P_{m-1} X \cup CF_{m-1} ,$$

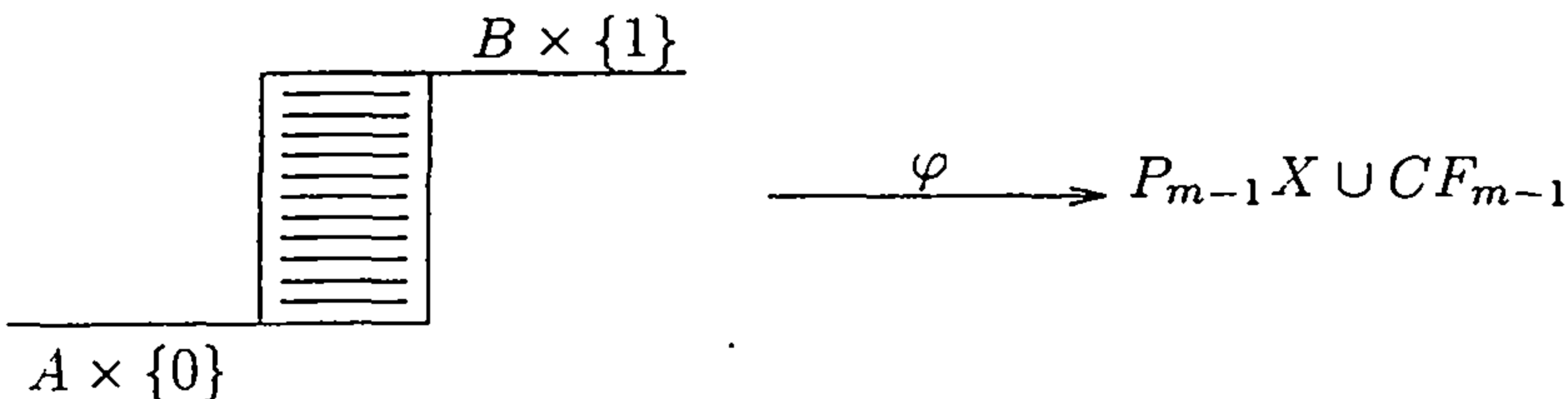

as follows. First, set $\varphi|_{A \times \{0\}} = \sigma_A$. Next, recall (§1(f)) that the points in CF_{m-1} are denoted by tz , $t \in I$, $z \in F_{m-1}$. Let v_0 be the cone point: $v_0 = 0z$ for all $z \in F_{m-1}$. Lift H_B to a homotopy $H : A \cap B \times I \rightarrow P_{m-1}X$ from $\sigma_A|_{A \cap B}$ to a map $A \cap B \rightarrow F_{m-1}$. Define $\varphi|_{A \cap B \times I}$ by

$$\varphi(y, t) = \begin{cases} H(y, 2t) & , \quad 0 \leq t \leq \frac{1}{2} . \\ 2(1-t)H(y, 1) & , \quad \frac{1}{2} \leq t \leq 1 . \end{cases}$$

Finally, set $\varphi(B \times \{1\}) = v_0$.

Since Y is normal there is a continuous function $h : Y \rightarrow I$ such that $h(Y - V_1) = 0$ and $h(Y - V_0) = 1$. Then $y \mapsto (y, h(y))$ defines a continuous map $\alpha : Y \rightarrow A \times \{0\} \cup (A \cap B \times I) \cup B \times \{1\}$. Set

$$\sigma = \varphi \circ \alpha : Y \rightarrow P_{m-1}X \cup CF_{m-1} \hookrightarrow P_mX .$$

It remains to show that $p_m\sigma \sim f$. Note that $p_m(CF_{m-1}) = x_0$. Thus $p_m\varphi$ extends to the continuous map $\psi : Y \times \{0\} \cup B \times I \rightarrow X$ given by $\psi(y, 0) = fy$ and, for $y \in B$,

$$\psi(y, t) = \begin{cases} H_B(y, 2t) & , \quad 0 \leq t \leq \frac{1}{2} \\ x_0 & , \quad \frac{1}{2} \leq t \leq 1 . \end{cases}$$

The obvious deformation of $Y \times \{0\} \cup B \times I$ to $Y \times \{0\}$ provides a homotopy from $p_m\varphi\alpha = \psi\alpha$ to f . □

Corollary *If X is a normal topological space then $\text{cat } X \leq m$ if and only if there is a continuous map $\sigma : X \rightarrow P_mX$ such that $p_m\sigma = \text{id}_X$.* □

(d) Cone-length and LS category: Ganea's theorem.

The *iterated suspensions* $\Sigma^k X$ of a based topological space X are defined inductively by

$$\Sigma^0 X = X \quad \text{and} \quad \Sigma^k X = \Sigma(\Sigma^{k-1} X) , \quad k \geq 1 .$$

They appear in the

Definition An n -cone is a based topological space (P, p_0) presented in the form

$$\{p_0\} = P_0 \subset P_1 \subset \dots \subset P_n = P$$

where

$$P_{k+1} = P_k \cup_{h_k} \overline{C}\Sigma^k Y_k , \quad k \geq 0 ,$$

for a sequence of well-based spaces (Y_k, y_k) and continuous maps $h_k : (\Sigma^k Y_k, y_k) \rightarrow (P_k, x_0)$. The (Y_k, y_k) are the *constituent spaces* of the cone and the h_k are the *attaching maps*.

Remark 1 A simple van Kampen argument shows that if (P, x_0) is an n -cone with path-connected constituent spaces then each P_k (including P itself) is simply connected.

Remark 2 Note that $P_1 = \Sigma Y_0$, and so the 1-cones are simply the suspensions.

Remark 3 An n -cone is automatically well-based since each $(\overline{C}\Sigma^k Y_k, \Sigma^k Y_k)$ is an NDR pair.

In §1(a) we introduced a homeomorphism $\Sigma S^k \cong S^{k+1}$. In the same way we have $\overline{C}S^k \cong D^{k+1}$. Thus an n -dimensional CW complex X with a single 0-cell, no 1-cells and based attaching maps $h_k : \bigvee_{\alpha} S_{\alpha}^k \rightarrow X_k$ is a special case of an n -cone:

$$X_{k+1} = X_k \cup_{h_k} \left(\bigvee_{\alpha} D_{\alpha}^{k+1} \right) = X_k \cup_{h_k} \left(\overline{C} \bigvee_{\alpha} S_{\alpha}^k \right).$$

Definition The *cone-length*, $\text{cl } X$, of a topological space X is the least n (or ∞) such that X has the homotopy type of an n -cone.

In this topic we establish two main results.

Proposition 27.9 (Ganea [63]) *If (X, x_0) is well-based then each Ganea space $P_n X$ has the homotopy type of an n -cone with constituent spaces $Y_k = (\Omega X)^{\wedge k+1}$. In particular, if X is simply connected so is each $P_m X$.*

Theorem 27.10 (Ganea [62]) *If X is normal then*

$$\text{cat } X \leq m \iff X \text{ is a homotopy retract of an } m\text{-cone.}$$

In particular,

$$\text{cat } X \leq \text{cl } X.$$

Remark A recent result of Dupont shows that, even rationally, this inequality can be strict; he constructs a rational CW complex X with $\text{cat } X = 3$ and $\text{cl } X = 4$.

proof of Proposition 27.9: Recall that $p_n : P_n X \rightarrow X$ denotes the n^{th} Ganea fibration (§27(c)) and that the fibre inclusion at x_0 is denoted by $j_n : F_n \rightarrow P_n X$. Let c_{x_0} denote the loop of length zero at x_0 .

Step 1: $(\Omega X, c_{x_0})$ is well-based.

Choose a continuous $h : X \rightarrow I$, an open set $x_0 \in U \subset X$ and a homotopy rel x_0 , $H : U \times I \rightarrow X$ from the inclusion of U to the constant map $U \rightarrow x_0$, such that $h^{-1}(0) = x_0$ and $h^{-1}([0, \varepsilon]) \subset U$. Define a continuous function $k :$

$\Omega X \rightarrow I$ by $k(\gamma) = \ell_\gamma + \sup \{h(\gamma t) \mid t \in [0, \infty)\}$, ℓ_γ denoting the length of γ . Let $V \subset \Omega X$ be the open set of loops of length < 1 that lie entirely in U . If $\gamma \in V$ let γ_t be the loop of length ℓ_t given by

$$\gamma_t(s) = \begin{cases} H(\gamma(s), 2t) & , \quad 0 \leq t \leq \frac{1}{2} . \\ x_0 & , \quad \frac{1}{2} \leq t \leq 1 . \end{cases} \quad \ell_t = \begin{cases} \ell_\gamma & , \quad 0 \leq t \leq \frac{1}{2} . \\ (2 - 2t)\ell_\gamma & , \quad \frac{1}{2} \leq t \leq 1 . \end{cases}$$

Then k, V and $K : (\gamma, t) \mapsto (\gamma_t, \ell_t)$ exhibit $(\Omega X, c_{x_0})$ as well-based.

Step 2: The smash products $(\Omega X)^{\wedge k} = \Omega X \wedge \cdots \wedge \Omega X$ (k times) are well-based and $\Sigma^n(\Omega X)^{\wedge n+1} \simeq F_n$.

proof: If (A, a_0) and (B, b_0) are well-based then $(A \times B, A \times \{b_0\} \cup \{a_0\} \times B)$ is an NDR pair (Proposition 1.9). Hence $A \wedge B$ is well-based. It follows by induction starting with Step 1 that $(\Omega X)^{\wedge k}$ is well-based. On the other hand, $F_n \simeq F_{n-1} * \Omega X$, as follows from Proposition 27.6. Since $F_0 = \Omega X$ and since for well-based spaces $A * B \simeq \Sigma(A \wedge B) \simeq A \wedge \Sigma B$ we have (by induction) that

$$F_n \simeq (\Omega X)^{*(n+1)} = (\Omega X) * (\Omega X)^{*n} \simeq \Omega X * \Sigma^{n-1}((\Omega X)^{\wedge n}) \simeq \Sigma^n((\Omega X)^{\wedge n+1}) .$$

Step 3: $P_n X$ has the homotopy type of an n -cone with constituent spaces $Y_k = (\Omega X)^{\wedge k+1}$.

Recall from §27(c) that $P_0 X = PX \simeq \{pt\}$ and that $P_n X \simeq P_{n-1} X \cup_{j_{n-1}} CF_{n-1}$. Choose $h : \Sigma^{n-1}(\Omega X)^{\wedge n} \xrightarrow{\simeq} F_{n-1}$ (Step 2) and (by induction) $f : P_{n-1} X \xrightarrow{\simeq} Z$, where Z is an $(n-1)$ -cone with constituent spaces $Y_k = (\Omega X)^{\wedge k+1}$. Set $g = fj_{n-1}h$. Then Theorem 1.13 asserts that the maps

$$P_{n-1} X \cup_{j_{n-1}} CF_{n-1} \xrightarrow{(f, id)} Z \cup_{fj_{n-1}} CF_{n-1} \xleftarrow{(id, Ch)} Z \cup_g C\Sigma^{n-1}(\Omega X)^{\wedge n}$$

are homotopy equivalences. Moreover, since $\Sigma^{n-1}(\Omega X)^{\wedge n}$ is well-based $C\Sigma^{n-1}(\Omega X)^{\wedge n} \xrightarrow{\simeq} \overline{C}\Sigma^{n-1}(\Omega X)^{\wedge n}$ and so, finally $P_{n-1} X \cup_{j_{n-1}} CF_{n-1} \simeq Z \cup_h \overline{C}\Sigma^{n-1}(\Omega X)^{\wedge n}$, for some continuous $h : \Sigma^{n-1}(\Omega X)^{\wedge n} \rightarrow Z$. Since the homotopy type of an adjunction space only depends on the homotopy class of the adjoining map (Lemma 1.12) we may take h to be a based map. \square

proof of Theorem 27.10: Reduce to the case of well-based spaces (X, x_0) by replacing X by $X \cup_x [0, 1]$ and setting $x_0 = 1$. If X is a homotopy retract of an m -cone P then $\text{cat } X \leq \text{cat } P$ (Lemma 27.1(v)) and $\text{cat } P \leq m$ (induction using Lemma 27.3). Conversely, if $\text{cat } X \leq m$ then X is a retract of $P_m X$ (Corollary to Proposition 27.8) which has the homotopy type of an m -cone (Proposition 27.9). The final assertion of the Theorem follows immediately from this equivalence. \square

(e) Cone-length and LS category: Cornea’s theorem.

The purpose of this topic is to establish Cornea’s remarkable strengthening of Theorem 27.10:

Theorem 27.11 (Cornea [40]) *If X is a normal topological space then*

$$\text{cat } X \leq m \iff X \vee \Sigma Y \text{ has the homotopy type of an } m\text{-cone} \\ \text{for some } m - 1 \text{ connected space } Y.$$

Remark In fact, Cornea shows that there is an m -cone of the form $X \vee \Sigma^m Y'$ and deduces that $\text{cl } X \leq \text{cat } X + 1$. We will not prove this refinement here since rationally it is immediate and since it requires a result from homotopy theory not included in the text.

In proving Theorem 27.11 we shall need to identify spaces as having the homotopy type of n -cones. For this we shall rely heavily on the following.

Basic Facts:

- *If (Y, A) is an NDR pair then the homotopy type of $Z \cup_f Y$ depends only on the homotopy class of $f : A \rightarrow Z$ (Lemma 1.12).*
- *If (Y', A') is a second NDR pair and if $f : A' \rightarrow Z'$ then compatible homotopy equivalences $(Z, Y, A) \rightarrow (Z', Y', A')$ induce a homotopy equivalence $Z \cup_A Y \xrightarrow{\cong} Z' \cup_{A'} Y'$ (Theorem 1.13).*
- *If (Y, A) is an NDR pair and A is contractible then the quotient map $Y \rightarrow Y/A$ is a homotopy equivalence (Corollary to Theorem 1.13).*

□

Now suppose

$$q : E \rightarrow B$$

is a fibration with fibre inclusion $j : F \rightarrow E$ at some base point $b_0 \in B$. The key step in the proof of Theorem 27.11 is

Proposition 27.12 *Suppose B has the homotopy type of an n -cone with constituent spaces Y_k . Then $E \cup_j CF$ has the homotopy type of an n -cone whose k^{th} constituent space has the homotopy type of $(Y_k \times F) \cup CF$.*

proof:

Step 1: Reduction to the case that B is an n -cone.

Let $g : Z \rightarrow B$ be a homotopy equivalence from an n -cone Z with constituent spaces Y_k . Then (Z, z_0) is well-based. Since B is path connected we may replace g with a homotopic based map; i.e. we may assume $g : (Z, z_0) \rightarrow (B, b_0)$.

In the pullback diagram

$$\begin{array}{ccc} Z \times_B E & \xrightarrow{g_E} & E \\ q_Z \downarrow & & \downarrow q \\ Z & \xrightarrow{g} & B \end{array}$$

g_E is a homotopy equivalence because g is (Proposition 2.3). By our second ‘Basic Fact’ above, $(Z \times_B E) \cup_j CF \xrightarrow{\cong} E \cup_j CF$; i.e. we may assume $B = Z$ is an n -cone with constituent spaces Y_k .

Write $B = W \cup_f \overline{C}A$ where (W, w_0) is an $(n - 1)$ -cone with constituent spaces $Y_k, k < n, (A, a_0) = (\Sigma^n Y_n, y_n)$ and $f : (A, a_0) \rightarrow (W, w_0)$. Let $q : E_W \rightarrow W$ be the restriction of the fibration q to W .

Step 2. There is a homotopy equivalence of the form

$$E_W \cup_\theta (\overline{C}A \times F) \xrightarrow{\cong} E$$

in which $\theta : A \times F \rightarrow E_W$ restricts to j in $\{a_0\} \times F$.

Let $(\varphi, f) : (\overline{C}A, A) \rightarrow (B, W)$ be the canonical map, and use it to pull the original fibration back to a pair of fibrations

$$\begin{array}{ccc} (\overline{C}A, A) \times_B E & \xrightarrow{(\varphi_E, f_E)} & (E, E_W) \\ \downarrow (p, p_A) & & \downarrow q \\ (\overline{C}A, A) & \xrightarrow{(\varphi, f)} & (B, W), \end{array}$$

noting that (φ_E, f_E) is projection on (E, E_W) and (p, p_A) is projection on $(\overline{C}A, A)$. The fibre of p at a_0 is just $j' = \{a_0\} \times j : \{a_0\} \times F \rightarrow \overline{C}A \times_B E$. Since $\overline{C}A$ is contractible, Proposition 2.3 asserts that j' is a homotopy equivalence.

Now let $p^L : \overline{C}A \times F \rightarrow \overline{C}A$ and $p^R : \overline{C}A \times F \rightarrow F$ be the projections, and consider the (non-commutative) diagram

$$\begin{array}{ccc} \overline{C}A \times F & \xrightarrow{j' p^R} & \overline{C}A \times_B E \\ & \searrow p^L & \swarrow p \\ & \overline{C}A & \end{array}$$

We construct a new map $h : \overline{C}A \times F \rightarrow \overline{C}A \times_B E$ such that $ph = p^L, h|_{\{a_0\} \times F} = j'$ and both h and its restriction $h_A : A \times F \rightarrow A \times_B E$ are homotopy equivalences. For this we recall (Proposition 2.1) that a fibration has the lifting property with respect to any DR pair and in particular with respect to a pair of the form $(Y \times I, Y \times \{0\} \cup Y' \times I)$ where (Y, Y') is an NDR pair. We also recall (Proposition 2.3) that the pullback of a fibration over an NDR pair is an NDR pair.

Choose a based homotopy $H : \overline{C}A \times I \rightarrow \overline{C}A$ from the constant map $\overline{C}A \rightarrow \{a_0\}$ to $id_{\overline{C}A}$. Lift $H \circ (p^L \times id_I)$ to a homotopy rel $\{a_0\} \times F$ starting at $j' p^R$. Define h to be the restriction of this homotopy to $\overline{C}A \times F \times \{1\}$. Then $ph = p^L$ and so h restricts to $h_A : A \times F \rightarrow A \times_B F$. Also h restricts to j' in $\{a_0\} \times F$ and so h is a homotopy equivalence.

It remains to show h_A is a homotopy equivalence. As above, modify an arbitrary homotopy inverse of h to obtain a homotopy inverse h' satisfying $p^L h' = p$. Let $p' : \overline{CA} \times I \rightarrow \overline{CA}$ be the projection. If K is a homotopy from hh' to $id_{\overline{CA} \times_B E}$, then there is a homotopy $rel \overline{CA} \times_B E \times \{0, 1\}$ from pK to $p'(p \times id_I)$ because \overline{CA} is contractible. Lift this to obtain $K \sim K' rel \overline{CA} \times_E B \times \{0, 1\}$. Then K' is a homotopy from hh' to $id_{\overline{CA} \times_B E}$ and $pK' = p'(p \times id_I)$. In particular K' restricts to a homotopy $h_A h'_A \sim id_{A \times_B E}$. Similarly, $h'_A h_A \sim id_{A \times_B F}$.

Now set $\theta = f_E h_A : A \times F \rightarrow E_W$. Since (trivially) $E = E_W \cup_{f_E} (\overline{CA} \times_B E)$ our second 'Basic Fact' gives

$$(id, h) : E_W \cup_{\theta} (\overline{CA} \times F) \xrightarrow{\cong} E_W \cup_{f_E} (\overline{CA} \times_B E) = E .$$

Step 3: Completion of the proof of the proposition.

Recall the notation established at the end of Step 1. Since the map h of Step 2 restricts to j' in $\{a_0\} \times F$ it follows that $\theta = f_E h_A$ restricts to $j : \{a_0\} \times F \rightarrow E$. Extend θ by id_{CF} to a map $g : A \times F \cup \{a_0\} \times CF \rightarrow E_W \cup_j CF$. By our second 'Basic Fact' we may adjoin CF to both sides of the homotopy equivalence of Step 2 and still have a homotopy equivalence. This may be written in the form

$$(E_W \cup_j CF) \cup_g (\overline{CA} \times F \cup \{a_0\} \times CF) \xrightarrow{\cong} E \cup_j CF .$$

By induction $E_W \cup_j CF$ has the homotopy type of an $(n-1)$ -cone, (D, d_0) with constituent spaces of the homotopy type of $Y_k \times F \cup CF$, $k \leq n-1$. Use the second 'Basic Fact' to obtain

$$D \cup_{g'} (\overline{CA} \times F \cup \{a_0\} \times CF) \simeq E \cup_j CF ,$$

for a suitable map $g' : A \times F \cup \{a_0\} \times CF \rightarrow D$. Choose a well-based space F' of the same homotopy type of F (e.g. $F' = F \cup_y [0, 1]$). Then

$$\overline{CA} \times F \cup \{a_0\} \times CF \simeq \overline{CA} \times F' \cup \{a_0\} \times CF' \simeq \overline{CA} \times F' / \{a_0\} \times F' .$$

Thus our 'Basic Facts' give a homotopy equivalence of the form

$$D \cup_k (\overline{CA} \times F' / \{a_0\} \times F') \simeq E \cup_j CF ,$$

where $k : A \times F' / \{a_0\} \times F' \rightarrow D$ is a based map.

Finally, recall (§1(f)) that the points of \overline{CA} are denoted by ta , $t \in I$, $a \in I$. Define a homeomorphism $\overline{CA} \times F' / \{a_0\} \times F' \xrightarrow{\cong} \overline{C}(A \times F' / \{a_0\} \times F')$ by $(ta, y) \mapsto t(a, y)$. Dividing by $A \times F' / \{a_0\} \times F'$ on the left yields a homeomorphism $\Sigma A \times F' / \{a_0\} \times F' \xrightarrow{\cong} \Sigma(A \times F' / \{a_0\} \times F')$. Thus

$$D \cup_k (\overline{CA} \times F' / \{a_0\} \times F') = D \cup_k \overline{C}(A \times F' / \{a_0\} \times F')$$

and

$$A \times F' / \{a_0\} \times F' = \Sigma^{n-1} Y_{n-1} \times F' / \{a_0\} \times F' \cong \Sigma^{n-1} (Y_{n-1} \times F' / \{a_0\} \times F') .$$

Since $Y_{n-1} \times F' / \{a_0\} \times F' \simeq Y_{n-1} \times F' \cup CF' \simeq Y_{n-1} \times F \cup CF$, the inductive step is complete. \square

proof of Theorem 27.11: If $X \vee \Sigma Y$ has the homotopy type of an m -cone then X is a homotopy retract of an m -cone and $\text{cat } X \leq m$ (Theorem 27.10).

Conversely, suppose $\text{cat } X \leq m$. Then there is a continuous map $\sigma : X \rightarrow P_m X$ such that $p_m \sigma = id_X$ (Corollary to Proposition 27.8). Convert σ to the fibration $q : X \times_{P_m X} M(P_m X) \rightarrow P_m X$ as described in §2(c). Denote $X \times_{P_m X} M(P_m X)$ by E and denote the inclusion of the fibre of q by $j : F \rightarrow E$. Since $P_m X$ has the homotopy type of an m -cone (Proposition 27.9) it follows that $E \cup_j CF$ has the homotopy type of an m -cone too (Proposition 27.12). On the other hand, as observed in §2(c) there is a homotopy equivalence $\lambda : X \xrightarrow{\cong} E$ such that $q\lambda = \sigma$. Let λ' be a homotopy inverse for λ . Then $\lambda p_m q \sim \lambda p_m \sigma \lambda' = \lambda \lambda' \sim id_E$. Hence $j \sim \lambda p_m q j$, which is a constant map. By our first basic fact $E \cup_j CF \simeq E \vee CF/F$. But $CF/F \simeq \Sigma Y$ for any well pointed space Y homotopy equivalent to F . Thus

$$X \vee \Sigma Y \simeq E \vee \Sigma Y \simeq E \cup_j CF ,$$

and $E \cup_j CF$ has the homotopy type of an m -cone.

Finally, it is relatively easy to show that $F \simeq \Omega F_m$. However, here we simply notice that since $p_m \sigma = id_X$ it follows that $\pi_*(P_m X) \cong \pi_*(X) \oplus \pi_*(F_m)$. Moreover $\pi_*(q)$ is an isomorphism of $\pi_*(E)$ onto the subgroup identified with $\pi_*(X)$. It follows that the connecting homomorphism for the fibration q maps $\pi_*(F_m)$ isomorphically onto $\pi_{*-1}(F)$. Since $F_m \simeq \Sigma^m(\Omega X)^{\wedge m+1}$ and ΩX is path connected we may conclude that F_m is simply connected and that $H_i(F_m) = 0$, $1 \leq i \leq m$. By the Hurewicz theorem 4.19, F_m is m -connected. Hence F and Y are $m - 1$ connected. \square

Again, consider a fibration

$$q : E \rightarrow B$$

with fibre inclusion $j : F \rightarrow E$ at some base point $b_0 \in B$. From Proposition 27.12 we deduce

Proposition 27.13 *If B is normal then*

$$\text{cl}(E \cup_j CF) \leq \text{cl } B \quad \text{and} \quad \text{cat}(E \cup_j CF) \leq \text{cat } B .$$

proof: The first assertion is immediate from Proposition 27.12. For the second, let $\text{cat } B = m$. Then B is a homotopy retract of an m -cone P (Theorem 27.10). If $B \xrightarrow{f} P \xrightarrow{r} B$ satisfy $rf \sim id_B$ then the homotopy lifts to a homotopy

$h \sim id_E$ such that $qh = rf$. Thus we have maps of fibrations

$$\begin{array}{ccccc}
 E & \xrightarrow{(fq,h)} & P \times_B E & \xrightarrow{\text{proj}} & E \\
 \downarrow q & & \downarrow \text{proj} & & \downarrow q \\
 B & \xrightarrow{f} & P & \xrightarrow{r} & B
 \end{array}$$

which exhibit $E \cup CF$ as a homotopy retract of $(P \times_B E) \cup CF$. Since P is an m -cone so is $(P \times_B E) \cup CF$, by Proposition 27.12, and so $\text{cat } E \cup CF \leq m$. \square

Example 1 *The LS category of the Ganea spaces $P_n X$.*

Suppose X is a normal topological space with $\text{cat } X = m, m < \infty$. We show that

$$\text{cat } P_n X = \begin{cases} n & \text{if } n \leq m \\ m & \text{if } n \geq m. \end{cases}$$

In fact, since $P_{n+1} X \simeq P_n X \cup CF_n$ it follows that $\text{cat } P_{n+1} X \leq \text{cat } P_n X + 1$ (Lemma 27.3). On the other hand, X is a retract of $P_m X$ (Corollary to Proposition 27.8) and thus $\text{cat } P_m X \geq \text{cat } X = m$. Since $P_0 X$ is contractible $\text{cat } P_0 X = 0$ and now the first inequality implies $\text{cat } P_n X = n, n \leq m$.

On the other hand, Proposition 27.13 gives $\text{cat } P_n X \leq \text{cat } X$, all n . Thus since X is a retract of $P_n X, n \geq m$ we have $\text{cat } X \leq \text{cat } P_n X \leq \text{cat } X, n \geq m. \square$

(f) Cup-length, $c(X; \mathbb{k})$ and Toomer's invariant, $e(X; \mathbb{k})$.

The *cup-length*, $c(X; \mathbb{k})$, of a path connected topological space X is the greatest integer n such that there are cohomology classes $\alpha_1, \dots, \alpha_n \in H^+(X; \mathbb{k})$ such that $\alpha_1 \cup \dots \cup \alpha_n \neq 0$. *Toomer's invariant*, $e(X; \mathbb{k})$ is the least integer n for which there is a continuous map $f : Z \rightarrow X$ from an n -cone Z such that $H^*(f; \mathbb{k})$ is injective. (This invariant was introduced in a slightly different form by Toomer in [149].)

Proposition 27.14 *If X is a path connected normal space then for any coefficient ring \mathbb{k} ,*

$$c(X; \mathbb{k}) \leq e(X; \mathbb{k}) \leq \text{cat } X \leq \text{cl } X .$$

proof: To show $c(X; \mathbb{k}) \leq e(X; \mathbb{k})$ it is enough to show that $c(Z; \mathbb{k}) \leq n$ for n -cones Z . Write $Z = Y \cup_h \overline{CA}$ for some $(n - 1)$ cone Y , choose classes $\alpha_0, \dots, \alpha_n \in H^+(Z; \mathbb{k})$ and let $\beta = \alpha_0 \cup \dots \cup \alpha_{n-1}$. Recall (§5) that the inclusion $C^*(Z, Y; \mathbb{k}) \rightarrow C^*(Z; \mathbb{k})$ induces a morphism $\lambda : H^*(Z, Y; \mathbb{k}) \rightarrow H^*(Z; \mathbb{k})$ of $H^*(Z; \mathbb{k})$ -modules. Now by induction β restricts to zero in $H^*(Y; \mathbb{k})$ and so $\beta = \lambda\beta'$, some $\beta' \in H^*(Z, Y; \mathbb{k})$. Hence $\beta \cup \alpha_n = \lambda(\beta' \cup \alpha_n)$.

On the other hand, by excision the obvious map $(\varphi, h) : (CA, A) \rightarrow (Z, Y)$ induces an isomorphism $H^*(\varphi, h) : H^*(Z, Y; \mathbb{k}) \xrightarrow{\cong} H^*(CA, A; \mathbb{k})$. Moreover $H^*(\varphi, h)(\beta' \cup \alpha_n) = H^*(\varphi, h)\beta' \cup H^*(\varphi)\alpha_n = 0$, because \overline{CA} is contractible. Thus $\beta' \cup \alpha_n = 0$ and hence so is $\beta \cup \alpha_n = \lambda(\beta' \cup \alpha_n)$. This proves that $c(Z; \mathbb{k}) \leq n$.

The remaining inequalities are trivial consequences of Theorem 27.10 (where, indeed, the third inequality is stated). □

Next recall the Ganea fibrations $p_n : P_n X \rightarrow X$ introduced in §27(c).

Proposition 27.15 *If (X, x_0) is well-based and normal then $e(X; \mathbb{k})$ is the least integer m (or ∞) such that $H^*(p_m; \mathbb{k})$ is injective.*

proof: Clearly $e(X; \mathbb{k})$ is less than or equal to this least integer, because $P_n X$ has the homotopy type of an n -cone (Proposition 27.9). On the other hand, if $e(X; \mathbb{k}) = m$ choose a map $f : Z \rightarrow X$ from an m -cone such that $H^*(f; \mathbb{k})$ is injective. We can suppose f is a based map because Z is well-based. (Replace f by a homotopic map if necessary.)

Recall (§27(c)) that f induces continuous maps $P_m f : P_m Z \rightarrow P_m X$ such that $p_m^X \circ P_m f = f \circ p_m^Z$. Moreover, since Z is an m -cone $\text{cat } Z \leq m$ (Theorem 27.10) and so there is a continuous map $\sigma : Z \rightarrow P_m Z$ such that $p_m^Z \circ \sigma = id_Z$. Then $f = f \circ p_m^Z \circ \sigma = p_m^X \circ P_m f \circ \sigma$. Since $H^*(f; \mathbb{k})$ is injective so is $H^*(p_m^X; \mathbb{k})$. □

Next, consider a continuous map

$$f : (Y, y_0) \rightarrow (X, x_0)$$

between topological spaces, and recall that it induces maps

$$\begin{array}{ccc} P_n Y & \xrightarrow{P_n f} & P_n X \\ p_n^Y \downarrow & & \downarrow p_n^X \\ Y & \xrightarrow{f} & X \end{array}$$

between the Ganea fibrations. If $H^*(f; \mathbb{k})$ is an isomorphism then clearly $c(Y; \mathbb{k}) = c(X; \mathbb{k})$. However, we also have

Proposition 27.16 *Suppose X and Y are normal and simply connected, and let $\mathbb{k} \subset \mathbb{Q}$. If $H^*(f; \mathbb{k})$ is an isomorphism then $e(Y; \mathbb{k}) = e(X; \mathbb{k})$.*

Remark There can be no analogue of Proposition 27.16 for LS category. Indeed, the inclusion of the base point, x_0 , in the space X below is a weak homotopy equivalence:

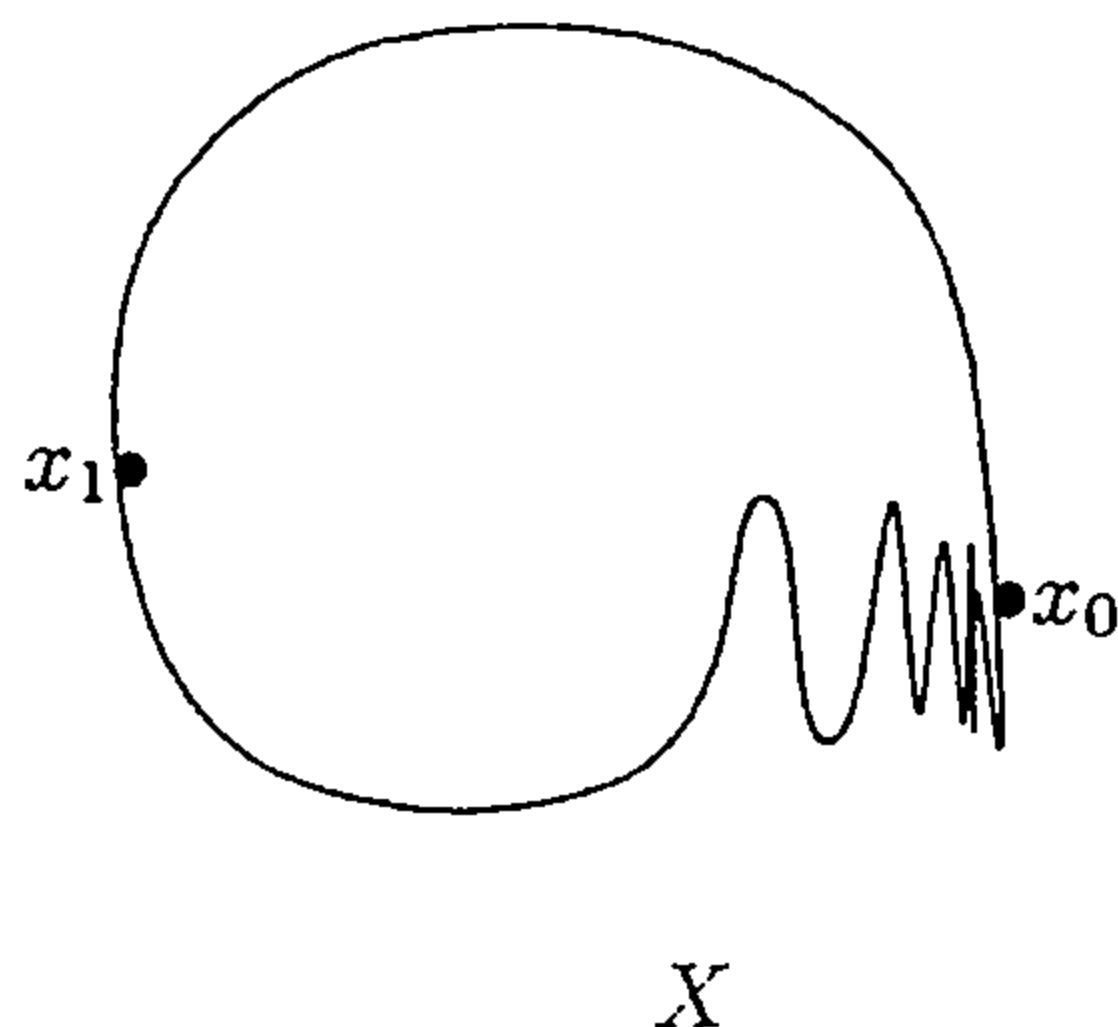

However, no neighbourhood of x_0 is contractible in X and so $\text{cat } X = \infty!$

The main step in the proof of Proposition 27.16 is

Lemma 27.17 *Suppose $\mathbb{k} \subset \mathbb{Q}$ and $H_*(f; \mathbb{k})$ is an isomorphism. Then $H_*(P_m f; \mathbb{k})$ is an isomorphism for $m \geq 1$. In particular if f is a weak homotopy equivalence so is each $P_m f$.*

proof: Suppose first that if $h_A : A' \rightarrow A$ and $h_B : B' \rightarrow B$ are continuous maps between path connected spaces, and that $H_*(h_A; \mathbb{k})$ and $H_*(h_B; \mathbb{k})$ are isomorphisms. Then the natural homeomorphism $(CA \times B) \times_{A \times B} (A \times CB) \cong A * B$ of §1(f) implies that $H_*(h_A * h_B; \mathbb{k})$ is an isomorphism.

Let $F_m f : F_m Y \rightarrow F_m X$ denote the restriction of $P_m f$ to the fibres. Proposition 27.6 provides homotopy equivalences $F_m(-) \simeq F_{m-1}(-) * \Omega(-)$ which, with a little care, can be chosen to identify $F_m f$ with $F_{m-1} f * \Omega f$ up to homotopy. The Whitehead-Serre theorem 8.6 asserts that $H_*(\Omega f; \mathbb{k})$ is an isomorphism. Hence so is each $H_*(F_m f; \mathbb{k})$.

A simple van Kampen argument shows that the join of path connected spaces is simply connected. In particular, it follows from Theorem 8.6 that each $\pi_*(F_m f) \otimes \mathbb{k}$, $m \geq 1$, is an isomorphism. Hence $P_m X$ is simply connected, $m \geq 1$ and $\pi_*(P_m f) \otimes \mathbb{k}$ is an isomorphism (long exact homotopy sequence). A second application of Theorem 8.6 gives that $H_*(P_m f; \mathbb{k})$ is an isomorphism. The final assertion of the lemma follows immediately from the same theorem. \square

proof of Proposition 27.16: If $g : W \rightarrow Z$ is a continuous map and if $H_*(g; \mathbb{k})$ is an isomorphism then $C_*(g; \mathbb{k})$ is a chain equivalence (i.e., has a chain inverse) and so $C^*(g; \mathbb{k})$ is a quasi-isomorphism too. In particular, $H^*(f; \mathbb{k})$ and $H^*(P_m f; \mathbb{k})$ are isomorphisms. Now use the construction $X \cup_x [0, 1]$ to reduce to the case f is a based map between well-based spaces. Then apply Proposition 27.15. \square

Exercises

1. Let X and Z be based path connected spaces, and suppose $\text{cat } Z \leq m$. Prove that every continuous map $f : Z \rightarrow X$ factors up to homotopy through $P_m(X)$.

2. Let X be a simply connected CW complex and $Y = X \cup_{\varphi} e^n$. Suppose that $\text{cat } X = m$ and $n < 2m$. Prove that $\text{cat } Y \leq \text{cat } X$.
3. Prove that $P_1(X) \cong \Sigma\Omega X$.
4. A *co-H-space* is a space X together with a continuous map $\nabla : X \rightarrow X \vee X$ such that $(id_X \vee *) \circ \nabla \sim id_X$ and $(* \vee id_X) \circ \nabla \sim id_X$. Prove that a based CW complex X is a co-H-space if and only if $\text{cat } X \leq 1$.
5. Let X be a finite CW complex. Prove that $\text{cat}_0 X = \text{cat } X_P$, where P is the complement of a finite set in the set of all prime numbers (cf. §9-exercise 5).

28 Rational LS category and rational cone-length

In this section the ground ring is \mathbb{Q} .

We begin by recalling some basic facts from §8 and §1 that will be used without further reference; then we introduce cat_0 , cl_0 and e_0 as (geometric) invariants and finally outline the main results of the section, which treats rational category from a geometric perspective.

Firstly, if f is a continuous map between simply connected topological spaces then $H_*(f; \mathbb{Q})$ is an isomorphism if and only if $\pi_*(f) \otimes \mathbb{Q}$ is an isomorphism (Theorem 8.6). In this case f is a *rational homotopy equivalence*. Two spaces X and Y have the *same rational homotopy type* if they are connected by a chain of rational homotopy equivalences in alternating directions (Proposition 9.8), in which case we write $X \simeq_{\mathbb{Q}} Y$.

A simply connected space is *rational* if its homotopy groups (or, equivalently, its integral homology groups) are rational vector spaces. For each simply connected space X there is a relative CW complex $(X_{\mathbb{Q}}, X)$, unique up to homotopy type rel X such that $X_{\mathbb{Q}}$ is a rational space and $X \rightarrow X_{\mathbb{Q}}$ is a rational homotopy equivalence (§9(b)). We call such an $X_{\mathbb{Q}}$ a *rationalization* of X . If X is a CW complex then so is $X_{\mathbb{Q}}$. Finally if $g : X \rightarrow Y$ is any continuous map into a simply connected rational space Y then g extends (uniquely up to homotopy rel X) to a map $g_{\mathbb{Q}} : X_{\mathbb{Q}} \rightarrow Y$ (Theorem 9.7).

Definition Let X be a simply connected topological space.

- 1 The *rational LS category*, $\text{cat}_0 X$, is the least integer m such that $X \simeq_{\mathbb{Q}} Y$ and $\text{cat} Y = m$.
- 2 The *rational cone-length*, $\text{cl}_0 X$, is the least integer n such that $X \simeq_{\mathbb{Q}} Y$ and $\text{cl}(Y) = n$.
- 3 The *rational Toomer invariant*, $e_0 X$, is the least integer r such that $X \simeq_{\mathbb{Q}} Y$ and $e(Y; \mathbb{Q}) = r$.
- 4 The *rational cup length*, $c_0 X$, is the cup length of $H^*(X; \mathbb{Q})$.

Note that, by definition, these are invariants of rational homotopy type.

Among the main results of this section we establish

- For simply connected CW complexes X , $\text{cat}_0 X = \text{cat} X_{\mathbb{Q}}$, $\text{cl}_0 X = \text{cl}(X_{\mathbb{Q}})$ and $e_0 X = e(X; \mathbb{Q})$.
- For any simply connected space X ,

$$e_0 X \leq \text{cat}_0 X \leq \text{cl}_0 X \leq \text{cat}_0 X + 1 .$$

- (*Mapping Theorem*) If a continuous map $f : X \rightarrow Y$ between simply connected spaces satisfies: $\pi_*(f) \otimes \mathbb{Q}$ is injective, then $\text{cat}_0 X \leq \text{cat}_0 Y$.

This section is organized into the following topics:

- (a) Rational LS category.

- (b) Rational cone-length.
- (c) The mapping theorem.
- (d) Gottlieb groups.

(a) Rational LS category.

Here we prove

Proposition 28.1 *If X is a simply connected CW complex, then*

- (i) $\text{cat}_0 X = \text{cat } X_{\mathbb{Q}}$.
- (ii) $e_0 X = e(X; \mathbb{Q}) = e(X_{\mathbb{Q}}; \mathbb{Q})$.

First we need

Lemma 28.2 *Let X be a simply connected CW complex.*

- (i) *If $f : X \rightarrow Y$ is a weak homotopy equivalence then $\text{cat } X \leq \text{cat } Y$.*
- (ii) $\text{cat } X_{\mathbb{Q}} \leq \text{cat } X$.

proof: (i) Put $\text{cat } Y = m$. Then $\text{cat } f \leq m$ (Lemma 27.1). Hence f factors as $p_m^Y \circ \sigma$ for some continuous $\sigma : X \rightarrow P_m Y$ (Proposition 27.8). Since $P_m f : P_m X \rightarrow P_m Y$ is also a weak homotopy equivalence (Lemma 27.17) we may lift σ through $P_m f$ to construct a continuous $\tau : X \rightarrow P_m X$ such that $P_m f \circ \tau \sim \sigma$. Then $f \circ p_m^X \circ \tau \sim f$ and so $p_m^X \circ \tau \sim id_X$ (Lemma 1.4). It follows (Proposition 27.8) that $\text{cat } X \leq m$.

(ii) If $\text{cat } X = m$ then there is a map $\sigma : X \rightarrow P_m X$ such that $p_m^X \circ \sigma = id$ (Proposition 27.8). This extends to $\sigma_{\mathbb{Q}} : X_{\mathbb{Q}} \rightarrow (P_m X)_{\mathbb{Q}}$, and $(p_m^X)_{\mathbb{Q}} \circ \sigma_{\mathbb{Q}} \sim id$.

On the other hand, let $j : X \rightarrow X_{\mathbb{Q}}$ be the inclusion. A simple calculation (using $F_m \simeq \Sigma^m(\Omega X)^{\wedge m+1}$ of Step 2 in Proposition 27.9) shows that $P_m(X_{\mathbb{Q}})$ is a rational space. Hence $P_m(j)$ extends to a continuous map $P_m(j)_{\mathbb{Q}} : P_m(X)_{\mathbb{Q}} \rightarrow P_m(X_{\mathbb{Q}})$, and $p_m^{X_{\mathbb{Q}}} \circ P_m(j)_{\mathbb{Q}} \sim (p_m^X)_{\mathbb{Q}}$. Since $X_{\mathbb{Q}}$ is a CW complex it follows that $p_m^{X_{\mathbb{Q}}} \circ \sigma_{\mathbb{Q}} \sim id$ and $\text{cat } X_{\mathbb{Q}} \leq m$ (Proposition 27.8). □

proof of Proposition 28.1: Suppose $X \simeq_{\mathbb{Q}} Y$. Choose a weak homotopy equivalence $Z \rightarrow Y$ from a CW complex Z . Then $X_{\mathbb{Q}}$ and $Z_{\mathbb{Q}}$ have the same weak homotopy type. But these are CW complexes and so they have the same homotopy type. Hence $\text{cat } X_{\mathbb{Q}} = \text{cat } Z_{\mathbb{Q}} \leq \text{cat } Z \leq \text{cat } Y$.

On the other hand, Proposition 27.14 states that $e(Y; \mathbb{Q}) = e(Z; \mathbb{Q})$ and Proposition 27.15 identifies this as the least integer m such that $H^*(p_m^Z; \mathbb{Q})$ is injective. Rationalizing $P_m Z$ and Z , we can replace p_m^Z with $(p_m^Z)_{\mathbb{Q}}$. But it follows from

the proof of Lemma 28.2(ii) that if $H^* \left((p_m^Z)_Q; \mathbb{Q} \right)$ is injective so is $H^* \left(p_m^Z; \mathbb{Q} \right)$. Thus $e(X_Q; \mathbb{Q}) = e(Z_Q; \mathbb{Q}) \leq e(Z; \mathbb{Q}) = e(Y; \mathbb{Q})$. \square

Example 1 $\text{cat}_0 \left(\bigvee_{\alpha} X_{\alpha} \right) = \max_{\alpha} \{ \text{cat}_0 X_{\alpha} \}$.

Here the X_{α} are taken simply connected. We may suppose the X_{α} are rational CW complexes and then the equality follows from Proposition 28.1 and the analogous equality for cat (introduction to §27). \square

(b) Rational cone-length.

As a special case of the n -cones defined in §27(d) we define *spherical n -cones* to be based spaces (P, p_0) presented as $\{p_0\} = P_0 \subset P_1 \subset \dots \subset P_n$ with each $P_{k+1} = P_k \cup_{h_k} \overline{C}S_k$, where S_k has the form

$$S_k = \bigvee_{\alpha \in \mathcal{J}_k} S^{r_{\alpha} + k + 1}, \quad r_{\alpha} \geq 0.$$

(In particular any composite of $n + 1$ Steenrod operations vanishes in a spherical n -cone. Thus, although $\Sigma\mathbb{C}P^{\infty}$ is a 1-cone, it is not a spherical n -cone for any n .) Notice that each P_k in a spherical n -cone is *automatically simply connected*.

Proposition 28.3

- (i) If X is simply connected then $\text{cl}_0 X$ is the least integer n such that there is a rational homotopy equivalence $f : P \rightarrow X$ from a spherical n -cone, P .
- (ii) If X is a simply connected CW complex then $\text{cl}_0 X = \text{cl}(X_Q)$.

Lemma 28.4 If $\rho : X \rightarrow Q$ is a rational homotopy equivalence to a simply connected r -cone, Q , then there is a rational homotopy equivalence $f : P \rightarrow X$ from a spherical r -cone, P .

proof: Write $Q = Q_r \supset \dots \supset Q_0 = \{q_0\}$ with $Q_{k+1} = Q_k \cup_{g_k} \overline{C}\Sigma^k Y_k$ as in §27(d).

Sublemma We may suppose each Q_k is simply connected.

proof of sublemma: It is sufficient (van Kampen) that Y_0 be path connected. Now Q_1 is simply connected because Q is, and so $H_1(Q_1; \mathbb{Z}) = 0$ (Theorem 4.19). It follows that $H_1(g_1) : H_1(\Sigma Y_1; \mathbb{Z}) \rightarrow H_1(\Sigma Y_0; \mathbb{Z})$ is surjective, since this may be identified with the connecting homomorphism $H_2(Q_1, Q_0; \mathbb{Z}) \rightarrow H_1(Q_0; \mathbb{Z})$.

Next, recall that Y_0 and Y_1 are well-based with base-points y_0 and y_1 . Let $y_{0\alpha}$ and $y_{1\beta}$ be base-points for the other path components of Y_0 and Y_1 . Then the interval through $y_{0\alpha}$ becomes a circle in ΣY_0 representing a homology class v_{α} , and $H_1(\Sigma Y_0; \mathbb{Z}) = \bigoplus_{\alpha} \mathbb{Z}v_{\alpha}$, again by van Kampen and Theorem 4.19. Similarly

$H_1(\Sigma Y_1; \mathbb{Z}) = \bigoplus_{\beta} \mathbb{Z}w_{\beta}$ where w_{β} is represented by the interval through $y_{1\beta}$. In particular, we may choose a subset \mathcal{J} of path components of Y_1 such that

$$H_1(g_1) : \bigoplus_{\beta \in \mathcal{J}} \mathbb{Q} \cdot w_{\beta} \xrightarrow{\cong} H_1(\Sigma Y_0; \mathbb{Q}) .$$

Now for each $y_{0\alpha}$ adjoin an interval I_{α} to Y_0 by attaching $\{0\}$ to y_0 and $\{1\}$ to $y_{0\alpha}$. This gives $\hat{Y}_0 = Y \cup \left(\coprod_{\alpha} I_{\alpha} \right)$. Similarly, construct $\hat{Y}_1 = Y_1 \cup \left(\coprod_{\beta \in \mathcal{J}} I_{\beta} \right)$. Then \hat{Y}_0 is path connected, so $\Sigma \hat{Y}_0$ is simply connected and g_1 extends to a continuous map $\hat{g}_1 : \Sigma \hat{Y}_1 \rightarrow \Sigma \hat{Y}_0$. Set $\hat{Q} = \Sigma \hat{Y}_0 \cup_{\hat{g}_1} \overline{C} \Sigma \hat{Y}_1 \cup \overline{C} \Sigma^2 Y_2 \cup \dots \cup \overline{C} \Sigma^{r-1} Y_{r-1}$. Then \hat{Q} is simply connected and a straight forward calculation shows that the inclusion $Q \rightarrow \hat{Q}$ induces an isomorphism of rational homology. Thus we may replace Q by \hat{Q} ; i.e., we may assume Y_0 is path connected, and each Q_k is simply connected. \square

We now return to the proof of the lemma. Observe that it is sufficient to consider the case that ρ is a fibration. Set $X_k = \rho^{-1}(Q_k)$. Since $\pi_*(\rho) \otimes \mathbb{Q}$ is an isomorphism the fibre, F , of ρ satisfies $\pi_*(F) \otimes \mathbb{Q} = 0$. Hence the restrictions $\rho_k : X_k \rightarrow Q_k$ satisfy $\pi_*(\rho_k) \otimes \mathbb{Q}$ is an isomorphism.

Suppose by induction on k that there is a continuous map $g : Z \rightarrow X_k$ with Z homotopy equivalent to a spherical k -cone, P_k and $\pi_*(g) \otimes \mathbb{Q}$ an isomorphism. Again we may take g to be a fibration. Theorem 24.5 provides a rational homotopy equivalence $h : S_k \rightarrow \Sigma^k Y_k$ with $S_k = \bigvee_{\alpha \in \mathcal{J}_k} S^{k+1+r_{\alpha}}$. Let $h_{\alpha} = h \Big|_{S^{k+1+r_{\alpha}}}$.

Then the map $\overline{C} S^{k+1+r_{\alpha}} \xrightarrow{\overline{C} h_{\alpha}} \overline{C} \Sigma^k Y_k \rightarrow Q_{k+1}$ lifts through ρ_{k+1} to a based map $H_{\alpha} : \overline{C} S^{k+1+r_{\alpha}} \rightarrow X_{k+1}$, and this restricts to a map $\theta_{\alpha} : S^{k+1+r_{\alpha}} \rightarrow X_k$.

Since $\pi_*(g) \otimes \mathbb{Q}$ is an isomorphism, there is a positive integer m_{α} with $m_{\alpha}[\theta_{\alpha}] \in \text{Im } \pi_*(g)$. Moreover, without loss of generality we may suppose $m_{\alpha} = 1$. (Simply replace h by a new map h' so that $[h'_{\alpha}] = m_{\alpha}[h_{\alpha}]$; then relabel h' as h .) Then, since g is a fibration, θ_{α} lifts to a based map $\sigma_{\alpha} : S^{k+1+r_{\alpha}} \rightarrow Z$, and we may construct

$$\hat{g} = (g, \{H_{\alpha}\}) : Z \cup_{\{\sigma_{\alpha}\}} \overline{C} \bigvee_{\alpha} S^{k+1+r_{\alpha}} \rightarrow X_{k+1} .$$

Since $\pi_*(\rho_k g) \otimes \mathbb{Q}$ is an isomorphism so is $H_*(\rho_k g; \mathbb{Q})$. Now an easy homology calculation shows that the composite of \hat{g} with ρ_{k+1} is a rational homotopy equivalence. Hence $\pi_*(\hat{g}) \otimes \mathbb{Q}$ is an isomorphism, and the lemma follows by induction. \square

proof of Proposition 28.3: (i) Given a rational homotopy equivalence $f : P \rightarrow X$ from a spherical n -cone we have $\text{cl}_0(X) \leq \text{cl}(P) \leq n$. Conversely, suppose $\text{cl}_0(X) = n$. Then there is a chain of rational homotopy equivalences

$$X \rightarrow \dots \leftarrow Q$$

with Q an n -cone. Apply Lemma 28.4 a finite number of times to obtain a rational homotopy equivalence $f : P \rightarrow X$ with P a spherical n -cone.

(ii) By definition $\text{cl}_0 X \leq \text{cl}(X_{\mathbb{Q}})$. Moreover, if $Y \simeq_{\mathbb{Q}} X$ and $\text{cl}(Y) = n$ then (Lemma 28.4) there is a rational homotopy equivalence $P \rightarrow Y$ from a spherical n -cone. Present P as $\{p_0\} \subset \cdots \subset P_n = P$ with $P_{k+1} = P_k \cup \overline{C}\Sigma^k Y_k$, where Y_k is a wedge of spheres. Then there is an obvious weak homotopy equivalence

$$\{p_0\} \cup \overline{C}\Sigma(Y_1)_{\mathbb{Q}} \cup \cdots \cup \overline{C}\Sigma^{n-1}(Y_{n-1})_{\mathbb{Q}} \rightarrow P_{\mathbb{Q}}.$$

Denote the n -cone on the left by P' . Since each (P'_{k+1}, P'_k) is a relative CW complex and since $P_{\mathbb{Q}} \rightarrow X_{\mathbb{Q}}$ is a weak homotopy equivalence a direct application of Lemma 1.4 shows that $P' \rightarrow X_{\mathbb{Q}}$ is a homotopy equivalence. Thus $\text{cl}(X_{\mathbb{Q}}) \leq n$. It follows that $\text{cl}(X_{\mathbb{Q}}) \leq \text{cl}(Y)$ for all $Y \simeq_{\mathbb{Q}} X$; i.e. $\text{cl}(X_{\mathbb{Q}}) = \text{cl}_0 X$. \square

Theorem 28.5 *If X is a simply connected topological space then*

- (i) $e_0 X \leq \text{cat}_0 X \leq \text{cl}_0 X \leq \text{cat}_0 X + 1$.
- (ii) *If $e_0 X = 1$ then $e_0 X = \text{cat}_0 X = \text{cl}_0 X = 1$ and X has the rational homotopy type of a wedge of spheres.*
- (iii) *If X is a CW complex then $\text{cat}_0 X \leq m$ if and only if $X_{\mathbb{Q}}$ is a homotopy retract of an m -cone.*

proof: (i) Since the invariants are invariants of rational homotopy type we may suppose X is a CW complex, so that $e_0 X = e(X_{\mathbb{Q}}; \mathbb{Q})$, $\text{cat}_0 X = \text{cat } X_{\mathbb{Q}}$ and $\text{cl}_0 X = \text{cl}(X_{\mathbb{Q}})$. (Proposition 28.1 and 28.3). Now the first two inequalities of (i) follow from Proposition 27.14.

For the last inequality and the proof of (iii), let $\text{cat}_0 X = m$. We lose no generality in supposing X a rational CW complex. Then $X \simeq X_{\mathbb{Q}}$ and $\text{cat } X = m$ (Proposition 28.1). Thus the m^{th} Ganea fibration $p_m : P_m X \rightarrow X$ admits a cross-section σ (Corollary to Proposition 27.8).

Convert σ to a fibration $E \rightarrow P_m X$ with fibre F , and $E \simeq X$. In the proof of Theorem 27.11 we showed that

$$E \cup CF \simeq X \vee \Sigma Y,$$

where Y is a well-pointed space homotopy equivalent to F . Hence $X \simeq (E \cup CF) \cup \overline{C}\Sigma Y$.

On the other hand, we also showed in the proof of 27.11 that $\pi_*(F) \cong \pi_{*+1}(F_m)$, F_m the fibre of p_m . But $F_m \simeq \Sigma^m(\Omega X^{\wedge m+1})$ by Step 2 in the proof of Proposition 27.9. Since the smash of path connected well-based spaces is simply connected (trivial) it follows that F and Y are m -connected. Finally, Proposition 27.9 identifies $P_m X$ as homotopy equivalent to an m -cone and so $E \cup CF$ also has this property (Proposition 27.13). Since $X \simeq (E \cup CF) \cup \overline{C}\Sigma Y$, it follows that $\text{cl}_0 X \leq \text{cl } X \leq m + 1$.

Note that we have identified X as a retract of $P_m X$ which is homotopy equivalent to an m -cone.

Finally to prove (ii) suppose $e_0 X = 1$. Then the first Ganea fibration, $\Sigma\Omega X \rightarrow X$, is surjective in rational homology. Since there is a rational homotopy equivalence from a wedge of spheres to $\Sigma\Omega X$ (Theorem 24.5) the rational Hurewicz homomorphism for X is surjective and X itself has the rational homotopy type of a wedge of spheres (Theorem 24.5). \square

Remark As observed in §27, Theorem 28.5(i) is a special case of a theorem of Cornea.

(c) The mapping theorem.

The usefulness of rational LS category in rational homotopy theory is in large part due to

Theorem 28.6 (Mapping theorem) *Let $f : X \rightarrow Y$ be a continuous map between simply connected topological spaces. If $\pi_*(f) \otimes \mathbb{Q}$ is injective then*

$$\text{cat}_0 X \leq \text{cat}_0 Y .$$

proof: We lose no generality in assuming X and Y are rational CW complexes. Let $\text{cat}_0 Y = m$ and convert f to the fibration $g : E = X \times_Y MY \rightarrow Y$ as described in §2(c). Then inclusion of the fibre $X \times_Y PY$ induces zero in homotopy, because $\pi_*(g)$ is injective. The homotopy equivalence $E \rightarrow X$ converts this inclusion to a fibration $p : X \times_Y PY \rightarrow X$ and so $\pi_*(p) = 0$ and the fibre inclusion $j : \Omega Y \rightarrow X \times_Y PY$ satisfies: $\pi_*(j)$ is surjective.

Decompose the rational vector spaces $\pi_n(\Omega Y)$ as $\pi'_n \oplus \pi''_n$, with $\pi_*(j) : \pi'_n \xrightarrow{\cong} \pi_n(X \times_Y PY)$. Let K'_n and K''_n be cellular Eilenberg-MacLane spaces of types (π'_n, n) and (π''_n, n) , respectively. Apply the Corollary to Proposition 16.7 to obtain a weak homotopy equivalence

$$\varphi : \prod_n^{\sim} K'_n \times \prod_n^{\sim} K''_n \rightarrow \Omega Y .$$

Then setting $K' = \prod_n^{\sim} K'_n$ we see that $j\varphi : K' \rightarrow X \times_Y PY$ is a weak homotopy equivalence.

Now let $\lambda : X \times_Y PY \rightarrow E$ be the inclusion and set

$$\psi = (id, Cj\varphi) : E \cup_{\lambda j\varphi} CK' \rightarrow E \cup_{\lambda} C(X \times_Y PY) .$$

By Proposition 27.13, $\text{cat}(E \cup C(X \times_Y PY)) \leq m$. Moreover, since λj is the constant map, $E \cup_{\lambda j\varphi} CK' = E \vee (CK'/K')$, and this space is simply connected. Thus ψ is a weak homotopy equivalence, by an obvious homology calculation.

Since $E \vee (CK'/K')$ has the homotopy type of a CW complex we conclude from Lemma 28.2 that

$$\begin{aligned} \text{cat}_0 X \leq \text{cat } X &\leq \text{cat}(E \vee (CK'/K')) \\ &\leq \text{cat}(E \cup_\lambda C(X \times_Y PY)) \leq m . \end{aligned}$$

□

Corollary *If f is as in Theorem 28.1 and X is a CW complex then $\text{cat } f_{\mathbb{Q}} = \text{cat}_0 X$.*

proof: Let $\text{cat } f_{\mathbb{Q}} = m$ and let $p_m : P_m \rightarrow Y_{\mathbb{Q}}$ be the m^{th} Ganea fibration for $Y_{\mathbb{Q}}$. Then $f_{\mathbb{Q}} = p_m \sigma$ for some continuous map $\sigma : X_{\mathbb{Q}} \rightarrow P_m$ (Proposition 27.8). In particular, $\pi_*(\sigma) \otimes \mathbb{Q}$ is injective and so

$$m \geq \text{cat}_0 P_m \geq \text{cat}_0 X_{\mathbb{Q}} = \text{cat } X_{\mathbb{Q}}$$

(Proposition 28.1). But also $m = \text{cat } f_{\mathbb{Q}} \leq \text{cat } X_{\mathbb{Q}}$ by Lemma 27.1. □

Example 1 *Postnikov fibres.*

Let X be a simply connected CW complex and suppose $\pi_i(X) = 0$, $i < r$. From Proposition 4.20 we obtain a fibration $X \xrightarrow{p} K(\pi_r(X), r)$ such that $\pi_r(p)$ is the identity. If Z is a CW complex mapping by a weak homotopy equivalence to the fibre of p then the composite $Z \xrightarrow{f} X$ satisfies: $\pi_i(f)$ is an isomorphism for $i \geq r + 1$. In this way we obtain a sequence of maps

$$\rightarrow X^{n+1} \xrightarrow{g_n} \dots \rightarrow X^3 \xrightarrow{g_2} X^2 = X$$

such that X^{n+1} is an n -connected CW complex and $\pi_i(g_n)$ is an isomorphism for $i \geq n + 1$. The X^n are called *Postnikov fibres* of X .

Notice that we can apply the Mapping theorem to this sequence to obtain

$$\dots \leq \text{cat}_0 X^n \leq \dots \leq \text{cat}_0 X^2 \leq \text{cat}_0 X .$$

In particular, if X has finite rational LS category, so do all its Postnikov fibres. □

Example 2 *Free loop spaces have infinite rational category.*

Let X be a topological space. The *free loop space* of X is the space X^{S^1} of all continuous maps $S^1 \rightarrow X$ (§0). We show that

- *If X is two-connected and if $H_+(X; \mathbb{Q}) \neq 0$ then*

$$\text{cat}_0(X^{S^1}) = \infty .$$

(Better results can be proved with a little more work.)

Indeed, let $e \in S^1$ be a basepoint. Evaluation at e defines a fibration $p : X^{S^1} \rightarrow X$ whose fibre at a basepoint $x_0 \in X$ is the loop space ΩX . The map $s : X \rightarrow X^{S^1}$ which associates to x the constant loop $S^1 \rightarrow x$ is a cross-section for p , and it follows that the inclusions $j : \Omega X \rightarrow X^{S^1}$ and $s : X \rightarrow X^{S^1}$ are injective in homotopy.

Suppose $\text{cat}_0(X^{S^1}) = m < \infty$. Since X is 2-connected, ΩX and X^{S^1} are simply connected. Thus Theorem 28.6 asserts that if $\text{cat}_0(X^{S^1}) = m < \infty$, $\text{cat}_0 X \leq m$ and $\text{cat}_0 \Omega X \leq m$. Suppose $f_i : S^{2n_i+1} \rightarrow X$ and $g_j : S^{2m_j} \rightarrow X$ represent linearly independent elements in $\pi_*(X) \otimes \mathbb{Q}$. Then, as in Proposition 16.7, $\prod_i \Omega f_i \times \prod_j \hat{g}_j : \prod_i \Omega S^{2n_i+1} \times \prod_j S^{2m_j} \rightarrow \Omega X$ is injective in rational homotopy, and so the category of this product is bounded by m . Since $H^*(\Omega S^{2n_i+1}; \mathbb{C})$ is a polynomial algebra (Example 1, §15(b)) it follows that $\pi_{\text{odd}}(X) \otimes \mathbb{Q} = 0$ and $\dim \pi_{\text{even}}(X) \otimes \mathbb{Q}$ is finite. Now X has a Sullivan model of the form ΛV^{even} and so its cohomology is a polynomial algebra, contradicting $\text{cat}_0 X < \infty$. \square

(d) Gottlieb groups.

Recall (Theorem 1.4) that any based topological space (X, x_0) admits a weak homotopy equivalence from a based CW complex (Y, y_0) , called a cellular model for X . In particular an element $\alpha \in \pi_n(X)$ is representable by a unique based homotopy class of continuous maps $f : (S^n, *) \rightarrow (Y, y_0)$.

Definition $\alpha \in \pi_n(X)$ is a *Gottlieb element* for X if $(f, id) : S^n \vee Y \rightarrow Y$ extends to a continuous map $\varphi_f : S^n \times Y \rightarrow Y$. (Note that this condition is independent of the choices of f and of cellular model.)

Remark Gottlieb elements were introduced by Gottlieb in [67]; however, not with this name!

Given a second Gottlieb element $\beta \in \pi_r(X)$ represented by $g : S^r \rightarrow Y$ we note that

$$S^n \times S^r \times Y \xrightarrow{id \times \varphi_g} S^n \times Y \xrightarrow{\varphi_f} Y$$

restricts to (f, g, id_Y) in $S^n \vee S^r \vee Y$. More generally, if f_i represents a Gottlieb element in $\pi_{n_i}(X)$ then $(f_1, \dots, f_k, id_Y) : S^{n_1} \vee \dots \vee S^{n_k} \vee Y \rightarrow Y$ extends to a continuous map

$$S^{n_1} \times \dots \times S^{n_k} \times Y \rightarrow Y .$$

Next observe that the Gottlieb elements form a group. In fact if $f, g : (S^n, *) \rightarrow (Y, y_0)$ then $[f] + [g]$ is represented by $(S^n, *) \xrightarrow{j} (S^n \vee S^n, *) \xrightarrow{(f,g)} (Y, y_0)$ as described in the proof of Lemma 13.6. Since (f, g, id_Y) extends to a map $S^n \times S^n \times Y \rightarrow Y$, $((f, g)j, id_Y)$ extends to $S^n \times Y$. The fact that the inverse of a Gottlieb element is a Gottlieb element is obvious.

Definition The group of Gottlieb elements in $\pi_n(X)$ is called the n^{th} *Gottlieb group of X* and is denoted by $G_n(X)$. (It is an invariant of weak homotopy type.)

If X is simply connected the group $G_n(X_{\mathbb{Q}})$ of Gottlieb elements in $X_{\mathbb{Q}}$ is called the n^{th} *rational Gottlieb group of X* and will be denoted by $G_n^{\mathbb{Q}}(X)$. Note that $G_n^{\mathbb{Q}}(X)$ is a rational subspace of $\pi_n(X) \otimes \mathbb{Q}$ and contains $G_n(X) \otimes \mathbb{Q}$. This containment may be strict (see Exercise 1).

Recall from §21(d) the definition of the rational homotopy Lie algebra $L_X = \pi_*(\Omega X) \otimes \mathbb{Q} = \pi_*(\Omega X_{\mathbb{Q}})$. By definition, the Lie bracket in L_X corresponds up to sign to the Whitehead product in $\pi_*(X) \otimes \mathbb{Q}$ under the isomorphism $(L_X)_* \cong \pi_{*+1}(X) \otimes \mathbb{Q}$.

Proposition 28.7 *If $\alpha \in (L_X)_n$ corresponds to a Gottlieb element in $\pi_{n+1}(X) \otimes \mathbb{Q}$ then*

$$[\alpha, \beta] = 0, \quad \beta \in L_X.$$

proof: Let $\hat{\alpha} \in \pi_{n+1}(X) \otimes \mathbb{Q}$ be the Gottlieb element corresponding to α and let $\hat{\alpha}$ be represented by a map $f : (S^{n+1}, *) \rightarrow (X, *)$. Without loss of generality assume X is a rational CW complex. Then for any $g : (S^k, *) \rightarrow (X, *)$ the map $(f, g) : S^{n+1} \vee S^k \rightarrow X$ extends to a map $S^{n+1} \times S^k \rightarrow X$, which shows that the Whitehead product of $\hat{\alpha} = [f]$ and $[g]$ is zero (§13(d)). \square

Example 1 *G -spaces.*

Suppose a topological monoid G acts on a topological space X with basepoint x_0 . Restricting the action to $\{x_0\} \times G$ defines a continuous map $j : G \rightarrow X$ and, essentially by definition,

$$\text{Im } \pi_n(j) \subset G_n(X).$$

In particular, $\pi_n(G) = G_n(G)$. \square

Example 2 *The holonomy fibration.*

Suppose $f : X \rightarrow Y$ is a continuous map and, as in §1(c) construct the holonomy fibration $X \times_Y PY \rightarrow X$ with fibre ΩY . Since the inclusion $i : \Omega Y \rightarrow X \times_Y PY$ of the fibre extends to an action of ΩY it follows as in Example 1 that

$$\text{Im } \pi_n(i) \subset G_n(X \times_Y PY), \quad n \geq 1.$$

Now suppose f is itself a Serre fibration with fibre inclusion $j : F \rightarrow X$. Then there is a weak homotopy equivalence between $X \times_Y PY$ and F which identifies $\text{Im } \pi_n(i)$ with $\ker \pi_n(j)$. It follows that

$$\ker \pi_n(j) \subset G_n(F), \quad n \geq 1. \quad \square$$

Proposition 28.8 *Suppose X is a simply connected topological space of finite rational LS category. Then*

- (i) $G_*^{\mathbb{Q}}(X)$ is concentrated in odd degrees, and
- (ii) $\dim G_*^{\mathbb{Q}}(X) \leq \text{cat}_0 X$.

proof: (i) We may assume X itself is a simply connected rational CW complex, and hence that $G_*(X) = G_*^{\mathbb{Q}}(X)$. Suppose first that $f : S^{2k} \rightarrow X$ represents a non-zero Gottlieb element, and that X is $(2k - 1)$ -connected. By Theorem 4.19, $H_{2k}(X; \mathbb{Q}) = \pi_{2k}(X) \otimes \mathbb{Q} = \pi_{2k}(X)$. Thus there is a cohomology class $w \in H^{2k}(X; \mathbb{Q})$ such that $H^*(f)w \neq 0$. Extend (f, \dots, f, id_X) to a map $\varphi : S^{2k} \times \dots \times S^{2k} \times X \rightarrow X$ and observe that $H^*(\varphi)w = H^*(f)w \otimes 1 \otimes \dots \otimes 1 + \dots + 1 \otimes \dots \otimes H^*(f)w \otimes 1 + 1 \otimes \dots \otimes 1 \otimes w$. If we have used n -factors S^{2k} then $H^*(\varphi)w^n = (H^*(\varphi)w)^n \neq 0$. It follows that $w^n \neq 0$ for all n and hence $\text{cat}_0 X = \infty$.

Now suppose X is only simply connected, and let $X^{2k} \rightarrow X$ be its $2k^{\text{th}}$ Postnikov fibre. If $f : S^{2k} \rightarrow X$ represents a non-zero element of $G_{2k}(X)$ then we may assume $f : S^{2k} \rightarrow X^{2k}$. Apply the argument of Lemma 1.5 to the diagram

$$\begin{array}{ccc}
 S^{2k} \vee X^{2k} & \xrightarrow{(f, id)} & X^{2k} \\
 \downarrow & \nearrow \dots & \downarrow \\
 S^{2k} \times X & \xrightarrow{\quad} & X
 \end{array}$$

to fill in the dotted arrow making the upper triangle commute. This identifies f as representing a non-zero element of $G_{2k}(X^{2k})$.

But now the Mapping theorem 28.6 gives $\text{cat}_0 X \geq \text{cat}_0 X^{2k} = \infty$.

(ii) Again we may suppose X is a simply connected rational CW complex. Thus $G_*^{\mathbb{Q}}(X) = G_*(X)$. If $\alpha_1, \dots, \alpha_r$ are linearly independent elements of $G_*(X)$ then, as at the start of this topic we can extend representatives $f_i : S^{n_i} \rightarrow X$ to a map

$$\varphi : S^{n_1} \times \dots \times S^{n_r} \times X \rightarrow X.$$

Let g be the restriction of φ to $S^{n_1} \times \dots \times S^{n_r}$. Then by (i) each n_i is odd and so $\pi_*(S^{n_i}) \otimes \mathbb{Q} = \pi_{n_i}(S^{n_i}) \otimes \mathbb{Q} = \mathbb{Q}$ (Example 1, §15(d)). It follows that $\pi_*(\varphi) \otimes \mathbb{Q}$ is injective and so the Mapping theorem 28.6 asserts that $\text{cat}_0 X \geq \text{cat}_0(S^{n_1} \times \dots \times S^{n_r})$. But the rational cup length of $S^{n_1} \times \dots \times S^{n_r}$ is r and so $\text{cat}_0(S^{n_1} \times \dots \times S^{n_r}) \geq r$. Thus $\text{cat}_0 X \geq \dim G_*^{\mathbb{Q}}(X)$. \square

Corollary Suppose $j : F \rightarrow X$ is the fibre inclusion of a Serre fibration $X \rightarrow Y$, and that F is simply connected. If $\text{cat}_0 F < \infty$ then $\ker \pi_*(j) \otimes \mathbb{Q}$ is concentrated in odd degrees and $\dim(\ker \pi_*(j) \otimes \mathbb{Q}) \leq \text{cat}_0 F$.

proof: By Example 2, above, $\ker \pi_*(j) \otimes \mathbb{Q} \subset G_*(F) \otimes \mathbb{Q} \subset G_*^{\mathbb{Q}}(F)$. \square

Example 3 *Loop spaces.*

Suppose ΩY is a simply connected loop space. We show that

$$\text{cat}_0 \Omega Y < \infty \iff H^*(\Omega Y; \mathbb{Q}) = \Lambda V, \text{ with } V = V^{\text{odd}} \text{ and } \dim V < \infty.$$

In fact if $\text{cat}_0 \Omega Y < \infty$ then $\pi_*(\Omega Y) \otimes \mathbb{Q} = G_*(\Omega Y) \otimes \mathbb{Q}$ (Example 1) and hence is finite dimensional and concentrated in odd degrees. Thus $\pi_*(Y) \otimes \mathbb{Q}$ is finite dimensional and §16(b) asserts that ΩY has a Sullivan model of the form $(\Lambda V, 0)$ with $V \cong \pi_*(\Omega Y) \otimes \mathbb{Q}$.

Conversely if $H^*(\Omega Y; \mathbb{Q}) = \Lambda V$ as above then $(\Lambda V, 0)$ is a Sullivan model for ΩY and $\pi_*(\Omega Y) \otimes \mathbb{Q}$ is a finite dimensional vector space concentrated in odd degrees. If $f_i : S^{2n_i+1} \rightarrow \Omega Y$ represent a basis then multiplication in ΩY defines a rational homotopy equivalence $\prod_{i=1}^r S^{2n_i+1} \rightarrow \Omega Y$ and so $\text{cat}_0 \Omega Y = r < \infty$. \square

Exercises

1. Prove that if $\alpha \in G_n X$, then $[\alpha, \beta] = 0$ for any $\beta \in \pi_k X$.
2. Let $X = S^3 \vee (\bigvee_{n \geq 4} S^n) \cup_{n \geq 4} (\bigcup_{n[S^3, S^n]} D^{n+3})$. Prove that $\pi_3(X) = \mathbb{Z}$, $G_3(X) = 0$, and $G_3^{\mathbb{Q}}(X) = \mathbb{Q}$.
3. Let $f : S^n \rightarrow X$ be a continuous map such that $[f] \in G_n(X)$, and $H_n(f; \mathbb{Z})([S^n]) \neq 0$. Prove that X has the same homotopy type as $Y \times S^n$.
4. Let $f : X \rightarrow Y$ be a continuous map, and suppose that $\pi_*(f) \otimes \mathbb{Q}$ is injective. Prove that $\text{cat}_0 f = \text{cat}_0 X$.
5. Let $f : X \rightarrow Y$ be a continuous map such that $H^*(f; \mathbb{Q})$ is injective. Prove that $e_0(X) \geq e_0(Y)$.

29 LS category of Sullivan algebras

In this section the ground ring is an arbitrary field \mathbb{k} of characteristic zero.

Let X be a simply connected topological space with rational homology of finite type. Then the rational homotopy type of X is completely determined by its minimal Sullivan model (§12, §17) or by any Lie model (§24). It is thus not unexpected that we should be able to compute $\text{cl}_0 X$, $\text{cat}_0 X$ and $e_0 X$ directly from these models. Recall also that a *commutative model for X* is any commutative cochain algebra connected to $A_{PL}(X)$ by a chain of quasi-isomorphisms (§10). Thus (A, d) is a commutative model for X if and only if its minimal Sullivan model coincides with that of X .

Now we introduce the following

Definition Suppose $A = A^{\geq 0}$ is a graded algebra with $A^0 = \mathbb{k}$. The *product length of A* , denoted by $\text{nil } A$, is the greatest integer n (or ∞) such that $A^+ \cdots A^+ \neq 0$ (n factors).

Then we prove (§29(a)) a result of Cornea's [40]:

- $\text{cl}_0 X \leq n \iff \text{nil } A \leq n$ for some rational commutative model (A, d) of X .

Note that $H(A, d) \cong H^*(X; \mathbb{Q})$ and so the product length of $H(A)$ is just the cup length $c(X; \mathbb{Q})$ as defined in §27(f). Thus $\text{cl}_0 X = n$ corresponds to product length n in a suitable cochain algebra model, while $c(X; \mathbb{Q}) = n$ corresponds to product length n in the cohomology algebra.

Next, suppose $(\Lambda V, d)$ is any Sullivan algebra (§12), and $m \geq 1$. Recall that $(\Lambda V, d)$ is filtered by ideals $(\Lambda^{> m} V, d)$ of elements of word length $> m$. The surjections $\varrho_m : (\Lambda V, d) \rightarrow (\Lambda V / \Lambda^{> m} V, d)$ extend to relative Sullivan models of the form

$$\begin{array}{ccc}
 (\Lambda V, d) & \xrightarrow{\lambda_m} & (\Lambda V \otimes \Lambda Z(m), d) \\
 & \searrow \varrho_m & \downarrow \simeq \zeta_m \\
 & & (\Lambda V / \Lambda^{> m} V, d),
 \end{array}$$

as described in §14(a).

Definition The *LS category*, $\text{cat}(\Lambda V, d)$, is the least integer m (or ∞) such that there is a cochain algebra morphism $\pi_m : (\Lambda V \otimes \Lambda Z(m), d) \rightarrow (\Lambda V, d)$ such that $\pi_m \lambda_m = \text{id}_{\Lambda V}$.

The *Toomer invariant*, $e(\Lambda V, d)$, is the least integer r (or ∞) such that $H(\varrho_r)$ is injective.

In §29(b) we then establish

- If $(\Lambda V, d)$ is a rational Sullivan model for X then

$$\text{cat}_0 X = \text{cat}(\Lambda V, d) \quad \text{and} \quad e_0 X = e(\Lambda V, d) .$$

We shall deduce this as a corollary of Cornea’s theorem, although the result itself is older (with a different proof). Then we shall use this to give easy examples in which $e_0 X < \text{cat}_0 X$. Notice that these results indicate a close relation between the topological filtration $P_0 X \subset \dots \subset P_m X \subset \dots$ and the algebraic filtration $\Lambda V \supset \Lambda^+ V \supset \dots \supset \Lambda^{> m} V \supset \dots$.

The second result above reduces the computation of $\text{cat}_0 X$ to the existence (or non-existence) of retractions $(\Lambda V \otimes \Lambda Z(m), d) \rightarrow (\Lambda V, d)$. Constructing such morphisms, however, is not easy, because they are required to be algebra morphisms. Fortunately, a magnificent theorem of Hess [90] about any Sullivan algebra over \mathbb{k} comes to our rescue (§29(e)):

- $\text{cat}(\Lambda V, d)$ is the least integer m such that there is a morphism of $(\Lambda V, d)$ -modules, $\pi_m : (\Lambda V \otimes \Lambda Z(m), d) \rightarrow (\Lambda V, d)$, such that $\pi_m \lambda_m = \text{id}_{\Lambda V}$.

Finally, in §29(g) we shall extend the notion of $e(\Lambda V, d)$ to $e(M, d)$, for any $(\Lambda V, d)$ -module (M, d) . In particular, we may consider the module $(\Lambda V, d)^\sharp = \text{Hom}_{\mathbb{k}}(\Lambda V, \mathbb{k})$ with $(a \cdot f)(b) = (-1)^{\deg a \deg f} f(ab)$, $a, b \in \Lambda V$, $f \in (\Lambda V)^\sharp$. If V is a graded vector space of finite type we use Hess’s theorem to prove the recent result of Félix, Halperin and Lemaire [55]:

- $\text{cat}(\Lambda V, d) = e((\Lambda V, d)^\sharp)$.

This section is organized into the following topics:

- The rational cone-length of spaces and the product length of models.
- The LS category of a Sullivan algebra.
- The mapping theorem for Sullivan algebras.
- Gottlieb elements.
- Hess’ theorem.
- The model of $(\Lambda V, d) \rightarrow (\Lambda V / \Lambda^{> m} V, d)$.
- The Milnor-Moore spectral sequence and Ginsburg’s theorem.
- The invariants mcat and e for $(\Lambda V, d)$ -modules.

(a) The rational cone-length of spaces and the product length of models.

Our central result provides an algebraic description of cone-length. It reads

Theorem 29.1 *Let $\mathbb{k} = \mathbb{Q}$. The following conditions are equivalent for simply connected topological space X with rational homology of finite type:*

- (i) $\text{cl}_0 X \leq n$.
- (ii) $\text{nil } A \leq n$ for some commutative model (A, d) for X with $A^0 = \mathbb{Q}$.
- (iii) X has a free Lie model (\mathbb{L}_V, d) with an increasing filtration $0 = V(0) \subset V(1) \subset \dots \subset V(n) = V$ such that for each i , $d : V(i) \rightarrow \mathbb{L}_V(i-1)$.
- (iv) There is a rational homotopy equivalence $P \rightarrow X$ from a spherical n -cone whose constituent spaces are wedges of spheres with finitely many spheres in each dimension.

The proof of the theorem requires one small technicality.

Lemma 29.2 *Suppose (A, d) is a commutative cochain algebra (over any \mathbb{k} of characteristic zero) such that $A^0 = \mathbb{k}$, $H^1(A) = 0$ and each $H^i(A)$ has finite dimension. Then there is a subcochain algebra (B, d) such that: $B^1 = 0$, each B^i is finite dimensional and $d : B^+ \rightarrow B^+ \cdot B^+$.*

proof: Choose $\hat{A} \subset A$ so that $\hat{A}^1 = 0$, $\hat{A}^2 \oplus d(A^1) = A^2$ and $\hat{A}^i = A^i$, $i \geq 3$. Then $(\hat{A}, d) \xrightarrow{\cong} (A, d)$ and so we may suppose $A^1 = 0$.

Suppose next that A^i is finite dimensional for $i < n$, and let \bar{A} be the subalgebra generated by $A^{<n}$ and $(\text{Im } d)^n$. Then \bar{A} is a sub cochain algebra and each \bar{A}^i is finite dimensional. Now write $A^n = d^{-1}(\bar{A}^{n+1}) \oplus U^n$ and choose $C \subset A$ so that (i) $C^i = A^i$, $i < n$, (ii) $C^n = d^{-1}(\bar{A}^{n+1})$, (iii) $C^{n+1} \supset \bar{A}^{n+1}$ and $C^{n+1} \oplus dU^n = A^{n+1}$ and (iv) $C^i = A^i$, $i \geq n + 2$. Then (C, d) is a sub cochain algebra including quasi-isomorphically in (A, d) and C^i is finite dimensional, $i \leq n$.

We now construct a decreasing sequence of quasi-isomorphic inclusions of sub cochain algebras $A \supset A(2) \supset A(3) \supset \dots$ as follows: if $A(k)$ is constructed so that $A^i(k)$ is finite dimensional, $i \leq k$, then $A(k + 1)$ is a subcochain algebra including quasi-isomorphically in $A(k)$ such that $A^i(k + 1) = A^i(k)$, $i \leq k$ and such that among all these $A^{k+1}(k + 1)$ has minimal dimension (necessarily finite by the argument above). Set $B = \bigcap_k A(k)$ and note that $B^i = A^i(k)$, $i \leq k$,

so that $(B, d) \xrightarrow{\cong} (A, d)$. Note as well that for any proper sub cochain algebra $(\hat{B}, d) \subset (B, d)$ the inclusion is *not* a quasi-isomorphism.

Let $\zeta : B \rightarrow \mathbb{k} \oplus B^+ / B^+ \cdot B^+$ be the projection and let $Q(d)$ be the differential in $B^+ / B^+ \cdot B^+$. If $\ker Q(d) = H \oplus \text{Im } Q(d)$ then $\zeta^{-1}(\mathbb{k} \oplus H)$ is a sub cochain algebra including quasi-isomorphically in B . Thus $\zeta^{-1}(\mathbb{k} \oplus H) = B$ and $H = B^+ / B^+ \cdot B^+$; i.e., $Q(d) = 0$. □

proof of Theorem 29.1: (i) \Rightarrow (ii). If $\text{cl}_0 X = 1$ then $X \simeq \Sigma Y$ for a well-based space Y , and the desired conclusion is exactly Proposition 13.9. For $n > 1$ we may suppose $X = Y \cup_f \bar{C}Z$ where $\text{cl}_0 Y \leq n - 1$ and Z and Y are path connected. Let $m_Y : (\Lambda V_Y, d) \rightarrow A_{PL}(Y)$ be a Sullivan model and extend

$A_{PL}(f)m_Y$ to a Sullivan model $m_Z : (\Lambda V_Y \otimes \Lambda V, d) \xrightarrow{\cong} A_{PL}(Z)$. Then the inclusion $\lambda : \Lambda V_Y \rightarrow \Lambda V_Y \otimes \Lambda V$ is a Sullivan representative for f .

As usual, let $\Lambda(t, dt)$ be the free commutative cochain algebra on generators t and dt of degrees zero and one and let $\varepsilon_1 : \Lambda(t, dt) \rightarrow \mathbb{Q}$ be the augmentation sending $t \mapsto 1$. The morphisms $\xrightarrow{\lambda} \xleftarrow{id \otimes \varepsilon_1}$ define a fibre product $\Lambda V_Y \times_{\Lambda V_Y \otimes \Lambda V} (\mathbb{Q} \oplus [\Lambda V_Y \otimes \Lambda V \otimes \Lambda^+(t, dt)])$, and Proposition 13.8 identifies this as a commutative model for X .

By induction there is a quasi-isomorphism of commutative cochain algebras $(\Lambda V_Y, d) \rightarrow (B, d)$, where $B^0 = \mathbb{Q}$ and $\text{nil } B \leq n - 1$. Apply $B \otimes_{\Lambda V_Y} -$ to obtain a quasi-isomorphism $(\Lambda V_Y \otimes \Lambda V, d) \xrightarrow{\cong} (B \otimes \Lambda V, d)$ as described in Lemma 14.2. This identifies $B \times_{B \otimes \Lambda V} (\mathbb{Q} \oplus [B \otimes \Lambda V \otimes \Lambda^+(t, dt)])$ as a commutative model for X . This contains $(A, d) = B \times_{B \otimes \Lambda V} (\mathbb{Q} \oplus [B^+ \otimes \Lambda V \otimes \Lambda^+(t, dt)] \oplus (\Lambda V \otimes dt))$ as a sub cochain algebra. Since the inclusion of dt in $\Lambda^+(t, dt) \cap \ker \varepsilon_1$ is a quasi-isomorphism, so is the inclusion of (A, d) in the fibre product. Thus (A, d) is a commutative model for X satisfying $\text{nil } A \leq n$.

(ii) ⇒ (iii). If (ii) holds we may use Lemma 29.2 to find a commutative model (B, d) for X such that $B^0 = \mathbb{Q}$, $B^1 = 0$, each B^i is finite dimensional, $d : B^+ \rightarrow B^+ \cdot B^+$ and also $\text{nil } B \leq n$. Then $\mathcal{L}_{(B,d)}$ is a Lie model for X (§23(a)). Now $\mathcal{L}_{(B,d)} = \mathbb{L}_V$ with $V = s^{-1} \text{Hom}(B^+, \mathbb{Q})$. Put $I(k) = B^+ \cdots \cdots B^+$ ($k+1$ factors) and dualize the sequence

$$0 \leftarrow B^+ / I(1) \leftarrow B^+ / I(2) \leftarrow \cdots \leftarrow B^+ / I(n) = B^+$$

to obtain a filtration of V . The facts that $B^+ \cdot I(k) \subset I(k+1)$ and $d : I(k) \rightarrow I(k+1)$ imply that the filtration on V has the stated properties, as follows immediately from the definition of the differential in $\mathcal{L}_{(B,d)}$.

(iii) ⇒ (iv). We may clearly suppose X is a CW complex. It follows at once from Theorem 24.7 that (\mathbb{L}_V, d) is the Lie model of a space of the form P . This means that X and P have the same rational homotopy type, and so there is a weak homotopy equivalence $X_{\mathbb{Q}} \xrightarrow{\cong} P_{\mathbb{Q}}$. Now apply Lemma 28.4 to the composite $X \rightarrow P_{\mathbb{Q}}$.

(iv) ⇒ (i). This is obvious. □

(b) The LS category of a Sullivan algebra.

We begin by proving

Proposition 29.3

(i) Let $(\Lambda V, d)$ be a Sullivan algebra. Then $\text{cat}(\Lambda V, d) \leq m$ if and only if there

is a diagram of commutative cochain algebras

$$\begin{array}{ccccc}
 (\Lambda V, d) & \xrightarrow{\alpha} & (A, d) & \xrightarrow{\beta} & (C, d) \\
 & & \downarrow \simeq \eta & & \\
 & & (B, d) & &
 \end{array}$$

in which $\beta\alpha$ is a quasi-isomorphism and $\text{nil } B \leq m$.

(ii) If $(\Lambda V, d)$ and $(\Lambda W, d)$ are quasi-isomorphic Sullivan algebras then $\text{cat}(\Lambda V, d) = \text{cat}(\Lambda W, d)$.

proof: (i) Recall the diagram at the start of this section. If $\text{cat}(\Lambda V, d) \leq m$, that diagram, together with the retraction $(\Lambda V \otimes \Lambda Z(m), d) \rightarrow (\Lambda V, d)$ satisfies the Proposition. Conversely, given such a diagram note that $\eta\alpha$ factors to yield $\gamma : (\Lambda V / \Lambda^{>m} V, d) \rightarrow (B, d)$ with $\gamma\varrho_m = \eta\alpha$. In the diagram

$$\begin{array}{ccc}
 (\Lambda V, d) & \xrightarrow{\alpha} & (A, d) \\
 \lambda_m \downarrow & & \downarrow \simeq \eta \\
 (\Lambda V \otimes \Lambda Z(m), d) & \xrightarrow{\gamma\varrho_m} & (B, d)
 \end{array}$$

we may extend α to a morphism $\zeta : (\Lambda V \otimes \Lambda Z(m), d) \rightarrow (A, d)$ such that $\eta\zeta \sim \gamma\varrho_m \text{ rel } (\Lambda V, d)$. Finally, in the commutative diagram

$$\begin{array}{ccc}
 (\Lambda V, d) & \xrightarrow[=]{id} & (\Lambda V, d) \\
 \lambda_m \downarrow & & \downarrow \simeq \beta\alpha \\
 (\Lambda V \otimes \Lambda Z(m), d) & \xrightarrow{\beta\zeta} & (C, d)
 \end{array}$$

we may extend $id_{\Lambda V}$ to a retraction $\pi_m : (\Lambda V \otimes \Lambda Z(m), d) \rightarrow (\Lambda V, d)$.

(ii) This is a trivial consequence of (i). □

Corollary 1 Suppose for some $n \geq r \geq 1$ that the non-zero elements of $H^+(\Lambda V, d)$ are concentrated in degrees i with $r \leq i \leq n$. Then

$$\text{cat}(\Lambda V, d) \leq n/r .$$

proof: It is easy to construct a quasi-isomorphism $(\Lambda V, d) \xrightarrow{\cong} (B, d)$ in which B^+ is concentrated in degrees i , $r \leq i \leq n$. Then $\text{nil } B \leq n/r$. Apply the Proposition. \square

Corollary 2 $\text{nil } H(\Lambda V, d) \leq e(\Lambda V, d) \leq \text{cat}(\Lambda V, d) \leq \text{nil } A$ for any commutative model (A, d) of $(\Lambda V, d)$. In particular, if $H(\Lambda V, d)$ is finite dimensional then $\text{cat}(\Lambda V, d) \leq \max\{i \mid H^i(\Lambda V, d) \neq 0\}$.

proof: The inequalities are immediate, the first two from the definitions and the third from the Proposition. Finally, if $H(\Lambda V, d)$ is zero in degrees $> n$ then $H(I) = 0$ where I is the ideal defined by $I = (\Lambda V)^{>n} \oplus U^n$, with U^n chosen so $(\Lambda V)^n = U^n \oplus (\ker d)^n$. Thus $(\Lambda V, d) \rightarrow (\Lambda V/I, d)$ is a quasi-isomorphism and $\text{cat}(\Lambda V, d) \leq \text{nil}(\Lambda V/I) \leq n$. \square

Next we establish

Proposition 29.4 *Suppose $(\Lambda V, d)$ is a rational Sullivan model for a simply connected space X with rational homology of finite type. Then*

$$\text{cat}(\Lambda V, d) = \text{cat}_0 X \quad \text{and} \quad e(\Lambda V, d) = e_0 X .$$

proof: We may suppose X is a rational CW complex, so that $\text{cat}_0 X = \text{cat } X$ (Proposition 28.1). Recall the quasi-isomorphism $\zeta_m : (\Lambda V \otimes \Lambda Z(m), d) \xrightarrow{\cong} (\Lambda V/\Lambda^{>m}V, d)$ defined at the start of this section. The Sullivan algebra $(\Lambda V \otimes \Lambda Z(m), d)$ is a Sullivan model for the realization $Y = |\Lambda V \otimes \Lambda Z(m), d|$, as we showed in Theorem 17.10. Thus $(\Lambda V/\Lambda^{>m}V, d)$ is a commutative model for Y , which implies that $\text{cl}_0(Y) \leq m$ (Theorem 29.1). Since Y is a rational CW complex, Y has the homotopy type of an m -cone (Proposition 28.3).

Suppose $\text{cat}(\Lambda V, d) = m$. Then there is a morphism $\pi_m : (\Lambda V \otimes \Lambda Z(m), d) \rightarrow (\Lambda V, d)$ such that $\pi_m \lambda_m = \text{id}$. Thus $|\lambda_m| |\pi_m| = \text{id}_{|\Lambda V, d|}$ and $|\Lambda V, d|$ is a retract of Y . Since $|\Lambda V, d| \simeq_{\mathbb{Q}} X$ (Theorem 17.12) it follows that $\text{cat}_0 X \leq \text{cat } |\Lambda V, d| \leq m$.

Conversely, if $\text{cat}_0 X = m$ then $\text{cat } X = m$ and X is a homotopy retract of an m -cone P (Theorem 27.10). Let $(\Lambda V, d) \xrightarrow{\varphi} (\Lambda V_P, d) \xrightarrow{\psi} (\Lambda V, d)$ be Sullivan representatives respectively for the retraction and the inclusion. Then $\psi\varphi$ is a quasi-isomorphism and hence an isomorphism (Theorem 14.11). Moreover, Theorem 29.1 provides a quasi-isomorphism $\zeta : (\Lambda V_P, d) \xrightarrow{\cong} (A, d)$ with $\text{nil } A \leq m$. Thus $\text{cat}(\Lambda V, d) \leq m$ (Proposition 29.3).

Finally, since $e_0 X = e(X; \mathbb{Q})$ this is the least integer, r , such that there is a continuous map f of X into an r -cone such that $H^r(f; \mathbb{Q})$ is injective (Proposition 28.1). Now a simplified version of the argument above shows that $e(\Lambda V, d) = e_0 X$. \square

Corollary *Suppose $(\Lambda V, d)$ is any rational Sullivan algebra with $V = \{V^i\}_{i \geq 2}$ a graded vector space of finite type. Then the spatial realization (§17) $|\Lambda V, d|$ is*

a rational space satisfying

$$\text{cat} |\Lambda V, d| = \text{cat}(\Lambda V, d) .$$

proof: According to Theorem 17.10, $|\Lambda V, d|$ is a simply connected rational topological space with $(\Lambda V, d)$ as a Sullivan model. Thus $\text{cat} |\Lambda V, d| = \text{cat}_0 |\Lambda V, d| = \text{cat}(\Lambda V, d)$, by Proposition 28.1 and Proposition 29.4 \square

Example 1 A space X satisfying $c_0 X < e_0 X$.

Let X be a simply connected space with Sullivan model $(\Lambda(x, y, z), d)$ where $\deg x = 3 = \deg y$, $dx = dy = 0$ and $dz = xy$. Then the cohomology algebra $H^*(X; \mathbb{Q})$ has $1, [x], [y], [xz], [yz]$ and $[x][yz]$ as basis, and so

$$c_0 X = 2 .$$

On the other hand, $\text{nil}(\Lambda(x, y, z)) = 3$ and so $3 \geq \text{cl}_0 X \geq \text{cat}_0 X \geq e_0 X$. Finally, $xyz \in \Lambda^3(x, y, z)$ represents a non-trivial cohomology class, so $e_0 X \geq 3$. Thus

$$e_0 X = \text{cat}_0 X = \text{cl}_0 X = 3 . \quad \square$$

Example 2 (Lemaire-Sigrist [111]) A space X satisfying $e_0 X < \text{cat}_0 X$.

Consider the commutative cochain algebra (A, d) given by

$$A = \Lambda(x, y, t)/(x^4, xy, xt) , \quad dx = dy = 0, \quad dt = x^3 ,$$

with $\deg x = 2$, $\deg y = 3$ and $\deg t = 5$. Evidently

$$\text{nil}(A, d) = 3 .$$

Thus if X is a simply connected space with (A, d) as commutative model then

$$\text{cat}_0 X \leq \text{cl}_0 X = 3 .$$

A vector space basis for A^+ is given by x, x^2, x^3, y, t, yt and so a vector space basis for $H^+(A)$ is given by $[x], [x]^2, [y], [yt]$. In particular, $H(A)$ is concentrated in degrees ≤ 7 . A minimal Sullivan model $(\Lambda V, d)$ for (A, d) has the form $m : \Lambda(x, y, z, t, \dots) \rightarrow A$ with $mx = x, my = y, mz = 0, mt = t$ and $dz = xy$; the remaining generators all have degree at least 7. In particular $\Lambda^{\geq 3} V = \mathbb{k}zx^2 \oplus (\Lambda^{\geq 3} V)^{>7}$. Since zx^2 is not a cocycle no cohomology class can be represented by a cocycle in $\Lambda^{\geq 3} V$:

$$e_0(X) = e(\Lambda V, d) = 2 .$$

Finally, we show that $\text{cat}(\Lambda V, d) > 2$, thereby establishing

$$\text{cl}_0(X) = \text{cat}_0(X) = \text{cat}(\Lambda V, d) = 3 .$$

Thus in particular, $e_0(X) < \text{cat}_0(X)$. In fact, let $\rho : (\Lambda V, d) \rightarrow (\Lambda V/\Lambda^{>2}V, d)$ be the projection. If $\text{cat}(\Lambda V, d) \leq 2$ then there is a morphism of graded algebras $\varphi : H(\Lambda V/\Lambda^{>2}V) \rightarrow H(\Lambda V)$ such that $\varphi H(\rho) = \text{id}$. Now t becomes a cocycle in $\Lambda V/\Lambda^{>2}V$ and so we would have $[yt+x^2z] \xrightarrow{H(\rho)} [y][t] \xrightarrow{\varphi} 0$. Since $[yt+x^2z] \mapsto [yt]$ in $H(A)$, $[yt+x^2z] \neq 0$ and this contradiction proves $\text{cat}(\Lambda V, d) > 2$. \square

Example 3 (*Dupont* [45]) *A space X satisfying $\text{cat}_0 X < \text{cl}_0 X$.*

Let (L, d) be the free differential graded Lie algebra $\mathbb{L}(a, b, x, y)$ with $\text{deg } a = 3$, $\text{deg } b = 5$, $\text{deg } x = 7$, $\text{deg } y = 11$ and $da = db = 0$, $dx = [a, a]$, $dy = [a, x] + [b, b]$. Let $(L', d) = (\mathbb{L}(a', b', x', y'), d)$ be a copy of L and extend $\mathbb{L}(a, b, x, y, a', b', x', y')$ to the free dgl $\mathbb{L}(a, b, x, y, a', b', x', y', a'', u, u', b'', v)$ by requiring

$$da'' = [a, a'], \quad du = [a, b'], \quad du' = [a', b], \quad db'' = [b, b']$$

and

$$dv = [[a, [b, b]], 4[a', y'] + [x', x']] - \gamma,$$

where $\gamma \in \mathbb{L}(a, b, a', b', a'', u, u', b'')$ has bracket length 5 and satisfies $d\gamma = 4[[a, [b, b]], [a', [b', b']]]$.

In [45] Dupont shows that if X is a simply connected space with Lie model (L, d) then

$$\text{cl}_0 X = 4 \quad \text{and} \quad \text{cat}_0 X = 3.$$

Since the argument is lengthy and difficult, we do not reproduce it here. \square

Example 4 *Formal spaces.*

Let X be a simply connected topological space with rational homology of finite type. If X is formal then

$$c_0(X) = e_0(X) = \text{cat}_0 X = \text{cl}_0 X.$$

In fact, since X is formal $H^*(X)$ is a commutative model for X . Thus $c_0(X) = \text{nil } H^*(X) \geq \text{cl}_0 X$, by Theorem 29.1. The reverse inequalities are established in Theorem 28.5. \square

Example 5 *Coformal spaces.*

Recall that a simply connected topological space X with rational homology of finite type is coformal if it has a Lie model of the form $(L, 0)$ — Example 7, §24 (f). Equivalently X has a purely quadratic Sullivan model $(\Lambda V, d_1)$. We show for coformal spaces that

$$e_0(X) = \text{cat}_0(X) = \text{cl}_0 X.$$

In fact, suppose $e_0(X) = r$. Choose a vector space complement S for $\ker d_1$ in $\Lambda^r V$. Then $I = S \oplus \Lambda^{>r} V$ is an acyclic ideal and $(\Lambda V/I, d)$ is a commutative model for X . Since $\text{nil}(\Lambda V/I, d) = r$ we have (Theorem 29.1) that $r \geq \text{cl}_0 X$. The reverse inequalities are always true, as in Example 1. \square

Example 6 *Minimal Sullivan algebras $(\Lambda V, d)$ with $V = V^{\text{odd}}$ and $\dim V < \infty$.*

If $(\Lambda V, d)$ is as in the title of the example, let $r = \dim V$. Then $\Lambda V = \bigoplus_{i=0}^r \Lambda^i V$, $\dim \Lambda^r V = 1$ and the elements in $\Lambda^r V$ are cocycles and not coboundaries. Thus $e(\Lambda V, d) = r = \text{nil}(\Lambda V, d)$ and hence $e(\Lambda V, d) = \text{cat}(\Lambda V, d) = r$. \square

Example 7 $(\Lambda V, d) = \Lambda(a, b, x, y, z)$ with $dx = a^2$, $dy = b^2$ and $dz = ab$.

In this example we take $\deg a = 2$, $\deg b = 2$, but any even degrees would do. Hence $(\Lambda V, d) \xrightarrow{\cong} \Lambda a/a^2 \otimes \Lambda b/b^2 \otimes \Lambda z$, and this commutative model (A, d) has $\text{nil } A = 3$. A non trivial cohomology class is represented by $abz - xb^2$ and so $e(\Lambda V, d) \geq 3$. It follows that $e(\Lambda V, d) = \text{cat}(\Lambda V, d) = 3$. \square

(c) The mapping theorem for Sullivan algebras.

The Mapping theorem 28.6 for topological spaces (§28(c)) has an analogue for Sullivan algebras. In the case $\mathbb{k} = \mathbb{Q}$ and the spaces and algebras have finite dimensional cohomology in each degree Theorem 28.6 follows from the theorem for Sullivan algebras, which reads:

Theorem 29.5 *Suppose $\varphi : (\Lambda V, d) \rightarrow (\Lambda W, d)$ is a morphism of minimal Sullivan algebras with $V = \{V^i\}_{i \geq 2}$ and $W = \{W^i\}_{i \geq 2}$.*

- (i) *If φ is surjective then $\text{cat}(\Lambda V, d) \geq \text{cat}(\Lambda W, d)$.*
- (ii) *If there are r elements of odd degree, $w_1, \dots, w_r \in W$ such that $\Lambda W = \text{Im } \varphi \cdot \Lambda(w_1, \dots, w_r)$ then $\text{cat}(\Lambda V, d) + r \geq \text{cat}(\Lambda W, d)$.*

proof: (i) Extend φ to a quasi-isomorphism $\eta : (\Lambda V \otimes \Lambda Z, d) \xrightarrow{\cong} (\Lambda W, d)$ from a minimal relative Sullivan algebra, and let $\rho : (\Lambda V \otimes \Lambda Z, d) \rightarrow (\Lambda Z, \bar{d})$ be the surjection obtained by setting $V = 0$. Choose a quasi-isomorphism $\psi : (\Lambda W, d) \xrightarrow{\cong} (\Lambda V \otimes \Lambda Z, d)$ such that $\eta\psi = \text{id}$ (Lemma 12.4). We first establish

$$\bullet \text{ The differential } \bar{d} \text{ in } \Lambda Z \text{ is zero.} \tag{29.6}$$

and

$$\bullet \psi(\Lambda^+ W) \subset \Lambda^+ V \otimes \Lambda Z. \tag{29.7}$$

Indeed let $(\Lambda V \otimes \Lambda \bar{V}, D) \xrightarrow{\cong} \mathbb{k}$ be a minimal Sullivan model for the augmentation $\Lambda V \rightarrow \mathbb{k}$. Thus (§14(a)) ρ extends to a quasi-isomorphism $(\Lambda V \otimes \Lambda \bar{V}) \otimes_{\Lambda V} (\Lambda V \otimes \Lambda Z) \xrightarrow{\cong} (\Lambda Z, \bar{d})$. Moreover $\text{id} \otimes \eta : (\Lambda V \otimes \Lambda \bar{V}) \otimes_{\Lambda V} (\Lambda V \otimes \Lambda Z) \xrightarrow{\cong} (\Lambda V \otimes \Lambda \bar{V}) \otimes_{\Lambda V} \Lambda W$ and so $(\Lambda Z, \bar{d}) \simeq \Lambda W \otimes_{\Lambda V} (\Lambda V \otimes \Lambda \bar{V}) = (\Lambda W \otimes \Lambda \bar{V}, \delta)$. The linear part, δ_0 , of δ is the map $Q(\varphi)D_0 : \bar{V} \rightarrow W$, where $Q(\varphi)$ is the linear part of φ .

Now $(\Lambda V \otimes \Lambda \bar{V}, D)$ is contractible, because it is a Sullivan algebra quasi-isomorphic to \mathbb{k} (Theorem 14.9). Thus $D_0 : \bar{V} \xrightarrow{\cong} V$ and so δ_0 is surjective. Write $\bar{V} = \bar{V}_0 \oplus \bar{V}_1$ with $\bar{V}_0 = \ker \delta_0$. Then recall (Example of §14(a)) that

the quotient differential in $\Lambda\bar{V}$ is zero. Thus a composite morphism $\gamma : (\Lambda W \otimes \Lambda\bar{V}, \delta) \rightarrow (\Lambda\bar{V}, 0) \rightarrow (\Lambda\bar{V}_0, 0)$ is defined by setting first W and then \bar{V}_1 to zero. By construction $H(Q(\gamma))$ is an isomorphism and hence γ is a quasi-isomorphism (Proposition 14.13). This shows that $(\Lambda\bar{V}_0, 0)$ is a minimal Sullivan model for $(\Lambda W \otimes \Lambda\bar{V}, \delta)$. It follows that $(\Lambda Z, \bar{d}) \cong (\Lambda\bar{V}_0, 0)$, which proves (29.6).

For the proof of (29.7) let $\lambda : (\Lambda V, d) \rightarrow (\Lambda V \otimes \Lambda Z, d)$ be the inclusion. Then $\eta\lambda = \varphi = \eta\psi\varphi$ and so $\lambda \sim \psi\varphi$ (Proposition 12.9). Thus $\varrho\lambda \sim \varrho\psi\varphi : (\Lambda V, d) \rightarrow (\Lambda Z, 0)$. But $\varrho\lambda$ is the augmentation in ΛV and so the Example in §12(b) asserts that $\varrho\lambda = \varrho\psi\varphi$. In other words, $\varrho\psi(\Lambda^+W) = \varrho\psi\varphi(\Lambda^+V) = 0$, which proves (29.7).

Finally, we suppose $\text{cat}(\Lambda V, d) = m$ and deduce that $\text{cat}(\Lambda W, d) \leq m$. Let

$$\begin{array}{ccccc}
 (\Lambda V, d) & \xrightarrow{\lambda_m} & \Lambda V \otimes \Lambda Z(m) & \xrightarrow{\pi_m} & (\Lambda V, d) \\
 & \searrow e_m & \downarrow \simeq \zeta_m & & \\
 & & (\Lambda V / \Lambda^{>m}V, d) & &
 \end{array}$$

be as described at the start of the section. Apply $- \otimes_{\Lambda V} (\Lambda V \otimes \Lambda Z, d)$ to the augmentation ideals of this diagram to obtain

$$\begin{array}{ccccc}
 ([\Lambda V]^+ \otimes \Lambda Z, d) & \longrightarrow & ([\Lambda V \otimes \Lambda Z(m)]^+ \otimes \Lambda Z, d) & \longrightarrow & ([\Lambda V]^+ \otimes \Lambda Z, d) \\
 & & \downarrow \simeq & & \\
 & & ([\Lambda V / \Lambda^{>m}V]^+ \otimes \Lambda Z, d) & &
 \end{array}$$

where the vertical arrow is a quasi-isomorphism because $(\Lambda V \otimes \Lambda Z, d)$ is $(\Lambda V, d)$ -semifree (Lemma 14.1 and Proposition 6.7). Now (29.7) states that ψ factors as $(\Lambda W, d) \rightarrow (\mathbb{k} \oplus [\Lambda V]^+ \otimes \Lambda Z, d) \rightarrow (\Lambda V \otimes \Lambda Z, d)$. Thus it also factors as

$$\begin{array}{ccccc}
 (\Lambda W, d) & \longrightarrow & (\mathbb{k} \oplus [\Lambda V \otimes \Lambda Z(m)]^+ \otimes \Lambda Z, d) & \longrightarrow & (\Lambda V \otimes \Lambda Z, d) \\
 & & \downarrow \simeq & & \\
 & & (\mathbb{k} \oplus [\Lambda V / \Lambda^{>m}V]^+ \otimes \Lambda Z, d) & &
 \end{array}$$

Since the lower cochain algebra has product length m this is exactly the situation envisaged in Proposition 29.3, which therefore asserts that $\text{cat}(\Lambda W, d) \leq m$.

(ii) This is proved by induction on r , the case $r = 0$ being precisely assertion (i). Assume $\text{deg } w_1 \leq \dots \leq \text{deg } w_r$. Set $\text{deg } w_1 = p$ and put $(\Lambda Z, d) = (\Lambda W^{<p}, d) \otimes_{(\Lambda V^{<p}, d)} (\Lambda V, d) = (\Lambda W^{<p} \otimes \Lambda V^{\geq p}, d)$. Then φ factors as $(\Lambda V, d) \xrightarrow{\psi} (\Lambda Z, d) \xrightarrow{\psi'} (\Lambda W, d)$ and ψ is surjective. It follows that $\text{Im } \psi' \cdot \Lambda(w_1, \dots, w_r) = \Lambda W$ and (by assertion (i)) that $\text{cat}(\Lambda V, d) \geq \text{cat}(\Lambda Z, d)$.

Thus it is sufficient to prove assertion (ii) for ψ' ; i.e., without loss of generality we may and do assume that φ is an isomorphism from $\Lambda V^{<p}$ to $\Lambda W^{<p}$. Since V and W are concentrated in degrees ≥ 2 , and since $(\Lambda W, d)$ is minimal, dw_1 is a cocycle in $\Lambda W^{<p}$. Extend φ to a morphism $\eta : (\Lambda V \otimes \Lambda u, d) \rightarrow (\Lambda W, d)$ by setting $du = \varphi^{-1}dw_1$ and $\eta u = w_1$. By induction, $\text{cat}(\Lambda W, d) \leq \text{cat}(\Lambda V \otimes \Lambda u, d) + r - 1$. It remains to prove $\text{cat}(\Lambda V \otimes \Lambda u, d) \leq \text{cat}(\Lambda V, d) + 1$.

For this, apply $- \otimes_{\Lambda V} (\Lambda V \otimes \Lambda u, d)$ to the diagram of Proposition 29.3(i), with $\text{nil } B = \text{cat}(\Lambda V, d)$. Now $B \otimes_{\Lambda V} (\Lambda V \otimes \Lambda u) = B \otimes \Lambda u$. Since $\deg u$ is odd, $\text{nil}(B \otimes_{\Lambda V} (\Lambda V \otimes \Lambda u)) = \text{nil } B + 1$. Since $- \otimes_{\Lambda V} (\Lambda V \otimes \Lambda u, d)$ preserves quasi-isomorphisms it follows immediately from Proposition 29.3(i) that $\text{cat}(\Lambda V \otimes \Lambda u, d) \leq \text{nil } B + 1 \leq \text{cat}(\Lambda V, d) + 1$. \square

Example 1 $e((\Lambda V, d) \otimes (\Lambda W, d)) = e(\Lambda V, d) + e(\Lambda W, d)$.

Let $(\Lambda V, d)$ and $(\Lambda W, d)$ be any minimal Sullivan algebras. Then $e(\Lambda V, d)$ is the least integer r such that $(\Lambda V, d) \rightarrow (\Lambda V/\Lambda^{>r}V, d)$ is injective in cohomology. Thus it is the greatest integer r such that $\Lambda V^{\geq r}$ contains a cocycle v representing a non-zero class in $H(\Lambda V)$.

Let $s = e(\Lambda W, d)$ and $w \in \Lambda^{\geq s}W$ be a cocycle representing a non-zero class in $H(\Lambda W)$. Then $v \otimes w \in \Lambda^{\geq r+s}(V \otimes W)$ and $[v \otimes w] \neq 0$, so $e((\Lambda V, d) \otimes (\Lambda W, d)) \geq r + s$.

Conversely the surjection $\Lambda V \otimes \Lambda W \rightarrow \Lambda V/\Lambda^{>r}V \otimes \Lambda W/\Lambda^{>s}W$ is injective in cohomology, and its kernel contains $\Lambda^{>r+s}(V \oplus W)$. Thus $e((\Lambda V, d) \otimes (\Lambda W, d)) \leq r + s$; i.e. $e((\Lambda V, d) \otimes (\Lambda W, d)) = e(\Lambda V, d) + e(\Lambda W, d)$. \square

Example 2 $\text{cat}_0 X - e_0 X$ can be arbitrarily large.

Let X be the space of Example 2, §29(b). Its minimal Sullivan model $(\Lambda V, d)$ satisfies $\text{cat}(\Lambda V, d) = 3$ and $e(\Lambda V, d) = 2$, and has the form $\Lambda(x, y, z, t, u, v, \dots)$ with $dx = dy = 0, dz = xy, dt = x^3, du = zy, dv = z^2 - 2ux$ and with $\deg x = 2, \deg y = 3, \deg z = 4, \deg t = 5, \deg u = 6$ and $\deg v = 7$. Set u and y to zero to define a surjection

$$(\Lambda(x, y, z, t, u, v), d) \rightarrow (\Lambda(x, z, t, v), \bar{d})$$

with $\bar{d}x = \bar{d}z = 0, \bar{d}t = x^3$ and $\bar{d}v = z^2$; denote this quotient Sullivan algebra by $(\Lambda W, \bar{d})$. Then $H(\Lambda W, \bar{d})$ is concentrated in degrees ≤ 8 while the remaining elements of V have degrees at least 8. It follows that the surjection above extends to a surjective morphism $\varphi : (\Lambda V, d) \rightarrow (\Lambda W, \bar{d})$. Taking tensor products we obtain surjective morphisms

$$\otimes^n \varphi : (\Lambda V, d)^{\otimes n} \rightarrow (\Lambda W, \bar{d})^{\otimes n} .$$

The cocycle zx^2 in $\Lambda^3 W$ represents a non trivial cohomology class. Thus $e(\Lambda W, d) \geq 3$ and $e((\Lambda W, d)^{\otimes n}) \geq 3n$ (Example 1). Now apply the Mapping theorem 29.5 to obtain

$$\text{cat}(\Lambda V, d)^{\otimes n} \geq \text{cat}(\Lambda W, \bar{d})^{\otimes n} \geq e(\Lambda W, \bar{d}) \geq 3n .$$

On the other hand, again by Example 1,

$$e(\Lambda V, d)^{\otimes n} = n e(\Lambda V, d) = 2n .$$

Thus if $X^n = X \times \cdots \times X$ (n factors),

$$\text{cat}_0(X^n) \geq 3n \quad \text{and} \quad e_0(X^n) = 2n .$$

(In fact, it is not too hard to show that $\text{cat}_0(X^n) = 3n$.) □

(d) Gottlieb elements.

A *Gottlieb element* of degree n for a minimal Sullivan algebra $(\Lambda V, d)$ is a linear map $f : V^n \rightarrow \mathbb{k}$ that extends to a derivation θ of $(\Lambda V, d)$, that is, a derivation of ΛV satisfying $\theta d = (-1)^n d\theta$. The Gottlieb elements form a graded subspace $G_*(\Lambda V, d) \subset \text{Hom}(V, \mathbb{k})$.

Now suppose X is a simply connected topological space with rational homology of finite type. Recall that the choice of a rational minimal Sullivan model $m : (\Lambda V, d) \xrightarrow{\cong} A_{PL}(X)$ determines an isomorphism

$$\nu_X : V \xrightarrow{\cong} \text{Hom}_{\mathbb{Q}}(\pi_*(X_{\mathbb{Q}}), \mathbb{Q}) ,$$

as follows from Theorem 15.11.

Proposition 29.8 *The dual of ν_X restricts to an isomorphism (§28(d))*

(i) $G_*(\Lambda V, d) \xrightarrow{\cong} G_*(X_{\mathbb{Q}})$.

(ii) *If $(\Lambda W, d)$ is any minimal Sullivan algebra with $W = \{W^p\}_{p \geq 2}$ and $\text{cat}(\Lambda W, d) \leq m$ then $G_*(\Lambda W, d)$ is concentrated in odd degrees, and $\dim G_*(\Lambda W, d) \leq m$.*

proof: (i) Write $H^*(S^n) = \mathbb{k} \oplus \mathbb{k}e$, where $e \in H^n(S^n)$ is dual to the fundamental class of S^n . Any continuous map $g : S^n \times X_{\mathbb{Q}} \rightarrow X_{\mathbb{Q}}$ is represented by a morphism $\varphi : (\Lambda V, d) \rightarrow H^*(S^n) \otimes (\Lambda V, d)$ and conversely, any such morphism represents a continuous map (Theorem 17.15). The maps g such that $g \Big|_{X_{\mathbb{Q}}} \sim id$ correspond to the morphisms φ of the form

$$\varphi z = 1 \otimes z + e \otimes \theta z ,$$

in which case θ is automatically a derivation of degree $-n$ in $(\Lambda V, d)$.

Thus $f : V^n \rightarrow \mathbb{Q}$ corresponds to a Gottlieb element of $X_{\mathbb{Q}}$ if and only if $f \in G_n(\Lambda V, d)$.

(ii) Suppose $0 \neq f \in G_{2k}(\Lambda W, d)$, and extend it to a derivation θ of $(\Lambda W, d)$. Then $\theta = 0$ in $\Lambda W^{<2k}$ and so dividing by $\Lambda^+ W^{<2k} \cdot \Lambda W$ we obtain a derivation $\bar{\theta}$ in $(\Lambda W^{\geq 2k}, \bar{d})$ restricting to f in W^{2k} . Choose $w \in W^{2k}$ so that

$\bar{\theta}(w) = f(w) = 1$. Clearly $\bar{d}w = 0$ and $\bar{\theta}^k(w^k) = k!$. Thus w^k cannot be a coboundary and $\text{nil } H(\Lambda W^{\geq 2k}, \bar{d}) = \infty$. Now apply the Mapping theorem 29.5 to conclude $\text{cat}(\Lambda W, d) \geq \text{cat}(\Lambda W^{\geq 2k}, \bar{d}) \geq \text{nil } H(\Lambda W^{\geq 2k}, \bar{d}) = \infty$.

On the other hand if $0 \neq f \in G_{2n+1}(\Lambda W, d)$, extend f to a derivation θ of $(\Lambda W, d)$ and define a morphism $\varphi : (\Lambda W, d) \rightarrow (\Lambda u, 0) \otimes (\Lambda W, d)$ of Sullivan algebras by $\varphi : \Phi \mapsto 1 \otimes \Phi + u \otimes \theta\Phi$ (here $\text{deg } u = 2n + 1$). If $\varphi_1, \dots, \varphi_r$ correspond to Gottlieb elements f_1, \dots, f_r of odd degree then form the composite morphism

$$\rho \circ (id \otimes \varphi_1) \circ \dots \circ \varphi_1 : (\Lambda W, d) \rightarrow (\Lambda(u_1, \dots, u_r), 0) \otimes (\Lambda W, d) \rightarrow (\Lambda(u_1, \dots, u_r), 0)$$

If the f_i are linearly independent then this morphism is surjective and so $\text{cat}(\Lambda W, d) \geq \text{cat}(\Lambda(u_1, \dots, u_r), 0) = r$. □

Example 1 *A non-trivial Gottlieb element.*

Let (A, d) be the commutative cochain algebra defined by $A = \Lambda(a, b, x, y)/abxy$ with $\text{deg } a = \text{deg } b = \text{deg } x = 3$ and $dy = abx$. The Sullivan model for (A, d) has the form $(\Lambda V, d) = \Lambda(a, b, x, y, z, \dots)$ with $dz = abxy$. We show that *the map $f : y \mapsto 1$ is a Gottlieb element for $(\Lambda V, d)$.*

In fact extend f to a derivation θ of $(\Lambda V, d)$ by first setting $\theta z = yx$. Then note that elements of higher degree in V have degree at least 15, while $H(\Lambda V, d)$ is concentrated in degrees ≤ 11 . Thus θ extends automatically to the rest of V so as to satisfy $\theta d + d\theta = 0$.

On the other hand, suppose $(\Lambda V, d)$ is a Sullivan model for a simply connected topological space X and let $X \rightarrow Y$ be any fibration with fibre S^5 . It follows from §15(a) and a simple calculation that the inclusion $S^5 \rightarrow X$ is zero in rational homotopy. In particular the Gottlieb element f does not arise as the fibre of an S^5 -fibration. □

(e) Hess' theorem.

Fix a minimal Sullivan algebra $(\Lambda V, d)$ such that $V = \{V^i\}_{i \geq 2}$ and fix an integer n . Simplify the diagram in the introduction to

$$\begin{array}{ccc} (\Lambda V, d) & \xrightarrow{\lambda} & (\Lambda V \otimes \Lambda Z, d) \\ & \searrow e & \downarrow \simeq \zeta \\ & & (\Lambda V / \Lambda^{>n} V, d) ; \end{array}$$

in particular ζ is a minimal Sullivan model for ρ . Our goal is

Theorem 29.9 (Hess — [90]) *Assume there is a morphism*

$$\eta : (\Lambda V \otimes \Lambda Z, d) \rightarrow (\Lambda V, d)$$

of $(\Lambda V, d)$ -modules such that $\eta\lambda = id$. Then there is a morphism $\eta' : (\Lambda V \otimes \Lambda Z, d) \rightarrow (\Lambda V, d)$ of cochain algebras such that $\eta'\lambda = id$; i.e.,

$$\text{cat}(\Lambda V, d) \leq m .$$

Remark Theorem 29.9 holds even if $V^1 \neq 0$ and is so stated and proved in [90]. We limit ourselves to the case $V^1 = 0$ because the proof is then simpler. \square

The proof of Theorem 29.9 requires a technical result about the structure of $(\Lambda V \otimes \Lambda Z, d)$ which we state as Proposition 29.10 immediately below. The proof, however, will be deferred to the next topic as only the statement is required for the theorem.

Proposition 29.10 *The Sullivan model $(\Lambda V \otimes \Lambda Z, d)$ can be chosen so that $\zeta(Z) = 0$, $Z = \bigoplus_{p \geq 0} Z_p$ and*

$$(i) \quad d : Z_p \rightarrow 1 \otimes (\Lambda^2 Z)_{p-1} \oplus \left[\bigoplus_{q=0}^p \Lambda^{>q(m-1)} V \otimes Z_{p-q} \right] \oplus \Lambda^{>m+p(m-1)} V, \quad p \geq 0.$$

(ii) *The quotient differential, \bar{d} , in ΛZ satisfies*

$$\bar{d} : Z_p \xrightarrow{\cong} (\Lambda^2 Z)_{p-1} \cap \ker \bar{d}, \quad p \geq 1, \quad n \geq 1 .$$

(iii) *The inclusion of $(\Lambda V \otimes (\mathbb{k} \oplus Z_0), d)$ in $(\Lambda V \otimes \Lambda Z, d)$ is a quasi-isomorphism*

(Here $(\Lambda Z)_*$ is the grading induced by the grading Z_* .)

proof of Theorem 29.9: Regard $(\Lambda V \otimes (\mathbb{k} \oplus Z_0), d)$ as a $(\Lambda V, d)$ -bimodule by writing

$$\Omega\Phi = (-1)^{\text{deg } \Phi \text{ deg } \Omega} \Phi\Omega = (-1)^{\text{deg } \Phi \text{ deg } \Omega} \Phi \wedge \Omega, \quad \begin{array}{l} \Phi \in \Lambda V \\ \Omega \in \Lambda V \otimes (\mathbb{k} \oplus Z_0) . \end{array}$$

Then define a product in $\Lambda V \otimes (\mathbb{k} \oplus Z_0)$ by setting

$$\Omega_1 \circ \Omega_2 = (\eta\Omega_1)\Omega_2 + \Omega_1(\eta\Omega_2) - (\eta\Omega_1)(\eta\Omega_2) .$$

A simple calculation shows that this product is associative and makes $(\Lambda V \otimes (\mathbb{k} \oplus Z_0), d)$ into a commutative cochain algebra. We denote this cochain algebra by (A, d) . It is immediate that $\lambda : (\Lambda V, d) \rightarrow (A, d)$ is a morphism of cochain algebras as is the restriction $\eta_A : (A, d) \rightarrow (\Lambda V, d)$ of η .

We prove the theorem by constructing a morphism $\varphi : (\Lambda V \otimes \Lambda Z, d) \rightarrow (A, d)$ of cochain algebras such that $\varphi\lambda = \lambda$. Then $\eta' = \eta_A\varphi : (\Lambda V \otimes \Lambda Z, d) \rightarrow (\Lambda V, d)$ is the desired retraction.

First observe (Proposition 29.10 (iii)) that ζ restricts to a surjective quasi-isomorphism $(\Lambda V \otimes (\mathbb{k} \oplus Z_0), d) \rightarrow (\Lambda V / \Lambda^{>m} V, d)$. Thus its kernel, I , satisfies $H(I, d) = 0$. Moreover, since $\zeta(Z_0) = 0$, $I = \Lambda^{>m} V \oplus (\Lambda V \otimes Z_0)$.

Now we construct φ inductively to satisfy

$$(\varphi + p\eta_A\varphi) : Z_p \rightarrow I, \quad p \geq 0.$$

First, since $Z_0 \subset I$ we may set $\varphi z = z, z \in Z_0$. Suppose φ is constructed in $\Lambda V \otimes \Lambda(Z_{<p} \oplus Z_p^{<n})$, and simplify notation by writing $W = Z_{<p} \oplus Z_p^{<n}$. Set

$$U = (\Lambda^2 W)_{p-1} \oplus (\Lambda^+ V \otimes W_p) \oplus (\Lambda^{\geq m} V \otimes W_{<p}) \oplus \Lambda^{>m} V.$$

Then Proposition 29.10 (i) asserts that $dZ_p^n \subset U$. On the other hand, a trivial calculation (using the fact that φ preserves products and restricts to the identity in ΛV) shows that $(\varphi + p\eta_A\varphi)U \subset I$. Thus for $z \in Z_p^n$, $(\varphi + p\eta_A\varphi)dz$ is a cocycle in I .

Since $H(I) = 0$ there is a linear map $h : Z_p^n \rightarrow I$ such that $(\varphi + p\eta_A\varphi)dz = dhz$. Extend φ to an algebra morphism $\varphi : \Lambda V \otimes \Lambda(W \oplus Z_p^n) \rightarrow A$ by setting $\varphi z = hz - \frac{p}{p+1}\eta_A hz, z \in Z_p^n$. The equations

$$\eta_A\varphi z = \frac{1}{p+1}\eta_A hz, \quad \text{and} \quad \eta_A\varphi dz = \frac{1}{p+1}d\eta_A hz, \quad z \in Z_p^n$$

are immediate from the definitions and together give $\varphi dz = d\varphi z, z \in Z_p^n$. Finally $\varphi + p\eta_A\varphi = h : Z_p^n \rightarrow I$. This completes the inductive step, and the proof of the theorem. \square

Corollary $\text{cat}(\Lambda V, d) \leq m$ if and only if there is a diagram of $(\Lambda V, d)$ -module morphisms

$$\begin{array}{ccccc} (\Lambda V, d) & \xrightarrow{\alpha} & (P, d) & \xrightarrow{\beta} & (\Lambda V, d) \\ & & \downarrow \simeq \gamma & & \\ & & (M, d) & & \end{array}$$

in which $\beta\alpha = id, \gamma$ is a quasi-isomorphism and $\Lambda^{>m} V \cdot M = 0$.

proof: The definition of $\text{cat}(\Lambda V, d) \leq m$ provides such a diagram. Conversely given such a diagram we may (in the notation of Theorem 29.9) factor $\gamma\alpha$ as $(\Lambda V, d) \xrightarrow{\varrho} (\Lambda V / \Lambda^{>m} V, d) \xrightarrow{\theta} (M, d)$. Then, because $(\Lambda V \otimes \Lambda Z, d)$ is semifree, $\theta\zeta$ lifts through the morphism γ to yield a morphism of $(\Lambda V, d)$ -modules $\varphi : (\Lambda V \otimes \Lambda Z, d) \rightarrow (P, d)$ such that $\gamma\varphi \sim \theta\zeta$ (as morphisms of $(\Lambda V, d)$ -modules). Then $\gamma\varphi\lambda \sim \theta\zeta\lambda = \theta\varrho = \gamma\alpha$. Since γ is a quasi-isomorphism, $\varphi\lambda \sim \alpha$ (Proposition 6.4(ii)).

Set $\eta = \beta\varphi : (\Lambda V \otimes \Lambda Z, d) \rightarrow (\Lambda V, d)$. Then $\eta\lambda = \beta\varphi\lambda \sim \beta\alpha = id_{\Lambda V}$. Now $H(\eta\lambda)[1] = [1]$ and so $\eta\lambda(1) = 1$. Since $\eta\lambda$ is ΛV -linear, $\eta\lambda = id_{\Lambda V}$. By Theorem 29.9 $cat(\Lambda V, d) \leq m$. \square

Example 1 *Field extension preserves category.*

Let $(\Lambda V, d)$ be a minimal Sullivan algebra with $V = \{V^i\}_{i \geq 2}$, and let \mathbb{K} be a field extension of k . Then $(\Lambda V, d) \otimes \mathbb{K}$ is a minimal Sullivan algebra over \mathbb{K} . We show now that

$$cat(\Lambda V, d) = cat((\Lambda V, d) \otimes \mathbb{K}) .$$

Suppose $cat((\Lambda V, d) \otimes \mathbb{K}) = m$ and let

$$\begin{array}{ccccc} (\Lambda V, d) \otimes \mathbb{K} & \xrightarrow{\alpha} & (P, d) & \xrightarrow{\beta} & (\Lambda V, d) \otimes \mathbb{K} \\ & & \downarrow \gamma \simeq & & \\ & & (M, d) & & \end{array}$$

be morphisms of $(\Lambda V, d) \otimes \mathbb{K}$ modules as in the Corollary to Theorem 29.9. In particular, $\Lambda^{>m} V \cdot M = 0$ and $\beta\alpha = id$. Let $\lambda : k \rightarrow \mathbb{K}$ the inclusion and let $\pi : \mathbb{K} \rightarrow k$ be a k -linear map such that $\pi\lambda = id$. Then the identity of $(\Lambda V, d)$ factors as

$$(\Lambda V, d) \xrightarrow{\alpha\lambda} (P, d) \xrightarrow{\pi\beta} (\Lambda V, d) ,$$

and γ is also a quasi-isomorphism of $(\Lambda V, d)$ -modules. Thus the Corollary to Theorem 29.9 asserts that $cat(\Lambda V, d) \leq m$.

Conversely, if $cat(\Lambda V, d) = m$ we can apply $- \otimes \mathbb{K}$ to the diagram of the Corollary to conclude $cat((\Lambda V, d) \otimes \mathbb{K}) \leq m$. \square

Example 2 *Rational category of smooth manifolds.*

Let M be a simply connected smooth manifold with rational cohomology of finite type, and let $(\Lambda W, d) \rightarrow A_{DR}(M)$ be a minimal Sullivan model for the cochain algebra of C^∞ differential forms on M . We observe that

$$cat_0 M = cat(\Lambda W, d) .$$

In fact, as we saw in §11, $A_{DR}(M)$ is connected by quasi-isomorphisms of commutative cochain algebras to $A_{PL}(M; \mathbb{Q}) \otimes \mathbb{R}$. Thus if $(\Lambda V, d)$ is a rational minimal Sullivan model for M then $(\Lambda W, d) \cong (\Lambda V, d) \otimes \mathbb{R}$. It follows now from Example 1 (and Proposition 29.4) that $cat_0 M = cat_0(\Lambda V, d) = cat(\Lambda W, d)$. \square

(f) The model of $(\Lambda V, d) \rightarrow (\Lambda V/\Lambda^{>m} V, d)$.

Recall that Proposition 29.10 describes the structure of a Sullivan model $\zeta : (\Lambda V \otimes \Lambda Z, d) \xrightarrow{\simeq} (\Lambda V/\Lambda^{>m} V, d)$ of the surjection ρ , where $(\Lambda V, d)$ is a minimal Sullivan algebra and $V = \{V^i\}_{i \geq 2}$. Here we provide the proof, beginning with two preliminary steps.

Step 1 *The quadratic part of the differential.*

Let d_1 , be the quadratic part of the differential in ΛV . Construct a $(\Lambda V, d_1)$ -module, $(\Lambda V \otimes (\mathbb{k} \oplus M), d_1)$ by requiring that $d_1 : M^n \rightarrow \Lambda^{>m}V \oplus (\Lambda^+V \otimes M^{<n})$ and that

$$\alpha = H(d_1) : M^n \xrightarrow{\cong} H(\Lambda^{>m}V \oplus (\Lambda^+V \otimes M^{<n})) .$$

Since $V = \{V^i\}_{i \geq 2}$ any element of degree n in $\Lambda^{>m}V \oplus (\Lambda^+V \otimes M)$ has the form $\Phi = x + y + z$ with $z \in M^n$, $y \in \Lambda^+V \otimes M^{<n-1}$ and $x \in \Lambda^{>m}V$. If $d\Phi = 0$ then z is in the kernel of the map α above and so $z = 0$. Then $d(x + y) = 0$ and so by construction, $x + y$ is a coboundary in $\Lambda^{>m}V \oplus (\Lambda V \otimes M^{<n})$. It follows that $H(\Lambda^{>m}V \oplus (\Lambda V \otimes M), d_1) = 0$. In particular, a quasi-isomorphism of $(\Lambda V, d_1)$ -modules

$$\xi : (\Lambda V \otimes (\mathbb{k} \oplus M), d_1) \xrightarrow{\cong} (\Lambda V / \Lambda^{>m}V, d_1)$$

is defined by $\xi(1) = 1$ and $\xi(M) = 0$.

Bigrade ΛV by putting $(\Lambda V)^{p,*} = \Lambda^p V$. Then d_1 is homogeneous of bidegree $(1, 0)$. The inductive procedure above defines a bigradation in $M : M = \bigoplus_{p \geq m} M^{p,*}$ so that d_1 is homogeneous of bidegree $(1, 0)$ with respect to the induced bigradation in $\Lambda V \otimes (\mathbb{k} \oplus M)$, denoted by $[\Lambda V \otimes (\mathbb{k} \oplus M)]^{p,q}$. We call p the *filter degree*.

The key observation is that $M^{>m,*} = 0$; i.e.,

Lemma 29.11 $M = M^{m,*}$.

proof: As in the Example in §14(b) extend $(\Lambda V, d_1)$ to a minimal relative Sullivan algebra $(\Lambda V \otimes \Lambda \bar{V}, D)$ with $H(\Lambda V \otimes \Lambda \bar{V}, D) = \mathbb{k}$. As shown in that Example, $D : \bar{V} \rightarrow \Lambda^+V \otimes \Lambda \bar{V}$, and the linear part of D is an isomorphism $\bar{V} \xrightarrow{\cong} V$ of degree 1.

Filter $(\Lambda V \otimes \Lambda \bar{V}, D)$ by the ideals $\Lambda^{\geq p}V \otimes \Lambda \bar{V}$. In the resulting spectral sequence the differential in E_0 is zero and so the E_1 -term is a Sullivan algebra $(\Lambda V \otimes \Lambda \bar{V}, \delta)$ extending $(\Lambda V, d_1)$. As with D the linear part of δ is an isomorphism $\bar{V} \xrightarrow{\cong} V$. It follows that $(\Lambda V \otimes \Lambda \bar{V}, \delta)$ is contractible and hence $H(\Lambda V \otimes \Lambda \bar{V}, \delta) = \mathbb{k}$. Note that δ is homogeneous of bidegree $(1, 0)$ with respect to the bigradation $(\Lambda V \otimes \Lambda \bar{V})^{p,*} = \Lambda^p V \otimes \Lambda \bar{V}$.

Next recall (Proposition 6.7) that if (N, δ) is any semifree $(\Lambda V, d_1)$ -module then $- \otimes_{\Lambda V} N$ preserves quasi-isomorphisms. Thus we obtain quasi-isomorphisms

$$(\Lambda V / \Lambda^{>m}V \otimes \Lambda \bar{V}, \delta) \xleftarrow{\cong} [\Lambda V \otimes (\mathbb{k} \oplus M)] \otimes_{\Lambda V} [\Lambda V \otimes \Lambda \bar{V}] \rightarrow (\mathbb{k} \oplus M, 0) .$$

It follows that $\mathbb{k} \oplus M$ and $H(\Lambda V / \Lambda^{>m}V \otimes \Lambda \bar{V}, \delta)$ are isomorphic as bigraded spaces.

Finally, use the short exact sequence

$$0 \rightarrow (\Lambda^{>m}V \otimes \Lambda \bar{V}, \delta) \rightarrow (\Lambda V \otimes \Lambda \bar{V}, \delta) \rightarrow (\Lambda V / \Lambda^{>m}V \otimes \Lambda \bar{V}, \delta) \rightarrow 0$$

to obtain an isomorphism $H^+(\Lambda V/\Lambda^{>m}V \otimes \Lambda \bar{V}, \delta) \xrightarrow{\cong} H(\Lambda^{>m}V \otimes \Lambda \bar{V}, \delta)$ of bidegree $(1, 0)$. The source is concentrated in bidegrees $(p, *)$ with $p \leq m$ and the target in bidegrees $(q, *)$ with $q > m$. It follows that $H^+(\Lambda V/\Lambda^{>m}V \otimes \Lambda \bar{V}, \delta)$ is concentrated in bidegrees $(m, *)$. \square

Step 2 $A(\Lambda V, d)$ -semifree resolution for $(\Lambda V/\Lambda^{>m}V, d)$.

The differential d in ΛV satisfies: $(d - d_1) : (\Lambda V)^{p,*} \rightarrow (\Lambda V)^{\geq p+2,*}$, since $(\Lambda V)^{p,*}$ is just $\Lambda^p V$. We shall now extend $(\Lambda V, d)$ to a $(\Lambda V, d)$ -module $(\Lambda V \otimes (\mathbb{k} \oplus M), d)$ such that

$$d - d_1 : [\Lambda V \otimes (\mathbb{k} \oplus M)]^{p,*} \rightarrow [\Lambda V \otimes (\mathbb{k} \oplus M)]^{\geq p+2,*} .$$

For this it is sufficient to suppose d constructed in $M^{<n}$ and to extend it to M^n . Observe first that any d -cocycle z of degree $n+2$ in $[\Lambda V \otimes (\mathbb{k} \oplus M^{<n})]^{\geq m+3,*}$ is the d -coboundary of an element in $[\Lambda V \otimes (\mathbb{k} \oplus M^{<n})]^{\geq m+2,*}$. In fact, write $z = \sum_{i=r}^{n+2} x_i$, where x_i has filter degree r , some $r \geq m+3$. Then $dz = 0$ implies $d_1 x_r = 0$. Since $H(\Lambda V \otimes (\mathbb{k} \oplus M), d_1)$ is concentrated in filter degrees $\leq m$ it follows that $x_r = d_1 x'$ with x' of filter degree $r-1$. In particular, $x' \in (\Lambda^{\geq 2} V \otimes M)^{n+1} \oplus \Lambda V \subset \Lambda V \otimes (\mathbb{k} \oplus M^{<n})$. Now $z - dx' = \sum_{i=r+1}^{n+2} y_i$ with y_i of filter degree i . Continue in this way to obtain $z = du$ with $u \in [\Lambda V \otimes (\mathbb{k} \oplus M^{<n})]^{\geq m+2,*}$.

We now extend d to M^n as follows. If $w \in M^n$ then $d_1 w \in \Lambda V \otimes (\mathbb{k} \oplus M^{<n})$, because $V = \{V^i\}_{i \geq 2}$. Thus $dd_1 w$ is a d -cocycle of degree $n+2$ in $[\Lambda V \otimes (\mathbb{k} \oplus M^{<n})]^{\geq m+3,*}$, because $M = M^{m,*}$. This implies $dd_1 w = du$ for some $u \in [\Lambda V \otimes (\mathbb{k} \oplus M^{<n})]^{\geq m+2,*}$ as we observed just above. Extend d by setting $dw = d_1 w - u$ as w runs through a basis of M^n .

This completes the construction of $(\Lambda V \otimes (\mathbb{k} \oplus M), d)$. Since $d(M) \subset \Lambda^{>m}V \oplus (\Lambda V \otimes M)$ a morphism

$$\zeta : (\Lambda V \otimes (\mathbb{k} \oplus M), d) \rightarrow (\Lambda V/\Lambda^{>m}V, d)$$

of $(\Lambda V, d)$ -modules is defined by $\zeta \Big|_{\Lambda V} = \varrho$ and $\zeta(M) = 0$. (Thus if we forget differentials ζ coincides with the morphism ξ of Step 1). In particular filtering by $[\Lambda V \otimes (\mathbb{k} \oplus M)]^{\geq p,*}$ and by $\Lambda^{\geq p}V/(\Lambda^{>m}V)$, we obtain from ζ a morphism of spectral sequences which at the E_1 -term is just

$$E_1(\zeta) = \xi : (\Lambda V \otimes (\mathbb{k} \oplus M), d_1) \rightarrow (\Lambda V/\Lambda^{>m}V, d_1) .$$

Since ξ is a quasi-isomorphism so is ζ : ζ is a $(\Lambda V, d)$ semifree resolution of $(\Lambda V/\Lambda^{>m}V, d)$.

Finally, the same argument as used in the observation at the start of the construction of d gives

Lemma 29.12 *If $w \in [\Lambda V \otimes (\mathbb{k} \oplus M)]^{>r,*}$ is a d -cocycle and if $r \geq m$ then $w = du$ for some $u \in [\Lambda V \otimes (\mathbb{k} \oplus M)]^{\geq r,*}$. \square*

We now turn to the

proof of Proposition 29.10: Set $Z_0 = M$, so that the $(\Lambda V, d)$ -module of Step 2 is written $(\Lambda V \otimes (\mathbb{k} \oplus Z_0), d)$. Extend d and the quasi-isomorphism ζ of Step 2 (uniquely) to a morphism $\zeta : (\Lambda V \otimes \Lambda Z_0, d) \rightarrow (\Lambda V / \Lambda^{>m} V, d)$ of cochain algebras.

Next suppose by induction that this is extended to a morphism

$$\zeta : (\Lambda V \otimes \Lambda(Z_{<p} \oplus Z_p^{<n}), d) \rightarrow (\Lambda V / \Lambda^{>m} V, d)$$

of cochain algebras such that $\zeta(Z_{<p} \oplus Z_p^n) = 0$ and conditions (i) and (ii) of the Proposition are satisfied. Simplify notation by writing $W = Z_{<p} \oplus Z_p^{<n}$ and extend the quotient Sullivan algebra $(\Lambda W, \bar{d})$ to a quadratic Sullivan algebra $(\Lambda(W \oplus Z_p^n), \bar{d})$ by requiring that $d : Z_p^n \xrightarrow{\cong} (\Lambda^2 W)_{p-1}^{n+1} \wedge \ker \bar{d}$.

Let $z \in Z_p^n$. Then $d \bar{d}z = x + y$ with

$$x \in \bigoplus_{q < p} \Lambda^{>q(m-1)} V \otimes (\Lambda^2 W)_{p-q-1} \quad \text{and} \quad y \in \bigoplus_{q < p} \Lambda^{>m+q(m-1)} V \otimes W_{p-q-1} .$$

The component of $d(x + y)$ in $\Lambda V \otimes \Lambda^3 W$ is just $(id \otimes \bar{d})x$. Since $d(x + y) = 0$ so is $(id \otimes \bar{d})x = 0$. By (ii) of the Proposition, $x = (id \otimes \bar{d})x'$ for some $x' \in \bigoplus_{q < p} \Lambda^{>q(m-1)} V \otimes W_{p-q}$.

It follows that $\Phi = d(\bar{d}z - x')$ is a cocycle in $\Lambda V \otimes (\mathbb{k} \oplus W)$. Thus its component in $\Lambda V \otimes W$ is an $(id \otimes \bar{d})$ -cocycle. By (ii) of the Proposition this component is in $\Lambda V \otimes Z_0$. Thus a careful inspection shows that

$$\Phi \in \left(\Lambda^{>1+p(m-1)} V \otimes Z_0 \right) \oplus \Lambda^{>m+1+p(m-1)} V .$$

Apply Lemma 29.12 to conclude that $\Phi = d\Psi$ with $\Psi \in (\Lambda^{>p(m-1)} V \otimes Z_0) \oplus \Lambda^{>m+p(m-1)} V$. Extend d by setting $dz = \bar{d}z - x' - \Psi$ as z runs through a basis of Z_p^n . Extend ζ by setting $\zeta(Z_p^n) = 0$. This completes the inductive step and hence the construction of $(\Lambda V \otimes \Lambda Z, d)$ and of ζ .

To check that ζ is a quasi-isomorphism it is sufficient to establish (iii): the inclusion of $(\Lambda V \otimes (\mathbb{k} \oplus Z_0), d)$ in $(\Lambda V \otimes \Lambda Z, d)$ is a quasi-isomorphism, because the restriction of ζ to $(\Lambda V \otimes (\mathbb{k} \oplus Z_0), d)$ is a quasi-isomorphism (Step 2).

Filter both sides by the submodules $\Lambda^{\geq p} V \otimes -$ to obtain a morphism of spectral sequences with E_0 -term the inclusion $(\Lambda V \otimes (\mathbb{k} \oplus Z_0), 0) \rightarrow (\Lambda V \otimes \Lambda Z, id \otimes \bar{d})$. It is thus sufficient to show that $\mathbb{k} \oplus Z_0 \xrightarrow{\cong} (\Lambda Z, \bar{d})$. But in view of (ii) this is precisely the assertion in Example 7 of §12(d). \square

(g) **The Milnor-Moore spectral sequence and Ginsburg's theorem.**

Let $(\Lambda V, d)$ be a minimal Sullivan algebra with $V = \{V^i\}_{i \geq 2}$. Filtering by the ideals $F^p = \Lambda^{\geq p} V$ yields a spectral sequence, the *Milnor-Moore spectral sequence* for $(\Lambda V, d)$. This spectral sequence was introduced in §23(b) where it was shown that

$$\begin{aligned} (E_0, d_0) &= (\Lambda V, 0) \\ (E_1, d_1) &= (\Lambda V, d_1) \end{aligned}$$

and

$$E_2^{p,q} = [\text{Ext}_{UL}^p(\mathbb{k}, \mathbb{k})]^{p+q},$$

where L is the homotopy Lie algebra of $(\Lambda V, d)$. Moreover E_∞ is just the associated bigraded algebra of $H(\Lambda V, d)$:

$$E_\infty^{p,*} = F^p H(\Lambda V) / F^{p+1} H(\Lambda V),$$

where $F^p H(\Lambda V)$ is the image of $H(\Lambda^{\geq p} V, d)$ in $H(\Lambda V, d)$.

On the other hand, $e(\Lambda V, d)$ is the largest integer r such that the image of $H(\Lambda^{\geq r} V, d)$ in $H(\Lambda V, d)$ is non-zero. We restate this as

Proposition 29.13 *The Toomer invariant $e(\Lambda V, d)$ is the largest integer r such that $E_\infty^{r,*}(\Lambda V, d) \neq 0$. In particular,*

$$E_\infty^{p,*}(\Lambda V, d) = 0 \quad p > \text{cat}(\Lambda V, d).$$

Finally we establish the Sullivan algebra version of a theorem of Ginsburg [64], for which a simple proof was later given by Ganea [62].

Theorem 29.14 *Suppose $(\Lambda V, d)$ is a minimal Sullivan algebra and $V = \{V^i\}_{i \geq 2}$. If $\text{cat}(\Lambda V, d) = m$ then the Milnor-Moore spectral sequence collapses at some E_ℓ , $\ell \leq m + 1$; i.e. $E_{m+1} = E_\infty$.*

proof: Recall the $(\Lambda V, d)$ -semifree resolutions

$$\zeta(k) = (\Lambda V \otimes (\mathbb{k} \oplus M(k)), d) \xrightarrow{\cong} (\Lambda V / \Lambda^{>k} V, d)$$

constructed in Step 2 of §29(f). We denote $\Lambda V \otimes (\mathbb{k} \oplus M(k))$ simply by $Q(k)$. Recall that $Q(k)$ is bigraded with $\Lambda^p V = (\Lambda V)^{p,*}$ and $M(k) = M(k)^{k,*}$ (Lemma 29.11). Moreover, it follows from the construction that $d : Q(k)^{p,*} \rightarrow Q(k)^{\geq p+1,*}$.

Our first step is to construct a commutative diagram of $(\Lambda V, d)$ -modules of the form

$$\begin{array}{ccc} (Q(k+m), d) & \xrightarrow[\cong]{\zeta} & \Lambda V / \Lambda^{>m+k} V \\ \downarrow \varphi & & \downarrow e \\ (Q(m), d) & \xrightarrow[\zeta]{\cong} & \Lambda V / \Lambda^{>m} V \end{array}$$

such that $\varphi : Q(k + m)^{p,*} \rightarrow Q(m)^{\geq p,*}$ for all p and φ is the identity on ΛV . (Here $\varrho(1) = 1$!) For this it is sufficient to construct φ in $M(k + m)$ and we suppose by induction this is done in $M(k + m)^{<n}$.

Let $z \in M(k + m)^n$. Then $dz \in [\Lambda V \otimes (\mathbb{k} \oplus M(k + m)^{<n})]^{\geq k+m,*}$. Thus φdz is defined and $\varphi dz \in Q(m)^{\geq k+m,*}$. By Lemma 29.12 we may write $\varphi dz = du$ with $u \in Q(m)^{\geq k+m,*}$. Extend φ by setting $\varphi z = u$.

This completes the construction of φ . Since ζ and φ preserve filtrations $\zeta\varphi(M(k + m)) = 0 = \varrho\zeta(M(k + m))$ and thus the diagram commutes.

Now suppose $\text{cat}(\Lambda V, d) \leq m$. Then there is a morphism $\eta : (Q(m), d) \rightarrow (\Lambda V, d)$ of $(\Lambda V, d)$ -modules extending the identity on $(\Lambda V, d)$. In particular, $\eta : Q(m)^{p,*} \rightarrow \Lambda^{\geq p-m}V$. It follows that $\varrho(k)\varphi\eta$ vanishes in $M(k + m)$ and thus the diagram

$$\begin{array}{ccc} Q(m + k) & \xrightarrow{\varphi} & Q(m) \\ \varrho\zeta(m+k) \downarrow & & \downarrow \eta \\ \Lambda V / \Lambda^{\geq k}V & \xleftarrow{\varrho(k)} & \Lambda V \end{array}$$

commutes.

Finally let $z \in E_\ell^{k,*}$, some $\ell > m$. Then z is represented by an element $w \in \Lambda^{\geq k}V$ such that $dw \in \Lambda^{\geq k+\ell}V$. To show $d_\ell z = 0$ it is sufficient to find a cocycle $w' \in \Lambda^{\geq k}V$ such that $w - w' \in \Lambda^{\geq k}V$.

But since $dw \in \Lambda^{\geq k+m}V$, $\varrho(m + k)w$ is a cocycle in $\Lambda V / \Lambda^{\geq k+m}V$. Write $\varrho(m + k)w = \zeta(m + k)u$ for some cocycle $u \in Q(m + k)$. Then $\varrho(k)w = \varrho\varrho(m + k)w = \varrho\zeta(m + k)u = \varrho(k)\eta\varphi u$. Thus the cocycle $w' = \eta\varphi u$ has the desired properties, since $\varrho(k)w' = \varrho(k)w$.

This shows $d_\ell = 0$, $\ell \geq m + 1$ and so $E_\infty = E_{m+1}$. □

(h) The invariants mcat and e for $(\Lambda V, d)$ -modules.

Fix a minimal Sullivan algebra $(\Lambda V, d)$. This topic relies heavily on §6, often without explicit reference. In particular morphism means morphism of $(\Lambda V, d)$ -module and homotopy is the relation defined at the start of §6(a). For any $(\Lambda V, d)$ -module, (M, d) , we may then make the following constructions:

- a semifree resolution $(P, d) \xrightarrow{\cong} (M, d)$.
- the surjections $\varrho(k) : (P, d) \rightarrow (P / \Lambda^{\geq k}V \cdot P, d)$.
- homotopy commutative diagrams of $(\Lambda V, d)$ -module morphisms,

$$\begin{array}{ccc} (P, d) & \xrightarrow{\lambda(k)} & (P(k), d) \\ & \searrow \varrho(k) & \downarrow \simeq \zeta(k) \\ & & (P / \Lambda^{\geq k}V \cdot P, d) \end{array} ,$$

where $\zeta(k)$ is a semifree resolution of $(P / \Lambda^{\geq k}V \cdot P, d)$.

These constructions are unique ‘up to quasi-isomorphism’. Indeed, if $(Q, d) \xrightarrow{\cong} (M, d)$ is a second $(\Lambda V, d)$ -semifree resolution then there is a quasi-isomorphism $\alpha : (Q, d) \xrightarrow{\cong} (P, d)$ of $(\Lambda V, d)$ -modules. Moreover

$$id \otimes_{\Lambda V} \alpha : \Lambda V / \Lambda^{>k} V \otimes_{\Lambda V} Q \rightarrow \Lambda V / \Lambda^{>k} V \otimes_{\Lambda V} P$$

is also a quasi-isomorphism, and this is just the quotient map $\alpha(k) : Q / \Lambda^{>k} V \cdot Q \rightarrow P / \Lambda^{>k} V \cdot P$. Thus $\alpha(k)$ lifts to a quasi-isomorphism $\beta(k) : (Q(k), d) \rightarrow (P(k), d)$ such that $\zeta(k)\beta(k) \sim \alpha(k)\zeta(k)$. Automatically then $\lambda(k)\alpha \sim \beta(k)\lambda(k)$. In particular, the following definition is independent of the choice of semifree resolution and constructions above:

Definition (i) The *module category* of (M, d) , $mcat(M, d)$, is the least integer m for which there is a morphism $\eta : (P(m), d) \rightarrow P(d)$ such that $\eta\lambda(m) \sim id$.

(ii) The *Toomer invariant* of (M, d) , $e(M, d)$, is the least integer r such that $H(\varrho(r))$ is injective.

Proposition 29.15 For a minimal Sullivan algebra $(\Lambda V, d)$ and any $(\Lambda V, d)$ -module, (M, d) :

- (i) $e(M, d) \leq mcat(M, d)$.
- (ii) $mcat(M, d) \leq mcat(\Lambda V, d)$.
- (iii) If $V = \{V^i\}_{i \geq 2}$ then $mcat(\Lambda V, d) = cat(\Lambda V, d)$.

proof: (i) This is immediate from the definitions.

(ii) Suppose $mcat(\Lambda V, d) = k$ and construct a homotopy commutative diagram

$$\begin{array}{ccc} (\Lambda V, d) & \xrightarrow{\lambda} & (N, d) \\ & \searrow e & \downarrow \simeq \zeta \\ & & (\Lambda V / \Lambda^{>k} V, d) \end{array}$$

and a morphism $\eta : (N, d) \rightarrow (\Lambda V, d)$, such that ζ is a semifree resolution and $\eta\lambda \sim id$. Let (P, d) be a semifree resolution for (M, d) , and apply $- \otimes_{\Lambda V} P$ to this diagram. This yields

$$\begin{array}{ccccc} (P, d) & \xrightarrow{\lambda'} & (N \otimes_{\Lambda V} P, d) & \xrightarrow{\eta'} & (P, d) \\ & \searrow e' & \downarrow \simeq \zeta' & & \\ & & (P / \Lambda^{>k} V \cdot P, d) & & \end{array}$$

with $\eta'\lambda' \sim id$. It follows that $mcat(M, d) \leq k$.

(iii) Let $\zeta : (\Lambda V \otimes \Lambda Z, d) \rightarrow (\Lambda V / \Lambda^{>m} V, d)$ be a minimal Sullivan model for the surjection ρ . It is in particular a $(\Lambda V, d)$ -semifree resolution. If $\text{cat}(\Lambda V, d) = m$ there is a morphism $\eta : (\Lambda V \otimes \Lambda Z, d) \rightarrow (\Lambda V, d)$ of Sullivan algebras restricting to the identity in $(\Lambda V, d)$. In particular, η is ΛV -linear and so $\text{mcat}(\Lambda V, d) \leq m$.

Conversely, if $\text{mcat}(\Lambda V, d) = m$ then there is a morphism $\eta : (\Lambda V \otimes \Lambda Z, d) \rightarrow (\Lambda V, d)$ of $(\Lambda V, d)$ -modules such that $\eta\lambda \sim id$, λ denoting the obvious inclusion. But this implies $H(\eta\lambda) = id$ and so $\eta\lambda(1) = 1$. Since $\eta\lambda$ is ΛV -linear, $\eta\lambda = id$. Now Hess' theorem 29.9 asserts that $\text{cat}(\Lambda V, d) \leq m$. \square

Finally, suppose (M, d) is a $(\Lambda V, d)$ -module. The dual $(\Lambda V, d)$ -module, $\text{Hom}(M, \mathbb{k})$, of \mathbb{k} -linear functions is defined by

$$df = -(-1)^{\deg f} f \circ d \quad \text{and} \quad (\Phi \cdot f)(x) = (-1)^{\deg \Phi \deg f} f(\Phi x) ,$$

for $f \in \text{Hom}(M, \mathbb{k})$, $\Phi \in \Lambda V$ and $x \in M$.

Theorem 29.16 [55] *Let $(\Lambda V, d)$ be a minimal Sullivan algebra such that $V = \{V^i\}_{i \geq 2}$ and has finite type. Then*

$$\text{cat}(\Lambda V, d) = e(\text{Hom}(\Lambda V, \mathbb{k}), d) .$$

Lemma 29.17 *If a quasi-isomorphism $\alpha : (Q, d) \xrightarrow{\sim} (N, d)$ of $(\Lambda V, d)$ -modules factors as $(Q, d) \rightarrow (N', d) \rightarrow (N, d)$, with $\Lambda^{>r} V \cdot N' = 0$, then*

$$\text{mcat}(Q, d) \leq r .$$

proof: We lose no generality in assuring (Q, d) semifree. It follows from our hypotheses that α factors as $(Q, d) \xrightarrow{\rho(r)} (Q / \Lambda^{>r} V \cdot Q, d) \xrightarrow{\beta} (N, d)$. This yields a homotopy commutative diagram

$$\begin{array}{ccccc} (Q, d) & \xrightarrow{\lambda} & (Q(r), d) & \xrightarrow{\eta} & (Q, d) \\ & \searrow \rho(r) & \downarrow \simeq \zeta(r) & & \downarrow \simeq \alpha \\ & & (Q / \Lambda^{>r} V \cdot Q, d) & \xrightarrow{\beta} & (N, d) \end{array}$$

in which $\zeta(r)$ is a semifree resolution. Since $\alpha\eta\lambda \sim \beta\rho(r) = \alpha$ and α is a quasi-isomorphism it follows that $\eta\lambda \sim id$. Thus $\text{mcat}(Q, d) \leq r$. \square

proof of Theorem 29.16: Denote $(\text{Hom}(\Lambda V, \mathbb{k}), d)$ by (M, d) . The finite type restriction implies that $(\Lambda V, d) = (\text{Hom}(M, \mathbb{k}), d)$. Since $\text{cat}(\Lambda V, d) = \text{mcat}(\Lambda V, d) \geq e(M, d)$ — Proposition 29.15 — we have only to show that

$$e(M, d) > \text{mcat}(\Lambda V, d) .$$

Let $\varphi : (P, d) \xrightarrow{\cong} (M, d)$ be a semifree resolution. Since $(\text{Hom}(M, \mathbb{k}), d) = (\Lambda V, d)$ this dualizes to a semifree resolution $\text{Hom}(\varphi, \mathbb{k}) : (\Lambda V, d) \xrightarrow{\cong} \text{Hom}(P, \mathbb{k})$. Let $z = \text{Hom}(\varphi, \mathbb{k})1 \in \text{Hom}(P, \mathbb{k})$.

Now suppose $e(M, d) = r$. Then the surjection $\varrho : (P, d) \rightarrow (P/\Lambda^{>r}V \cdot P, d)$ is injective in homology. It follows that the dual, $\text{Hom}(\varrho, \mathbb{k})$, induces a surjection

$$H(\text{Hom}(P/\Lambda^{>r}V \cdot P, \mathbb{k})) \longrightarrow H(\text{Hom}(P, \mathbb{k})) .$$

In particular there is a cocycle $f \in \text{Hom}(P/\Lambda^{>r}V \cdot P, \mathbb{k})$ such that $[f \circ \varrho] = [z]$.

The quasi-isomorphism $\Lambda V \xrightarrow{\cong} \text{Hom}(P, \mathbb{k})$ is given by $\Phi \mapsto \Phi \cdot z$. Thus it factors as

$$(\Lambda V, d) \xrightarrow{\alpha} (\text{Hom}(P/\Lambda^{>r}V \cdot P, \mathbb{k}), d) \xrightarrow{\text{Hom}(\varrho, \mathbb{k})} (\text{Hom}(P, \mathbb{k}), d)$$

where $\alpha\Phi = \Phi \cdot f$. Now for any $g \in \text{Hom}(P/\Lambda^{>r}V \cdot P, \mathbb{k})$, $x \in P/\Lambda^{>r}V \cdot P$ and $\Psi \in \Lambda^{>r}V$ we have $(\Psi \cdot g)(x) = \pm g(\Psi \cdot x) = 0$. Thus $\Lambda^{>r}V \cdot \text{Hom}(P/\Lambda^{>r}V \cdot P, \mathbb{k}) = 0$ and Lemma 29.17 implies that $\text{mcat}(\Lambda V, d) \leq r$. □

Corollary *Let X be a simply connected topological space with rational homology of finite type, and rational minimal Sullivan algebra $(\Lambda V, d)$. Then*

$$\text{cat}_0 X = e(\text{Hom}(\Lambda V, \mathbb{Q}), d) .$$

proof: Apply Proposition 29.4. □

Exercises

1. Suppose that the homogeneous space $M = Sp(5)/SU(5)$ admits a minimal model of the form $(\wedge(a, b, x, y, z), d)$ with $\deg a = 6$, $\deg b = 10$, $\deg x = 11$, $\deg y = 15$, $\deg z = 19$, $da = db = 0$, $dx = a^2$, $dy = ab$ and $dz = b^2$. Compute $\text{cat}_0 M$.
2. Let Y be a coformal space and $X = Y \cup_{\varphi} e^n$. Supposing $\text{cat} Y = n > 1$. Prove that $\text{cat} X \leq \text{cat} Y$.
3. Using 24.5, 24.7 and 29.5, prove that any sub Lie algebra of a free graded Lie algebra is free.
4. Let $X = (\mathbb{C}P^2 \vee S^2)$. Denote by α , β and γ generators, respectively, of $\pi_5(\mathbb{C}P^2)$, $\pi_2(S^2)$ and $\pi_2(\mathbb{C}P^2)$. Consider the spaces $Y = X \cup_{[\alpha, \beta]} e^7$ and $Z = \mathbb{C}P^2 \times S^3$. Using minimal models prove that the map $f : \mathbb{C}P^2 \vee S^3 \rightarrow Y$ which restricts to the identity on $\mathbb{C}P^2$ and represents the class $[\beta, \gamma]$ when restricted to S^3 , extends, once localized, to a continuous map $f : Z_0 \rightarrow Y_0$ such that $\pi_* f$ is injective. Prove that $\text{cat}_0 Y = 3$. Deduce that there is no mapping theorem for the invariants e_0 and for the rational cup length.

30 Rational LS category of products and fibrations

In this section the ground ring is an arbitrary field \mathbb{k} of characteristic zero.

Lusternik-Schnirelmann category is not well-behaved on products and fibrations. For example, a simple argument shows that for topological spaces Y and Z ,

$$\max(\text{cat } Y, \text{cat } Z) \leq \text{cat}(Y \times Z) \leq \text{cat } Y + \text{cat } Z ,$$

and inequalities are sharp: for each one there is a non-trivial example where the inequality is an equality. For general fibrations $p : X \rightarrow Y$ with fibre F , moreover, the best that can be asserted is

$$0 \leq \text{cat } X \leq (\text{cat } Y + 1)(\text{cat } F + 1) - 1 .$$

This section analyzes the behaviour of the rational category of products and fibrations. For products cat_0 behaves well: we establish the recent result with Lemaire [55]: *Y and Z are simply connected with rational homology of finite type then*

$$\text{cat}_0(Y \times Z) = \text{cat}_0 Y + \text{cat}_0 Z .$$

(The case $Z = S^n$ had been established earlier by Hess [90] and Jessup [98].)

In the case of fibrations of simply connected spaces with rational homology of finite type, the inequalities above remain sharp if cat is replaced by cat_0 . With reasonable assumptions, however, they can be improved. For example, if F is an odd sphere then

$$\text{cat}_0 X \leq \text{cat}_0 Y + 1 ,$$

while if $\text{cat}_0 F < \infty$ then

$$\text{cat}_0 X \geq \text{cat}_0 F - \dim \partial_* (\pi_{\text{even}}(Y) \otimes \mathbb{Q}) ,$$

$\partial_* \otimes \mathbb{Q} : \pi_*(Y) \otimes \mathbb{Q} \rightarrow \pi_{*-1}(F) \otimes \mathbb{Q}$ denoting the connecting homomorphism. Finally, we strengthen the Mapping theorems 28.6 and 29.5 for the special case of a fibre inclusion.

This section is organized into the following topics:

- (a) Rational LS category of products.
- (b) Rational LS category of fibrations.
- (c) The mapping theorem for a fibre inclusion.

(a) Rational LS category of products.

We begin with the classical

Proposition 30.1 *If Y and Z are normal topological spaces then*

$$\max(\text{cat } Y, \text{cat } Z) \leq \text{cat}(Y \times Z) \leq \text{cat } Y + \text{cat } Z .$$

proof: The first inequality follows from the fact that Y and Z are retracts of $Y \times Z$ (Lemma 27.1). For the second, suppose $\text{cat } Y = m$ and $\text{cat } Z = n$. Then Y and Z are respectively retracts of an m -cone P' and an n -cone Q' (Theorem 27.10). We may write $P' \simeq P = \{p_0\} \subset P_1 \subset \dots \subset P_m$ with $P_{k+1} = P_k \cup_{f_k} CA_k$, and $Q' \simeq Q = \{q_0\} \subset Q_1 \subset \dots \subset Q_n$ with $Q_{\ell+1} = Q_\ell \cup_{g_\ell} CB_\ell$. It is clearly sufficient to prove $\text{cat}(P \times Q) \leq m + n$.

Set $(P \times Q)_r = \bigcup_{k+\ell=r} P_k \times Q_\ell$. Then $(P \times Q)_r - (P \times Q)_{r-1}$ is the disjoint union of the contractible open subsets $(P_k - P_{k-1}) \times (Q_{r-k} - Q_{r-k-1})$ of $(P \times Q)_r$; thus it is contractible in $(P \times Q)_r$. Let $p_k \in P_k - P_{k-1}$ and $q_\ell \in Q_\ell - Q_{\ell-1}$ be the vertices of the cones CA_k and CB_ℓ and set $U = (P \times Q)_r - \prod_{k=0}^r (p_k, q_{r-k})$. Since $(P \times Q)_r = ((P \times Q)_r - (P \times Q)_{r-1}) \cup U$ it follows that $\text{cat}(P \times Q)_r \leq \text{cat } U + 1$. On the other hand, U deformation retracts onto $(P \times Q)_{r-1}$ with deformation $H : U \times I \rightarrow U$ given explicitly as follows: If $(p, q) \in (P \times Q)_{r-1}$ then $H(p, q, t) = (p, q)$. If $p = (a, s) \in CA_k$ and $q = (b, s') \in CB_{r-k}$ then $s + s' > 0$ and we set

$$H(p, q, t) = \begin{cases} ((a, s(1 + t - \frac{t}{s})), (b, s'(1 + t - \frac{t}{s}))) & , \quad s' \leq s \\ ((a, s(1 + t - \frac{t}{s'})), (b, s'(1 + t - \frac{t}{s'}))) & , \quad s' \geq s . \end{cases}$$

Thus $U \simeq (P \times Q)_{r-1}$ and $\text{cat } U = \text{cat}(P \times Q)_{r-1}$. Now we have $\text{cat}(P \times Q)_r \leq \text{cat}(P \times Q)_{r-1} + 1$ and hence $\text{cat}(P \times Q) \leq n + m$. □

The following classical example shows that the inequality of Proposition 30.1 can be strict. Fix a prime p and let $M^n(p) = S^n \cup_{f_n} CS^n$ where $f_n : S^n \rightarrow S^n$ induces multiplication by p in homology. Clearly we may take f_{n+1} to be the suspension Σf_n of f_n and so $M^{n+1}(p) \simeq \Sigma M^n(p)$. In particular, $\text{cat } M^n(p) = 1$, $n \geq 2$.

Now if q is a second, different prime the inclusion $i : M^m(p) \vee M^n(q) \rightarrow M^m(p) \times M^n(q)$ induces a homology isomorphism (easy calculation). Thus the Whitehead-Serre theorem 8.6 asserts that i is a weak homotopy equivalence. But these spaces are CW complexes and so i is a homotopy equivalence (Corollary 1.7). Thus

$$\text{cat}(M^m(p) \times M^n(q)) = \text{cat}(M^m(p) \vee M^n(q)) = 1 .$$

Recently, Iwase [95] has constructed a 2-cell complex Y such that

$$\text{cat}(Y \times S^n) = \text{cat } Y = 2 ,$$

thereby providing a considerably more dramatic example. Rationally, however, we have

Theorem 30.2 [55]

(i) *If Y and Z are simply connected topological spaces with rational homology of finite type then*

$$\text{cat}_0(Y \times Z) = \text{cat}_0 Y + \text{cat}_0 Z .$$

(ii) *If $(\Lambda V, d)$ and $(\Lambda W, d)$ are minimal Sullivan algebras with $V = \{V^i\}_{i \geq 2}$ and $W = \{W^i\}_{i \geq 2}$ graded vector spaces of finite type then*

$$\text{cat}((\Lambda V, d) \otimes (\Lambda W, d)) = \text{cat}(\Lambda V, d) + \text{cat}(\Lambda W, d) .$$

proof: The category of the rational Sullivan minimal models for Y , Z and $Y \times Z$ is just the rational LS category of Y , Z and $Y \times Z$ (Proposition 29.4). Moreover the models for Y and Z satisfy the conditions of (ii) (Proposition 12.2) and their tensor product is the model for $Y \times Z$ (Example 2, §12(a)). Thus (i) follows from (ii) when $\mathbb{k} = \mathbb{Q}$.

For (ii) we first let (M, d) and (N, d) be respectively any $(\Lambda V, d)$ -module and any $(\Lambda W, d)$ -module and notice that $(M, d) \otimes (N, d)$ is a $(\Lambda V, d) \otimes (\Lambda W, d)$ in the obvious way: $(\Phi \otimes \Psi) \cdot (m \otimes n) = (-1)^{\deg \Psi \deg m} \Phi \cdot m \otimes \Psi \cdot n$. We show that

$$e((M, d) \otimes (N, d)) = e(M, d) + e(N, d) ; \tag{30.3}$$

the theorem then follows from Theorem 29.16 which asserts that $\text{cat}(-) = e(\text{Hom}(-, \mathbb{k}))$ for Sullivan algebras satisfying the hypotheses above.

It remain to prove (30.3). We may suppose (M, d) and (N, d) are respectively $(\Lambda V, d)$ - and $(\Lambda W, d)$ -semifree; in this case the tensor product is obviously $(\Lambda V, d) \otimes (\Lambda W, d)$ -semifree. If $e(M, d) = m$ and $e(N, d) = n$ then the surjection $\pi : (M, d) \otimes (N, d) \rightarrow (M/\Lambda^{>m}V \cdot M, d) \otimes (N/\Lambda^{>n}W \cdot N, d)$ is injective in cohomology. Since $\ker \pi \supset \Lambda^{>m+n}(V \oplus W) \cdot (M \otimes N)$ it follows that $e((M, d) \otimes (N, d)) \leq m + n$. On the other hand, if $u \in \Lambda^{\geq m}V \cdot M$ and $z \in \Lambda^{\geq n}W \cdot N$ are cocycles representing non-trivial cohomology classes in $H(M)$ and $H(N)$ then $u \otimes z \in \Lambda^{\geq m+n}(V \oplus W) \cdot (M \otimes N)$ represents a non-trivial cohomology class, so $e((M, d) \otimes (N, d)) \geq m + n$. \square

(b) Rational LS category of fibrations.

In this topic we consider both topological spaces and Sullivan algebras. Thus

$$X \xrightarrow{p} Y \tag{30.4}$$

will always denote a fibration with fibre F in which X , Y and F are simply connected. Similarly,

$$(\Lambda V, d) \rightarrow (\Lambda V \otimes \Lambda W, d) \tag{30.5}$$

will always denote a minimal relative Sullivan algebra in which $(\Lambda V, d)$ is itself a minimal Sullivan algebra and V and W are concentrated in degrees ≥ 2 . We

recall from Theorem 15.3 that if $k = \mathbb{Q}$ and (30.5) is a Sullivan model for (30.4) then the Sullivan fibre $(\Lambda W, \bar{d})$ is a Sullivan model for F and that the connecting homomorphism $\partial_* \otimes \mathbb{Q} : \pi_*(Y) \otimes \mathbb{Q} \rightarrow \pi_{*-1}(F) \otimes \mathbb{Q}$ is dual up to sign to the linear part of the differential $d_0 : W \rightarrow V$ (Proposition 15.13). Finally, in this case Proposition 29.4 asserts that $\text{cat}(\Lambda V, d) = \text{cat}_0 Y$, $\text{cat}(\Lambda V \otimes \Lambda W, d) = \text{cat}_0 X$ and $\text{cat}(\Lambda W, \bar{d}) = \text{cat}_0 F$. *These results and notation will be used without further reference throughout this topic.*

Example 1 *The relative Sullivan algebra $(\Lambda(x, y), dy = x^{r+1}) \rightarrow (\Lambda(x, y, u, v), dy = x^{r+1}, dv = u^{n+1} - x)$.*

In this example we take x and u to be cocycles respectively of degrees $2(n+1)$ and 2. The quasi-isomorphism $\Lambda(x, y) \rightarrow (\Lambda x/x^{r+1}, d)$ shows that $H(\Lambda(x, y), d)$ is a commutative model for $(\Lambda(x, y), d)$. Thus (Corollary to Proposition 29.3) $\text{cat}(\Lambda(x, y), d) = \text{nil}(\Lambda x/x^{r+1}) = r$. Similarly $(\Lambda(u, v), \bar{d}) \xrightarrow{\cong} \Lambda u/u^{n+1}$ and $(\Lambda(x, y, u, v), d) \xrightarrow{\cong} (\Lambda u/u^{(r+1)(n+1)}, 0)$. Thus

$$\begin{aligned} \text{cat}(\Lambda(x, y, u, v), d) &= (n+1)(r+1) - 1 \\ &= (\text{cat}(\Lambda(x, y), d) + 1)(\text{cat}(\Lambda(u, v), \bar{d}) + 1) - 1. \quad \square \end{aligned}$$

Proposition 30.6 *The fibration $p : X \rightarrow Y$ (30.4) satisfies*

$$\text{cat } X \leq (\text{cat } Y + 1)(\text{cat } F + 1) - 1$$

and this inequality is best possible, even for rational spaces.

proof: Let $\text{cat } Y = m$ so that Y is the union of $m+1$ open sets U_α each contractible in X . The inclusion λ_α of $p^{-1}(U_\alpha)$ in X is then homotopic to a map $p^{-1}(U_\alpha) \rightarrow F \xrightarrow{j} X$ and it follows that $\text{cat } \lambda_\alpha \leq \text{cat } j \leq \text{cat } F$ (Lemma 27.1). Thus $p^{-1}(U_\alpha)$ is the union of $(n+1)$ open sets each contractible in X , and so $\text{cat } X + 1 \leq (\text{cat } Y + 1)(\text{cat } F + 1)$.

To see that this inequality can be sharp recall from Proposition 17.9 that spatial realization $| \cdot |$ converts a relative Sullivan algebra to a Serre fibration. Thus in Example 1, $|\Lambda(x, y, z, u, v), d| \rightarrow |\Lambda(x, y), d|$ is a Serre fibration with fibre $|\Lambda(u, v), \bar{d}|$. Denote $|\Lambda(x, y), d|$ by Y and convert this to a fibration $X \rightarrow Y$ with $X \simeq |\Lambda(x, y, u, v), d|$ and fibre $F \simeq |\Lambda(u, v), \bar{d}|$. Now by the Corollary to Proposition 29.4 the LS category of the realization is the category of the model. Thus Example 1 translates to

$$\text{cat } X = (r+1)(n+1) - 1 = (\text{cat } Y + 1)(\text{cat } F + 1) - 1. \quad \square$$

Under reasonable hypotheses it is possible to improve considerably on Proposition 30.6 for rational LS category. First we have

Proposition 30.7

(i) If $\dim W$ is finite and W is concentrated in odd degrees then

$$\text{cat}(\Lambda V \otimes \Lambda W, d) \leq \text{cat}(\Lambda V, d) + \dim W = \text{cat}(\Lambda V, d) + \text{cat}(\Lambda W, \bar{d}) .$$

(ii) If $\pi_*(F) \otimes \mathbb{Q}$ is finite dimensional and concentrated in odd degrees and if Y has rational homology of finite type then

$$\text{cat}_0 X \leq \text{cat}_0 Y + \dim \pi_*(F) \otimes \mathbb{Q} = \text{cat}_0 Y + \text{cat}_0 F .$$

proof: (i) The inequality is just the Mapping theorem 29.5(ii) applied to the inclusion $(\Lambda V, d) \rightarrow (\Lambda V \otimes \Lambda W, d)$. The equality $\dim W = \text{cat}(\Lambda W, \bar{d})$ is Example 6, §29(b).

(ii) is an immediate translation of (i). □

Proposition 30.8 (*Jessup [98]*)

(i) If $H(\Lambda V \otimes \Lambda W, d) \xrightarrow{H(\pi)} H(\Lambda W, \bar{d})$ is surjective then

$$\text{cat}(\Lambda V \otimes \Lambda W, d) \geq \text{cat}(\Lambda V, d) + \text{nil } H(\Lambda W, d) .$$

(ii) If $H^*(X; \mathbb{Q}) \rightarrow H^*(F; \mathbb{Q})$ is surjective and if Y and F have rational homology of finite type then

$$\text{cat}_0 X \geq \text{cat}_0 Y + c_0 F .$$

proof: Put $H = H(\Lambda W, \bar{d})$ and choose a linear map $\sigma : (H, 0) \rightarrow (\Lambda V \otimes \Lambda W, d)$ such that $H(\pi)H(\sigma) = \text{id}$. Then σ extends to a morphism $\text{id} \cdot \sigma : (\Lambda V, d) \otimes (H, 0) \rightarrow (\Lambda V \otimes \Lambda W, d)$ of $(\Lambda V, d)$ -modules. It preserves the filtrations $(\Lambda V)^{\geq p} \otimes H$ and $(\Lambda V)^{\geq p} \otimes \Lambda W$ and the resulting morphism of spectral sequences is an isomorphism of E_2 -terms. Thus $\text{id} \cdot \sigma$ is a quasi-isomorphism. It follows that there is also a quasi-isomorphism $\mu : (\Lambda V \otimes \Lambda W, d) \rightarrow (\Lambda V \otimes H, d)$ of $(\Lambda V, d)$ -modules because $(\Lambda V \otimes \Lambda W, d)$ is also $(\Lambda V, d)$ -semifree.

Suppose $\text{nil } H(\Lambda W, \bar{d}) = r$ and let $\bar{\omega} \in H$ be the product of r cohomology classes in H^+ . Each of these is the image of a cohomology class in $H^+(\Lambda V \otimes \Lambda W, d)$. The product of representing cocycles is thus a cocycle $\omega \in \Lambda V \otimes \Lambda W$ such that $\mu\omega - 1 \otimes \bar{\omega} \in \Lambda^+ V \otimes H^{< \deg \omega}$. Now define ΛV -linear maps

$$\alpha : (\Lambda V, d) \rightarrow (\Lambda V \otimes \Lambda W, d) \quad \text{and} \quad (\text{id} \otimes f) : (\Lambda V, d) \otimes H \rightarrow (\Lambda V, d)$$

by setting $\alpha(\Phi) = \Phi \cdot \omega$ and requiring $f(\bar{\omega}) = 1$. Then $(\text{id} \otimes f)\mu\omega = 1$ and hence

$$(\text{id} \otimes f) \circ \mu \circ \alpha = \text{id}_{\Lambda V} .$$

On the other hand, write $\Lambda V \otimes \Lambda W = \Lambda Z$, with $Z = V \oplus W$. Since ω is the product of r cocycles of positive degree, $\omega \in \Lambda^{\geq r} Z$. Thus for any m , α induces a morphism $\bar{\alpha} : (\Lambda V / \Lambda^{> m} V, d) \rightarrow (\Lambda Z / \Lambda^{> m+r} Z, d)$. This leads to the diagram

$$\begin{array}{ccc}
 (\Lambda V, d) & \xrightarrow{\lambda_V} & (P_V, d) \\
 \downarrow \alpha & \searrow \varrho_V & \swarrow \zeta_V \\
 & (\Lambda V / \Lambda^{> m} V, d) & \\
 & \downarrow \bar{\alpha} & \\
 & (\Lambda Z / \Lambda^{> m+r} Z, d) & \\
 & \swarrow \zeta_Z & \searrow \varrho_Z \\
 (\Lambda Z, d) & \xrightarrow{\lambda_Z} & (P_Z, d)
 \end{array}$$

in which ζ_V and ζ_Z are respectively $(\Lambda V, d)$ - and $(\Lambda Z, d)$ -semifree resolutions and λ_V, λ_Z and β are respectively ‘homotopy lifts’ of ϱ_V, ϱ_Z and $\bar{\alpha}\zeta_V$. Thus $\zeta_Z\beta\lambda_V \sim \zeta_Z\lambda_Z\alpha$ as $(\Lambda V, d)$ -linear maps; since ζ_Z is a quasi-isomorphism, $\beta\lambda_V \sim \lambda_Z\alpha$ (Proposition 6.4(i)).

Finally, observe that since $[\omega]$ maps to the non zero cohomology class $\bar{\omega}$, $[\omega] \neq 0$ and $\text{cat}(\Lambda Z, d) \geq e(\Lambda Z, d) \geq r$. Suppose $\text{cat}(\Lambda Z, d) = m + r$. Then there is a morphism $\eta : (P_Z, d) \rightarrow (\Lambda Z, d)$ of $(\Lambda Z, d)$ -modules such that $\eta\lambda_Z = id$. Set $\varphi = (id \otimes f)\mu\eta\beta : (P_V, d) \rightarrow (\Lambda V, d)$. Then in the diagram

$$\begin{array}{ccccc}
 (\Lambda V, d) & \xrightarrow{\lambda_V} & (P_V, d) & \xrightarrow{\varphi} & (\Lambda V, d) \\
 & & \downarrow \cong & & \\
 & & (\Lambda V / \Lambda^{> m} V, d) & &
 \end{array}$$

we have $\varphi\lambda_V = (id \otimes f)\mu\eta\beta\lambda_V \sim (id \otimes f)\mu\eta\lambda_Z\alpha = (id \otimes f)\mu\alpha = id_{\Lambda V}$. Thus the Corollary to Theorem 29.9 asserts that $\text{cat}(\Lambda V, d) \leq m$, i.e. $\text{cat}(\Lambda Z, d) \geq \text{cat}(\Lambda V, d) + \text{nil } H(\Lambda W, \bar{d})$.

This establishes (i), and (ii) is an immediate translation. □

(c) The mapping theorem for a fibre inclusion.

In the case of a fibre inclusion the Mapping theorems 28.6 and 29.5 can be strengthened as follows.

Proposition 30.9

(i) If $\text{cat}(\Lambda W, \bar{d}) < \infty$ then $d_0 = 0$ in W^{even} . Conversely, if $d_0 = 0$ in W^{even} , then

$$\dim \text{Im } d_0 \leq \text{cat}(\Lambda W, \bar{d}) \leq \text{cat}(\Lambda V \otimes \Lambda W, d) + \dim \text{Im } d_0 .$$

(ii) Suppose Y and F have rational homology of finite type. If $\text{cat}_0 F < \infty$ then $\partial_* \otimes \mathbb{Q} = 0$ in $\pi_{\text{odd}}(Y) \otimes \mathbb{Q}$. Conversely, if $\partial_* \otimes \mathbb{Q} = 0$ in $\pi_{\text{odd}}(Y) \otimes \mathbb{Q}$, then

$$\dim \text{Im}(\partial_* \otimes \mathbb{Q}) \leq \text{cat}_0 F \leq \dim \text{Im}(\partial_* \otimes \mathbb{Q}) + \text{cat}_0 X .$$

proof: Divide $(\Lambda V \otimes \Lambda W, d)$ by $\Lambda^{\geq 2} V \otimes W$ to obtain a quotient cochain algebra $((\mathbb{k} \otimes V) \otimes \Lambda W, \delta)$. If $\{v_i\}$ is a basis of V then $\delta = id \otimes \bar{d} + \sum v_i \otimes \theta_i$ and the θ_i are derivations of $(\Lambda W, \bar{d})$. Thus if $n_i = \deg \theta_i$ then θ_i restricts to a Gottlieb element $f_i : W^{n_i} \rightarrow \mathbb{k}$. Now suppose $d_0 w_i = v_i$, $1 \leq i \leq r$. Then $f_i(w_i) = 1$ and $f_j(w_i) = 0$, $j \neq i$. Thus Proposition 29.8 (ii) asserts that if $\text{cat}(\Lambda W, \bar{d}) < \infty$ then each n_i is odd and $r \leq \text{cat}(\Lambda W, \bar{d})$. It follows that $d_0 = 0$ in W^{even} and $\dim \text{Im } d_0 \leq \text{cat}(\Lambda W, \bar{d})$. The second inequality of (i) is just the Mapping theorem 29.5(ii).

(ii) is an immediate translation. □

Example 1 *Fibrations with $\text{cat } X = 0$.*

If $\text{cat } X = 0$ then X is contractible. Modify the constant map $PY \rightarrow pt \rightarrow Y$ to a fibre preserving map $PY \rightarrow X$, which is (automatically) a homotopy equivalence and so induces a weak homotopy equivalence $\Omega Y \rightarrow F$. This map is then a rational homotopy equivalence and so $\text{cat}_0 \Omega Y = \text{cat}_0 F$.

Thus we have two possibilities (Example 3, §28(d)): either $\text{cat}_0 F = \infty$ or else $\pi_*(\Omega Y) \otimes \mathbb{Q}$ is finite dimensional and concentrated in odd degrees. In the latter case, $\pi_*(Y) \otimes \mathbb{Q}$ is finite dimensional and concentrated in even degrees; thus Y has a Sullivan model of the form $(\Lambda V^{\text{even}}, 0)$. In particular, $\text{cat}_0(Y) = \infty$:

$$\text{cat } X = 0 \implies \max(\text{cat}_0 Y, \text{cat}_0 F) = \infty . \quad \square$$

Example 2 *Fibrations with $\text{cat } X = 1$.*

We construct examples of fibrations with $\text{cat } X = \text{cat}_0 X = 1$, and

$$\text{cat}_0 Y = n \quad \text{and} \quad n \leq \text{cat}_0 F \leq n + 1 ,$$

for any $n \geq 1$. For this, let $p_i : S_i^7 \rightarrow S_i^4$ be a copy of the Hopf fibration, with fibre S_i^3 , $1 \leq i \leq n$. Convert the composite map $\bigvee_{i=1}^n S_i^7 \rightarrow \prod_{i=1}^n S_i^7 \rightarrow \prod_{i=1}^n S_i^4$ into a fibration $p : X \rightarrow Y$ with fibre $F : Y = \prod_{i=1}^n S_i^4$ and $X \simeq \bigvee_{i=1}^n S_i^7$. In particular $\text{cat } X = \text{cat}_0 X = 1$, and $\text{cat}_0 Y = \text{cat } Y = n$.

Now $\pi_*(S_\alpha^4) \otimes \mathbb{Q} = \mathbb{Q}e_\alpha \oplus \mathbb{Q}e'_\alpha$ with $\deg e_\alpha = 4$ and $\deg e'_\alpha = 7$ (Example 1, §15(d)) and e'_α is in the image of $\pi_*(p_\alpha) \otimes \mathbb{Q}$ by construction. Thus each $e'_\alpha \in \text{Im } \pi_*(p) \otimes \mathbb{Q}$. On the other hand X is 6-connected and so $\partial_* \otimes \mathbb{Q}$ is a injective in $\pi_4(Y) \otimes \mathbb{Q}$. It follows that $\ker(\partial_* \otimes \mathbb{Q}) = \pi_7(Y) \otimes \mathbb{Q}$ and Proposition 30.9(ii) asserts that $n \leq \text{cat}_0 F \leq n + 1$. \square

When the fibration $p : X \rightarrow Y$ has a cross-section we obtain a lower bound for $\text{cat}_0 X$:

Proposition 30.10 *If the fibration $p : X \rightarrow Y$ has cross-section then $\text{cat}_0 X \geq \max(\text{cat}_0 Y, \text{cat}_0 F) = \text{cat}_0(Y \vee F)$.*

proof: Recall from the Example in §28(a) that $\max(\text{cat}_0 Y, \text{cat}_0 F) = \text{cat}_0(Y \vee F)$. Let $s : Y \rightarrow X$ be the cross-section: $ps = \text{id}_Y$. This exhibits Y as a retract of X so $\text{cat}_0 Y \leq \text{cat}_0 X$ and it exhibits $\pi_*(p)$ as surjective, so the inclusion $j : F \rightarrow Y$ induces an injection $\pi_*(j) \otimes \mathbb{Q}$ of rational homotopy groups. By the Mapping theorem 28.6, $\text{cat}_0 F \leq \text{cat}_0 X$ as well. \square

The next example shows that Proposition 30.10 is best possible.

Example 3 *Fibrations with $\text{cat}_0 X = \max(\text{cat}_0 Y, \text{cat}_0 F)$.*

For any simply connected topological spaces Y and Z convert the map $(\text{id}_Y, \text{const.}) : Y \vee Z \rightarrow Y$ into a fibration $p : X \rightarrow Y$ with $X \simeq Y \vee Z$, as described in §2(c). The inclusion $Y \rightarrow Y \vee Z$ then defines a cross-section s of this fibration; in particular the fibre F is simply connected.

Moreover, the inclusion $Z \rightarrow Y \vee Z$ defines an inclusion $i : Z \rightarrow F$. Let $j : F \rightarrow X$ be the inclusion. Since the fibration has a cross-section, $\pi_*(j) \otimes \mathbb{Q}$ is injective. Since ji is homotopic to the inclusion $Z \rightarrow Y \vee Z$, $\pi_*(ji) \otimes \mathbb{Q}$ is injective. Hence $\pi_*(i) \otimes \mathbb{Q}$ is also injective and the Mapping theorem 28.6 asserts that

$$\text{cat}_0 Z \leq \text{cat}_0 F \leq \text{cat}_0 X .$$

Thus $\text{cat}_0 X = \max(\text{cat}_0 Y, \text{cat}_0 Z) = \max(\text{cat}_0 Y, \text{cat}_0 F)$. \square

Exercises

1. Let $F \xrightarrow{i} X \xrightarrow{p} Y$ be a fibration in which X, Y and F are simply connected. Prove that $\text{cat} X \leq (\text{cat } i + 1) \cdot (\text{cat } p + 1) - 1$.
2. Let X be a simply connected space and let p be a prime number. Consider the Moore space $M^n(p) = S^n \cup_p e^{n+1}$. Prove that if X is a rational space, the inclusion $X \vee M^n(p) \rightarrow X \times M^n(p)$ is a homotopy equivalence. Supposing that $H^+(X; \mathbb{Q}) \neq 0$. Prove that $\text{cat}(X \times M^n(p)) \neq \text{cat}(X) + \text{cat}(M^n(p))$.
3. Let $F \xrightarrow{i} X \rightarrow Y$ be a fibration in which X, Y and F are simply connected. Suppose that $\dim H^{>n}(F; \mathbb{Q}) = 0$, and that there exists an element $\omega \in H^n(X; \mathbb{Q})$ such that $H^n(i)(\omega) \neq 0$. Prove that $\text{cat}_0(X) \geq \text{cat}_0(Y) + 1$.

4. Let $f : X \rightarrow Y$ be a continuous map between simply connected CW complexes of finite type. Suppose that $\pi_{2n}(f) \otimes \mathbb{Q}$ is injective for $n \geq 2$. Prove that

$$\text{cat}_0 f \leq \text{cat}_0 X \leq \text{cat}_0 f + \dim(\ker \pi_{\text{odd}}(f) \otimes \mathbb{Q}) .$$

31 The homotopy Lie algebra and the holonomy representation

In this section the ground ring is an arbitrary field \mathbb{k} of characteristic zero.

Recall from §21(d) that the homotopy Lie algebra, L_X , of a simply connected topological space X is the graded vector space $\pi_*(\Omega X) \otimes \mathbb{k}$, equipped with a Lie bracket defined via the Whitehead product in $\pi_*(X)$. In particular, (cf. Example 2, §21) each $x \in L_X$ determines the linear transformation $\text{ad } x : L_X \rightarrow L_X$, given by

$$\text{ad } x : y \longmapsto [x, y], \quad y \in L_X.$$

In this section (Theorem 31.17) we show that

- If $\text{cat}_0 X < \infty$ then for each non-zero $x \in (L_X)_{\text{even}}$ of sufficiently large degree there is some $y \in L_X$ such that the iterated Lie brackets $[x, [x, [x, \dots [x, y] \dots]]]$ are all non-zero.

A linear transformation $\varphi : V \rightarrow V$ in a graded vector space is called *locally nilpotent* if for each $v \in V$ there is an integer $n(v)$ such that $\varphi^{n(v)}v = 0$, and an element x in a graded Lie algebra is called an *Engel element* if $\text{ad } x$ is locally nilpotent. Thus we may restate the result above as: *if $\text{cat}_0 X < \infty$ then the non-zero Engel elements in $(L_X)_{\text{even}}$ are concentrated in finitely many degrees.* In particular, if $\text{cat}_0 X < \infty$ and if $(\dim L_X)_{\text{even}}$ is infinite then L_X is not abelian. We shall use this to show $\text{cat}_0 X = \infty$ in an example in which $e_0(X) = 2$ and the Milnor-Moore spectral sequence for X collapses at the E_3 -term.

The theorem above follows as a special case of a theorem of Jessup [99], which will be our principal objective in this section. For this we consider a Serre fibration

$$p : X \rightarrow Y$$

with fibre F at a basepoint $y_0 \in Y$, and such that Y is simply connected with rational homology of finite type. Associated with this fibration is a right representation (§23(c)) of the homotopy Lie algebra L_Y in $H_*(F; \mathbb{k})$, the *holonomy representation* for this fibration.

This representation, which is an important invariant of the fibration, is constructed as follows from the space $X \times_Y PY$ of §2(c). First, the right action of ΩY on $X \times_Y PY$ makes $H_*(X \times_Y PY; \mathbb{k})$ into a right $H_*(\Omega Y; \mathbb{k})$ -module as described in §8(a). Second, there is a natural weak homotopy equivalence $j : F \rightarrow X \times_Y PY$ (Proposition 2.5) and we use the isomorphism $H_*(j; \mathbb{k})$ to identify $H_*(F; \mathbb{k})$ as a right $H_*(\Omega Y; \mathbb{k})$ -module. Finally, since $H_*(\Omega Y; \mathbb{k}) = UL_Y$ (Milnor-Moore Theorem 21.5) the action of $H_*(\Omega Y; \mathbb{k})$ in $H_*(F; \mathbb{k})$ restricts to a right representation of L_Y .

Definition This representation of L_Y in $H_*(F; \mathbb{k})$ is the *holonomy representation* for the fibration $p : X \rightarrow Y$.

Observe now that any $x \in L_Y$ determines two linear transformations:

$$\text{ad } x : L_Y \longrightarrow L_Y \quad \text{and} \quad \text{hl } x : H_*(F; \mathbb{k}) \longrightarrow H_*(F; \mathbb{k}) ,$$

where $\text{hl } x$ is simply the restriction of the holonomy representation to x . Jessup's theorem asserts that if X and F are also simply connected with rational homology of finite type then:

- *If $\pi_*(p) \otimes \mathbb{k}$ is surjective and if there are r linearly independent elements $x_i \in (L_Y)_{\text{even}}$ such that $\text{ad } x_i$ and $\text{hl } x_i$ are both locally nilpotent, then*

$$\text{cat}_0 X \geq \text{cat}_0 F + r .$$

Jessup's theorem is proved by a careful analysis of the holonomy representation in terms of the Sullivan model of the fibration $p : X \rightarrow Y$. For this we first introduce the holonomy representation for an arbitrary minimal relative Sullivan algebra

$$(\Lambda V, d) \longrightarrow (\Lambda V \otimes \Lambda W, d)$$

in which $V = \{V^i\}_{i \geq 2}$ and $W = \{W^i\}_{i \geq 2}$ are graded vector spaces of finite type and $(\Lambda V, d)$ is itself a minimal Sullivan algebra.

Recall that the homotopy Lie algebra L of $(\Lambda V, d)$ is the graded Lie algebra defined by

$$V = \text{Hom}(sL, \mathbb{k}) \quad \text{and} \quad (\Lambda V, d_1) = C^*(L) ,$$

where d_1 is the quadratic part of the differential d in ΛV (§21(e) and Example 1, §23(a)). Now filter $(\Lambda V \otimes \Lambda W, d)$ by the ideals $F^p = \Lambda^{\geq p} V \otimes \Lambda W$ to obtain a first quadrant spectral sequence (E_i, δ_i) . Its E_0 -term is just

$$(E_0, \delta_0) = (\Lambda V \otimes \Lambda W, id \otimes \bar{d}) ,$$

\bar{d} denoting the quotient differential in ΛW , and so the E_1 -term, (E_1, δ_1) , is a $(\Lambda V, d_1)$ -module of the form

$$(E_1, \delta_1) = (\Lambda V \otimes H(\Lambda W, \bar{d}), \delta_1)$$

in which $\delta_1 : H(\Lambda W, \bar{d}) \rightarrow V \otimes H(\Lambda W, \bar{d})$. Thus (cf. (23.6)) a right representation of the homotopy Lie algebra L in $H(\Lambda W, \bar{d})$ is defined by

$$\alpha \cdot x = (-1)^{\text{deg } \alpha + \text{deg } x} \langle \delta_1(1 \otimes \alpha), sx \rangle , \quad \alpha \in H(\Lambda W, \bar{d}), \quad x \in L .$$

Definition This representation of L in $H(\Lambda W, \bar{d})$ is the *holonomy representation* for the relative Sullivan algebra $(\Lambda V, d) \rightarrow (\Lambda V \otimes \Lambda W, d)$.

Now suppose the relative Sullivan algebra $(\Lambda V \otimes \Lambda W, d)$ is a model for the fibration $p : X \rightarrow Y$, as in (15.4). This determines a quasi-isomorphism $(\Lambda W, \bar{d}) \xrightarrow{\cong} A_{PL}(F)$, and so identifies $H(\Lambda W, \bar{d}) = H^*(F; \mathbb{k})$. On the other hand, Theorem 21.6 identifies L with L_Y , so that the holonomy representation for the fibration is a right representation of L in $H_*(F; \mathbb{k})$. In Theorem 31.3 we show that

- The holonomy representations of L in $H(\Lambda W, \bar{d})$ and in $H_*(F; \mathbb{k})$ are dual up to sign.

This permits the translation of hypotheses on the holonomy representation of L_Y in $H_*(F; \mathbb{k})$ into conditions on the differential in the Sullivan model $(\Lambda V \otimes \Lambda W, d)$ where they can be applied, in particular, to prove Jessup's theorem.

An important aspect of the holonomy representation for any relative Sullivan algebra $(\Lambda V, d) \rightarrow (\Lambda V \otimes \Lambda W, d)$ is that it can be expressed in terms of derivations of the quotient Sullivan algebra $(\Lambda W, \bar{d})$, (a derivation θ in a differential graded algebra (A, d_A) is a derivation in A such that $\theta d_A = (-1)^{\deg \theta} d_A \theta$). More precisely, if v_i is a basis of V , derivations θ_i of $(\Lambda W, \bar{d})$ are defined by

$$d(1 \otimes \Phi) - 1 \otimes \bar{d}\Phi - \sum_i v_i \otimes \theta_i \Phi \in \Lambda^{\geq 2} V \otimes \Lambda W, \quad \Phi \in \Lambda W.$$

Thus by definition the spectral sequence differential $\delta_1 : H(\Lambda W, \bar{d}) \rightarrow V \otimes H(\Lambda W, \bar{d})$ is given by $\delta_1[\Phi] = \sum_i v_i \otimes H(\theta_i)[\Phi]$. It follows that if x_j is the dual basis of L ($\langle v_i, s x_j \rangle = 1$ or 0 as $i = j$ or $i \neq j$), then

$$\alpha \cdot x_i = (-1)^{\deg x_i (\deg \alpha + 1)} H(\theta_i) \alpha, \quad \alpha \in H(\Lambda W, \bar{d}). \tag{31.1}$$

Formula (31.1) expresses the holonomy representation for the relative Sullivan algebra in terms of the derivations $H(\theta_i)$. However, the derivations θ_i themselves carry more information. For example, if $V = \mathbb{k}v$ and $\deg v$ is odd then the entire differential in $\Lambda v \otimes \Lambda W$ is given by

$$dv = 0, \quad \text{and} \quad d(1 \otimes \Phi) = 1 \otimes \bar{d}\Phi + v \otimes \theta\Phi, \quad \Phi \in \Lambda W.$$

In particular, any derivation θ' of $(\Lambda W, \bar{d})$ with $\deg \theta' = 1 - \deg v$ determines a relative Sullivan algebra $\Lambda v \rightarrow (\Lambda v \otimes \Lambda W, d')$ by the formula $d' = 1 \otimes \bar{d} + v \otimes \theta'$.

Note as well that (in general) the holonomy representation is characterized by

$$(\Lambda V \otimes H(\Lambda W, \bar{d}), \delta_1) = C^*(L; H(\Lambda W, \bar{d}))$$

(cf. §23(c)). In particular, the spectral sequence above converges from

$$E_2 = \text{Ext}_{UL}(\mathbb{k}, H(\Lambda W, \bar{d})) \implies H(\Lambda V \otimes \Lambda W, d).$$

This section is organized into the following topics

- The holonomy representation for a Sullivan model.
- Local nilpotence and local conilpotence.
- Jessup's theorem.
- Proof of Jessup's theorem.
- Examples.

(f) Iterated Lie brackets.

(a) The holonomy representation for a Sullivan model.

Consider a Serre fibration $p : X \rightarrow Y$ with fibre inclusion $j : F \rightarrow X$, and such that F, X and Y are simply connected and have rational homology of finite type. Let $\lambda : (\Lambda V, d) \rightarrow (\Lambda V \otimes \Lambda W, d)$ be a minimal relative Sullivan algebra that is a minimal Sullivan model for the fibration in the sense of (15.4); in particular we have the commutative diagram

$$\begin{array}{ccccc}
 A_{PL}(Y) & \xrightarrow{A_{PL}(p)} & A_{PL}(X) & \longrightarrow & A_{PL}(F) \\
 m_Y \uparrow \simeq & & \simeq \uparrow m & & \simeq \uparrow \bar{m} \\
 (\Lambda V, d) & \xrightarrow{\lambda} & (\Lambda V \otimes \Lambda W, d) & \longrightarrow & (\Lambda W, \bar{d}),
 \end{array} \tag{31.2}$$

in which m_Y and \bar{m} are minimal Sullivan models and m is a Sullivan model.

Use $H(\bar{m})$ to identify $H(\Lambda W, \bar{d}) = H^*(F; \mathbb{k}) = \text{Hom}(H_*(F; \mathbb{k}), \mathbb{k})$, and use Theorem 21.5 to identify the homotopy Lie algebra L_Y for Y with the homotopy Lie algebra L for $(\Lambda V, d)$. Recall the two holonomy representations of L , one in $H(\Lambda W, \bar{d})$ and one in $H_*(F; \mathbb{k})$, defined in the introduction to this section.

Theorem 31.3 *These two representations are dual (up to sign):*

$$\langle \alpha \cdot x, \beta \rangle = -(-1)^{\text{deg } x \text{ deg } \beta} \langle \alpha, \beta \cdot x \rangle, \quad \alpha \in H(\Lambda W, \bar{d}), \beta \in H_*(F; \mathbb{k}), x \in L.$$

proof: As in §16(b) we may apply the construction in §15(a) to the path space fibration $q : PY \rightarrow Y$ to obtain a commutative diagram

$$\begin{array}{ccccc}
 A_{PL}(Y) & \xrightarrow{A_{PL}(q)} & A_{PL}(PY) & \longrightarrow & A_{PL}(\Omega Y) \\
 m_Y \uparrow \simeq & & \simeq \uparrow n & & \simeq \uparrow \bar{n} \\
 (\Lambda V, d) & \longrightarrow & (\Lambda V \otimes \Lambda \bar{V}, d) & \longrightarrow & (\Lambda \bar{V}, 0)
 \end{array}$$

of Sullivan models. Now consider the pullback diagram of ΩY -fibrations

$$\begin{array}{ccc}
 X \times_Y PY & \xrightarrow{g} & PY \\
 \downarrow f & & \downarrow \\
 X & \xrightarrow{p} & Y.
 \end{array}$$

Diagram (31.2) provides a Sullivan model $m : (\Lambda V \otimes \Lambda W, d) \xrightarrow{\cong} A_{PL}(X)$ and a Sullivan representative for p , $\lambda : (\Lambda V, d) \rightarrow (\Lambda V \otimes \Lambda W, d)$, such that $m\lambda = A_{PL}(p)m_Y$. We may therefore, as in §15(a), construct

$$\xi = A_{PL}(f)m \cdot A_{PL}(g)n : (\Lambda V \otimes \Lambda W, d) \otimes_{\Lambda V} (\Lambda V \otimes \Lambda \bar{V}, d) \rightarrow A_{PL}(X \times_Y PY).$$

Moreover, Proposition 15.8 asserts that ξ is a Sullivan model of the form

$$\xi : (\Lambda V \otimes \Lambda W \otimes \Lambda \bar{V}, d) \xrightarrow{\cong} A_{PL}(X \times_Y PY).$$

(Note that $\Lambda V \otimes \Lambda W$ and $\Lambda V \otimes \Lambda \bar{V}$ are sub cochain algebras.)

Next consider the composite Serre fibration $p \circ f : X \times_Y PY \rightarrow Y$. The fibre at y_0 is $F \times \Omega Y$ and the inclusion of the fibre is the continuous map

$$a : F \times \Omega Y \rightarrow X \times_Y PY, \quad a : (z, \gamma) \mapsto (jz) \cdot \gamma, \quad z \in F, \gamma \in \Omega Y.$$

A straightforward check shows that in this case diagram (15.4) has the form

$$\begin{array}{ccccc} A_{PL}(Y) & \xrightarrow{A_{PL}(p \circ f)} & A_{PL}(X \times_Y PY) & \xrightarrow{A_{PL}(a)} & A_{PL}(F \times \Omega Y) \\ m_Y \uparrow \simeq & & \simeq \uparrow \xi & & \simeq \uparrow \bar{m} \cdot \bar{n} \\ (\Lambda V, d) & \longrightarrow & (\Lambda V \otimes \Lambda W \otimes \Lambda \bar{V}, d) & \xrightarrow{\varepsilon \cdot id} & (\Lambda W, \bar{d}) \otimes (\Lambda \bar{V}, 0). \end{array} \quad (31.4)$$

Let u be a cocycle in $(\Lambda W, \bar{d})$ representing $\alpha \in H^*(F; \mathbb{k})$. If $\Theta : \Lambda W \rightarrow V \otimes \Lambda W$ is the map defined by $d\Phi - 1 \otimes \bar{d}\Phi - \Theta\Phi \in \Lambda^{\geq 2}V \otimes \Lambda W$, then by definition $H(\Theta) = \delta_1$ and

$$\alpha \cdot x = (-1)^{\deg \alpha + \deg x} \langle H(\Theta)\alpha; sx \rangle. \quad (31.5)$$

On the other hand, the weak homotopy equivalence $j : F \rightarrow X \times_Y PY$ is represented by the surjective quasi-isomorphism $\varepsilon \cdot id \cdot \varepsilon : (\Lambda V \otimes \Lambda W \otimes \Lambda \bar{V}, d) \rightarrow (\Lambda W, \bar{d})$. Let $w \in \Lambda V \otimes \Lambda W \otimes \Lambda \bar{V}$ be a cocycle that maps to u . Then it follows from diagram (31.4) that for $\beta \in H_*(F; \mathbb{k})$,

$$\begin{aligned} \langle \alpha, \beta \cdot x \rangle &= \langle H^*(a)H^*(j)^{-1}\alpha, \beta \otimes hur(x) \rangle \\ &= \langle H(\varepsilon \cdot id)[w], \beta \otimes hur(x) \rangle. \end{aligned}$$

But by construction we may write

$$w = 1 \otimes u \otimes 1 + w_1 \otimes 1 + \sum_i 1 \otimes u_i \otimes v_i + \Phi$$

where $w_1 \in V \otimes \Lambda W$, $u_i \in \Lambda W$, $v_i \in \bar{V}$ and $\Phi \in \Lambda^{\geq 2}(V \oplus \bar{V}) \cdot \Lambda(V \otimes \Lambda W \otimes \Lambda \bar{V})$. From $dw = 0$ we deduce that $\bar{d}u_i = 0$ and hence that

$$\langle \alpha, \beta \cdot x \rangle = (-1)^{\deg \beta \deg x} \sum_i \langle [u_i], \beta \rangle \langle [v_i], hur(x) \rangle.$$

Furthermore, if $d_0 : \bar{V} \xrightarrow{\cong} V$ is the linear part of the differential in $\Lambda V \otimes \Lambda \bar{V}$ we also deduce from $dw = 0$ that $\Theta u + (id \otimes \bar{d})w_1 + \sum_i (-1)^{\deg u, \deg v_i} d_0 v_i \otimes u_i = 0$.

Thus (31.5) becomes

$$\langle \alpha \cdot x, \beta \rangle = - \sum_i \langle d_0 v_i; sx \rangle \langle [u_i], \beta \rangle .$$

Finally, recall that $L \cong L_Y = \pi_*(\Omega Y) \otimes \mathbb{k}$ and that sL_Y is identified with $\pi_*(Y) \otimes \mathbb{k}$ via $sx = -(-1)^{\deg x} \partial_*^{-1} x$, where ∂_* is the connecting homomorphism of the path space fibration (§21(e)). Thus the formula in the proof of Proposition 15.13 becomes $\langle d_0 v_i; sx \rangle = \langle v_i; x \rangle = \langle [v_i], hur(x) \rangle$, where $\langle \alpha, \beta \cdot x \rangle = -(-1)^{\deg \beta \deg x} \langle \alpha \cdot x, \beta \rangle$. □

Again suppose $p : X \rightarrow Y$ is a Serre fibration with fibre F , and with X, Y and F simply connected and having rational homology of finite type. The holonomy representation of the homotopy Lie algebra L_Y in the homology $H_*(F; \mathbb{k})$ of the fibre is an important measure of the non-triviality of the fibration: the holonomy representation for the product fibration is trivial. More generally we have

Proposition 31.6 *Let $p : X \rightarrow Y$ be a Serre fibration with fibre F , and suppose Y is simply connected with rational homology of finite type. If $H^*(X; \mathbb{k}) \rightarrow H^*(F; \mathbb{k})$ is surjective then the holonomy representation of L_Y in $H_*(F; \mathbb{k})$ is trivial.*

proof: Let $(\Lambda V \otimes \Lambda W, d)$ be a minimal Sullivan model for the fibration as in (15.4). Then for any cohomology class $\alpha \in H(\Lambda W, \bar{d})$ there is a d -cocycle $\Psi \in \Lambda V \otimes \Lambda W$ of the form $\Psi = 1 \otimes \Psi_0 + \Psi_1 + \dots$ such that $\Psi_i \in \Lambda^i V \otimes \Lambda W$ and Ψ_0 is a \bar{d} -cocycle representing α .

As in the introduction, choose a basis v_i of V and define derivations θ_i of $(\Lambda W, \bar{d})$ by $d(1 \otimes \Phi) - 1 \otimes \bar{d}\Phi - \sum v_i \otimes \theta_i \Phi \in \Lambda^{\geq 2} V \otimes \Lambda W$. Then (formula (31.1)) the holonomy representation in $H(\Lambda W, \bar{d})$ is given by $\alpha \cdot x_i = \pm H(\theta_i)\alpha$, where x_i is the dual basis of the homotopy Lie algebra L of $(\Lambda V, d)$. Here we have $d\Psi = 0$ and so $\sum v_i \otimes \theta_i \Psi_0 = -(id \otimes \bar{d})\Psi_1$. Thus each $H(\theta_i) = 0$ and the holonomy representation in $H_*(F; \mathbb{k})$ is trivial (Theorem 31.3). □

(b) Local nilpotence and local conilpotence.

Recall that a linear map $\gamma : M \rightarrow M$ in a graded vector space is *locally nilpotent* if every $v \in M$ is in the kernel of some power γ^k of γ . We shall make frequent use of the dual notion:

Lemma 31.7 *Suppose $\sigma : M \rightarrow M$ is a linear map of non-zero degree in a graded vector space $M = \{M^p\}_{p \in \mathbb{Z}}$ of finite type. Then the following conditions are equivalent:*

- (i) *The dual linear map in $\text{Hom}(M, \mathbb{k})$ is locally nilpotent.*

(ii) For each p there is an integer $k(p)$ such that $M^p \cap \text{Im } \sigma^{k(p)} = 0$.

(iii) If $(w_k)_{k \geq 0}$ is an infinite sequence of elements of M such that $\sigma w_{k+1} = w_k$, $k \geq 0$ then $w_k = 0$, $k \geq 0$.

(iv) $\bigcap_{k=0}^{\infty} \text{Im } \sigma^k = 0$.

Definition A linear transformation of non-zero degree in a graded vector space of finite type is called *locally conilpotent* if it satisfies the conditions of Lemma 31.7.

proof of Lemma 31.7: (i) \iff (ii): Denote the linear map dual to σ by f . Then

$$\langle M, f^k (\text{Hom}(M, \mathbb{k})_p) \rangle = \langle M^p \cap \text{Im } \sigma^k, \text{Hom}(M, \mathbb{k})_p \rangle .$$

Thus if (ii) holds then $f^{k(p)} = 0$ in $\text{Hom}(M, \mathbb{k})_p$, $p \in \mathbb{Z}$, and f is locally nilpotent. Conversely, if (i) holds then $f^{k(p)} = 0$ in $\text{Hom}(M, \mathbb{k})_p$ for some $k(p)$, because this vector space is finite dimensional. Thus $M^p \cap \text{Im } \sigma^{k(p)} = 0$ and (ii) holds.

(ii) \iff (iii): Clearly (ii) \implies (iii). If (ii) fails then for some p and each k , $M^p \cap \text{Im } \sigma^k \neq 0$. Set $A_k = (\sigma^{k+1})^{-1} (M^p - \{0\})$. Then $A_0 \xleftarrow{\sigma} A_1 \xleftarrow{\sigma} A_2 \xleftarrow{\sigma} \dots$ is an infinite sequence of linear maps between non-void affine spaces. For dimension reasons the sequences $A_k \supset \sigma(A_{k+1}) \supset \sigma^2(A_{k+2}) \supset \dots$ must stabilize at some integer $K(k) : \sigma^n(A_{k+n}) = \sigma^{K(k)}(A_{k+K(k)})$ for $n \geq K(k)$.

Put $E_k = \sigma^{K(k)}(A_{k+K(k)})$. Then for n large enough

$$\sigma(E_{k+1}) = \sigma(\sigma^n(A_{k+1+n})) = \sigma^{n+1}(A_{k+n+1}) = E_k .$$

Thus we may inductively construct elements $w_k \in E_k$ so that $\sigma w_{k+1} = w_k$. Moreover, since $A_k = (\sigma^{k+1})^{-1} (M^p - \{0\})$ no element in A_k is zero, so $w_k \neq 0$, $k \geq 0$.

(ii) \iff (iv): Clearly (ii) \implies (iv) and the reverse implication follows from decreasing sequence $M^p \supset M^p \cap \text{Im } \sigma \supset M^p \cap \text{Im } \sigma^2 \supset \dots$ and the fact that M^p is finite dimensional. \square

Example 1 *The holonomy representation.*

Suppose $(\Lambda V, d) \rightarrow (\Lambda V \otimes \Lambda W, d)$ is a relative Sullivan algebra as in the introduction to this section and let (v_i) be a basis of V . Let L be the homotopy Lie algebra of $(\Lambda V, d)$ and denote by $\text{hl}' x$, $x \in L$, the holonomy representation of L in $H(\Lambda W, \bar{d})$. Recall from the introduction that derivations θ_i in $(\Lambda V, d)$ are determined by the equations

$$d(1 \otimes \Phi) - \left(1 \otimes \bar{d}\Phi + \sum_i v_i \otimes \theta_i \Phi \right) \in \Lambda^{\geq 2} V \otimes \Lambda W , \quad \Phi \in \Lambda W .$$

Formula (31.1) states that $H(\theta_i)$ coincides (up to sign) with $\text{hl}' x_i$, where (x_i) is the basis of L dual to the basis (v_i) . Thus Lemma 31.7 asserts that the following conditions are equivalent:

- $\text{hl}' x_i$ is locally conilpotent.
- For each p there is an integer $k(p)$ such that $H^p(\Lambda W, \bar{d}) \cap \text{Im } H(\theta_i)^{k(p)} = 0$.
- If $(\alpha_k)_{k \geq 0}$ is an infinite sequence of elements of $H(\Lambda W, \bar{d})$ such that $H(\theta_i)\alpha_{k+1} = \alpha_k$, $k \geq 0$, then $\alpha_k = 0$, $k \geq 0$.
- $\bigcap_{k=0}^{\infty} \text{Im } H(\theta_i)^k = 0$.

□

Example 2 *The adjoint representation.*

Let L be the homotopy Lie algebra of a minimal Sullivan algebra $(\Lambda V, d)$ in which $V = V^{\geq 2}$ is a graded vector space of finite type. Each $x \in L$ determines the linear function $V \rightarrow \mathbb{k}$ given by $v \mapsto \langle v; sx \rangle$. Extend this to a derivation, η_x , in ΛV and define a derivation ξ_x in $(\Lambda V, d)$ by setting $\xi_x = d\eta_x - (-1)^{\text{deg } \eta_x} \eta_x d$.

Because $(\Lambda V, d)$ is minimal ξ_x preserves $\Lambda^+ V$. Define $f_x : V \rightarrow V$ by requiring

$$\xi_x - f_x : V \rightarrow \Lambda^{\geq 2} V ;$$

f_x is the linear part of ξ_x . We show now that

$$\langle f_x v; sy \rangle = (-1)^{\text{deg } x \text{ deg } y} \langle v; s[x, y] \rangle , \quad v \in V, y \in L .$$

This formula exhibits f_x as the dual (up to sign) of $\text{ad } x$. In particular, f_x is locally conilpotent if and only if $\text{ad } x$ is locally nilpotent.

For the proof of (31.8) note that $f_x = d_1 \eta_x - (-1)^{\text{deg } \eta_x} \eta_x d_1$, where d_1 is the quadratic part of d . Then use §21(e) to compute

$$\begin{aligned} \langle f_x v; sy \rangle &= -(-1)^{\text{deg } \eta_x} \langle \eta_x d_1 v; sy \rangle = (-1)^{\text{deg } x} \langle d_1 v; sy, sx \rangle \\ &= (-1)^{\text{deg } x \text{ deg } y} \langle v; s[x, y] \rangle . \end{aligned}$$

□

We shall need one more observation about local conilpotence: its good behaviour with respect to spectral sequences. Indeed, suppose $\sigma : (M, d) \rightarrow (M, d)$ is a linear transformation of a graded vector space of finite type and suppose further that both σ and d preserve a filtration of M of the form

$$M = F^0 M \supset F^1 M \supset \dots \supset F^p M \supset \dots$$

in which $\bigcap_p F^p M = 0$. This determines a cohomology spectral sequence (E_i, d_i) and a morphism $E_i(\sigma) : (E_i, d_i) \rightarrow (E_i, d_i)$.

Lemma 31.8 *If some $E_i(\sigma)$ is locally conilpotent then so is $H(\sigma)$.*

proof: If $H(\sigma)$ is not locally conilpotent then there is an infinite sequence of non-zero classes $\alpha_k \in H(M)$, such that $H(\sigma)\alpha_{k+1} = \alpha_k$, $k \geq 0$. Let $p(k)$ be

the greatest integer such that α_k has a representing cocycle in $F^{p(k)}M$. Since $p(k) \geq p(k+1) \geq \dots$ there is a p and a k_0 such that $p(k) = p, k \geq k_0$.

Let Z_k be the affine space of cocycles in F^p representing $\alpha_k, k \geq k_0$. Then $\sigma^n(Z_{k+n}) \supset \sigma^{n+1}(Z_{k+n+1}) \supset \dots$ is a decreasing sequence of finite dimensional affine subspaces and hence $A_k = \bigcap_n \sigma^n(Z_{k+n})$ is non void subspace of Z_k . Exactly as in Lemma 31.7 it follows that $\sigma(A_{k+1}) = A_k$, and so there is a sequence of cocycles $z_k \in A_k$ such that $\sigma z_{k+1} = z_k$ and z_k represents α_k .

Since $p = p(k)$ and $z_k \in F^p, z_k$ represents a non-zero class $[z_k] \in E_i^{p,*}$. But clearly $E_i(\sigma)[z_{k+1}] = [z_k], k \geq k_0$, and so if $H(\sigma)$ is not locally conilpotent then $E_i(\sigma)$ is not locally conilpotent either. \square

Examples 1 and 2 allow us to prove a technical lemma that is important for the proof of Jessup's theorem, and in §33. Consider a minimal Sullivan algebra of the form $(\Lambda v \otimes \Lambda U \otimes \Lambda W, D)$ in which

- v has odd degree and $Dv = 0$.
- $(\Lambda v \otimes \Lambda U, d) \rightarrow (\Lambda v \otimes \Lambda U \otimes \Lambda W, D)$ is a relative Sullivan algebra.

Then a derivation, θ , of the quotient. Sullivan algebra $(\Lambda U \otimes \Lambda W, \bar{d})$ is defined by $D(1 \otimes \Phi) = 1 \otimes \bar{D}\Phi + v \otimes \theta\Phi$.

Next, let L be the homotopy Lie algebra of $(\Lambda v \otimes \Lambda U, D)$ and denote by ad and by hl' the adjoint representation of L , and the holonomy representation of L in $H(\Lambda W, \bar{d})$, where \bar{d} is the quotient differential in ΛW . Define $x \in L$ by $\langle v; sx \rangle = 1$ and $\langle U; sx \rangle = 0$. Then we have

Lemma 31.9 *With the notation and hypotheses above suppose $\text{ad } x$ is locally nilpotent and $\text{hl}' x$ is locally conilpotent. Then $H(\theta)$ is locally conilpotent.*

proof: First observe that θ preserves ΛU and also Λ^+U , because $(\Lambda v \otimes \Lambda U, D)$ is a minimal Sullivan algebra. Next, let η be the derivation in $\Lambda v \otimes \Lambda U$ defined by $\eta w = \langle w; sx \rangle, w \in \mathbb{k}v \oplus U$; thus $\eta v = 1$ and $\eta(U) = 0$, and thus setting $\xi = D\eta - (-1)^{\text{deg } \eta} \eta D$ we have

$$\xi(1 \otimes \Phi) = 1 \otimes \theta\Phi, \quad \Phi \in \Lambda U.$$

Define $f : U \rightarrow U$ by the condition $\xi - f : U \rightarrow \Lambda^{\geq 2}U$. Then Example 2 states that f is dual (up to sign) to $\text{ad } x$. In particular f is locally conilpotent.

Next, filter $\Lambda U \otimes \Lambda W$ by the ideals $F^p = \Lambda^{\geq p}U \otimes \Lambda W$. Since θ preserves Λ^+U it preserves this filtration and in the corresponding spectral sequence we have

$$E_1(\theta) = \theta_f \otimes \text{id} + \text{id} \otimes H(\theta_v) : \Lambda U \otimes H(\Lambda W, \bar{d}) \rightarrow \Lambda U \otimes H(\Lambda W, \bar{d}),$$

where θ_f is the derivation in ΛU extending f . Now $H(\theta_v)$ is locally conilpotent by hypothesis, and we have just observed that so is f , because $\text{ad } x$ is locally nilpotent. Given a positive integer n choose N so that for $k \geq 0$:

$$U^{\leq n} \cap f^k(U^{\geq N}) = 0 \quad \text{and} \quad H^{\leq n}(\Lambda W, \bar{d}) \cap H(\theta_v)^k(H^{\geq N}(\Lambda W, \bar{d})) = 0.$$

Then the formula above for $E_1(\theta)$ implies that

$$[\Lambda^p U \otimes H(\Lambda W, \bar{d})]^n \cap E_1(\theta)^k [\Lambda^p U \otimes H(\Lambda W, \bar{d})]^{\geq (p+1)N} = 0, \quad k \geq 0.$$

Hence $E_1(\theta)$ is locally conilpotent and thus so is $H(\theta)$, by Lemma 31.8. \square

(c) Jessup's theorem.

Consider a fibration

$$p : X \longrightarrow Y$$

of simply connected topological spaces with simply connected fibre F and such that Y and F (and hence X) have rational homology of finite type. Let $\partial_* \otimes \mathbb{k} : \pi_*(Y) \otimes \mathbb{k} \longrightarrow \pi_{*-1}(F) \otimes \mathbb{k}$ denote the connecting homomorphism and let hl denote the holonomy representation of the homotopy Lie algebra L_Y in $H_*(F; \mathbb{k})$.

Theorem 31.10 (Jessup [99]) *Suppose in the fibration $p : X \longrightarrow Y$ that $\partial_* \otimes \mathbb{k} = 0$. Assume there are r linearly independent elements $x \in (L_Y)_{\text{even}}$ such that both $ad\ x$ and $hl\ x$ are locally nilpotent. Then*

$$\text{cat}_0 X \geq \text{cat}_0 F + r.$$

We shall deduce Theorem 31.10 from its translation into Sullivan algebras. For this we consider a minimal relative Sullivan algebra

$$(\Lambda V, d) \longrightarrow (\Lambda V \otimes \Lambda W, d)$$

in which $V = V^{\geq 2}$ and $W = W^{\geq 2}$ are graded vector spaces of finite type, and $(\Lambda V, d)$ is itself a minimal Sullivan algebra. Choose a basis v_1, v_2, \dots of V such that $\deg v_i \leq \deg v_{i+1}$ and define derivations θ_i in the quotient Sullivan algebra $(\Lambda W, \bar{d})$ by requiring

$$d(1 \otimes \Phi) - 1 \otimes \bar{d}\Phi - \sum_i v_i \otimes \theta_i \Phi \in \Lambda^{\geq 2} V \otimes \Lambda W, \quad \Phi \in \Lambda W.$$

Then let (x_i) be the dual basis of the homotopy Lie algebra L of $(\Lambda V, d)$.

Theorem 31.11 *Suppose in the relative Sullivan algebra $(\Lambda V, d) \longrightarrow (\Lambda V \otimes \Lambda W, d)$ that the linear part of the differential in $\Lambda V \otimes \Lambda W$ is zero. Assume that in the basis of L there are r elements x_i of even degree such that $ad\ x_i$ is locally nilpotent and $H(\theta_i)$ is locally conilpotent. Then*

$$\text{cat}(\Lambda V \otimes \Lambda W, d) \geq \text{cat}(\Lambda W, \bar{d}) + r.$$

We show first that Theorem 31.11 does imply Theorem 31.10. Indeed, choose $(\Lambda V, d) \longrightarrow (\Lambda V \otimes \Lambda W, d)$ to be a rational Sullivan model for the fibration $p :$

$X \rightarrow Y$ as described in (15.4). Then $(\Lambda V, d)$ is a minimal Sullivan model for Y and $L = L_Y$. Thus the linear part of the differential in $\Lambda V \otimes \Lambda W$ is zero, because it is dual to $\partial_* \otimes \mathbb{k}$ (Proposition 15.13). Suppose there are r linearly independent elements $x \in L_{\text{even}}$ such that $\text{ad } x$ and $\text{hl } x$ are locally nilpotent. Choose a basis v_1, v_2, \dots of V such that $\text{deg } v_1 \leq \text{deg } v_2 \leq \dots$ and so that these r elements appear as a subset x_{i_1}, \dots, x_{i_r} of the dual basis (x_i) of L . Then $\text{ad } x_{i_r}$ is locally nilpotent. Moreover, $H(\theta_{i_r})$ is dual (up to sign) to $\text{hl } x_{i_r}$, by formula (31.1) and Theorem 31.3. Thus $H(\theta_{i_r})$ is locally conilpotent.

This shows that the minimal Sullivan model of $p : X \rightarrow Y$ satisfies the hypotheses of Theorem 31.11. Now let $(\Lambda U', d)$ and $(\Lambda W', d)$ be minimal rational Sullivan models for X and for F . Then $(\Lambda U', d) \otimes \mathbb{k}$ and $(\Lambda W', d) \otimes \mathbb{k}$ are minimal Sullivan models (over \mathbb{k}) for X and F . It follows that $\text{cat}(\Lambda V \otimes \Lambda W, d) = \text{cat}(\Lambda U', d) = \text{cat}_0 X$ and $\text{cat}(\Lambda W, \bar{d}) = \text{cat}(\Lambda W', d) = \text{cat}_0 F$ (Example 1, §29(e) and Proposition 29.4). Thus Theorem 31.10 follows from Theorem 31.11.

The proof of Theorem 31.11 will occupy the next two topics. First, in §31(d), we shall consider the special case that $V = \mathbb{k}v$ and $\text{deg } v$ is odd, so that ΛV is the exterior algebra Λv . Then in §31(e) we shall use induction and the mapping theorem to prove the theorem in general.

(d) Proof of Jessup’s theorem.

Consider first a minimal Sullivan algebra of the form $(\Lambda v \otimes \Lambda W, d)$ in which $\text{deg } v$ is odd. Thus the differential is described by: $dv = 0$ and

$$d(1 \otimes \Phi) = 1 \otimes \bar{d}\Phi + v \otimes \theta\Phi, \quad \Phi \in \Lambda W, \tag{31.12}$$

where θ is a derivation in the quotient Sullivan algebra $(\Lambda W, \bar{d})$.

In this case Theorem 31.11 reduces to

Proposition 31.13 *If $H(\theta)$ is locally conilpotent then*

$$\text{cat}(\Lambda v \otimes \Lambda W, d) \geq \text{cat}(\Lambda W, \bar{d}) + 1 .$$

proof: Let $\text{cat}(\Lambda v \otimes \Lambda W, d) = m + 1$. The ideals $v \otimes (\Lambda W, \bar{d})$ and $v \otimes (\Lambda^{>m} W, \bar{d})$ are in particular $(\Lambda v \otimes \Lambda W, d)$ -modules. Let $\xi : (Q, d) \xrightarrow{\cong} v \otimes (\Lambda W / \Lambda^{>m} W, \bar{d})$ be a $(\Lambda v \otimes \Lambda W, d)$ -semifree resolution for the quotient module. Define $\iota_Q \in H(Q)$ by $H(\xi)\iota_Q = [v \otimes 1]$.

Next, observe that Q extends to the $(\Lambda v \otimes \Lambda W, d)$ -semifree module $(Q \otimes N, d)$ defined as follows: N is a graded space with basis $(a_n)_{0 \leq n < \infty}$ and $\text{deg } a_n = n(\text{deg } v - 1)$, the module action is $\Phi \cdot (z \otimes a_n) = \Phi z \otimes a_n$ for $\Phi \in \Lambda v \otimes \Lambda W$, $z \in Q$, and the differential is given by

$$d(z \otimes a_0) = dz \otimes a_0 \quad \text{and} \quad d(z \otimes a_n) = dz \otimes a_n + vz \otimes a_{n-1}, \quad n \geq 1 .$$

We identify Q with $Q \otimes a_0$ via $z \longleftrightarrow z \otimes a_0$.

The proof of the proposition then consists of the following four steps.

Step 1: Construction of a morphism of $(\Lambda v \otimes \Lambda W, d)$ -modules $\gamma : (Q, d) \rightarrow (\Lambda v \otimes \Lambda W, d)$ such that $H(\gamma)\iota_Q = [v \otimes 1]$.

Step 2: Extension of γ to a morphism $\alpha : (Q \otimes N, d) \rightarrow (\Lambda v \otimes \Lambda W, d)$.

Step 3: Construction of a homotopy from α to a morphism β with image in $v \otimes \Lambda W$.

Step 4: Proof that $\text{cat}(\Lambda W, \bar{d}) \leq m$.

We now carry out this program.

Step 1: *Construction of a morphism of $(\Lambda v \otimes \Lambda W, d)$ -modules $\gamma : (Q, d) \rightarrow (\Lambda v \otimes \Lambda W, d)$ such that $H(\gamma)\iota_Q = [v \otimes 1]$.*

Let $I(m+1) = \Lambda^{> m+1}(v \oplus W) \subset \Lambda v \otimes \Lambda W$ and let $\zeta : (P, d) \xrightarrow{\cong} (\Lambda v \otimes \Lambda W / I(m+1), d)$ be a $(\Lambda v \otimes \Lambda W, d)$ -semifree resolution. Define $\iota_P \in H(P, d)$ by: $H(\zeta)\iota_P = [1]$. Since $\text{cat}(\Lambda v \otimes \Lambda W, d) = m+1$ there is a morphism $\eta : (P, d) \rightarrow (\Lambda v \otimes \Lambda W, d)$ of $(\Lambda v \otimes \Lambda W, d)$ -modules such that $\eta(\iota_P) = [1]$. (This is just the definition of $\text{cat}(\Lambda v \otimes \Lambda W, d)$ if we take for (P, d) the minimal Sullivan model of the surjection $\Lambda v \otimes \Lambda W \rightarrow \Lambda v \otimes \Lambda W / I(m+1)$.)

Next observe that the inclusion of the ideal $v \otimes (\Lambda W, \bar{d})$ in $(\Lambda v \otimes \Lambda W, d)$ factors to define a morphism

$$\varphi : v \otimes (\Lambda W / \Lambda^{> m} W, \bar{d}) \rightarrow (\Lambda v \otimes \Lambda W / I(m+1), d)$$

of $(\Lambda v \otimes \Lambda W, d)$ -modules. Lift φ to a morphism $\varphi' : (Q, d) \rightarrow (P, d)$ such that $\zeta\varphi' \sim \varphi\xi$.

Finally set $\gamma = \eta\varphi' : (Q, d) \rightarrow (\Lambda v \otimes \Lambda W, d)$. Since $H(\zeta)H(\varphi')\iota_Q = H(\varphi)H(\xi)\iota_Q = H(\varphi)[v \otimes 1] = [v] \cdot 1 = [v]H(\zeta)\iota_P = H(\zeta)([v] \cdot \iota_P)$ we have $H(\varphi')\iota_Q = [v] \cdot \iota_P$. Thus $H(\gamma)\iota_Q = [v \otimes 1]$.

Step 2: *Extension of γ to $\alpha : (Q \otimes N, d) \rightarrow (\Lambda v \otimes \Lambda W, d)$.*

Extend ξ to $\xi_N : (Q \otimes N, d) \rightarrow v \otimes (\Lambda W / \Lambda^{> m} W, \bar{d})$ by setting $\xi_N(Q \otimes a_n) = 0$, $n \geq 1$. In the diagram

$$\begin{array}{ccc} & & (Q, d) \\ & \nearrow \tau & \downarrow \cong \xi \\ (Q \otimes N, d) & \xrightarrow{\xi_N} & v \otimes (\Lambda W / \Lambda^{> m} W, \bar{d}) \end{array}$$

we may construct the morphism τ so that $\xi\tau \sim \xi_N$ (Proposition 6.4(i)). Moreover it is immediate from the proof of this proposition that we may suppose τ restricts to the identity in Q , because ξ_N and ξ coincide in Q . Thus

$$\alpha = \eta \circ \varphi' \circ \tau : (Q \otimes N, d) \rightarrow (\Lambda v \otimes \Lambda W, d)$$

restricts to γ in (Q, d) .

Step 3: *Construction of a homotopy from α to a morphism β with image in $v \otimes \Lambda W$.*

It is in this Step that we apply the hypothesis that $H(\theta)$ is locally conilpotent. More precisely, we establish

Lemma 31.14 *Suppose $(x_n, z_n)_{n \geq 0}$ is an infinite sequence of pairs of elements $x_n, z_n \in \Lambda W$ satisfying:*

$$\bar{d}z_n = 0 \quad \text{and} \quad \theta z_{n+1} = z_n + \bar{d}x_n, \quad n \geq 0.$$

Then there is an infinite sequence of elements $y_n \in \Lambda W$ such that

$$\bar{d}y_n = z_n \quad \text{and} \quad \theta y_{n+1} = y_n + x_n, \quad n \geq 0.$$

proof: Observe first that each $[z_n] \in \bigcap_k \text{Im } H(\theta)^k = 0$, since $[z_n] = H(\theta)[z_{n+1}] = H(\theta)^2[z_{n+2}] = \dots$. Thus the affine spaces $A_n = \bar{d}^{-1}(z_n)$ are non-void and finite dimensional. Affine maps

$$\longrightarrow A_{n+1} \xrightarrow{\alpha_n} A_n \longrightarrow \dots \xrightarrow{\alpha_0} A_0$$

are defined by $\alpha_n(y) = \theta y - x_n, \quad y \in A_{n+1}$. For each n this gives the infinite decreasing sequence of affine spaces

$$A_n \supset \text{Im } \alpha_n \supset \text{Im}(\alpha_n \circ \alpha_{n+1}) \supset \dots \supset \text{Im}(\alpha_n \circ \dots \circ \alpha_{n+k}) \supset \dots$$

For dimension reasons this sequence must stabilize at some $k(n) : \text{Im}(\alpha_n \circ \dots \circ \alpha_{n+p}) = \text{Im}(\alpha_n \circ \dots \circ \alpha_{n+k(n)})$ for $p \geq k(n)$. Put $E_n = \text{Im}(\alpha_n \circ \dots \circ \alpha_{n+k(n)})$. Then $\alpha_n(E_{n+1}) = E_n$ since, for p sufficiently large, $\alpha_n(E_{n+1}) = \alpha_n(\text{Im } \alpha_{n+1} \circ \dots \circ \alpha_{n+p}) = E_n$. Thus we may choose an infinite sequence of elements $y_n \in E_n$ such that $\alpha_{n+1}y_{n+1} = y_n, n \geq 0$. Thus $\theta(y_{n+1}) = y_n + x_n$. Since $E_n \subset A_n = \bar{d}^{-1}(z_n)$ we also have $\bar{d}y_n = z_n, n \geq 0$. □

We now complete Step 3 by constructing a homotopy H from α to a morphism β satisfying the stronger condition

$$\beta(Q \otimes a_0) \subset v \otimes \Lambda W \quad \text{and} \quad \beta(Q \otimes a_n) = 0, \quad n \geq 1. \tag{31.15}$$

For this, write $Q = \Lambda v \otimes \Lambda W \otimes M$, where M decomposes as the direct sum $M = \bigoplus_{k=0}^{\infty} M_k$ such that $d(M_0) = 0$ and $d(M_{k+1}) \subset \Lambda v \otimes \Lambda W \otimes M_{\leq k}$. Denote $\Lambda v \otimes \Lambda W \otimes M_k$ and $\Lambda v \otimes \Lambda W \otimes M_{<k}$ respectively by Q_k and $Q_{<k}$.

Now any linear map $g_k : M_k \otimes N \longrightarrow \Lambda v \otimes \Lambda W$ extends uniquely to a $\Lambda v \otimes \Lambda W$ -linear map $G_k : Q \otimes N \longrightarrow \Lambda v \otimes \Lambda W$ such that $G_k(M_i \otimes N) = 0, i \neq k$. A

sequence of linear maps, $g_k : M_k \otimes N \rightarrow \Lambda v \otimes \Lambda W$, determines in this way the $\Lambda v \otimes \Lambda W$ -linear map $G = \sum_{k=0}^{\infty} G_k : Q \otimes N \rightarrow \Lambda v \otimes \Lambda W$.

Suppose now by induction that $g_i, i < k$ of degree -1 are constructed so that $\alpha' = \alpha - \left(\sum_{i < k} dG_i + G_i d \right)$ satisfies condition (31.15) in $Q_{<k} \otimes N$. We shall

construct g_k so that $\alpha - \left(\sum_{i \leq k} dG_i + G_i d \right)$ satisfies (30.15) in $Q_{\leq k} \otimes N$. If (g_k)

is the infinite sequence constructed in this way then $\beta = \alpha - \left(\sum_{i=0}^{\infty} dG_i + G_i d \right)$

satisfies (31.15) because β restricts to $\alpha - \left(\sum_{i=0}^k dG_i + G_i d \right)$ in $Q_{\leq k} \otimes N$.

It remains to construct g_k , given α' . Define $\Lambda v \otimes \Lambda W$ -linear maps $f_n, q_n : Q_{\leq k} \rightarrow \Lambda W$ by the equations

$$\alpha'(\Phi \otimes a_n) = f_n \Phi + v(q_n \Phi), \quad n \geq 0.$$

The condition $d\alpha = \alpha d$ then implies

$$\bar{d}f_n = f_n d \quad \text{and} \quad \theta f_{n+1} - f_n = \bar{d}q_{n+1} + q_{n+1} d, \quad n \geq 0.$$

Recall now that we suppose $\alpha' = 0$ in $Q_{<k} \otimes a_n, n \geq 1$ and that $\alpha'(Q_{<k} \otimes a_0) \subset v \otimes \Lambda W$. Since $d : M_k \rightarrow Q_{<k}$ it follows from this that

$$f_n \circ d : M_k \rightarrow 0, \quad n \geq 0 \quad \text{and} \quad q_n \circ d : M_k \rightarrow 0, \quad n \geq 1.$$

Thus if $z \in M_k$ the equations above reduce to

$$\bar{d}f_n z = 0, \quad n \geq 0 \quad \text{and} \quad \theta f_{n+1} z - f_n z = \bar{d}q_{n+1} z, \quad n \geq 0.$$

We may thus apply Lemma 31.14 with $z_n = f_n z$ and $x_n = q_{n+1} z$ to find a sequence of elements $y_n \in \Lambda W$ such that

$$\bar{d}y_n = z_n \quad \text{and} \quad \theta y_{n+1} = y_n + x_n, \quad n \geq 0.$$

Now define $g_k : M_k \otimes N \rightarrow \Lambda W$ by setting $g_k(z \otimes a_n) = y_n$ where (y_n) is a sequence as above for z , and z runs through a basis of M_k . Then $\bar{d}g_k(z \otimes a_n) = f_n z$ and $\theta g_k(z \otimes a_{n+1}) = g_k(z \otimes a_n) + q_{n+1} z, n \geq 0, z \in M_k$. Moreover

$$[\alpha' - (dG_k + G_k d)](z \otimes a_n) = f_n z + v(q_n z) - \bar{d}g_k(z \otimes a_n) - v\theta g_k(z \otimes a_n) + v g_k(z \otimes a_{n-1})$$

where $a_{-1} = 0$. Thus the right hand side is zero for $n \geq 1$ and reduces to $v(q_k z - \theta g_k(z \otimes a_0))$ if $n = 0$. Since α' and α coincide in $Q_{<k} \otimes N$, the inductive step is complete.

Step 4: *Proof that $\text{cat}(\Lambda W, \bar{d}) \leq m$.*

Define a $(\Lambda W, \bar{d})$ -module structure in $(Q \otimes N, d)$ by setting

$$\Phi \cdot (z \otimes a_n) = \sum_{p=0}^{\infty} (-1)^p \binom{p+n}{p} (\theta^p \Phi) z \otimes a_{n+p}, \quad \Phi \in \Lambda W, \quad z \in Q.$$

(Since θ decreases degrees this series is a finite sum). By Step 3, $\beta : (Q \otimes N, d) \rightarrow v \otimes (\Lambda W, \bar{d})$ is a morphism of $(\Lambda v \otimes \Lambda W, d)$ -modules, vanishing on $Q \otimes a_n, n \geq 1$. It follows that β is a morphism of $(\Lambda W, \bar{d})$ -modules.

Next, let z_Q be a cocycle in Q representing the class ι_Q of Step 1 and define a morphism $\lambda : v \otimes (\Lambda W, \bar{d}) \rightarrow (Q \otimes N, d)$ of $(\Lambda W, \bar{d})$ -modules by setting $\lambda(v \otimes \Phi) = (-1)^{\deg \Phi} \Phi \cdot z_Q$. We shall show that $\beta \lambda = id$.

Since β and λ are ΛW -linear it is enough to show that $\beta \lambda(v \otimes 1) = v \otimes 1$. But $\beta \lambda(v \otimes 1) = tv \otimes 1$, some $t \in \mathbb{k}$, for reasons of degree. Moreover $\beta \lambda(v \otimes 1) = \beta z_Q$ differs from αz_Q by a coboundary in $\Lambda v \otimes \Lambda W$, because $\beta \sim \alpha$ (Step 3). Since α restricts to γ in Q (Step 2) and since $H(\gamma)\iota_Q = [v \otimes 1]$ (Step 1) it follows that $t[v \otimes 1] = [v \otimes 1]$ in $H(\Lambda v \otimes \Lambda W, d)$. Since $(\Lambda v \otimes \Lambda W, d)$ is a minimal Sullivan algebra $v \otimes 1$ cannot be a coboundary; i.e. $[v \otimes 1] \neq 0$ and $t = 1$. Thus $\beta \lambda(v \otimes 1) = v \otimes 1$ and $\beta \lambda = id$.

Finally, recall the $(\Lambda v \otimes \Lambda W, d)$ -quasi-isomorphism

$$\xi : (Q, d) \simeq v \otimes (\Lambda W / \Lambda^{>m} W, \bar{d})$$

defined at the start of the proof of the proposition. It extends to the quasi-isomorphism

$$\xi \otimes id : (Q \otimes N, d) \rightarrow v \otimes (\Lambda W / \Lambda^{>m} W, \bar{d}) \otimes (N, 0)$$

since $\xi(vQ) = v \cdot \xi(Q) = 0$. Moreover we can make $v \otimes (\Lambda W / \Lambda^{>m} W, \bar{d}) \otimes (N, 0)$ into a $(\Lambda W, \bar{d})$ -module, and ξ into a morphism of $(\Lambda W, \bar{d})$ -modules, by setting

$$\Phi \cdot (v \otimes \Psi \otimes a_n) = (-1)^{\deg \Phi} \sum_{p=0}^{\infty} (-1)^p \binom{p+n}{p} (\theta^p \Phi) \Psi \otimes a_{n+p}.$$

Thus altogether we have the diagram of morphisms of $(\Lambda W, \bar{d})$ -modules

$$\begin{array}{ccccc} v \otimes (\Lambda W, \bar{d}) & \xrightarrow{\lambda} & (Q \otimes N, d) & \xrightarrow{\beta} & v \otimes (\Lambda W, \bar{d}) \\ & & \downarrow \simeq \xi \otimes id & & \\ & & v \otimes (\Lambda W / \Lambda^{>m} W, \bar{d}) \otimes (N, 0), & & \end{array}$$

with $\beta \lambda = id$.

Since $\Lambda v \otimes \Lambda W$ is a minimal Sullivan algebra, $\text{Im } d \subset 1 \otimes \Lambda^{\geq 2} W + v \otimes \Lambda^+ W$. Thus θ preserves $\Lambda^+ W$. It follows that with respect to the module action just defined,

$$W \cdot (v \otimes \Lambda W / \Lambda^{>m} W \otimes N) \subset v \otimes \Lambda^+ W / \Lambda^{>m} W \otimes N.$$

Hence $\Lambda^{>m}W \cdot (v \otimes \Lambda W / \Lambda^{>m}W \otimes N) = 0$. Now the Corollary to Hess' theorem 29.9 asserts that $\text{cat}(\Lambda W, \bar{d}) \leq m$. \square

proof of Theorem 31.11: Recall that V is equipped with a basis (v_i) . Dividing by the elements v_1, \dots, v_{i-1} gives a quotient Sullivan algebra of the form $(\Lambda V_i \otimes \Lambda W, D_i)$ in which v_i, v_{i+1}, \dots project to a basis of V_i . Moreover the Mapping theorem 29.5 asserts that

$$\text{cat}(\Lambda V_i \otimes \Lambda W, D_i) \geq \text{cat}(\Lambda V_{i+1} \otimes \Lambda W, D_{i+1}) \geq \dots \geq \text{cat}(\Lambda W, \bar{d}) .$$

Thus Theorem 31.11 follows from the assertion:

If $x_i \in L_{\text{even}}$ and if $\text{ad } x_i$ is locally nilpotent and $H(\theta_i)$ is locally conilpotent, then

$$\text{cat}(\Lambda V_i \otimes \Lambda W, D_i) \geq \text{cat}(\Lambda V_{i+1} \otimes \Lambda W, D_{i+1}) + 1 .$$

To verify this, simplify notation by writing $v_i = v, V_{i+1} = U, \theta_i = \theta_v$ and $x_i = x$. Denote D_i by D and D_{i+1} by \bar{D} . Thus the Sullivan algebra $(\Lambda V_i \otimes \Lambda W, D_i)$ has the form $(\Lambda v \otimes \Lambda U \otimes \Lambda W, D)$. The homotopy Lie algebra of $(\Lambda v \otimes \Lambda U, D)$ is the subspace $I \subset L$ spanned by the $x_j, j \geq i$. In particular $\text{ad } x : I \rightarrow I$ is the restriction of $\text{ad } x_i : L \rightarrow L$ and hence is locally nilpotent.

Since x has even degree, v has odd degree. Thus the differential in $\Lambda v \otimes \Lambda U \otimes \Lambda W$ is given by $Dv = 0$ and

$$D(1 \otimes \Phi) = 1 \otimes \bar{D}\Phi + v \otimes \theta\Phi , \quad \Phi \in \Lambda U \otimes \Lambda W ,$$

where θ is a derivation in $(\Lambda U \otimes \Lambda W, \bar{D})$. Lemma 31.9 asserts that $H(\theta)$ is locally conilpotent, and thus Proposition 31.13 applies to give $\text{cat}(\Lambda v \otimes \Lambda U \otimes \Lambda W, D) \geq \text{cat}(\Lambda U \otimes \Lambda W, \bar{D}) + 1$. \square

(e) Examples.

Example 1 *The fibration $p : S^{4m+3} \rightarrow \mathbb{H}P^m$.*

The unit sphere S^3 of the quaternions \mathbb{H} acts freely by right multiplication on the unit sphere S^{4m+3} of \mathbb{H}^{m+1} ($\cong \mathbb{R}^{4m+4}$). This is the action of a classical principal S^3 bundle (§2(a)) $p : S^{4m+3} \rightarrow \mathbb{H}P^m$, with base space the quaternionic projective m -space.

The long exact rational homotopy sequence for this fibration reduces to

$$\pi_{4m+3}(S^{4m+3}) \otimes \mathbb{Q} \xrightarrow{\cong} \pi_{4m+3}(\mathbb{H}P^m) \otimes \mathbb{Q} \quad \text{and} \quad \pi_4(\mathbb{H}P^m) \otimes \mathbb{Q} \xrightarrow{\cong} \pi_3(S^3) \otimes \mathbb{Q} .$$

Thus $\dim \pi_*(\mathbb{H}P^m) \otimes \mathbb{Q} < \infty$ and $\dim \pi_{\text{odd}}(\mathbb{H}P^m) \otimes \mathbb{Q} = 1$. Moreover, the holonomy representation is automatically locally nilpotent (but not trivial) since the fibre has finite rational homology.

Thus all the hypotheses but one of Theorem 31.10 are satisfied: $\partial_* \otimes \mathbb{Q} \neq 0$. Since $\text{cat}_0 S^{4m+3} < \text{cat}_0 S^3 + \dim \pi_{\text{odd}}(\mathbb{H}P^m) \otimes \mathbb{Q}$ the conclusion of the theorem fails too, which shows that the hypothesis $\partial_* \otimes \mathbb{Q} = 0$ is necessary. (Note, however that it intervenes only at the end, in Step 4, of the proof of Proposition 31.13). \square

Example 2 *The fibration associated with $S^3 \vee S^3 \rightarrow S^3$.*

Convert projection from $S^3 \vee S^3$ to the first factor to a fibration $p : X \rightarrow S^3$ with $X \simeq S^3 \vee S^3$. Since p is not a rational homology equivalence the fibre, F , has non-trivial rational homology and so $\text{cat}_0 F \geq 1 = \text{cat}_0 X$, and the conclusion of Theorem 31.10 fails.

Here all the hypotheses hold, however, except for the hypothesis that the holonomy representation is locally nilpotent. This must therefore fail, and the example shows it is a necessary hypothesis. \square

Example 3 *Derivations in commutative cochain algebras.*

Suppose θ is a derivation of even (negative) degree in a commutative cochain algebra (A, d_A) such that $A^0 = \mathbb{k}$ and $H^1(A) = 0$. Then we may construct the commutative cochain algebra $(\Lambda v \otimes A, d)$, with $\text{deg } v + \text{deg } \theta = 1$ by setting $dv = 0$ and $da = d_A a + v \otimes \theta a$, $a \in A$.

Now let $(\Lambda W, \bar{d})$ be a minimal model of (A, d) . Then $(\Lambda v \otimes A, d)$ has a Sullivan model of the form $(\Lambda v \otimes \Lambda W, d)$ with $d\Phi = 1 \otimes \bar{d}\Phi + v \otimes \theta'\Phi$. If $(\Lambda v \otimes \Lambda W, d)$ is not a minimal Sullivan algebra then θ' restricts to a non-zero Gottlieb element $W^{\text{deg } v-1} \rightarrow \mathbb{k}$ and Proposition 29.8(ii) asserts that $\text{cat}(\Lambda W, \bar{d}) = \infty$. On the other hand, the isomorphism $H(\Lambda W, \bar{d}) \cong H(A, d_A)$ identifies $H(\theta')$ with $H(\theta)$. Thus if $\bigcap_k \text{Im } H(\theta)^k = 0$ we can apply Proposition 31.13 to conclude that

$$\text{cat}(\Lambda W, \bar{d}) \text{ is } \begin{cases} \leq \text{cat}(\Lambda v \otimes \Lambda W, d) - 1 & , \text{ if } (\Lambda v \otimes \Lambda W, d) \text{ is minimal.} \\ \infty & , \text{ otherwise.} \end{cases}$$

An interesting special case of the above is an arbitrary $\mathbb{k}[\theta]$ -module M concentrated in degrees ≥ 2 , from which we construct (A, d_A) by setting $A = \mathbb{k} \oplus M$, $d_A = 0$ and $M \cdot M = 0$. In this case if θ is locally conilpotent then

$$\text{cat}(\Lambda v \otimes \Lambda W, d) = 2 .$$

In fact since $(\Lambda W, \bar{d}) \simeq (A, 0)$ and $\text{nil } A = 1$ it follows that $\text{cat}(\Lambda W, \bar{d}) = 1$ (Proposition 29.3) and hence $\text{cat}(\Lambda v \otimes \Lambda W, d) \geq 2$. On the other hand, $(\Lambda v \otimes \Lambda W, d) \xrightarrow{\simeq} (\Lambda v \otimes A, d)$ and $\text{nil}(\Lambda v \otimes A) = 2$, so $\text{cat}(\Lambda v \otimes \Lambda W, d) \leq 2$. \square

Example 4 *A fibration $X \rightarrow \mathbb{C}P^m$ with fibre S^3 and $\text{cat}_0 X = 2$.*

Let S^1 act on S^{2m+1} by complex multiplication: S^1 is the unit circle of \mathbb{C} and S^{2m+1} is the unit sphere in \mathbb{C}^{m+1} . This is the action of a principal S^1 -bundle, $S^{2m+1} \rightarrow \mathbb{C}P^m$ (§2(d)). For $m = 1$ we have the action of S^1 on S^3 and the associated bundle (§2(e))

$$p : X = S^3 \times_{S^1} S^{2m+1} \rightarrow \mathbb{C}P^m$$

is a Serre fibration with fibre S^3 .

Since $\pi_*(\mathbb{C}P^m) \otimes \mathbb{Q}$ is concentrated in degrees 2 and $2m + 1$ it follows for degree reasons that the rational connecting homomorphism is zero. Since the fibre has

finite dimensional homology the holonomy representation is by locally nilpotent transformations. Thus Theorem 31.10 applies and gives $\text{cat}_0 X \geq \text{cat}_0 S^3 + 1 = 2$.

But we may also regard X as the total space of a Serre fibration $X \rightarrow S^2$ with fibre S^{2m+1} , so that $\text{cat}_0 X \leq 2$ (Proposition 30.7). Altogether we have $\text{cat}_0 X = 2$. □

(f) Iterated Lie brackets.

Let L_X be the homotopy Lie algebra of a simply connected topological space X with rational homology of finite type. Apply Theorem 31.10 to the fibration $X \xrightarrow{id} X$ to obtain

Theorem 31.16 *If $\text{cat}_0 X = m$ there are at most m linearly independent elements $x_i \in (L_X)_{\text{even}}$ such that $\text{ad } x_i$ is locally nilpotent.*

In particular if $\text{cat}_0 X$ is finite then for each non-zero $x \in (L_X)_{\text{even}}$ of sufficiently large degree there is some $y \in L_X$ such that the iterated Lie brackets $[x, [x[x, \dots, [x, y] \dots]]]$ are all non-zero.

Similarly, if L is the homotopy Lie algebra of a minimal Sullivan algebra $(\Lambda V, d)$ with $V = V^{\geq 2}$ a graded vector space of finite type, then Theorem 31.11 applied to the relative Sullivan algebra $(\Lambda V, d) \xrightarrow{id} (\Lambda V, d)$ gives

Theorem 31.17 *If $\text{cat}(\Lambda V, d) = m$ there are at most m linearly independent elements $x_i \in L_{\text{even}}$ such that $\text{ad } x_i$ is locally nilpotent.*

Example 1 *A space with $e_0 X = 2$ and $\text{cat}_0 X = \infty$.*

In Example 6, §12(d), we constructed a minimal Sullivan model $(\Lambda V, d)$ such that $d : V \rightarrow \Lambda^3 V$ and every cocycle in $\Lambda^{\geq 3} V$ is a coboundary. Moreover $V = V^{\geq 2}$ and has finite type and it is immediate from the construction that we may choose V^{odd} to be infinite dimensional.

Because every cocycle in $\Lambda^{\geq 3} V$ is a coboundary, $e(\Lambda V, d) \leq 2$. Because there are no coboundaries in $\Lambda^2 V$, $e(\Lambda V, d) = 2$. Because $d : \Lambda^k V \rightarrow \Lambda^{k+3} V$ the Milnor-Moore spectral sequence collapses at the E_3 -term. On the other hand, the homotopy Lie algebra is abelian, because the quadratic part of d is zero. Thus Theorem 31.18 shows that $\text{cat}(\Lambda V, d) = \infty$.

In particular, if X is the geometric realization of $(\Lambda V, d)$ (§17) then

$$\text{cat}_0 X = \text{cat}(\Lambda V, d) = \infty \quad \text{and} \quad e_0 X = e(\Lambda V, d) = 2 . \quad \square$$

Finally recall that the construction of $(\Lambda V, d)$ begins with a graded subspace $Z \subset V$ such that $d(Z) = 0$, and that $V = Z \oplus W$ with d injective in W . Let I be the ideal $\Lambda^{\geq 2} V \oplus W$, and let (A, d) be the sub cochain algebra given by $A = \bigoplus_k \Lambda^{2k} V$. The inclusion $(A, d) \rightarrow (I \oplus \mathbb{k}, d)$ is a quasi-isomorphism.

Moreover, dividing by $(A^+)^2$ and by a complement of $\ker d$ in $\Lambda^2 V$ defines a quasi-isomorphism $(A, d) \xrightarrow{\sim} H(A)$ and shows $H^+(A) \cdot H^+(A) = 0$.

The surjection $(\Lambda V, d) \rightarrow (\Lambda V/I, d)$ is a commutative representative for a continuous map $q : X \rightarrow \bigvee_{\alpha} S^{n_{\alpha}}$, where $S^{n_{\alpha}}$ corresponds to a basis element of Z with degree n_{α} . Moreover $(I \oplus \mathbb{k})$ is a commutative model for the cofibre of q as follows from a simple calculation using the Remark after Proposition 13.6. In view of the observations above $I \oplus \mathbb{k}$ is the commutative model of a wedge of spheres (Example of §12(a)) and so we have constructed a cofibration

$$\bigvee_{\alpha} S_{\mathbb{Q}}^{n_{\alpha}} \rightarrow X \rightarrow \bigvee_{\beta} S_{\mathbb{Q}}^{n_{\beta}} . \quad \square$$

Exercises

1. Let $F \rightarrow X \rightarrow S^{2n+1}$ be a fibration. Suppose that F has the homotopy type of a simply connected CW complex of finite type and that $H_*(\Omega S^{2n+1})$ acts trivially on $H_*(F)$. Show that the induced map $H_*(F; \mathbb{Q}) \rightarrow H_*(X; \mathbb{Q})$ is injective.

2. Let $f : X = (S^3 \times S^3) \vee (S^5 \times S^5) \rightarrow S^3$ be the continuous map whose restriction to $S^3 \times S^3$ is projection onto the first factor, and that restricts to the trivial map on $S^5 \times S^5$. Denote by F the homotopy fibre of f . Prove that $\text{cat} X = \text{cat}_0 F = 2$. Prove that $H_*(F; \mathbb{Z})$ is not a free $H_*(\Omega S^3)$ -module, nor a locally nilpotent one.

3. Let $p : X \rightarrow S^{2n+1}$ be a fibration with simply connected fibre. If $\pi_{2n+1}(S^{2n+1})$ acts locally nilpotently on $H_*(F; k)$ and if $H_*(X; k)$ is finite dimensional, prove that $H_*(F; k)$ is finite dimensional.

4. We consider the rational fibration $\bigvee_{i=1}^n S_0^r \rightarrow X \rightarrow S_0^{2n+1}$ whose commutative model is given by $(\wedge x \otimes (1, a_1, \dots, a_n), d)$ with $a_i a_j = 0$ and $d(a_i) = x a_{i-1}$. Prove that: $ad_x(a_i) = a_{i+1}, \dots, ad_x(a_n) = 0$. Using Jessup's result, prove that $\text{cat}_0 X = 2$.

5. Prove that the fibration $F \rightarrow E \rightarrow S^{2n+1}$, $n \geq 1$, admits a Lie model that is a short exact sequence of differential graded Lie algebras

$$0 \rightarrow \mathbb{L}(T(x) \otimes W) \rightarrow \mathbb{L}(\mathbb{Q}x \oplus W) \rightarrow \mathbb{L}(x) \rightarrow 0 .$$

Interpret the holonomy operation as multiplication by x .

6. Denote by E_X the subspace of L_X generated by the Engels elements of $\pi_* X \otimes \mathbb{Q}$. Prove that $G^{\mathbb{Q}}(X) \subset E_X$. Construct an example with $G^{\mathbb{Q}}(X) \neq E_X \neq L_X$.

7. Let $F \xrightarrow{j} E \rightarrow B$ be a fibration with $\dim \pi_*(B) \otimes \mathbb{Q} < \infty$ and $\ker[\pi_*(j) \otimes \mathbb{Q}]^{\text{even}} = 0$. Suppose that $H_*(\Omega B; \mathbb{Q})$ acts locally nilpotently in $H_*(F; \mathbb{Q})$, and prove that

$$\text{cat}_0(E) \geq \text{cat}_0(F) + \dim \pi_{\text{odd}}(B) \otimes \mathbb{Q} - \dim[\ker \pi_j \otimes \mathbb{Q}] \geq \dim \pi_{\text{odd}}(B) \otimes \mathbb{Q} .$$

Part VI

**The Rational Dichotomy:
Elliptic and Hyperbolic Spaces
and
Other Applications**

32 Elliptic spaces

In this section the ground ring is an arbitrary field \mathbb{k} of characteristic zero.

A simply connected topological space X is called *rationally elliptic* if it satisfies the two conditions:

$$\dim H_*(X; \mathbb{Q}) < \infty \quad \text{and} \quad \dim \pi_*(X) \otimes \mathbb{Q} < \infty .$$

By analogy a minimal Sullivan algebra $(\Lambda V, d)$ is *elliptic* if both $H(\Lambda V, d)$ and V are finite dimensional. If $(\Lambda V, d)$ is a minimal Sullivan model for a simply connected space X then

$$H^*(\Lambda V, d) \cong H^*(X; \mathbb{k}) \quad \text{and} \quad V \cong \text{Hom}_{\mathbb{Z}}(\pi_*(X), \mathbb{k})$$

(Theorem 10.1 and Theorem 15.11). Thus X is rationally elliptic if and only if its minimal Sullivan models are elliptic.

Rationally elliptic spaces occur naturally; for instance the classical homogeneous spaces G/K of differential geometry are rationally elliptic. However, the ‘generic’ space with finite homology is not rationally elliptic; for example, in this section we shall see that the homotopy groups of rationally elliptic spaces satisfy very stringent restrictions.

Indeed, suppose X is rationally elliptic and let n_X be the maximum degree such that $H^{n_X}(X; \mathbb{Q}) \neq 0$. In Theorem 32.6 we shall show that if (x_i) is a basis of $\pi_{\text{odd}}(X) \otimes \mathbb{Q}$ and if (y_j) is a basis for $\pi_{\text{even}}(X) \otimes \mathbb{Q}$ then

- $\sum \deg x_i \leq 2n_X - 1 \quad \text{and} \quad \sum \deg y_j \leq n_X,$

so that, in particular,

- $\pi_i(X) \otimes \mathbb{Q} = 0, \quad i \geq 2n_X \quad \text{and} \quad \dim \pi_*(X) \otimes \mathbb{Q} \leq n_X.$

We also obtain a formula for n_X :

- $n_X = \sum_i \deg x_i - \sum_j (\deg y_j - 1).$

Finally, in Proposition 32.10 we shall show that

- $\dim \pi_{\text{odd}}(X) \otimes \mathbb{Q} - \dim \pi_{\text{even}}(X) \otimes \mathbb{Q} \geq 0 \quad \text{and} \quad \sum_i (-1)^i \dim H^i(X; \mathbb{Q}) \geq 0,$
with equality holding on the left if and only if it fails on the right.

These various inequalities have interesting geometric properties. For example

- *If X is rationally elliptic then*

$$\dim \pi_{\text{odd}}(X) \otimes \mathbb{Q} \leq \text{cat}_0 X ,$$

and (Allday-Halperin [3])

- If an r -torus acts smoothly and freely on a rationally elliptic closed manifold X then

$$r \leq \dim \pi_{\text{odd}}(X) \otimes \mathbb{Q} - \dim \pi_{\text{even}}(X) \otimes \mathbb{Q} .$$

In particular, if $X = G/K$ with G and K compact simply connected Lie groups then

$$r \leq \text{rank } G - \text{rank } K .$$

Most of these results are obtained by reduction to the case of *pure* Sullivan algebras $(\Lambda V, d)$; these are the finitely generated Sullivan algebras in which $d = 0$ in V^{even} and $d : V^{\text{odd}} \rightarrow \Lambda V^{\text{even}}$. Cochain algebras of this special form were introduced by H. Cartan in [33] for the computation of the cohomology of homogeneous spaces; in retrospect these can be seen to be the first examples of Sullivan algebras. The properties of pure Sullivan algebras as established in (a) and (d) below are largely due to Koszul [102], and indeed they are often referred to as Koszul complexes.

This section is organized as follows:

- (a) Pure Sullivan algebras.
- (b) Characterizations of elliptic Sullivan algebras.
- (c) Exponents and formal dimension.
- (d) Euler-Poincaré characteristic.
- (e) Rationally elliptic topological spaces.
- (f) Decomposability of the loop spaces of rationally elliptic topological spaces.

(a) Pure Sullivan algebras.

Given a Sullivan algebra $(\Lambda V, d)$, write $V^{\text{even}} = Q$ and $V^{\text{odd}} = P$, so that $\Lambda V = \Lambda Q \otimes \Lambda P$. Recall that $(\Lambda V, d)$ is called *pure* if V is finite dimensional and if $d = 0$ in Q and $d(P) \subset \Lambda Q$. If $(\Lambda V, d)$ is a pure Sullivan algebra, then d is homogeneous of degree -1 with respect to wordlength in P :

$$0 \longleftarrow \Lambda Q \longleftarrow \Lambda Q \otimes P \longleftarrow \cdots \longleftarrow \Lambda Q \otimes \Lambda^k P \longleftarrow \cdots .$$

Thus if $H_k(\Lambda V, d)$ is the subspace representable by cocycles in $\Lambda Q \otimes \Lambda^k P$ we have $H(\Lambda V, d) = \bigoplus_k H_k(\Lambda V, d)$; this will be called the *lower grading* of $H(\Lambda V, d)$.

Note that $d(\Lambda Q \otimes P) = \Lambda Q \cdot d(P)$ is the ideal in the polynomial algebra ΛQ generated by $d(P)$. Thus

$$H_0(\Lambda V, d) = \Lambda Q / \Lambda Q \cdot d(P) .$$

Proposition 32.1 *If $(\Lambda V, d)$ is a pure Sullivan algebra then $H(\Lambda V, d)$ is finite dimensional if and only if $H_0(\Lambda V, d)$ is finite dimensional.*

proof: Since ΛV is a finitely generated module over the (noetherian) polynomial algebra ΛQ any submodule is also finitely generated. Since $d(\Lambda Q) = 0$, $\ker d$ is a ΛQ -submodule of ΛV ; hence it is finitely generated. Thus $H(\Lambda V, d)$ is finitely generated as a module over the subalgebra $H_0(\Lambda V, d)$. The Proposition follows. \square

Consider again a pure Sullivan algebra $(\Lambda V, d)$ as above and suppose $2a_1, \dots, 2a_q$ are the degrees of a basis (y_j) of Q and $2b_1 - 1, \dots, 2b_p - 1$ are the degrees of a basis (x_i) of P . (Thus $\dim Q = q$ and $\dim P = p$).

Proposition 32.2 *Suppose $H(\Lambda V, d)$ is finite dimensional and let r and n be the maximum integers such that $H^n(\Lambda V, d) \neq 0$ and $H_r(\Lambda V, d) \neq 0$. Then*

- (i) $H^n(\Lambda V, d)$ is a one-dimensional subspace of $H_r(\Lambda V, d)$.
- (ii) $r = \dim P - \dim Q$; in particular, $\dim P \geq \dim Q$ and equality holds if and only if $H(\Lambda V, d) = H_0(\Lambda V, d)$.
- (iii) $n = \sum_i (2b_i - 1) - \sum_j (2a_j - 1)$.

proof: Define a graded vector space \bar{Q} by $\bar{Q}^i = Q^{i+1}$ and denote the correspondence between elements by $\bar{y} \leftrightarrow y$. Extend $(\Lambda V, d)$ to a pure Sullivan algebra $(\Lambda Q \otimes \Lambda(P \otimes \bar{Q}), d)$ by setting $d\bar{y} = y, \bar{y} \in \bar{Q}$. This can be written as $(\Lambda Q \otimes \Lambda\bar{Q} \otimes \Lambda P, d)$ and $(\Lambda Q \otimes \Lambda\bar{Q}, d)$ is contractible (§12(b)). Thus division by Q and \bar{Q} defines a quasi-isomorphism $(\Lambda Q \otimes \Lambda\bar{Q} \otimes \Lambda P, d) \xrightarrow{\cong} (\Lambda P, 0)$, whence

$$H_s^m(\Lambda Q \otimes \Lambda P \otimes \Lambda\bar{Q}, d) \cong (\Lambda^s P)^m .$$

Let k be the largest integer such that $H_r^k(\Lambda V, d) \neq 0$. It is easy to construct an ideal $I \subset \Lambda Q \otimes \Lambda P$ such that: I is preserved by $d, H(I, d) = 0, I = \bigoplus_s I \cap (\Lambda Q \otimes \Lambda^s P)$ and $I \supset (\Lambda Q \otimes \Lambda^s P)^\ell$ if $s > r$ or if $s = r$ and $\ell > k$. Let (A, \bar{d}) be the quotient cochain algebra $(\Lambda Q \otimes \Lambda P / I, \bar{d})$ and note that $A = \bigoplus_s A_s$, where A_s is the image of $\Lambda Q \otimes \Lambda^s P$, and that $A^+ \cdot A_r^k \subset A_0^+ \cdot A_r^k + A_{>r} = 0$. By Lemma 14.2 the quasi-isomorphism $\varrho : (\Lambda Q \otimes \Lambda P, d) \rightarrow (A, \bar{d})$ extends to a quasi-isomorphism

$$(\varrho \otimes id) : (\Lambda Q \otimes \Lambda P \otimes \Lambda\bar{Q}, d) \xrightarrow{\cong} (A \otimes \Lambda\bar{Q}, \bar{d}) ,$$

where $\bar{d}\bar{y} = \varrho dy$. Thus if $H_s(A \otimes \Lambda\bar{Q})$ is the space represented by cocycles in $\bigoplus_{i+j=s} A_i \otimes \Lambda^j \bar{Q}$, we have

$$H_s^m(A \otimes \Lambda\bar{Q}) \cong H_s^m(\Lambda Q \otimes \Lambda P \otimes \Lambda\bar{Q}) \cong (\Lambda^s P)^m .$$

Now let $a \in A_r^k$ be a cocycle representing a non-zero cohomology class. Since $A^+ \cdot A_r^k = 0$, and since $\bar{d}\bar{y}_i \in A^+, a \otimes \bar{y}_1 \wedge \dots \wedge \bar{y}_q$ is a cocycle in $A \otimes \Lambda\bar{Q}$. It

cannot be a coboundary, since $(A \otimes \Lambda \bar{Q})_{r+q+1} = 0$. Thus it represents a non-zero cohomology class of lower degree $r + q$, which is obviously the maximum lower degree possible. Since $\dim P = p$ this gives an inclusion

$$H_r^k(A) \otimes \bar{y}_1 \wedge \cdots \wedge \bar{y}_q \subset H_{r+q}(A \otimes \Lambda \bar{Q}) \cong \Lambda^p P .$$

In particular $r + q = p$ and $r = p - q = \dim P - \dim Q$. Since $\dim \Lambda^p P = 1$ we have $\dim H_r^k(A) = 1$ and, if x_1, \dots, x_p is a basis of P ,

$$k = \sum_i \deg x_i - \sum_j \deg \bar{y}_j = \sum_i (2b_i - 1) - \sum_j (2a_j - 1) .$$

Finally, let N be the largest degree such that $H^N(A \otimes \Lambda \bar{Q}) \neq 0$ and let $J \subset \Lambda Q \otimes \Lambda P$ be an ideal of the form $(\Lambda Q \otimes \Lambda P)^{>n} \oplus J^n$ chosen so that $H(J, d) = 0$. Set $B = \Lambda Q \otimes \Lambda P / J$. Then the identical argument gives

$$H^n(B) \otimes \bar{y}_1 \wedge \cdots \wedge \bar{y}_q \subset H^N(B \otimes \Lambda \bar{Q}) \cong \Lambda^p P .$$

This shows that $n = k$, which completes the proof. □

Finally, let Q be a finite dimensional graded vector space concentrated in even degrees. A *regular sequence* in the polynomial algebra ΛQ is a sequence of elements u_1, \dots, u_m in $\Lambda^+ Q$ such that u_1 is not a zero divisor in ΛQ and (for $i \geq 2$) the image of u_i is not a zero divisor in the quotient graded algebra $\Lambda Q / (u_1, \dots, u_{i-1})$.

On the other hand any sequence u_1, \dots, u_m of elements in $\Lambda^+ Q$ determines the pure Sullivan algebra $(\Lambda Q \otimes \Lambda(x_1, \dots, x_m), d)$ defined by $dx_i = u_i$ and we have

Proposition 32.3 *The sequence u_1, \dots, u_m is regular if and only if $H_+(\Lambda Q \otimes \Lambda(x_1, \dots, x_m), d) = 0$.*

proof: We show first that if $H_+(\Lambda Q \otimes \Lambda(x_1, \dots, x_{m-1})) = 0$ and if u_1, \dots, u_{m-1} is a regular sequence then $H_+(\Lambda Q \otimes \Lambda(x_1, \dots, x_m), d) = 0$ if and only if u_1, \dots, u_m is a regular sequence. Denote by I the ideal in ΛQ generated by u_1, \dots, u_{m-1} . Under the hypotheses above a quasi-isomorphism $\varphi : (\Lambda Q \otimes \Lambda(x_1, \dots, x_{m-1}), d) \rightarrow \Lambda Q / I$ is defined by: $\varphi x_i = 0$ and, for $a \in \Lambda Q$, φa is the image of a in $\Lambda Q / I$. Then (Lemma 14.2) $\varphi \otimes id : (\Lambda Q \otimes \Lambda(x_1, \dots, x_m), d) \xrightarrow{\cong} (\Lambda Q / I \otimes \Lambda x_m, \bar{d})$ is a quasi-isomorphism, where $\bar{d}x_m = \varphi u_m$.

Let $K \subset \Lambda Q / I$ be the subspace of elements u such that $u \cdot \varphi u_m = 0$. Then $H(\Lambda Q / I \otimes \Lambda x_m, \bar{d}) = \Lambda Q / (u_1, \dots, u_m) \oplus (K \otimes x_m)$. Since the isomorphism $H(\varphi \otimes id)$ preserves lower degrees (clearly) we have $H_{\geq 2}(\Lambda Q \otimes \Lambda(x_1, \dots, x_m), d) = 0$ and $H_1(\Lambda Q \otimes \Lambda(x_1, \dots, x_m)) \cong K \otimes x_m$. Since $K = 0$ if and only if u_1, \dots, u_m is a regular sequence, this is equivalent to $H_+(\Lambda Q \otimes \Lambda(x_1, \dots, x_m)) = 0$.

Finally, if u_1, \dots, u_m is a regular sequence so is u_1, \dots, u_{m-1} and so by induction $H_+(\Lambda Q \otimes \Lambda(x_1, \dots, x_{m-1})) = 0$. Thus $H_+(\Lambda Q \otimes \Lambda(x_1, \dots, x_m)) = 0$.

Conversely, suppose $H_+(\Lambda Q \otimes \Lambda(x_1, \dots, x_m)) = 0$. For any k , let $z \in \Lambda Q \otimes \Lambda^k(x_1, \dots, x_{m-1})$ be a cocycle representing a non-zero class of least degree in $H_k(\Lambda Q \otimes \Lambda(x_1, \dots, x_{m-1}))$. A simple calculation shows z is not a coboundary in $\Lambda Q \otimes \Lambda(x_1, \dots, x_m)$. Thus $k = 0$ and $H_+(\Lambda Q \otimes \Lambda(x_1, \dots, x_{m-1})) = 0$. By induction, u_1, \dots, u_{m-1} is a regular sequence and so by the argument above, so is u_1, \dots, u_m . \square

(b) Characterization of elliptic Sullivan algebras.

Suppose $(\Lambda V, d)$ is a Sullivan algebra in which V is finite dimensional. Write $V^{\text{odd}} = P$ and $V^{\text{even}} = Q$, so that $\Lambda V = \Lambda Q \otimes \Lambda P$ is the tensor product of the polynomial algebra, ΛQ and the exterior algebra, ΛP . Then bigrade ΛV by setting $(\Lambda Q \otimes \Lambda^k P)^n = (\Lambda V)^{k+n, -k}$ and filter ΛV by setting $F^p(\Lambda V) = (\Lambda V)^{\geq p, *}$.

Since the differential increases degree by one and decreases the wordlength in P by at most one it preserves the filtration. Thus $(\Lambda V, d)$ is a filtered cochain algebra, with which there is then a naturally associated spectral sequence of cochain algebras, called the *odd spectral sequence* for the Sullivan algebra.

It is immediate from the definition that the first term of the odd spectral sequence has the form

$$(E_0, d_0) = (\Lambda V, d_\sigma) ,$$

where d_σ is characterized by:

$$d_\sigma(Q) = 0 , d_\sigma : P \longrightarrow \Lambda Q \quad \text{and} \quad d - d_\sigma : P \longrightarrow \Lambda Q \otimes \Lambda^+ P .$$

Thus $(\Lambda V, d_\sigma)$ is a pure Sullivan algebra and (in the notation of §32(a))

$$E_1^{p,q} = H_{-q}^{p+q}(\Lambda V, d_\sigma) .$$

We call $(\Lambda V, d_\sigma)$ the *pure Sullivan algebra associated with $(\Lambda V, d)$* .

Note also that $F^p((\Lambda V)^n) = 0, p > n + \dim P$. Thus the odd spectral sequence is convergent to $H(\Lambda V, d)$.

Proposition 32.4 *Let $(\Lambda V, d)$ be a minimal Sullivan algebra in which V is finite dimensional and $V = V^{\geq 2}$. Then the following conditions are equivalent:*

- (i) $\dim H(\Lambda V, d_\sigma) < \infty$.
- (ii) $\dim H(\Lambda V, d) < \infty$.
- (iii) $\text{cat}(\Lambda V, d) < \infty$.

proof: Since the odd spectral sequence converges from $H(\Lambda V, d_\sigma)$ to $H(\Lambda V, d)$ the implication (i) \implies (ii) is immediate, while (ii) \implies (iii) follows from Corollary 1 to Proposition 29.3. To prove (iii) \implies (i) let x_1, \dots, x_n be a basis of V such that $\deg x_1 \leq \deg x_2 \leq \dots$ and $dx_i \in \Lambda(x_1, \dots, x_{i-1})$. We show first by induction on i that if $\deg x_i$ is even then for some $N_i, x_i^{N_i} = d_\sigma \Psi_i$.

For this, divide by the ideal I_i generated by x_1, \dots, x_{i-1} to obtain a quotient Sullivan algebra $(\Lambda\bar{V}, \bar{d})$. Then x_i, \dots, x_n project to a basis (\bar{x}_j) of \bar{V} , and $\bar{d}\bar{x}_i = 0$. On the other hand, by the Mapping theorem 29.5 $(\Lambda\bar{V}, \bar{d})$ has finite category. Thus there is an element $\bar{\Phi} \in \Lambda(x_i, \dots, x_n)$ such that $\bar{d}\bar{\Phi} = \bar{x}_i^N$ (some N), where $\bar{\Phi}$ is the image of Φ in $\Lambda\bar{V}$. Since $\deg \bar{\Phi}$ is odd we have $\bar{\Phi} = \bar{\Phi}_1 + \bar{\Phi}_3 + \dots$ with $\bar{\Phi}_j \in \Lambda^j V^{\text{odd}} \otimes \Lambda V^{\text{even}}$. It follows that $(\bar{d})_\sigma \bar{\Phi}_1 = \bar{x}_i^N$, which implies that $d_\sigma \Phi_1 - x_i^N \in I_i$.

Define elements $y_j \in V$ by setting $y_j = x_j$ if $\deg x_j$ is even and $y_j = 0$ if $\deg x_j$ is odd. Since $\Phi_1 \in V^{\text{odd}} \otimes \Lambda V^{\text{even}}$ it follows that $d_\sigma \Phi_1 - x_i^N = \sum_{j < i} y_j \Omega_j$,

with $\Omega_j \in \Lambda V^{\text{even}}$. The induction hypothesis gives $y_j^{N_j} = d_\sigma \Psi_j$, $j < i$. Since $d_\sigma \Omega_j = 0$ follows that some power of x_i is a d_σ -coboundary. This closes the induction.

As in §32(a) put $Q = V^{\text{even}}$ and $P = V^{\text{odd}}$. We have just shown that for a basis y_j of Q some power $y_j^{N_j}$ is a d_σ -coboundary. It follows that $H_0(\Lambda Q \otimes \Lambda P, d_\sigma) = \Lambda Q / \Lambda Q \cdot d_\sigma(P)$ is finite dimensional. Hence $H(\Lambda Q \otimes \Lambda P, d_\sigma)$ is also finite dimensional (Proposition 32.1). □

Example 1 $\Lambda(a_2, x_3, u_3, b_4, v_5, w_7; da = dx = 0, du = a^2, db = ax, dv = ab - ux, dw = b^2 - vx)$.

Here subscripts denote degrees. The differential d_σ is given by $d_\sigma a = d_\sigma b = d_\sigma x = 0, d_\sigma u = a^2, d_\sigma v = ab, d_\sigma w = b^2$. Thus in $H(\Lambda V, d_\sigma)$ we have $[a]^2 = [b]^2 = 0$ and so $(\Lambda V, d)$ is elliptic. □

Example 2 *Adding variables of high degree.*

Suppose $(\Lambda V, d)$ is a minimal Sullivan algebra in which $V = V^{\geq 2}$ and V is finite dimensional. It is an interesting question of Anick whether, given an arbitrary positive integer n , there is an elliptic Sullivan algebra of the form $(\Lambda V \otimes \Lambda W, d)$ with W concentrated in degrees $\geq n$.

For example, consider the Sullivan algebra (subscripts denote degrees)

$$\Lambda(a_2, b_2, x_3, y_3, z_3, c_4; da = db = 0, dx = a^2, dy = ab, dz = b^2, dc = ya - xb).$$

It is not elliptic because $d_\sigma c = 0$ and no power of c is a d_σ -coboundary. On the other hand, if we add odd degree variables u, v and w with

$$\begin{aligned} du &= c^n a - n c^{n-1} xy, & dv &= c^{n+1} b - (n+1)uyb - (n+1)c^n xz + (n+1)uaz \\ \text{and } dw &= c^{2n+2} - 2(n+1)c^{n+1}uy - 2(n+1)vua + 2(n+1)vc^k x \end{aligned}$$

then we obtain an elliptic Sullivan algebra, since $d_\sigma w = c^{2n+2}$. □

Again let $(\Lambda V, d)$ be a minimal Sullivan algebra and denote by $\mathbb{k}[z]$ the polynomial algebra in a single variable, z , of degree 2. (Note $\mathbb{k}[z] = \Lambda z$, but we wish to emphasize that this is a polynomial algebra.)

Proposition 32.5 *Suppose V is finite dimensional and $V = V^{\geq 2}$, and suppose \mathbb{k} is algebraically closed. Then $(\Lambda V, d)$ is elliptic if and only if every morphism $\varphi : (\Lambda V, d) \rightarrow (\mathbb{k}[z], 0)$ is trivial.*

proof: Suppose $(\Lambda V, d)$ is elliptic and let x_1, \dots, x_n be a basis of V such that $dx_i \in \Lambda(x_1, \dots, x_{i-1})$. Given $\varphi : (\Lambda V, d) \rightarrow (\mathbb{k}[z], 0)$, suppose by induction that $\varphi x_i = 0, j < i$. Then φ factors to give a morphism $\bar{\varphi} : (\Lambda(\bar{x}_i, \dots, \bar{x}_n), \bar{d}) \rightarrow (\mathbb{k}[z], 0)$ from the quotient Sullivan model. If $\deg x_i$ is odd then $\varphi x_i = 0$. If $\deg x_i$ is even then, since this quotient model has finite category (Theorem 29.5), $\bar{x}_i^N = \bar{d}\Phi$, some N . Hence $(\varphi x_i)^N = \bar{\varphi}(\bar{x}_i^N) = d\bar{\varphi}\Phi = 0$. It follows that $\varphi x_i = 0$. Thus φ is trivial.

Conversely, suppose $(\Lambda V, d)$ is not elliptic. Then by Proposition 32.4, $H(\Lambda V, d_\sigma)$ is infinite dimensional, and hence so is $H_0(\Lambda V, d_\sigma)$, by Proposition 32.1. This algebra has the form $\Lambda(y_1, \dots, y_q)/I$ where I is generated by polynomials $f_i, 1 \leq i \leq p$. Since it is infinite dimensional there is some y_j such that $y_j^k \notin I$ for all k .

Extend the polynomial algebra $\Lambda(y_1, \dots, y_q)$ to a polynomial algebra $\Lambda(y_1, \dots, y_q, u)$ with $\deg u = -\deg y_j$. Then the ideal generated by f_1, \dots, f_p and by $y_j u - 1$ is properly contained in $\Lambda(y_1, \dots, y_q, u)$. Thus the Hilbert Nullstellensatz asserts the existence of scalars $t_1, \dots, t_q, t \in \mathbb{k}$ such that each $f_i(t_1, \dots, t_q) = 0$ and such that $t_j t = 1$. In particular, $t_j \neq 0$, and a non-trivial morphism $\psi : \Lambda(y_1, \dots, y_q)/I \rightarrow \mathbb{k}[z]$ is given by $y_i \mapsto t_i z^{a_i}$, where $\deg y_i = 2a_i$.

Finally, let $J \subset \Lambda V$ be the ideal generated by V^{odd} and by $\text{Im } d$. Then $\Lambda V/J = \Lambda V^{\text{even}}/\Lambda V^{\text{even}} \cdot d_\sigma(V^{\text{odd}}) = \Lambda(y_1, \dots, y_q)/I$, and a non-trivial morphism $(\Lambda V, d) \rightarrow \mathbb{k}[z]$ is obtained by composing $(\Lambda V, d) \rightarrow (\Lambda V/J, 0) \xrightarrow{\psi} \mathbb{k}[z]$. □

Example 3 Algebraic closure of \mathbb{k} is necessary in Proposition 32.3.

Indeed if $\mathbb{k} = \mathbb{Q}$ the Sullivan algebra $\Lambda(a_2, b_2, x_3; dx = a^2 + b^2)$ admits no non-trivial morphism to $\mathbb{Q}[z]$, since we would have $a \mapsto \alpha z, b \mapsto \beta z$ with $\alpha, \beta \in \mathbb{Q}$ satisfying $\alpha^2 + \beta^2 = 0$. □

Example 4 (Lechuga and Murillo,[106]) *n-colourable graphs.*

To each finite graph with vertices v_j and edges e_i and for each integer $n \geq 2$ associate a pure Sullivan algebra $(\Lambda Q \otimes \Lambda P, d)$ as follows: Q is concentrated in degree 2 and has a basis y_j corresponding to the vertices v_j ; P is concentrated in degree $2n - 3$ and has a basis x_i corresponding to the edges e_i ; finally $dx_i = \sum_s y_k^s y_\ell^{n-1-s}$, where y_k and y_ℓ correspond to the endpoints of e_i .

The graph is *n-colourable* if each vertex can be assigned one of n distinct colours so that vertices connected by an edge have different colours and, as shown in [121]:

$$A \text{ finite connected graph is } n\text{-colourable} \iff \dim H(\Lambda Q \otimes \Lambda P, d) = \infty.$$

Indeed we lose no generality in assuming \mathbb{k} is algebraically closed. If the graph is *n-colourable* identify the colours with the distinct n^{th} roots of unity w_α and note by $w_{\alpha(j)}$ the colour of the vertex v_j . If w_α and w_β are distinct n^{th} roots of unity then $\sum w_\alpha^s w_\beta^{n-s} = w_\alpha^n - w_\beta^n / w_\alpha - w_\beta = 0$, and so a non-trivial morphism $(\Lambda Q \otimes \Lambda P, d) \rightarrow \mathbb{k}[z]$ is given by $y_j \mapsto w_{\alpha(j)} z$ and $x_i \mapsto 0$.

Conversely, given a non-trivial morphism $\varphi : (\Lambda Q \otimes \Lambda P, d) \rightarrow \mathbb{k}[z]$ note that if y_k and y_ℓ correspond to the vertices of e_i then $0 = \varphi(dx_i)(\varphi y_k - \varphi y_\ell) = \sum_s (\varphi y_k)^s (\varphi y_\ell)^{n-s} (\varphi y_k - \varphi y_\ell) = (\varphi y_k)^n - (\varphi y_\ell)^n$. Since the graph is connected there is a single scalar λ such that $(\varphi y_j)^n = \lambda z^n$, and since some $\varphi y_j \neq 0$, $\lambda \neq 0$. Choose an n^{th} root of λ , $\bar{\lambda}$, and define $w_{\alpha(j)}$ by $\varphi y_j = w_{\alpha(j)} \bar{\lambda} z$. This n -colours the graph. \square

(c) Exponents and formal dimension.

Fix an elliptic Sullivan algebra $(\Lambda V, d)$ and bases y_1, \dots, y_q of V^{even} and x_1, \dots, x_p of V^{odd} . The sequences a_1, \dots, a_q and b_1, \dots, b_p defined by $\deg y_j = 2a_j$ and $\deg x_i = 2b_i - 1$ are independent (up to permutation) of the choice of basis.

Definition The integers a_1, \dots, a_q and b_1, \dots, b_p are respectively the *even* and the *odd exponents* of $(\Lambda V, d)$.

The *formal dimension* of $(\Lambda V, d)$ is the largest integer n (or ∞) such that $H^n(\Lambda V, d) \neq 0$.

In this topic we prove

Theorem 32.6 (Friedlander-Halperin [61]) *Suppose $(\Lambda V, d)$ is an elliptic Sullivan algebra with formal dimension n and even and odd exponents a_1, \dots, a_q and b_1, \dots, b_p . Then*

$$(i) \sum_{i=1}^p (2b_i - 1) - \sum_{j=1}^q (2a_j - 1) = n.$$

$$(ii) \sum_{j=1}^q 2a_j \leq n.$$

$$(iii) \sum_{i=1}^p (2b_i - 1) \leq 2n - 1.$$

$$(iv) \dim V^{\text{even}} \leq \dim V^{\text{odd}} \leq \text{cat}(\Lambda V, d).$$

Corollary 1 *If $(\Lambda V, d)$ is an elliptic Sullivan algebra of formal dimension n then V is concentrated in degrees $\leq 2n - 1$, and at most one basis element of V can have degree (necessarily odd) $> n$.*

Corollary 2 *If $(\Lambda V, d)$ is an elliptic Sullivan algebra of formal dimension n then $\dim V \leq n$.*

proof: We have $n = \sum_{i=1}^p (2b_i - 1) - \sum_{j=1}^q (2a_j - 1) \geq \sum_{i=1}^p (2b_i - 1) + q \geq p + q$, where $p = \dim V^{\text{odd}}$ and $q = \dim V^{\text{even}}$. \square

The proof of Theorem 32.6 depends on a reduction to the pure case (Lemma 32.7) and a characterization of exponents (Proposition 32.9).

Consider then an elliptic Sullivan algebra $(\Lambda V, d)$. By Proposition 32.4 the associated pure Sullivan algebra $(\Lambda V, d_\sigma)$ also has finite dimensional cohomology.

Lemma 32.7 $(\Lambda V, d_\sigma)$ and $(\Lambda V, d)$ have the same formal dimension.

proof: We argue by induction on $\dim V$. Write $(\Lambda V, d)$ as a relative Sullivan algebra $(\Lambda v \otimes \Lambda W, d)$ in which $V = \mathbb{k}v \oplus W$ and v is an element in V of minimal degree. The Mapping theorem 29.5 asserts that the quotient Sullivan algebra $(\Lambda W, \bar{d})$ has finite category; hence it too is elliptic (Proposition 32.4).

Next observe that if m is the formal dimension of $(\Lambda W, \bar{d})$ and n is the formal dimension of $(\Lambda V, d)$ then

$$n = \begin{cases} m + \deg v & \text{if } \deg v \text{ is odd} \\ m - \deg v + 1 & \text{if } \deg v \text{ is even.} \end{cases} \tag{32.8}$$

Indeed if $\deg v$ is odd (and therefore ≥ 3) this follows from the long exact cohomology sequence associated with

$$0 \rightarrow v \otimes (\Lambda W, \bar{d}) \rightarrow (\Lambda v \otimes \Lambda W, d) \rightarrow (\Lambda W, \bar{d}) \rightarrow 0 .$$

If $\deg v$ is even extend $(\Lambda V, d)$ to $(\Lambda V \otimes \Lambda \bar{v}, d)$ by setting $d\bar{v} = v$, and use the long exact cohomology sequence associated with

$$0 \rightarrow (\Lambda V, d) \rightarrow (\Lambda V \otimes \Lambda \bar{v}, d) \rightarrow (\Lambda V, d) \otimes \bar{v} \rightarrow 0$$

to conclude that formal dimension $(\Lambda V \otimes \Lambda \bar{v}, d) = n + \deg \bar{v} = n + \deg v - 1$. Then write $(\Lambda V \otimes \Lambda \bar{v}, d) = (\Lambda v \otimes \Lambda \bar{v} \otimes \Lambda W, d)$ and observe that because $H(\Lambda v \otimes \Lambda \bar{v}, d) = \mathbb{k}$ the surjection $(\Lambda V \otimes \Lambda \bar{v}, d) \rightarrow (\Lambda W, \bar{d})$ is a quasi-isomorphism.

This proves (32.8). The same argument applies to the relative Sullivan algebra $(\Lambda v \otimes \Lambda W, d_\sigma)$, and here the quotient Sullivan algebra $(\Lambda W, \bar{d}_\sigma)$ is just the pure Sullivan algebra associated with $(\Lambda W, \bar{d})$. By induction $(\Lambda W, \bar{d})$ and $(\Lambda W, \bar{d}_\sigma)$ have the same formal dimension. Thus formula (32.8) for $(\Lambda V, d)$ and for $(\Lambda V, d_\sigma)$ shows these have the same formal dimension too. \square

Our next step is to derive the fundamental property enjoyed by the exponents of an elliptic Sullivan algebra.

Proposition 32.9 (Friedlander-Halperin [61]) *Suppose a_1, \dots, a_q and b_1, \dots, b_p are the even and odd exponents of an elliptic Sullivan algebra $(\Lambda V, d)$. Then for any integer s ($1 \leq s \leq q$) and any subsequence a_{j_1}, \dots, a_{j_s} of even exponents, there are at least s odd exponents b_i that can be written in the form*

$$b_i = \sum_{\lambda=1}^s k_\lambda a_{j_\lambda} ,$$

where the k_λ are non negative integers (depending on b_i) and $\sum_\lambda k_\lambda \geq 2$.

proof: Since the associated pure Sullivan algebra is also elliptic (Proposition 32.4) we lose no generality in assuming that $(\Lambda V, d)$ is itself pure. Re-index the even exponents so that the subsequence in question is a_1, \dots, a_s . Let (y_j) and (x_i) be bases of V^{even} and V^{odd} chosen so $\deg y_j = 2a_j$ and $\deg x_i = 2b_i - 1$. Divide by the $y_j, j > s$, to obtain a pure elliptic Sullivan algebra of the form $(\Lambda(y_1, \dots, y_s) \otimes \Lambda(x_1, \dots, x_p), \bar{d})$.

Next, renumber the basis x_i so that $dx_i \neq 0, 1 \leq i \leq r$ and $dx_i = 0, i > r$. Then our pure Sullivan algebra has the form $(\Lambda(y_1, \dots, y_s) \otimes \Lambda(x_1, \dots, x_r), \bar{d}) \otimes (\Lambda(x_{r+1}, \dots, x_p), 0)$ and so $(\Lambda(y_1, \dots, y_s) \otimes \Lambda(x_1, \dots, x_r), \bar{d})$ is elliptic. By Proposition 32.2 (ii), $r \geq s$.

On the other hand, for $i \leq r, \bar{d}x_i$ is a non-zero polynomial in the y_j with no linear term, and so it contains a term of the form $y_1^{k_1} \dots y_s^{k_s}$ with $\sum k_\lambda \geq 2$. Thus $2b_i = \deg x_i + 1 = \sum_{\lambda=1}^s k_\lambda \deg y_\lambda = 2 \left(\sum_{\lambda=1}^s k_\lambda a_\lambda \right)$. □

Remark In [61] it is shown via a difficult argument from algebraic geometry that any pair of sequences a_1, \dots, a_q and b_1, \dots, b_p satisfying the conclusion of Proposition 32.9 are the even and odd exponents of an elliptic Sullivan algebra. Thus this condition precisely characterizes the possible degrees of a basis for V in an elliptic Sullivan algebra $(\Lambda V, d)$. □

proof of Theorem 32.6: In view of Lemma 32.7 we may suppose $(\Lambda V, d)$ is pure. Thus (i) is just Proposition 32.2 (iii). Now order the exponents so that $a_1 \geq a_2 \geq \dots \geq a_q$ and $b_1 \geq b_2 \geq \dots \geq b_q$. At least s of the b_i are non-trivial non-negative integral combinations of a_1, \dots, a_s (Proposition 32.9). In particular, at least s of the b_i satisfy $b_i \geq 2a_s$. This implies that $b_s \geq 2a_s$. Thus by (i)

$$n = \sum_{i=1}^p (2b_i - 1) - \sum_{j=1}^q (2a_j - 1) \geq \sum_{j=1}^q [(4a_j - 1) - (2a_j - 1)] = \sum_{j=1}^q 2a_j .$$

Similarly,

$$n = \sum_{i=1}^p (2b_i - 1) - \sum_{j=1}^q (2a_j - 1) \geq \sum_{i=1}^p (2b_i - 1) - \sum_{i=1}^p (b_i - 1) \geq \sum_{i=1}^p b_i ,$$

and so $2n - 1 \geq \sum_{i=1}^p (2b_i - 1)$.

This proves (i)–(iii). Proposition 32.2 (ii) asserts that $\dim V^{\text{even}} \leq \dim V^{\text{odd}}$, which is the first inequality of (iv). Finally, the homotopy Lie algebra L of $(\Lambda V, d)$ is finite dimensional, since sL is dual to V . Thus $\text{ad } x$ is locally nilpotent for all $x \in L$ and so Theorem 31.17 implies that $\text{cat}(\Lambda V, d) \geq \dim L_{\text{even}} (= \dim V^{\text{odd}})$. □

(d) Euler-Poincaré characteristic.

Recall (§3(e)) that the Euler-Poincaré characteristic χ_M of a finite dimensional graded vector space is defined by $\chi_M = \sum (-1)^i \dim M^i = \dim M^{\text{even}} - \dim M^{\text{odd}}$. If M is equipped with a differential, d , then $\chi_M = \chi_{H(M,d)}$, as follows from elementary linear algebra.

The purpose of this topic is to prove

Proposition 32.10 *Let χ be the Euler-Poincaré characteristic of the cohomology of an elliptic Sullivan algebra $(\Lambda V, d)$. Then*

$$\chi \geq 0 \quad \text{and} \quad \dim V^{\text{odd}} - \dim V^{\text{even}} \geq 0 .$$

Moreover, the following conditions are equivalent:

- (i) $\chi > 0$.
- (ii) $H(\Lambda V, d)$ is concentrated in even degrees.
- (iii) $H(\Lambda V, d)$ is the quotient $\Lambda(y_1, \dots, y_q)/(u_1, \dots, u_q)$ of a polynomial algebra in variables (y_j) of even degree by an ideal generated by a regular sequence (u_j) .
- (iv) $(\Lambda V, d)$ is isomorphic to a pure Sullivan algebra $(\Lambda Q \otimes \Lambda P, d)$ in which $Q = Q^{\text{even}}$, $P = P^{\text{odd}}$ and d maps a basis of P to a regular sequence in ΛQ .
- (v) $\dim V^{\text{odd}} - \dim V^{\text{even}} = 0$.

The proof of the Proposition relies in part on another invariant of pure Sullivan algebras, introduced originally by Koszul in [102]. If $(\Lambda Q \otimes \Lambda P, d)$ is a pure Sullivan algebra with $Q = Q^{\text{even}}$ and $P = P^{\text{odd}}$ then its *Koszul-Poincaré* series is the formal series $\mathcal{U}(z)$ given by

$$\mathcal{U}(z) = \sum_{r=0}^{\infty} \lambda_r z^r, \quad \lambda_r = \sum_k (-1)^k \dim(\Lambda Q \otimes \Lambda^k P)^{r-k} .$$

Lemma 32.11 *If $2a_1, \dots, 2a_q$ are the degrees of a basis (y_j) of Q and if $2b_1 - 1, \dots, 2b_p - 1$ are the degrees of a basis (x_i) of P then*

$$\mathcal{U}(z) = \frac{\prod_{i=1}^p (1 - z^{2b_i})}{\prod_{j=1}^q (1 - z^{2a_j})} .$$

proof: Write $\Lambda Q \otimes \Lambda P = \Lambda V$. Clearly $\mathcal{U} = \mathcal{U}_{\Lambda V}$ does not depend on the differential, and $\mathcal{U}_{\Lambda V \otimes \Lambda W} = \mathcal{U}_{\Lambda V} \cdot \mathcal{U}_{\Lambda W}$. Since $\Lambda V = \Lambda y_1 \otimes \cdots \otimes \Lambda y_q \otimes \Lambda x_1 \otimes \cdots \otimes \Lambda x_p$ and since (trivially)

$$\mathcal{U}_{\Lambda y_j}(z) = \frac{1}{1 - z^{2a_j}} \quad \text{and} \quad \mathcal{U}_{\Lambda x_i}(z) = 1 - z^{2b_i} ,$$

the lemma follows. □

Now while the Koszul-Poincaré series $\mathcal{U}(z) = \sum_r \lambda_r z^r$ for $(\Lambda Q \otimes \Lambda P, d)$ does not depend on the differential, it nonetheless gives important numerical information about $H(\Lambda Q \otimes \Lambda P, d)$. Indeed, since elements of $\Lambda Q \otimes \Lambda^k P$ have odd (even) degree if k is odd (even), λ_r is just the Euler-Poincaré characteristic of $C_r = \bigoplus_k (\Lambda Q \otimes \Lambda^k P)^{r-k}$. Moreover, because d decreases wordlength in P by 1 and increases degree by 1 it follows that d preserves each C_r . Thus λ_r is also the Euler-Poincaré characteristic of $H(C_r, d)$:

$$\lambda_r = \sum_k (-1)^k \dim H_k^{r-k}(\Lambda Q \otimes \Lambda P, d) ,$$

where $H_k(\Lambda Q \otimes \Lambda P)$ is as defined in §32(a).

Now suppose $H(\Lambda Q \otimes \Lambda P, d)$ is finite dimensional. Then $H(C_r) = 0$ (and hence $\lambda_r = 0$) for sufficiently large r ; i.e., $\mathcal{U}(z)$ is a polynomial. Moreover, since $\Lambda Q \otimes \Lambda P = \bigoplus_r C_r$, the Euler-Poincaré characteristic χ of $H(\Lambda Q \otimes \Lambda P, d)$ is given by

$$\chi = \sum_r \chi_{H(C_r)} = \sum_r \lambda_r = \mathcal{U}(1) . \tag{32.12}$$

proof of Proposition 32.10: Recall the odd spectral sequence (E_i, d_i) (§32(b)) for $(\Lambda V, d)$, whose E_1 -term is just the cohomology $H(\Lambda V, d_\sigma)$ of the associated pure Sullivan algebra. Since this is finite dimensional (Proposition 32.4) and since $E_{i+1} = H(E_i, d_i)$ the Euler-Poincaré characteristics satisfy

$$\chi_{H(\Lambda V, d_\sigma)} = \chi_{E_1} = \chi_{E_2} = \cdots .$$

Since $E_0^{*, -k} = \Lambda V^{\text{even}} \otimes \Lambda^k V^{\text{odd}}$ it vanishes unless $0 \leq k \leq \dim V^{\text{odd}}$ and so $E_\infty = E_i$, $i > \dim V^{\text{odd}}$. But E_∞ is the associated bigraded vector space for $H(\Lambda V, d)$ and we conclude that

$$\chi_{H(\Lambda V, d)} = \chi_{H(\Lambda V, d_\sigma)} . \tag{32.13}$$

On the other hand, if $2a_1, \dots, 2a_q$ are the degrees of a basis for V^{even} and if $2b_1 - 1, \dots, 2b_p - 1$ are the degrees for a basis of V^{odd} then Lemma 32.11 asserts that the Koszul-Poincaré series \mathcal{U} for $(\Lambda V, d_\sigma)$ satisfies

$$\mathcal{U}(z) \prod_{j=1}^q (1 - z^{2a_j}) = \prod_{i=1}^p (1 - z^{2b_i}) .$$

Since $\mathcal{U}(z)$ is a polynomial and since $z = 1$ occurs as a root with multiplicity 1 in $1 - z^m$ it follows that $p \geq q$ and that $z = 1$ occurs as a root of $\mathcal{U}(z)$ with multiplicity $p - q$. Since $p = \dim V^{\text{odd}}$ and $q = \dim V^{\text{even}}$ we have shown that $\dim V^{\text{odd}} \geq \dim V^{\text{even}}$ (another proof is given in Theorem 32.6), that $\chi_{H(\Lambda V, d)} = \chi_{H(\Lambda V, d_\sigma)} = \mathcal{U}(1) = 0$ if $\dim V^{\text{odd}} > \dim V^{\text{even}}$ and that if $\dim V^{\text{odd}} = \dim V^{\text{even}} = q$ then

$$\chi_{H(\Lambda V, d)} = \mathcal{U}(1) = \prod_{i=1}^q b_i / \prod_{i=1}^q a_i > 0. \tag{32.14}$$

This proves the first assertion of the Proposition and the equivalence (i) \iff (v).

Now clearly (iii) \implies (ii) \implies (i), and Proposition 32.3 asserts that (iv) \implies (iii). It remains to show that (i) \implies (iv). If (i) holds then, since (i) \implies (v), $\dim V^{\text{even}} = \dim V^{\text{odd}}$. Since $H(\Lambda V, d_\sigma)$ is finite dimensional (Proposition 32.4), Proposition 32.2(ii) asserts that $H_+(\Lambda V, d_\sigma) = 0$. It follows (Proposition 32.3) that if (x_i) is a basis of V^{odd} then $(d_\sigma x_i)$ is a regular sequence in ΛV^{even} and that $H(\Lambda V, d_\sigma) = H_0(\Lambda V, d_\sigma) = \Lambda V^{\text{even}} / (d_\sigma x_1, \dots, d_\sigma x_q)$.

In particular, $H(\Lambda V, d_\sigma)$ is evenly graded and so the differentials d_1, d_2, \dots in the odd spectral sequence all vanish. In other words $H(\Lambda V, d_\sigma)$ is the bigraded vector space associated with $H(\Lambda V, d)$. Let y_1, \dots, y_q be a basis for V^{even} . Since $d_\sigma y_i = 0$ there are elements $\Phi_i \in \Lambda V^{\text{even}} \otimes \Lambda^+ V^{\text{odd}}$ such that $d(y_i + \Phi_i) = 0$. Put $y'_i = y_i + \Phi_i$ and note that $(\Lambda V, d) = \Lambda(y'_1, \dots, y'_q) \otimes \Lambda V^{\text{odd}}$. Thus without loss of generality we may assume $d = 0$ in V^{even} .

Finally let x_1, \dots, x_q be a basis of V^{odd} such that $\deg x_1 \leq \dots \leq \deg x_q$ and suppose by induction that for $i < k$ we have found elements $\Psi_i \in \Lambda V^{\text{even}} \otimes \Lambda^{\geq 3} V^{\text{odd}}$ such that $d(x_i + \Psi_i) = d_\sigma x_i$. Replace x_i by $x_i + \Psi_i$ to reduce to the case $dx_i = d_\sigma x_i$, $i < k$. Then $d = d_\sigma$ in $\Lambda V^{\text{even}} \otimes \Lambda(x_1, \dots, x_{k-1})$. Since $d_\sigma x_1, \dots, d_\sigma x_{k-1}$ is a regular sequence, Proposition 32.3 implies that $d_\sigma x_k - dx_k$ is a d_σ -coboundary in $\Lambda V^{\text{even}} \otimes \Lambda^+ V^{\text{odd}}$ and hence it has the form $d_\sigma \Psi_k$, some $\Psi_k \in \Lambda V^{\text{even}} \otimes \Lambda^{\geq 3} V^{\text{odd}}$. By construction $d\Psi_k = d_\sigma \Psi_k$, and so $d_\sigma x_k = d(x_k + \Psi_k)$.

Now set $x'_i = x_i + \Psi_i$. Then $(\Lambda V, d) = \Lambda(y'_1, \dots, y'_q, x'_1, \dots, x'_q)$, with $dy'_j = 0$ and dx'_1, \dots, dx'_q a regular sequence in $\Lambda(y'_1, \dots, y'_q)$. \square

Corollary *If $\dim V^{\text{even}} = \dim V^{\text{odd}} = q$ then*

$$\sum_r \dim H^r(\Lambda V, d) z^r = \frac{\prod_{i=1}^q (1 - z^{2b_i})}{\prod_{j=1}^q (1 - z^{2a_j})}$$

and $\chi_{H(\Lambda V, d)} = \dim H(\Lambda V, d) = \prod_{i=1}^q b_i / \prod_{j=1}^q a_j$.

proof: Since $H(\Lambda V, d) \cong H(\Lambda V, d_\sigma) = H_0(\Lambda V, d_\sigma)$ we have in the Koszul-Poincaré series \mathcal{U} for $(\Lambda V, d_\sigma)$ that

$$\lambda_r = \sum_k (-1)^k \dim H_k^{r-k}(\Lambda V, d_\sigma) = \dim H^r(\Lambda V, d) .$$

Apply Lemma 32.11. □

(e) Rationally elliptic topological spaces.

Let X be a simply connected topological space with finite dimensional rational homology. The *formal dimension* n_X of X is the maximum integer such that $H^{n_X}(X; \mathbb{Q}) \neq 0$, and its *Euler-Poincaré characteristic* is the integer $\chi_X = \sum_p (-1)^p \dim H^p(X; \mathbb{Q})$. Recall that X is *rationally elliptic* if the graded vector space $\pi_*(X) \otimes \mathbb{Q}$ is also finite dimensional. In this case we set

$$\chi_\pi(X) = \dim \pi_{\text{even}}(X) \otimes \mathbb{Q} - \dim \pi_{\text{odd}}(X) \otimes \mathbb{Q} ,$$

and we let $2a_1, \dots, 2a_q$ and $2b_1 - 1, \dots, 2b_p - 1$ be the degrees of a basis of $\pi_*(X) \otimes \mathbb{Q}$, so that $p = \dim \pi_{\text{odd}}(X) \otimes \mathbb{Q}$ and $q = \dim \pi_{\text{even}}(X) \otimes \mathbb{Q}$.

Since the minimal Sullivan model, $(\Lambda V, d)$, for X satisfies

$$H(\Lambda V, d) \cong H^*(X; \mathbb{Q}) , \quad V \cong \pi_*(X) \otimes \mathbb{Q} \quad \text{and} \quad \text{cat}(\Lambda V, d) = \text{cat}_0 X$$

we may translate Theorem 32.6 and Proposition 32.10 and their corollaries as follows:

Theorem 32.15 *If X is a rationally elliptic space then, in the notation above,*

$$(i) \quad n_X = \sum_{i=1}^p (2b_i - 1) - \sum_{j=1}^q (2a_j - 1).$$

$$(ii) \quad n_X \geq \sum_{j=1}^q 2a_j.$$

$$(iii) \quad 2n_X - 1 \geq \sum_{i=1}^p (2b_i - 1).$$

$$(iv) \quad \dim \pi_{\text{even}}(X) \otimes \mathbb{Q} \leq \dim \pi_{\text{odd}}(X) \otimes \mathbb{Q} \leq \text{cat}_0 X .$$

In particular $\pi_(X) \otimes \mathbb{Q}$ is concentrated in degrees $\leq 2n_X - 1$ and $\dim \pi_*(X) \otimes \mathbb{Q} \leq n_X$. □*

Proposition 32.16 *If X is a rationally elliptic space then in the notation above*

$$\chi_X \geq 0 \quad \text{and} \quad \chi_\pi(X) \leq 0 .$$

Moreover, the following conditions are equivalent:

- (i) $\chi_X > 0$.
- (ii) $H^*(X; \mathbb{Q})$ is the quotient of a polynomial algebra in q variables of even degree by an ideal generated by a regular sequence of length q .
- (iii) $\dim \pi_{\text{even}}(X) \otimes \mathbb{Q} = \dim \pi_{\text{odd}}(X) \otimes \mathbb{Q}$.

If these conditions hold then

$$\sum_k \dim H^k(X; \mathbb{Q}) z^k = \frac{\prod_{i=1}^q (1 - z^{2b_i})}{\prod_{j=1}^q (1 - z^{2a_j})} \quad \text{and} \quad \chi_X = \frac{\prod_{i=1}^q b_i}{\prod_{j=1}^q a_j} .$$

□

Example 1 *Simply connected finite H -spaces are rationally elliptic.*

If G is as in the title then its Sullivan model is an exterior algebra on a graded vector space P_G of finite dimension concentrated in odd degrees, and has zero differential (Example 3, §12(a)). The dimension of P_G is called the *rank* of G . □

Example 2 *Simply connected compact homogeneous spaces G/K are rationally elliptic.*

Proposition 15.16 asserts that these spaces have a Sullivan model of the form $(\Lambda V_{B_K} \otimes \Lambda P_G, d)$, where $d = 0$ in ΛV_{B_K} , V_{B_K} is concentrated in even degrees, $d(P_G) \subset \Lambda V_{B_K}$ and P_G and V_{B_K} are finite dimensional. Note that this is a pure Sullivan algebra.

In this example we have $\chi_\pi(G/K) = \dim V_{B_K} - \dim P_G = \dim P_K - \dim P_G$, (even though the Sullivan algebra may not be minimal). Thus

$$\chi_\pi(G/K) = \text{rank}(K) - \text{rank}(G) .$$

Example 3 (Allday-Halperin [3]) *Free torus actions.*

Suppose an r -torus $T = S^1 \times \cdots \times S^1$ (r factors) acts smoothly and freely on a simply connected compact smooth manifold M . Then the projection $M \rightarrow M/T$ onto the orbit space is a smooth principal bundle. Hence there is a classifying map $M/T \rightarrow BT$ whose homotopy fibre is homotopy equivalent to M (§2(e)).

Now assume M is rationally elliptic. Since $BT = \mathbb{C}P^\infty \times \cdots \times \mathbb{C}P^\infty$ its homotopy groups are concentrated in degree 2, and since M/T is compact its homology is finite dimensional. Thus M/T is rationally elliptic. It is immediate from the long exact homotopy sequence that

$$\chi_\pi(M/T) = \chi_\pi(M) + \chi_\pi(BT) = \chi_\pi(M) + r .$$

On the other hand, Theorem 32.15 asserts that $\chi_\pi(M/T) \leq 0$ and so we conclude that

$$r \leq -\chi_M ;$$

i.e., $-\chi_M$ is an upper bound for the dimension of a free torus acting on M .

In the case of homogeneous spaces G/K (Example 2, above) this shows that $\text{rank } G - \text{rank } K$ is an upper bound for the dimension of a torus acting freely on G/K . □

(f) Decomposability of the loop spaces of rationally elliptic spaces.

Let X be a simply connected CW complex. Recall the localization $X_{\mathcal{P}}$ (§9(b)) at a set of primes \mathcal{P} , obtained by ‘inverting the primes not in \mathcal{P} .’ Here we prove

Theorem 32.17 (McGibbon-Wilkerson [117]) *If the integral homology $H_*(X; \mathbb{Z})$ is a finitely generated abelian group and if X is rationally elliptic then inverting some finite set of primes gives a localization $X_{\mathcal{P}}$ such that there is a weak homotopy equivalence*

$$\Omega X_{\mathcal{P}} \simeq \prod_i \Omega S_{\mathcal{P}}^{2b_i-1} \times \prod_j S_{\mathcal{P}}^{2a_j-1} .$$

Corollary *If X is a rationally elliptic finite CW complex then $H_*(\Omega X; \mathbb{Z})$ has p -torsion for only finitely many primes p .*

Remark By contrast Anick [9] and Avramov [15] construct simply connected finite CW complexes X such that $H_*(\Omega X; \mathbb{Z})$ has torsion of all orders.

proof of Theorem 32.7: In the course of the proof we shall use a little ‘integral’ homotopy theory not derived in this monograph.

The proof is by induction on $\dim \pi_*(X) \otimes \mathbb{Q}$ and for purposes of the induction we prove the theorem under the slightly more general hypothesis that for some finite set of primes p_1, \dots, p_n , $H_*(X; R)$ is a finitely generated module over $R = \mathbb{Z} \left(\frac{1}{p_1}, \dots, \frac{1}{p_n} \right) \subset \mathbb{Q}$. In this case we may replace X by a $CW_{\mathcal{P}}$ -complex

(\mathcal{P} = primes of R) with cells in finitely many dimensions. In the proof we shall often extend R (and further localize X) by inverting finitely many additional primes, and then continue to denote the result by R (and by X). We shall also denote by S^k the localization $S^k_{\mathcal{P}}$.

We shall frequently rely on the following observation. Suppose given continuous maps $X \xrightarrow{f} Y \xleftarrow{g} Z$ in which g is a rational homotopy equivalence and each $H_k(Y; \mathbb{Z})$ and $H_k(Z; \mathbb{Z})$ are finitely generated R -modules. Then after inverting finitely many more primes we can find localizations $X_{\mathcal{P}'} \xrightarrow{f_{\mathcal{P}'}} Y_{\mathcal{P}'} \xleftarrow{g_{\mathcal{P}'}} Z_{\mathcal{P}'}$ and a map $h : X_{\mathcal{P}'} \rightarrow Z_{\mathcal{P}'}$ such that $g_{\mathcal{P}'} h \sim f_{\mathcal{P}'}$. Indeed, we may assume Y and Z are $CW_{\mathcal{P}}$ -complexes of finite type and that f maps X into a finite sub $CW_{\mathcal{P}}$ -complex of Y . Invert finitely many primes to make g a homology isomorphism between large skeleta and then compose h with the homotopy inverse.

Note as well that by inverting finitely many primes we may arrange that X is $(r-1)$ -connected and that $H_r(X; \mathbb{Z})$ is a non-zero free R -module. We distinguish two cases:

Case 1: r is odd.

Since $H_r(X; \mathbb{Z})$ is a non-zero free R -module there are continuous maps $S^r \xrightarrow{f} X \xrightarrow{g} K(R, r)$ such that $\pi_r(gf)$ is an isomorphism (Theorem 4.19 and Proposition 4.20). Since r is odd the composite is a rational homotopy equivalence (Example 3, §15(b)). Thus by inverting finitely more primes we can construct $h : X \rightarrow S^r$ such that $hf \sim id$.

Let $i : F \rightarrow X$ be the ‘inclusion’ of the homotopy fibre of h . Then (cf. §2(c)) there is a principal ΩS^r -fibration $\Omega S^r \rightarrow F \rightarrow X$. Since ([2]) $H_*(\Omega S^r; R)$ is the polynomial algebra $R[\alpha_{r-1}]$ and $H_*(X; R)$ is finitely generated, a Serre spectral sequence argument shows that $H_*(F; R)$ is noetherian over $R[\alpha_{r-1}]$ and hence has torsion at only finitely many primes. By inverting these we can arrange that $H_*(F; R)$ is torsion free. On the other hand the Mapping theorem 28.6 asserts that $\text{cat}_0 F < \infty$, and hence (Proposition 32.4) F is rationally elliptic. Thus $H_*(F; \mathbb{Q})$ is finite dimensional and $H_*(F; R)$ is a finitely generated R -module.

But $\dim \pi_*(F) \otimes \mathbb{Q} < \dim \pi_*(X) \otimes \mathbb{Q}$ and so the theorem holds for F by induction. Since $\Omega i \cdot \Omega f : \Omega F \times \Omega S^r \rightarrow \Omega X$ is a weak homotopy equivalence, the theorem holds for X as well.

Case 2: r is even, $r = 2q$.

As in the previous case we have $S^r \xrightarrow{f} X \xrightarrow{g} K(R, r)$ with $\pi_r(gf)$ an isomorphism. Recall the definition of the special unitary group $SU(q)$. As in Example 3, §15(f) there is an action of $SU(q)$ on S^{2q-1} and this gives an associated fibre bundle $p : ESU(q) \times_{SU(q)} S^{2q-1} \rightarrow BSU(q)$ with fibre S^{2q-1} (§2(e)).

The calculations referred to in Example 3, §15(f) show that $BSU(q)_{\mathbb{Q}} \simeq \prod_{i=2}^q K(2i-1, \mathbb{Q})$ and that the connecting homomorphism ∂_* for p maps a basis element for $\pi_{2q} BSU(q)_{\mathbb{Q}}$ to $S^{2q-1}_{\mathbb{Q}}$. Thus by inverting finitely many primes we obtain from $g : X \rightarrow K(R, r)$ a map $h : X \rightarrow BSU(q)_{\mathcal{P}}$ such that

$$\partial_*[hf] = [S^{2q-1}].$$

Use h to pull the spherical fibration back to a fibration $S^{2q-1} \xrightarrow{\varepsilon} E \xrightarrow{\pi} X$ whose connecting homomorphism maps $[f]$ to $[S^{2q-1}]$. This implies that $\dim \pi_*(E) \otimes \mathbb{Q} < \dim \pi_*(X) \otimes \mathbb{Q}$ while a Serre spectral sequence argument shows that $H_*(E; R)$ is a finitely generated R -module. Thus by induction, the theorem holds for E .

Finally, as in §2(c) we have a fibration $\Omega E \rightarrow \Omega X \rightarrow S^{2q-1}$ which, after finitely many primes are inverted, admits a cross-section. Thus multiplication in ΩX defines a weak homotopy equivalence $\Omega E \times S^{2q-1} \xrightarrow{\cong} \Omega X$. \square

Exercises

1. Determine all the elliptic spaces X satisfying $\dim L_X \leq 3$.
2. Let X be an elliptic space and denote by n the maximal length of a nonzero Whitehead bracket. Prove that $\text{cat}_0 X \geq n/2$.

33 Growth of Rational Homotopy Groups

In this section the ground ring k is an arbitrary field of characteristic zero.

Suppose that X is a simply connected topological space with rational homology of finite type. In this section we describe the implications for $\pi_*(X) \otimes \mathbb{Q}$ of the hypothesis that X has finite rational category. If $\dim \pi_*(X) \otimes \mathbb{Q}$ is finite then X is rationally elliptic (Proposition 32.4) and its properties are described in §32. Thus the focus here is on spaces X such that $\dim \pi_*(X) \otimes \mathbb{Q} = \infty$.

Definition A simply connected topological space X with rational homology of finite type is called *rationally hyperbolic* if $\text{cat}_0 X < \infty$ and $\dim \pi_*(X) \otimes \mathbb{Q} = \infty$.

The justification for the terminology lies in our first main result:

- *If X is rationally hyperbolic then $\sum_{i=2}^k \dim \pi_i(X) \otimes \mathbb{Q}$ grows exponentially in k .*

Note that this defines a dichotomy:

- *Simply connected spaces X with rational homology of finite type and finite rational category are either:*
 - *rationally elliptic, with $\pi_*(X) \otimes \mathbb{Q}$ finite dimensional, or else*
 - *rationally hyperbolic, with $\pi_*(X) \otimes \mathbb{Q}$ growing exponentially.*

The result above leaves open the possibility of large intervals $[r, s]$ such that $\pi_i(X) \otimes \mathbb{Q} = 0$, $r \leq i \leq s$. However, this cannot happen: it follows from Theorem 31.16 that

- *If X is rationally hyperbolic then there are integers N and d such that*

$$\pi_{N+kd}(X) \otimes \mathbb{Q} \neq 0, \quad k \geq 0.$$

This assertion can be considerably improved in the case that $H_*(X; \mathbb{Q})$ has finite dimension. In this case we let n_X be the *formal dimension* of X ; n_X is the largest integer such that $H_{n_X}(X; \mathbb{Q}) \neq 0$. Then we show that

- *If X has finite dimensional rational homology and formal dimension n_X then either*
 - *X is rationally elliptic and $\pi_i(X) \otimes \mathbb{Q} = 0$, $i \geq 2n_X$, or else*
 - *X is rationally hyperbolic and for each $k \geq 1$, $\pi_i(X) \otimes \mathbb{Q} \neq 0$, some $i \in (k, k + n_X)$.*

In particular, if X is rationally hyperbolic the non-zero rational homotopy groups of X occur at intervals of at most $n_X - 1$.

This section is organized as follows:

- (a) Exponential growth of rational homotopy groups.

- (b) Spaces whose rational homology is finite dimensional.
- (c) Loop space homology.

(a) Exponential growth of rational homotopy groups.

Proposition 33.1 *Let X be a simply connected topological space with rational homology of finite type. If X is rationally hyperbolic then*

- (i) $\dim \pi_{\text{odd}}(X) \otimes \mathbb{Q} = \infty$.
- (ii) For some integers N and d : $\pi_{N+kd}(X) \otimes \mathbb{Q} \neq 0, k \geq 0$.

proof: Let $(\Lambda V, d)$ be a minimal Sullivan model for X . Then $\text{cat}(\Lambda V, d) = \text{cat}_0 X < \infty$. For any $n \geq 2$, divide by $V^{<n}$ to obtain a quotient Sullivan algebra $(\Lambda V^{\geq n}, \bar{d})$, which also has finite category (Mapping theorem 29.5). Since $\dim \pi_p(X) \otimes \mathbb{Q} = \dim V^p, p \geq 1$, it follows that $V^{\geq n} \neq 0$. If $V^{\geq n}$ were concentrated in even degrees we would have $\bar{d} = 0$ and $H(\Lambda V^{\geq n}, \bar{d}) = \Lambda V^{\geq n}$ would be a polynomial algebra, contradicting $\text{cat}(\Lambda V^{\geq n}, \bar{d}) < \infty$. It follows that V^{odd} is infinite dimensional, which proves (i).

Let L be the homotopy Lie algebra of $(\Lambda V, d)$. Since L_k is dual to V^{k+1} , L_{even} is infinite dimensional. Thus according to Theorem 31.17 for some non-zero $\alpha \in L_{\text{even}}$ and some $\beta \in L$ the iterated Lie brackets $(\text{ad } \alpha)^k \beta$ are all non-zero. This proves (ii). □

Theorem 33.2 *Let X be a simply connected topological space with rational homology of finite type. If X is rational hyperbolic then for some $C > 1$ and some positive integer K :*

$$\sum_{i=0}^k \dim \pi_i(X) \otimes \mathbb{Q} \geq C^k, \quad k \geq K.$$

proof: Let $(\Lambda V, d)$ be a minimal Sullivan model for X . As in the proof of Proposition 33.1 we have to show that because $\text{cat}(\Lambda V, d) < \infty$ and $\dim V = \infty$, $\sum_{i=0}^k \dim V^i \geq C^k, k \geq K$ for suitable C and K . Set $m = \text{cat}(\Lambda V, d)$.

Now for any integer k dividing by $V^{<k}$ gives a quotient minimal Sullivan algebra which we can write as $(\Lambda V^{[k, 2k-2]} \otimes \Lambda V^{\geq 2k-1}, \bar{d})$, where $V^{[k, \ell]} = \{V^i\}_{k \leq i \leq \ell}$. By minimality $\bar{d} = 0$ in $V^{[k, 2k-2]}$. Moreover, this quotient Sullivan algebra has category $\leq m$ (Mapping theorem 29.5) and hence the product of $m + 1$ cohomology classes is always zero (Corollary to Proposition 29.3). Thus in particular,

$$\Lambda^{m+1} V^{[k, 2k-2]} \subset \text{Im } \bar{d}.$$

Define $\alpha : V^{\geq 2k-1} \rightarrow \Lambda V^{[k, 2k-2]}$ by requiring that $\bar{d} = \alpha + \beta$ with $\text{Im } \beta$ in the ideal generated by $V^{\geq 2k-1}$. If α_r is the component of α in $\Lambda^r V^{[k, 2k-2]}$ then we have

$$\Lambda^{m+1} V^{[k, 2k-2]} = \bigoplus_{p=2}^{m+1} \alpha_p (V^{\geq 2k-1}) \cdot \Lambda^{m+1-p} V^{[k, 2k-2]} .$$

Since $\Lambda^p V^{[k, 2k-2]}$ is concentrated in degrees $i \in [pk, 2pk - 2p]$ it follows that

$$\dim \Lambda^{m+1} V^{[k, 2k-2]} \leq \sum_{p=2}^{m+1} \dim V^{[pk-1, 2pk-4]} \dim \Lambda^{m+1-p} V^{[k, 2k-2]} .$$

Now for each integer k set $\lambda(k) = \sum_{i=k}^{2k-2} \dim V^i$. Denote $2^{m+1}(m+1)!m$ by c_m and use Proposition 33.1 (ii) to find an integer N such that

$$\lambda(k) \geq c_m^3, \quad k \geq N .$$

Then it follows from the inequality above that if $k \geq N$,

$$\frac{\lambda(k)^{m+1}}{2^{m+1}(m+1)!} \leq \sum_{p=2}^{m+1} \lambda(pk-1) \lambda(k)^{m+1-p} .$$

This in turn implies that for some $p \in [2, m+1]$,

$$\lambda(pk-1) \geq \frac{\lambda(k)^p}{c_m} .$$

In particular, $\lambda(pk-1) \geq \lambda(k)$ and $\lambda(pk-1)^{1/pk-1} \geq \left[\frac{\lambda(k)}{c_m} \right]^{1/k}$.

Iterating this process yields a sequence of integers $N_0 < N_1 < \dots$ such that $N_0 = N$ and $N_{i+1} = p_i N_i - 1$ (some $p_i \in [2, m+1]$), and such that

$$\lambda(N_i)^{1/N_i} \geq \left[\frac{\lambda(N_{i-1})}{c_m} \right]^{1/N_{i-1}}, \quad i \geq 1 .$$

But since $N_{i+1} \geq \frac{3}{2} N_i$ we have $\sum_0^\infty \frac{1}{N_i} \leq \frac{1}{N} \sum_{i=0}^\infty \left(\frac{2}{3}\right)^i = \frac{3}{N}$. Thus $c_m^{\sum \frac{1}{N_j}} \leq c_m^{3/N}$, and it follows that

$$\lambda(N_i)^{\frac{1}{N_i}} \geq \left(\frac{\lambda(N)}{c_m^3} \right)^{1/N} .$$

Now for any $i \geq 1$ and for $N_i \leq r < N_{i+1}$ we have $r \leq (m+1)^2 N_{i-1}$ and

$$\sum_{n=0}^r \dim V^n \geq \lambda(N_{i-1}) \geq \left(\frac{\lambda(N)}{c_m^3} \right)^{\frac{r}{(m+1)^2 N}} .$$

In other words, setting $C = \left[\frac{\lambda(N)}{c_m^3} \right]^{\frac{1}{(m+1)^{2N}}}$ we have $\sum_{n=0}^r \dim V^n \geq C^r, r \geq N. \square$

(b) Spaces whose rational homology is finite dimensional.

Theorem 33.3 *Suppose X is a simply connected topological space with finite dimensional rational homology and formal dimension n_X . Then either $\pi_i(X) \otimes \mathbb{Q} = 0, i \geq 2n_X$ or else for each $k \geq 1, \pi_i(X) \otimes \mathbb{Q} \neq 0$ for some $i \in (k, k + n_X)$.*

proof: If $\dim \pi_*(X) \otimes \mathbb{Q}$ is finite then Theorem 32.15 asserts that $\pi_i(X) \otimes \mathbb{Q} = 0, i \geq 2n_X$. Thus if X were a counterexample to the theorem there would be integers $k \geq 1$ and $\ell \geq n_X + k$ such that $\pi_i(X) \otimes \mathbb{Q} = 0, k < i < \ell$, and $\pi_\ell(X) \otimes \mathbb{Q}$ is non-zero. It follows (Theorem 15.11) that a minimal Sullivan model for X (over any field \mathbb{k} of characteristic zero) has the form $(\Lambda U \otimes \Lambda W, d)$ in which $U = U^{\leq k}$ and $W = W^{\geq \ell}$ are non-zero graded vector spaces and $W^\ell \neq 0$. Moreover, $H^i(\Lambda U \otimes \Lambda W, d) \cong H^i(X; \mathbb{k}) = 0, i > n_X$. We shall show that this is impossible.

Denote by $(\Lambda W, \bar{d})$ the quotient Sullivan algebra and let b be a variable of arbitrary degree. The main step in the proof is

Lemma 33.4 *In the situation of the proof of Theorem 33.3 suppose given a morphism of the form $\rho : (\Lambda U, d) \rightarrow (\Lambda b, 0)$. Then the identity in Λb extends to an isomorphism of cochain algebras*

$$\Lambda b \otimes_{\Lambda U} (\Lambda U \otimes \Lambda W, d) \cong (\Lambda b, 0) \otimes (\Lambda W, \bar{d}) .$$

proof: Given any Sullivan algebra $(\Lambda V, d)$, define \hat{V} by $\hat{V}^k = V^{k-1}$ and denote corresponding elements by $v \longleftrightarrow \hat{v}$. Define a commutative cochain algebra $(\Lambda V \otimes (\mathbb{k} \oplus \hat{V}), \delta)$ as follows:

- Multiplication by elements in ΛV is just multiplication on the left in $\Lambda V \otimes (\mathbb{k} \oplus \hat{V})$, and $\hat{V} \cdot \hat{V} = 0$.
- $\delta = d + s$, where s is the derivation defined by $sv = \hat{v}$ and $s\hat{v} = 0$, and where $d(\Phi \otimes 1) = d\Phi \otimes 1$ and $d\hat{v} = -sdv$.

This construction is natural: if $\varphi : (\Lambda V, d) \rightarrow (\Lambda Z, d)$ is a morphism of Sullivan algebras, extend it to $\hat{\varphi} : (\Lambda V \otimes (\mathbb{k} \oplus \hat{V}), \delta) \rightarrow (\Lambda Z \otimes (\mathbb{k} \oplus \hat{Z}), \delta)$ by setting $\hat{\varphi}\hat{v} = s\varphi v$. Moreover, division by \hat{V} defines a natural surjective cochain algebra morphism $\pi : (\Lambda V \otimes (\mathbb{k} \oplus \hat{V}), \delta) \rightarrow (\Lambda V, d)$.

In particular, denote the cochain algebra $(\Lambda U \otimes (\mathbb{k} \oplus \hat{U}), \delta)$ simply by (A, δ) . The key observation is then that there is a relative Sullivan algebra

$$(A, \delta) \longmapsto (A \otimes \Lambda W, \delta)$$

such that applying $\Lambda U \otimes_A -$ yields the original relative Sullivan algebra $\Lambda U \rightarrow \Lambda U \otimes \Lambda W$. The derivations d in A and in $\Lambda U \otimes \Lambda W$ extend uniquely to a derivation d in $A \otimes \Lambda W = A \otimes_{\Lambda U} (\Lambda U \otimes \Lambda W)$. Now extend the derivation s in A to a derivation s in $A \otimes \Lambda W$ by constructing its restriction to W as a linear map $W \rightarrow \Lambda U \otimes \hat{U} \otimes \Lambda W$ such that $dsw = -sdw$, $w \in W$. Then $sd + ds = 0$, and $s^2 = 0$ because s will automatically vanish in $\Lambda U \otimes \hat{U} \otimes \Lambda W$. Thus $\delta = d + s$ is a differential.

Suppose by induction that s is defined in $W^{<r}$. If $w \in W^r$, then by construction $dsw = -sd^2w = 0$, and so sdw is a d -cocycle in $\Lambda U \otimes \hat{U} \otimes \Lambda W$. Since $r \geq \ell \geq k + n_X$ it follows that $\text{deg } sdw \geq k + n_X + 2$. On the other hand, \hat{U} is concentrated in degrees $\leq k + 1$ and $H(\Lambda U \otimes \Lambda W, d)$ is concentrated in degrees $\leq n_X$. Hence $H^i(\Lambda U \otimes \hat{U} \otimes \Lambda W, d) = 0$, $i \geq k + n_X + 2$, and sdw must be a d -coboundary. Thus we may extend s to W^r so $dsw = -sdw$, $w \in W^r$. This constructs δ .

Next, given $\varrho : (\Lambda U, d) \rightarrow (\Lambda b, 0)$ extend it to $\hat{\varrho} : (A, \delta) \rightarrow (\Lambda b \otimes (\mathbb{k} \oplus \mathbb{k}\hat{b}), \delta)$ as described above. Define the quotient cochain algebra (B, δ) by

$$B = \begin{cases} \Lambda b \otimes (\mathbb{k} \oplus \mathbb{k}\hat{b}), & \text{deg } b \text{ is even.} \\ \Lambda b \otimes (\mathbb{k} \oplus \mathbb{k}\hat{b})/b\hat{b}, & \text{deg } b \text{ is odd.} \end{cases}$$

Set $(B \otimes \Lambda W, \delta) = B \otimes_A (A \otimes \Lambda W, \delta)$. By inspection $H(B, \delta) = \mathbb{k}$, and so the quotient map $\pi : (B \otimes \Lambda W, \delta) \rightarrow (\Lambda W, \bar{d})$ is a quasi isomorphism (Lemma 14.2). Choose a morphism $\sigma : (\Lambda W, \bar{d}) \rightarrow (B \otimes \Lambda W, \delta)$ such that $\pi\sigma = id$ (Lifting lemma 12.4); then multiplication defines an isomorphism $id \cdot \sigma : (B, \delta) \otimes (\Lambda W, \bar{d}) \xrightarrow{\cong} (B \otimes \Lambda W, \delta)$, as follows by filtering using the degree of B .

Finally, dividing by \hat{b} gives a morphism $(B, \delta) \rightarrow (\Lambda b, 0)$ and

$$(\Lambda b \otimes_{\Lambda U} (\Lambda U \otimes \Lambda W, d) \cong \Lambda b \otimes_B B \otimes_A (A \otimes \Lambda W, \delta) \cong (\Lambda b, 0) \otimes (\Lambda W, \bar{d}) . \quad \square$$

We now return to the proof of Theorem 33.3, where we show that

- *Both $H(\Lambda W, \bar{d})$ and $H(\Lambda U, d)$ are finite dimensional.* (33.5)

Suppose (33.5) is proved. Filter $\Lambda U \otimes \Lambda W$ by setting $F^p(\Lambda U \otimes \Lambda W) = (\Lambda U)^{\geq p} \otimes \Lambda W$ and observe that the E_2 -term of the corresponding cohomology spectral sequence is given by $E_2^{p,q} = H^p(\Lambda U, d) \otimes H^q(\Lambda W, \bar{d})$. If p and q are the maximum degrees in which $H(\Lambda U, d)$ and $H(\Lambda W, \bar{d})$ are non-zero then for obvious degree reasons $d_i = 0$ in $E_i^{p,q}$, $i \geq 2$ and $E_i^{p,q} \cap \text{Im } d_i = 0$, $i \geq 2$. It follows that $E_\infty^{p,q} \neq 0$ and hence that $H^{p+q}(\Lambda U \otimes \Lambda W, d) \neq 0$. But $(\Lambda W, \bar{d})$ is a non-trivial minimal Sullivan model and $W = W^{\geq \ell}$ with $\ell \geq k + n_X > n_X$. This contradicts the hypothesis that $H^i(\Lambda U \otimes \Lambda W, d) = 0$, $i > n_X$, and establishes the theorem.

Now we have to prove (33.5). Fix a basis u_1, \dots, u_r of U such that $\text{deg } u_1 \leq \text{deg } u_2 \leq \dots$ and let $(\Lambda U_i \otimes \Lambda W, D_i)$ be the quotient Sullivan algebra obtained by

dividing by u_1, \dots, u_{i-1} . We show first by induction that each $H(\Lambda U_i \otimes \Lambda W, D_i)$ is finite dimensional so that, in particular, $H(\Lambda W, \bar{d})$ is finite dimensional.

Indeed suppose $H(\Lambda U_i \otimes \Lambda W, D_i)$ is finite dimensional. If $\deg u_i$ is even extend this to the Sullivan algebra $(\Lambda U_i \otimes \Lambda W \otimes \Lambda b, D_i)$ by setting $D_i b = u_i$, and note that this is quasi-isomorphic to $(\Lambda U_{i+1} \otimes \Lambda W, D_{i+1})$. Thus the long exact cohomology sequence associated with

$$0 \rightarrow (\Lambda U_i \otimes \Lambda W, D_i) \rightarrow (\Lambda U_i \otimes \Lambda W \otimes \Lambda b, D_i) \rightarrow (\Lambda U_i \otimes \Lambda W, D_i) \otimes (\mathbb{k}b, 0) \rightarrow 0$$

shows that $H(\Lambda U_{i+1} \otimes \Lambda W, D_{i+1})$ is finite dimensional.

On the other hand, if $\deg u_i$ is odd write $D_i(1 \otimes \Phi) = 1 \otimes D_{i+1}\Phi + u_i \otimes \theta\Phi$, $\Phi \in \Lambda U_{i+1} \otimes \Lambda W$. Let N be the maximum degree such that $H^N(\Lambda U_i \otimes \Lambda W, D_i) \neq 0$. If Φ is a D_{i+1} -cocycle representing $[\Phi] \in H(\Lambda U_{i+1} \otimes \Lambda W, D_{i+1})$ and if $\deg \Phi > N$ then $u_i \otimes \Phi$ is a D_i -cocycle and hence of the form $D_i(u_i \otimes \Psi + 1 \otimes \Phi_1)$. It follows that $D_{i+1}\Phi_1 = 0$ and $H(\theta)[\Phi_1] = [\Phi]$. This procedure constructs an infinite sequence $[\Phi] \leftarrow H(\theta)[\Phi_1] \leftarrow \dots$.

But division by $(u_j), j \neq i$ defines a surjection $(\Lambda U, d) \rightarrow (\Lambda u_i, 0)$. According to Lemma 33.4, $\Lambda u_i \otimes_{\Lambda U} (\Lambda U \otimes \Lambda W, d) \cong (\Lambda u_i, 0) \otimes (\Lambda W, \bar{d})$. It is immediate that if x_1, \dots, x_r is the dual basis of the homotopy Lie algebra L of $(\Lambda U, d)$ then the holonomy representation hl' of L in $H(\Lambda W, \bar{d})$ satisfies $hl'(x_i) = 0$ (Introduction to §31). Since L is finite dimensional $\text{ad } x_i$ is trivially nilpotent. Hence (Lemma 31.9) $H(\theta)$ is locally conilpotent and $[\Phi] = 0$; i.e. $H^{>N}(\Lambda U_{i+1} \otimes \Lambda W, D_{i+1}) = 0$. This shows that $H(\Lambda U_{i+1} \otimes \Lambda W, D_{i+1})$ is finite dimensional.

It remains to show that $H(\Lambda U, d)$ is finite dimensional and for this we lose no generality in assuming \mathbb{k} algebraically closed. Consider an arbitrary morphism $\varrho : (\Lambda U, d) \rightarrow (\Lambda b, 0)$ where $\deg b = 2$. It extends to a morphism $\pi : (\Lambda U \otimes \Lambda W, d) \rightarrow (\Lambda b, 0)$ defined as follows: use Lemma 33.4 to identify $\Lambda b \otimes_{\Lambda U} (\Lambda U \otimes \Lambda W, d)$ as $(\Lambda b, 0) \otimes (\Lambda W, \bar{d})$ and let π be the composite

$$(\Lambda U \otimes \Lambda W, d) \rightarrow \Lambda b \otimes_{\Lambda U} (\Lambda U \otimes \Lambda W, d) \rightarrow (\Lambda b, 0) .$$

Suppose now by induction that $\pi u_1 = \dots = \pi u_{i-1} = 0$. If $\deg u_i$ is odd then $\pi u_i = 0$. Otherwise factor π to give a morphism $\bar{\pi} : (\Lambda U_i \otimes \Lambda W, D_i) \rightarrow \Lambda b$. Since $H(\Lambda U_i \otimes \Lambda W, D_i)$ is finite dimensional and since $D_i u_i = 0$, it follows that $u_i^N = D_i \Omega$, some N . Hence $\pi(u_i^N) = \bar{\pi}(u_i^N) = \bar{\pi}(D_i \Omega) = 0$; and it follows that $\pi u_i = 0$. Thus $\varrho = 0$ in U and the only morphism $(\Lambda U, d) \rightarrow (\Lambda b, 0)$ is the trivial one. Now Proposition 32.3 asserts that $H(\Lambda U, d)$ is finite dimensional. This completes the proof of (32.5) and hence of the theorem. □

Proposition 33.6 (Lambrechts [104]) *Suppose X is as in Theorem 33.3. Then for r sufficiently large,*

$$\sum_{i=r+1}^{r+n_X-1} \dim \pi_i(X) \otimes \mathbb{Q} \geq \frac{\dim \pi_r(X) \otimes \mathbb{Q}}{\dim H^*(X; \mathbb{Q})} .$$

proof: Let $(\Lambda V, d)$ be the minimal Sullivan model of X and set

$$N = \dim H^*(X; \mathbb{Q}) = \dim H(\Lambda V, d).$$

If the inequality of the Proposition fails for some $r > n_X + 1$ we show by induction that for $0 \leq k \leq n_X - 1$, $(\Lambda V, d)$ can be decomposed as a relative Sullivan algebra of the form $(\Lambda U_k \otimes \Lambda W_k, d_k)$ in which $W_k = (W_k)^{\geq r}$, $(W_k)^i = 0$, $r + 1 \leq i \leq r + k$ and

$$\sum_{i=r+k+1}^{r+n_X-1} N \dim W^i < \dim W_k^r .$$

Since $V^k \cong \pi_k(X) \otimes \mathbb{Q}$, this can be achieved for $k = 0$ by setting $U_k = V^{< r}$. For the inductive step, let $w \in (W_k)^{r+k+1}$ and write $dw = \alpha w + \beta w$ with $\alpha w \in (\Lambda U_k) \otimes W_k^r$ and $\beta w \in \Lambda U_k$. Since $d^2 w = 0$ it follows that $\alpha w \in \ker d \otimes W_k^r$. Let $H(\alpha) : (W_k)^{r+k+1} \rightarrow H(\Lambda V) \otimes W_k^r$ be the induced map and write $W_k^r = Z \oplus Z'$ where Z is the smallest subspace such that $\text{Im } H(\alpha) \subset H(\Lambda V) \otimes Z$. Then by replacing a basis w_i of W^{r+k+1} by elements of the form $w'_i = w_i + \Phi_i$ with $\Phi_i \in \Lambda U_k \otimes Z'$ we may arrange that $\alpha : W^{r+k+1} \rightarrow \Lambda U_k \otimes (\mathbb{k} \oplus Z)$. Set $U_{k+1} = U_k \oplus Z \oplus (W_k)^{r+k+1}$ and set $W_{k+1} = Z' \oplus W_{k+1}^{\geq r+k+2}$. Since (clearly) $N \dim (W_k)^{r+k+1} \geq \dim Z$ it follows that $\sum_{i=r+k+2}^{r+n_X-1} N \dim W^i < \dim Z'$. This closes the induction.

For $k = n_X - 1$ we thus obtain a decomposition $(\Lambda V, d) = (\Lambda U \otimes \Lambda W, d)$ in which $W = W^{\geq r}$, $W^r \neq 0$ and $W^i = 0$, $r + 1 \leq i \leq n_X + r - 1$. Extend a non-zero linear function $f : W^r \rightarrow \mathbb{k}$ to a derivation θ in $(\Lambda U \otimes \Lambda W^r, d)$ by putting $\theta = 0$ in U . Suppose θ is further extended to $(\Lambda U \otimes \Lambda W^{\leq m}, d)$. If $w \in W^{m+1}$ then θdw is a cocycle of degree at least $n_X + 1$, and hence is a coboundary in ΛV . Thus we can extend θ to W^{m+1} so that $\theta dw = d\theta w$, $w \in W^{m+1}$.

This exhibits $f : W^r \rightarrow \mathbb{k}$ as a non-zero Gottlieb element (§29(d)) for $(\Lambda V, d)$. Since $\text{cat}(\Lambda V, d)$ is finite there are such elements in only finitely many degrees r (Proposition 29.8 (ii)), and hence the inequality of this Proposition holds for sufficiently large r . □

(c) Loop space homology.

For any topological space X with rational homology of finite type, the *Poincaré series* for X is the formal power series $P_X = \sum_0^\infty \dim H_n(X; \mathbb{Q}) z^n$. In particular, if X is simply connected the Milnor-Moore theorem 21.5 states that the loop space homology of X is isomorphic to the universal enveloping algebra of the homotopy Lie algebra $L_X : H_*(\Omega X; \mathbb{Q}) \cong UL_X$. Denote by r_i (or by $r_i(X)$ when the dependence on X is not clear from the context) the integers

$$r_i = \dim \pi_i(\Omega X) \otimes \mathbb{Q} = \dim \pi_{i+1}(X) \otimes \mathbb{Q} .$$

Then the Poincaré-Birkhoff-Witt theorem 21.1 identifies $P_{\Omega X}$ as the formal power

series

$$P_{\Omega X} = \frac{\prod_{i=0}^{\infty} (1 + z^{2i+1})^{r_{2i+1}}}{\prod_{i=1}^{\infty} (1 - z^{2i})^{r_{2i}}} \tag{33.7}$$

(Compare with the formula in §32(d) for P_X for certain rationally elliptic spaces!)

Note that (33.7) provides algorithms for computing the integers $\dim H_i(\Omega X; \mathbb{Q})$, $1 \leq i \leq N$ from the integers $\dim \pi_{i+1}(X) \otimes \mathbb{Q}$, $1 \leq i \leq N$ and for computing the integers $\dim \pi_{i+1}(X) \otimes \mathbb{Q}$, $1 \leq i \leq N$ from the integers $\dim H_i(\Omega X; \mathbb{Q})$, $1 \leq i \leq N$.

Proposition 33.8 *Suppose $H^i(X; \mathbb{Q}) = 0$, $i > n_X$. Then the integers $\dim H_i(\Omega X; \mathbb{Q})$, $1 \leq i \leq 3(n_X - 1)$ determine whether X is rationally elliptic or rationally hyperbolic.*

proof: Theorem 33.3 asserts that X is rationally elliptic if and only if $\pi_j(X) \otimes \mathbb{Q} = 0$, $2n_X \leq j < 3n_X - 1$. This only requires the calculation of r_i , $2n_X - 1 \leq i \leq 3n_X - 3$. □

Proposition 33.9

(i) *If X is rationally elliptic then there are constants $0 < A < B$ such that*

$$An^r \leq \sum_{i=0}^n \dim H_i(\Omega X; \mathbb{Q}) \leq Bn^r, \quad n \geq 1,$$

where $r = \dim \pi_{\text{odd}}(X) \otimes \mathbb{Q}$.

(ii) *If X is rationally hyperbolic and if $H^i(X; \mathbb{Q}) = 0$, $i > n_X$ then there are constants $C > 1$ and K such that*

$$\sum_{i=k+1}^{k+2(n_X-1)} \dim H_i(\Omega X; \mathbb{Q}) \geq C^k, \quad k \geq K.$$

proof: The first assertion is immediate from (33.7). For the second let $(\Lambda V, d)$ be the minimal Sullivan model of X . An element v of V of least degree is a cocycle of degree $n \leq n_X$. If n is even then v^p is a coboundary for some p such that $(p - 1)n \leq n_X$. Thus whether n is even or odd it follows that V has a non-zero element of odd degree $2k + 1 \leq 2n_X - 1$, and so L_X has an element of even degree $2k \leq 2n_X - 2$. By (33.7), $P_{\Omega X} = \frac{1}{1-z^{2k}} \sum_{i=2}^{\infty} r_i z^i$ is a power series with positive coefficients. Now apply Theorem 33.2. □

The *radius of convergence* R of a power series $\sum a_n z^n$ is the least upper bound of the nonnegative numbers r such that $\sum |a_n| r^n$ converges, and is given

by $R^{-1} = \limsup |a_n|^{1/n}$. Recall that X is supposed simply connected with rational homology of finite type.

Proposition 33.10 *The formal power series $P_{\Omega X}$ and $\sum r_n z^n$ have the same radius of convergence, R . Moreover*

- (i) $R = 1$ if X is rationally elliptic and $R < 1$ if X is rationally hyperbolic.
- (ii) If X is rationally hyperbolic and if $H^i(X; \mathbb{Q}) = 0, i > n_X$ then $R < K < 1$ for some constant K depending only on n_X .

proof: Write $\sum a_n z^n \ll \sum b_n z^n$ if $a_n \leq b_n$ for all n . Since

$$\sum r_n z^n \ll \frac{\prod_n (1 + z^{2n+1})^{r_{2n+1}}}{\prod_n (1 - z^{2n})^{r_{2n}}} \ll e^{\frac{\sum r_n z^n}{1-z}}$$

it follows by (33.7) that $\sum r_n z^n$ is convergent if and only if $P_{\Omega X}$ is convergent.

If X is rationally elliptic the products in (33.7) are finite and $R = 1$. If X is rationally hyperbolic let $\text{cat}_0 X = m$. The proof of Theorem 33.2 shows that given N sufficiently large there is an infinite sequence of integers N_i such that $N = N_0, N_i \leq N_{i+1} \leq (m + 1)N_i$ and

$$\left(\sum_{j=N_i}^{2N_i-2} \dim \pi_j(X) \otimes \mathbb{Q} \right)^{\frac{1}{N_i}} \geq \left(\frac{\sum_{j=N}^{2N-2} \dim \pi_j(X) \otimes \mathbb{Q}}{c_m^3} \right)^{\frac{1}{N}}$$

where c_m is a constant depending only on m . It is also shown that for N sufficiently large the right hand side is larger than one. It follows that $\limsup r_n^{1/n} > 1$. Moreover, Theorem 33.3 states that if $H^i(X; \mathbb{Q}) = 0, i > n_X$, then when $N = 2n_X c_{n_X}^3$ the right hand side is at least $2^{1/N}$, from which assertion (ii) follows at once. □

Example 1 *Wedges of spheres.*

Suppose $X = \bigvee_i S^{n_i+1}$ with $n_i \geq 1$ and at most finitely many spheres of a fixed degree. Then the homotopy Lie algebra is a free Lie algebra \mathbb{L}_V on a graded vector space with basis (v_i) and $\text{deg } v_i = n_i$ (Example 1, §24(e)). But $U\mathbb{L}_V$ is the tensor algebra TV (§21(c)) and thus

$$P_{\Omega X} = \frac{1}{1 - \sum_i z^{n_i}} \quad \square$$

Example 2 $X = S^3 \vee S^3$.

As in Example 1, $P_{\Omega X} = \frac{1}{1-2z^2}$ and hence $H_*(\Omega X; \mathbb{Q})$ is concentrated in even degrees. Thus formula (33.7) becomes

$$\frac{1}{1-2z^2} = \prod_n \frac{1}{(1-z^{2n})^{r_{2n}}}$$

where $r_{2n} = \dim \pi_{2n} \Omega(S^3 \vee S^3) \otimes \mathbb{Q}$. Take logs of both sides to obtain

$$\sum_k \frac{2^k z^{2k}}{k} = \sum_n r_{2n} \sum_k \frac{z^{2nk}}{k}$$

Equating the coefficients of z^{2N} gives $\sum_{d|N} r_{2d} d = 2^N$.

The Möbius function $\mu(n)$ is defined by: $\mu(n) = 1, (-1)^r$ or 0 as n is 1 , a product of r distinct primes or divisible by a prime squared. Elementary number theory gives

$$r_{2N} = \frac{1}{N} \sum_{d|N} \mu\left(\frac{N}{d}\right) 2^d$$

as a precise formula for the dimension of $\pi_{2N}(\Omega X) \otimes \mathbb{Q}$. As observed above, $\pi_{\text{odd}}(\Omega X) \otimes \mathbb{Q} = 0$. □

Example 3 $X = S_1^3 \vee S_2^3 \cup_{\{\alpha[\alpha,\beta]_w\}_w} D^8$.

Here α and β are the elements of $\pi_3(S_1^3 \vee S_2^3)$ represented by S_1^3 and S_2^3 , and $[-, -]_w$ is the Whitehead product. According to Example 4, §24(f) X has a Lie model of the form $(L, d) = (\mathbb{L}(v, w, u), d)$ with $\deg v = \deg w = 2$, $\deg u = 7$, $du = [v, [v, w]]$ and $dv = dw = 0$. In degrees ≤ 8 the cochain algebra $C^*(L, d)$ coincides with $(\Lambda(x_3, y_3, z_5, r_7, s_7, a_8), d)$ where x, y, z, r, s and a are dual (up to sign) respectively to $v, w, [v, w], [w, [w, v]], [v, [v, w]]$ and u , and where $dz = xy$ and $dr = yz, ds = xz - a$ and $da = 0$. Dividing by elements of degree > 8 , and by r and yz gives a commutative model for X of the form $(A, d) = (\Lambda(x, y, z), d) / (yz)$.

The quotient map $q : X \rightarrow S_1^3$ is represented by the inclusion $(\Lambda x, 0) \rightarrow (A, d)$. Extend this to a quasi-isomorphism from a relative Sullivan algebra, $(\Lambda x \otimes \Lambda V, d) \xrightarrow{\cong} (A, d)$. Since (A, d) is Λx -semifree this induces a quasi-isomorphism $\mathbb{k} \otimes_{\Lambda x} (\Lambda x \otimes \Lambda V, d) \xrightarrow{\cong} \mathbb{k} \otimes_{\Lambda x} (A, d)$ — Proposition 6.7 (ii). But $\mathbb{k} \otimes_{\Lambda x} (\Lambda x \otimes \Lambda V, d) = (\Lambda V, \bar{d})$ is a Sullivan model for the homotopy fibre F of q (Theorem 15.3), while $\mathbb{k} \otimes_{\Lambda x} (A, d) = (\Lambda(y, z)/yz, 0)$. This shows that

$$F \cong_{\mathbb{Q}} S^3 \vee S^5$$

Let $j : F \rightarrow X$ be the map corresponding to the fibre inclusion of the fibration associated with $q : X \rightarrow S_1^3$ and let $i : S_1^3 \rightarrow X$ be the inclusion. Since $qi = id$, $\Omega i \cdot \Omega j : \Omega S_1^3 \times \Omega F \rightarrow \Omega X$ is a weak homotopy equivalence. In particular, (cf. Example 2)

$$P_{\Omega X} = \frac{1}{1-z^2} \frac{1}{1-z^2-z^4}$$
□

Example 4 $X = T(S^3, S^3, S^3)$.

Recall that S^3 is a CW complex with a 0-cell and a 3-cell; thus the product $S^3 \times S^3 \times S^3$ has 8 cells consisting of a 0-cell, the three spheres, three 6-cells attached by Whitehead products and a 9-cell. The 6-skeleton of $S^3 \times S^3 \times S^3$ is called the *fat wedge* $T(S^3, S^3, S^3)$.

The inclusion $q : X \rightarrow S^3 \times S^3 \times S^3$ can be represented by $\varphi : (\Lambda(x, y, z), 0) \rightarrow (A, d)$ where A is a commutative model concentrated in degrees ≤ 6 . It follows that $A = \Lambda(x, y, z)/xyz$.

If we extend φ to a quasi-isomorphism $(\Lambda(x, y, z) \otimes \Lambda V, d) \xrightarrow{\cong} (A, d)$ from a relative Sullivan algebra then, as in Example 3, the quotient Sullivan algebra $(\Lambda V, \bar{d})$ is a Sullivan model for the homotopy fibre F of q . But there are quasi-isomorphisms $(\Lambda V, \bar{d}) \simeq (\Lambda(x, y, z) \otimes \Lambda V \otimes \Lambda(\bar{x}, \bar{y}, \bar{z}), d) \cong (A \otimes \Lambda(\bar{x}, \bar{y}, \bar{z}), d)$, where $d\bar{x} = x, d\bar{y} = y$ and $d\bar{z} = z$.

Consider the short exact sequence

$$0 \rightarrow \mathbb{k}xyz \otimes \Lambda(\bar{x}, \bar{y}, \bar{z}) \rightarrow \Lambda(x, y, z) \otimes \Lambda(\bar{x}, \bar{y}, \bar{z}) \rightarrow A \otimes \Lambda(\bar{x}, \bar{y}, \bar{z}) \rightarrow 0 .$$

Since the central term is contractible it follows that every cohomology class in $H(A \otimes \Lambda(\bar{x}, \bar{y}, \bar{z}))$ is represented by a cocycle in $\Lambda^2(x, y, z) \otimes \Lambda(\bar{x}, \bar{y}, \bar{z})$. The product of two such cocycles is zero and it follows that F is formal and thus has the rational homotopy type of a wedge of spheres (Proposition 13.12 and Theorem 24.5). The long exact cohomology sequence also shows that $P_F = \frac{z^8}{(1-z^2)^3}$. Thus (Example 1)

$$P_{\Omega F} = \frac{1}{1 - z^7/(1 - z^2)^3} = \frac{(1 - z^2)^3}{(1 - z^2)^3 - z^7} .$$

Since $\pi_*(q)$ is (trivially) surjective it follows that

$$P_{\Omega X} = \frac{1}{(1 - z^2)^3 - z^7} .$$

It follows in particular that $\dim \pi_3(X) \otimes \mathbb{Q} = 3, \dim \pi_8(X) \otimes \mathbb{Q} = 1$ and that $\pi_i(X) \otimes \mathbb{Q} = 0, 4 \leq i \leq 7$. This interval of four consecutive zero rational homotopy groups is the maximum allowed by Theorem 33.3, since $H^i(X; \mathbb{Q}) = 0, i > 6$. □

Example 5 $X = Y \vee Z$.

Suppose Y and Z are simply connected CW complexes. Let $j : F \rightarrow Y \vee Z$ be the ‘inclusion’ of the homotopy fibre of the inclusion $q : Y \vee Z \rightarrow Y \times Z$. The construction of F (§2(c)) identifies it as $F = \Omega Y \times PZ \bigcup_{\Omega Y \times \Omega Z} PY \times \Omega Z$. Since the pairs $(PY, \Omega Y)$ and $(C\Omega Y, \Omega Y)$ are homotopy equivalent (elementary), and similarly for Z we have

$$F \simeq \Omega Y \times C\Omega Z \bigcup_{\Omega Y \times \Omega Z} C\Omega Y \times \Omega Z \cong \Omega Y * \Omega Z \simeq \Sigma(\Omega Y \wedge \Omega Z) ,$$

((1.15) and Proposition 1.17 — note that $(\Omega Y, pt)$ and $(\Omega Z, pt)$ are well based by Step 1 of Proposition 27.9). This shows that F has the rational homotopy type of a wedge of spheres (Theorem 24.5).

Now since $F \simeq \sum(\Omega Y \wedge \Omega Z)$, $P_F(z) = z(P_{\Omega Y} - 1)(P_{\Omega Z} - 1)$. Thus (Example 1) since $\pi_*(q)$ is clearly surjective,

$$P_{\Omega F} = \frac{1}{1 - (P_{\Omega Y} - 1)(P_{\Omega Z} - 1)} \quad \text{and} \quad P_{\Omega X} = \frac{P_{\Omega Y} P_{\Omega Z}}{1 - (P_{\Omega Y} - 1)(P_{\Omega Z} - 1)} .$$

Simplifying gives the classical formula

$$P_{\Omega(Y \vee Z)}^{-1} = P_{\Omega Y}^{-1} + P_{\Omega Z}^{-1} - 1 . \quad \square$$

Exercises

1. Let X be a simply connected CW complex of finite type. Suppose that $\pi_r(X) \otimes \mathbb{Q} = 0$ for $r > n$, and $H^p(X; \mathbb{Q}) = 0$ for $n < p < 2n + 1$. Prove that $H^p(X; \mathbb{Q}) = 0$ for $p > n$.

2. Denote by R the radius of convergence of the series $\sum_n \dim H_n(\Omega X; \mathbb{Q}) z^n$. If X is a hyperbolic space prove that for large r and for any $\varepsilon > 0$, we have

$$\sum_{n=0}^r \dim \pi_n(X) \otimes \mathbb{Q} \geq \left[\frac{1}{(R + \varepsilon)} \right]^{\frac{r}{2(m+1)^2}} ,$$

where $m = \text{cat}_0 X$.

3. Let R_X be the radius of convergence of $H_*(\Omega X; \mathbb{Q})[z]$ and $P(z)$ the Poincaré series of $H_*(X; \mathbb{Q})$. Suppose that $\dim H_*(X; \mathbb{Q}) < \infty$. Prove that $R_X \geq \min\{|z|, z \neq 0 \text{ and } z - P(z) + 1 = 0\}$.

34 The Hochschild-Serre spectral sequence

In this section the ground ring is an arbitrary field \mathbb{k} of characteristic zero.

In this section we fix a graded Lie algebra, $L = \{L_i\}_{i \in \mathbb{Z}}$, with universal enveloping algebra UL . If M is a left (right) UL -module then restriction of the action of UL to L defines a left (right) representation of L in M , and this correspondence is a bijection (§21(a)). We use this to *identify L -modules as UL -modules and conversely*. In particular, the trivial representation of L in \mathbb{k} defines a canonical (left and right) UL -module structure in \mathbb{k} .

Now suppose $I \subset L$ is an ideal and N is a right L -module. Restriction to I makes N into a right I -module, and so the graded vector spaces $\text{Ext}_{UI}^k(\mathbb{k}, N)$ are defined (§20(b)) via any UI -projective resolution of \mathbb{k} . It turns out (§34(a)) that the L -module structure in N makes each $\text{Ext}_{UI}^k(\mathbb{k}, N)$ into a right L/I -module. Thus if M is any right L/I -module the graded vector spaces

$$\text{Ext}_{UL/I}^p(M, \text{Ext}_{UI}^q(\mathbb{k}, N))$$

are defined.

On the other hand, the quotient map $L \rightarrow L/I$ makes M into a right L -module. The main objective of this section is to construct a spectral sequence, due to Hochschild and Serre [92], which converges from

$$E_2^{p,q} = \text{Ext}_{UL/I}^p(M, \text{Ext}_{UI}^q(\mathbb{k}, N)) \implies \text{Ext}_{UL}^{p+q}(M, N).$$

The case $N = UL$ will be of particular importance in the applications.

The key notion in this section is that of a *chain complex of UL -modules*. Recall from the introduction to §20 that this is a complex of the form

$$0 \longleftarrow P_{0,*} \xleftarrow{d} P_{1,*} \xleftarrow{d}$$

in which each $P_{i,*}$ is a (graded) UL -module with $(P_{i,*})_j = P_{i,j-i}$, and d is homogeneous of bidegree $(-1, 0)$. We shall adopt the

Notation convention: A chain complex of UL -modules will be denoted by $P_* = \{P_i\}$, with P_i denoting the UL -module $P_{i,*}$. If N is a UL -module then $\text{Hom}_{UL}(P_*, N)$ denotes the complex

$$0 \longrightarrow \text{Hom}_{UL}(P_0, N) \xrightarrow{\delta} \text{Hom}_{UL}(P_1, N) \xrightarrow{\delta} \dots$$

of graded vector spaces with δ homogeneous of degree 1 (bidegree $(1, 0)$).

This section is organized into the following topics

- (a) Hom, Ext, tensor and Tor for UL -modules.
- (b) The Hochschild-Serre spectral sequence.
- (c) Coefficients in UL .

(a) Hom, Ext, tensor and Tor for UL -modules.

Let M and N be right L -modules. A natural right L -module structure in $\text{Hom}(M, N)$ is then defined by

$$(f \cdot x)(m) = (-1)^{\deg x \deg m} (f(m) \cdot x - f(m \cdot x)) , \quad \begin{matrix} f \in \text{Hom}(M, N), \\ x \in L, m \in M . \end{matrix}$$

Clearly for any ideal $I \subset L$,

$$\text{Hom}_{UI}(M, N) = \{ f \in \text{Hom}(M, N) \mid f \cdot x = 0, x \in I \} .$$

Thus $\text{Hom}_{UI}(M, N)$ is a sub L -module in which I acts trivially; i.e., it is an L/I -module

In particular, let $P_* \xrightarrow{\cong} M$ be a UL -projective resolution (§20(a)). The Corollary to Proposition 21.2 implies that P_* is also UI -projective, and so $\text{Ext}_{UI}(M, N) = H(\text{Hom}_{UI}(P_*, N))$. But the remarks above identify $\text{Hom}_{UI}(P_*, N)$ as a complex of L/I -modules, which endows $H(\text{Hom}_{UI}(P_*, N))$ with a right L/I -module structure. Moreover, given a second such resolution $Q_* \rightarrow M$, the unique homotopy class of L -linear quasi-isomorphisms $Q_* \xrightarrow{\cong} P_*$ inducing the identity in M induce L/I -linear quasi-isomorphisms $\text{Hom}_{UI}(P_*, N) \xrightarrow{\cong} \text{Hom}_{UI}(Q_*, N)$. Thus the identification $H(\text{Hom}_{UI}(P_*, N)) = H(\text{Hom}_{UI}(Q_*, N))$ is an identification of L/I -modules and so this endows each $\text{Ext}_{UI}^k(M, N)$ with the structure of right L/I -module.

Definition The L/I -module structure above is called the *canonical L/I -structure* in $\text{Ext}_{UI}(M, N)$.

Again consider two right L -modules M and N . As with $\text{Hom}(M, N)$, the tensor product $M \otimes N$ inherits a right L -module structure:

$$(m \otimes n) \cdot x = (-1)^{\deg n \deg x} m \cdot x \otimes n + m \otimes n \cdot x , \quad x \in L, m \in M, n \in N .$$

As usual, let $(M \otimes N) \cdot L$ denote the subspace spanned by the elements $(m \otimes n) \cdot x$.

Lemma 34.1 *If M or N is UL -free then $M \otimes N$ is UL -free.*

proof: Suppose N is UL -free on a basis a_α . Since $M \otimes N = \bigoplus_\alpha M \otimes (a_\alpha \cdot UL)$ it is sufficient to prove that $M \otimes UL$ is UL -free. Let $F_p \subset UL$ be the linear span of elements of the form $x_{i_1} \cdots x_{i_q}$, $x_{i_q} \in L$, $q \leq p$. If $m \in M$ and $a \in F_p$ then $(m \otimes 1) \cdot a - m \otimes a \in M \otimes F_{p-1}$. It follows that $M \otimes UL$ is UL -free on a basis $m_\lambda \otimes 1$ where m_λ is any k -basis of M .

The proof when M is UL -free is identical. □

Next observe that a left L -module structure in N is defined by

$$x \cdot n = -(-1)^{\deg x \deg n} n \cdot x , \quad n \in N, x \in L .$$

Moreover, $(M \otimes N) \cdot L$ is the kernel of the surjection $M \otimes N \rightarrow M \otimes_{UL} N$ and of the surjection $M \otimes N \rightarrow (M \otimes N) \otimes_{UL} \mathbb{k}$. This provides a natural identification

$$M \otimes_{UL} N = (M \otimes N) \otimes_{UL} \mathbb{k} . \tag{34.2}$$

Furthermore, if $I \subset L$ is an ideal then $(M \otimes N) \cdot I$ is an L -module and so the quotient $M \otimes_{UI} N = (M \otimes N) \otimes_{UI} \mathbb{k}$ inherits a natural structure of right L/I -module.

Recall (§3(a)) that we denote $\text{Hom}(-, \mathbb{k})$ simply by $(-)^{\sharp}$.

Lemma 34.3 *Suppose M and N are right L -modules and that $I \subset L$ is an ideal.*

- (i) *Each $\text{Tor}_k^{UI}(M, N)$ is naturally a right L/I -module.*
- (ii) *There are natural isomorphisms $\text{Tor}_k^{UI}(M, N) \cong \text{Tor}_k^{UI}(M \otimes N, \mathbb{k})$ of L/I -modules.*
- (iii) *There are natural isomorphisms $\text{Ext}_{UI}^k(M, N^{\sharp}) \cong \text{Tor}_k^{UI}(M, N)^{\sharp}$ of L/I -modules.*

proof: Let $P_* \rightarrow M$ be a UL -projective resolution (§20(a)). It is UI -projective by the Corollary to Proposition 21.2.

(i) Note that $\text{Tor}^{UI}(M, N)$ is the homology of the complex $P_* \otimes_{UI} N$ of right L/I -modules.

(ii) Note that $P_* \otimes N \xrightarrow{\cong} M \otimes N$ is a UL -projective resolution (Lemma 34.1) and hence that $\text{Tor}^{UI}(M \otimes N, \mathbb{k}) = H((P_* \otimes N) \otimes_{UI} \mathbb{k})$. But $(P_* \otimes N) \otimes_{UI} \mathbb{k} = P_* \otimes_{UI} N$ as L/I -modules.

(iii) Write $\text{Tor}_*^{UI}(M, N)^{\sharp} = \{ \text{Tor}_k^{UI}(M, N)^{\sharp} \}$ and $(P_* \otimes_{UI} N)^{\sharp} = \{ (P_k \otimes_{UI} N)^{\sharp} \}$. But clearly $\text{Hom}(M \otimes_{UI} N, \mathbb{k}) = \text{Hom}_{UI}(M, N^{\sharp})$, and since \mathbb{k} is a field it follows that

$$\text{Tor}_*^{UI}(M, N)^{\sharp} = H((P_* \otimes_{UI} N)^{\sharp}) = H(\text{Hom}_{UI}(P_*, N^{\sharp})) = \text{Ext}_{UI}^*(M, N^{\sharp}) .$$

Example 1 $\text{Tor}_1^{UI}(\mathbb{k}, \mathbb{k}) \cong s(I/[I, I])$.

Again let $I \subset L$ be an ideal. Denote by $[I, I]$ the ideal in L which is the linear span of the elements $[y, z]$, $y, z \in I$. If $x \in I$ denote by (x) the image of sx in the suspension $s(I/[I, I])$. We shall establish an isomorphism

$$\text{Tor}_1^{UI}(\mathbb{k}, \mathbb{k}) \cong s(I/[I, I])$$

and show that the representation of L/I in $\text{Tor}_1^{UI}(\mathbb{k}, \mathbb{k})$ corresponds under this isomorphism to the representation

$$(x) \cdot y = (-1)^{\text{deg } y}([x, y]) .$$

In fact, in §22(b) we constructed a UI -free resolution P_* (Propositions 22.3 and 22.4) of \mathbb{k} explicitly, of the form

$$\mathbb{k} \longleftarrow UI \xleftarrow{d} sI \otimes UI \xleftarrow{d} \Lambda^2 sI \otimes UI \xleftarrow{d} \dots$$

Apply $-\otimes_{UI} \mathbb{k}$ and note from the definition that in this quotient $d(sx \wedge sy) = (-1)^{\deg sx} s[x, y]$. Thus

$$\text{Tor}_1^{UI}(\mathbb{k}, \mathbb{k}) = sI/d\Lambda^2 sI = s(I/[I, I])$$

Exactly the same way we have a UL -free resolution Q_* of \mathbb{k} of the form

$$\mathbb{k} \longleftarrow UL \xleftarrow{d} sL \otimes UL \xleftarrow{d} \Lambda^2 sL \otimes UL \xleftarrow{d} \dots$$

and the inclusion of P_* in Q_* is a quasi-isomorphism. Let $x \in I$ and $y \in L$. Then the formula for d in §22(b) gives

$$d(sx \wedge sy \otimes 1) = (-1)^{\deg sx + \deg sy} sx \otimes y \pm sy \otimes x + (-1)^{\deg sx} s[x, y] \otimes 1$$

Applying $\otimes_{UI} \mathbb{k}$ kills $sy \otimes x$, while $sx \otimes y = (sx \otimes 1) \cdot y$. Thus in homology we have

$$(x) \cdot y = (-1)^{\deg y} ([x, y]), \quad x \in I, y \in L \quad \square$$

Example 2 *The representation of L/I in $\text{Tor}_q^{UI}(\mathbb{k}, \mathbb{k})$.*

As in Example 1 the inclusion of P_* in Q_* is a quasi-isomorphism of UI -free resolutions of \mathbb{k} , and in particular applying $-\otimes_{UI} \mathbb{k}$ gives a quasi-isomorphism $(\Lambda sI, \bar{d}) \xrightarrow{\cong} Q_* \otimes_{UI} \mathbb{k}$. Let $a \in \Lambda^q sI$ be a cycle (representing a class $\alpha \in \text{Tor}_q^{UI}(\mathbb{k}, \mathbb{k})$) and let $y \in L$. Then the formulae of §22(b) show that in $Q_* \otimes_{UI} \mathbb{k}$,

$$\bar{d}(a \wedge sy \otimes 1) = a \cdot y \otimes 1 + (-1)^{\deg a} a \otimes y$$

where $a \cdot y$ is defined by

$$(sx_1 \wedge \dots \wedge sx_q) \cdot y = (-1)^{\deg(sx_1 \wedge \dots \wedge sx_q)} \sum_{i=1}^q (-1)^{\deg y \deg(sx_{i+1} \wedge \dots \wedge sx_q)} sx_1 \wedge \dots \wedge s[x_i, y] \wedge \dots \wedge sx_q$$

It follows that the representation of L/I in $\text{Tor}_q^{UI}(\mathbb{k}, \mathbb{k})$ is given by

$$\alpha \cdot y = (-1)^{\deg \alpha + 1} [a \cdot y] \quad \square$$

(b) The Hochschild-Serre spectral sequence.

In this topic we construct the spectral sequence. Fix an ideal $I \subset L$ and a right L/I -module M and a right L -module N . For any graded vector space S an isomorphism

$$\varphi : \text{Hom}(M \otimes S, N) \xrightarrow{\cong} \text{Hom}(M, \text{Hom}(S, N))$$

is given by $\varphi f(m)(s) = f(m \otimes s)$, $f \in \text{Hom}(M \otimes S, N)$.

Lemma 34.4 *If S is a right L -module then φ restricts to an isomorphism*

$$\text{Hom}_{UL}(M \otimes S, N) \xrightarrow{\cong} \text{Hom}_{UL/I}(M, \text{Hom}_{UI}(S, N)) .$$

proof: It is immediate that φ is L -linear. Thus if $f \in \text{Hom}_{UL}(M \otimes S, N)$ we have $f \cdot x = 0$, $x \in L$ and so $(\varphi f) \cdot x = 0$. Thus φf is L -linear. For $x \in I$ and $m \in M$ it follows that $(\varphi f)(m) \cdot x = \varphi f(m \cdot x) = 0$. Thus $\varphi f(m)$ is I -linear; i.e. $\varphi : \text{Hom}_{UL}(M \otimes S, N) \rightarrow \text{Hom}_{UL/I}(M, \text{Hom}_{UI}(S, N))$. Conversely if $f \in \text{Hom}(M \otimes S, N)$ and if $\varphi f \in \text{Hom}_{UL/I}(M, \text{Hom}_{UI}(S, N))$ then φf is L -linear and hence so is f . \square

Now we construct the spectral sequence. Choose a UL/I -free resolution $\varepsilon_M : P_* \xrightarrow{\cong} M$ and a UL -free resolution $\varepsilon : Q_* \rightarrow \mathbb{k}$. Denote the tensor product of these two complexes by $(R_*, d) = (P_*, d) \otimes (Q_*, d) : R_k = \bigoplus_{p+q=k} P_p \otimes Q_q$. (Note as in §20(a) that each P_p and Q_q is itself a graded vector space!) Observe that

- Each R_k is a free UL -module (Lemma 34.1).
- $\varepsilon_M \otimes \varepsilon : R_* \xrightarrow{\cong} M$ is a UL -free resolution (because \mathbb{k} is a field).

Now $\text{Ext}_{UL}^*(M, N)$ is the homology of the complex $\text{Hom}_{UL}(R_*, N)$ and this is in fact a bigraded complex with

$$\text{Hom}_{UL}^k(R_*, N) = \bigoplus_{p+q=k} \text{Hom}_{UL}(P_p \otimes Q_q, N) .$$

Refer to k as the *total homological degree* to distinguish it from the ‘normal’ degree inherent in the fact that N and R_k are each graded vector spaces.

Filter the complex $\text{Hom}_{UL}(R_*, N)$ by the subspaces $\bigoplus_{i \geq p} \text{Hom}_{UL}(P_i \otimes Q_*, N)$.

Use this and the total homological degree to obtain a first quadrant cohomology spectral sequence, convergent to $\text{Ext}_{UL}(M, N)$ and with

$$E_0^{p,q} = \text{Hom}_{UL}(P_p \otimes Q_q, N) .$$

Lemma 34.4 identifies $\text{Hom}_{UL}(P_p \otimes Q_q, N) = \text{Hom}_{UL/I}(P_p, \text{Hom}_{UI}(Q_q, N))$. The differential d_0 is induced from the differential in Q_* . Thus because each P_p is UL/I -projective we have

$$\begin{aligned} E_1^{p,q} &= H^q(\text{Hom}_{UL/I}(P_p, \text{Hom}_{UI}(Q_*, N))) \\ &= \text{Hom}_{UL/I}(P_p, H^q(\text{Hom}_{UI}(Q_*, N))) \\ &= \text{Hom}_{UL/I}(P_p, \text{Ext}_{UI}^q(\mathbb{k}, N)) , \end{aligned}$$

where $\text{Ext}_{UI}^q(\mathbb{k}, N)$ is equipped with its canonical right L/I -module structure.

The differential, d_1 , is then induced from the differential in P_* , so that

$$E_2^{p,q} = \text{Ext}_{UL/I}^p(M, \text{Ext}_{UI}^q(\mathbb{k}, N)) .$$

It is immediate that this spectral sequence is independent of the choice of resolutions P_* and Q_* and so we may make the definition:

The spectral sequence above, converging from $\text{Ext}_{UL/I}^p(M, \text{Ext}_{UI}^q(\mathbb{k}, N))$ to $\text{Ext}_{UL}^{p+q}(M, N)$ is called the *Hochschild-Serre spectral sequence*.

Remark If I acts trivially in N then the E_2 -term of the Hochschild-Serre spectral sequence may be identified as

$$E_0^{p,q} = \text{Ext}_{UL/I}^p(M \otimes \text{Tor}_q^{UI}(\mathbb{k}, \mathbb{k}), N) ,$$

where $\text{Tor}_q^{UI}(\mathbb{k}, \mathbb{k})$ has the UL/I structure of Lemma 34.3(i).

In fact in this case

$$\begin{aligned} E_0^{p,q} = \text{Hom}_{UL}(P_p \otimes Q_q, N) &= \text{Hom}_{UL/I}(P_p \otimes_{UL} Q_q, N) \\ &= \text{Hom}_{UL/I}(P_p \otimes (\mathbb{k} \otimes_{UI} Q_q), N) . \end{aligned}$$

This identifies

$$E_1^{p,q} = \text{Hom}_{UL/I}(P_p \otimes \text{Tor}_q^{UI}(\mathbb{k}, \mathbb{k}), N)$$

with L/I acting diagonally in $P_* \otimes \text{Tor}_*^{UI}(\mathbb{k}, \mathbb{k})$. By Lemma 34.1 the differential in P_* makes $P_* \otimes \text{Tor}_*^{UI}(\mathbb{k}, \mathbb{k})$ into a UL/I -free resolution of $M \otimes \text{Tor}_*^{UI}(\mathbb{k}, \mathbb{k})$. This gives

$$E_2^{p,q} = \text{Ext}_{UL/I}^p(M \otimes \text{Tor}_q^{UI}(\mathbb{k}, \mathbb{k}), N) ,$$

as desired.

(c) Coefficients in UL .

In this topic we suppose that the graded Lie algebra L satisfies:

$$L = L_{\geq 1} \text{ and each } L_i \text{ is finite dimensional.}$$

It follows from this that UL is a graded vector space of finite type.

Let $I \subset L$ be an ideal and choose a graded subspace $W \subset UL$ so that multiplication in UL defines an isomorphism $W \otimes UI \xrightarrow{\cong} UL$ of right UI modules (Corollary to Proposition 21.2). The proof of the Corollary shows that the surjection $UL \rightarrow UL/I$ restricts to a linear isomorphism $W \xrightarrow{\cong} UL/I$. In particular, this endows W with the structure of right L/I -module.

Now let M be any graded vector space of the form $M = \{M_i\}_{i \geq 0}$. Since each W_k is finite dimensional a natural isomorphism

$$W_k \otimes \text{Hom}(M, UI) \xrightarrow{\cong} \text{Hom}(M, W_k \otimes UI)$$

is given by $w \otimes g \mapsto h$, with $h(m) = w \otimes g(m)$. Thus an isomorphism

$$\text{Hom}(M, UL) \xrightarrow{\cong} \prod_k W_k \otimes \text{Hom}(M, UI)$$

is defined by $f \mapsto (f_k)$, where for $m \in M$, $f_k(m)$ is the component of $f(m)$ in $W_k \otimes UI$. (Note that given any $m \in M$ and any sequence $f_k \in W_k \otimes \text{Hom}(M, UI)$ of degree p we have $f_k(m) \in W_k \otimes UI_{\text{deg } m + p - k}$. Thus $f_k(m) = 0$, $k > \text{deg } m + p$ and the sum $\sum f_k(m)$ is finite.)

Now suppose M is a right L -module. The isomorphism above then restricts to an isomorphism

$$\varphi : \text{Hom}_{UI}(M, UL) \xrightarrow{\cong} \prod_k W_k \otimes \text{Hom}_{UI}(M, UI) .$$

The infinite product contains the direct sum $\bigoplus_k W_k \otimes \text{Hom}_{UI}(M, UI)$ as a subspace, and this is just $W \otimes \text{Hom}_{UI}(M, UI)$.

Recall from §34(a) that $\text{Hom}_{UI}(M, UL)$ is a right L/I -module. Thus $\prod_k W_k \otimes \text{Hom}_{UI}(M, UI)$ inherits a right L/I -module structure via φ , while W has a right L/I -module structure through the isomorphism $W \xrightarrow{\cong} UL/I$.

Note that the inclusion $W \otimes \text{Hom}_{UI}(M, UI) \rightarrow \prod_k W_k \otimes \text{Hom}_{UI}(M, UI)$ identifies each $W_k \otimes \text{Hom}_{UI}(M, UI)$ as a subspace of the infinite product. A simple calculation gives

Lemma 34.5 *If $x \in L/I$, $w \in W_k$ and $f \in \text{Hom}_{UI}(M, UI)$ then*

$$(w \otimes f) \cdot x - (-1)^{\text{deg } f \text{ deg } x} w \cdot x \otimes f \in W_{<k} \otimes \text{Hom}_{UI}(M, UI) .$$

Now let $\varepsilon : P_* \xrightarrow{\cong} \mathbb{k}$ be a UL -projective resolution of \mathbb{k} . Recall (§34(a)) that the canonical L/I -module structure in $\text{Ext}_{UI}^p(\mathbb{k}, UL)$ is obtained by identifying $\text{Ext}_{UI}(\mathbb{k}, UL) = H(\text{Hom}_{UI}(P_*, UL))$ and using the L/I -module structure induced from that in $\text{Hom}_{UI}(P_*, UL)$.

As above, identify

$$\text{Hom}_{UI}(P_*, UL) = \prod_k W_k \otimes \text{Hom}_{UI}(P_*, UI)$$

and hence identify

$$\text{Ext}_{UI}^q(\mathbb{k}, UL) = \prod_k W_k \otimes \text{Ext}_{UI}^q(\mathbb{k}, UI) .$$

Lemma 34.5 then implies that for $x \in L/I$, $w \in W_k$ and $\alpha \in \text{Ext}_{UI}^q(\mathbb{k}, UI)$ we have

$$(w \otimes \alpha) \cdot x - (-1)^{\deg \alpha \deg x} w \cdot x \otimes \alpha \in W_{<k} \otimes \text{Ext}_{UI}^q(\mathbb{k}, UI) . \quad (34.6)$$

It follows that $W \otimes \text{Ext}_{UI}^q(\mathbb{k}, UI)$ is an L/I -submodule of the infinite product.

Proposition 34.7

- (i) $W \otimes \text{Ext}_{UI}^q(\mathbb{k}, UI)$ is a free UL/I -module on $1 \otimes \text{Ext}_{UI}^q(\mathbb{k}, UI)$.
- (ii) If either UL/I or $\text{Ext}_{UI}^q(\mathbb{k}, UI)$ is finite dimensional then

$$W \otimes \text{Ext}_{UI}^q(\mathbb{k}, UI) = \text{Ext}_{UI}^q(\mathbb{k}, UL) .$$

proof: Denote $\text{Ext}_{UI}^q(\mathbb{k}, UI)$ by E^q .

(i) An L/I -linear map θ from the free L/I -module $E^q \otimes UL/I$ to $W \otimes E^q$ is given by

$$\theta(\Phi \otimes a) = (1 \otimes \Phi) \cdot a , \quad \Phi \in E^q, a \in UL/I .$$

(We identify $UL/I = W$.) It follows from formula (34.6) that $\theta(\Phi \otimes a) - (-1)^{\deg \Phi \deg a} a \otimes \Phi \in W_{<\deg a} \otimes E^q$. This implies that θ is an isomorphism.

(ii) If either UL/I or E^q is finite dimensional then

$$W \otimes E^q = \bigoplus_k W_k \otimes E^q = \prod_k W_k \otimes E^q = \text{Ext}_{UI}^q(\mathbb{k}, UL) . \quad \square$$

Recall again, that L is a graded Lie algebra satisfying $L = \{L_i\}_{i \geq 1}$ and each L_i is finite dimensional. Suppose further that

- $I \subset L$ is an ideal and that N is an L -module.

Write $UL = W \otimes UI$ as above. Then $(UL)^\# = (UI)^\# \otimes W^\#$ and

$$\text{Tor}_q^{UI}(N, (UL)^\#) = \text{Tor}_q^{UI}(N, (UI)^\#) \otimes W^\# . \quad (34.8)$$

The surjection $UL \rightarrow UL/I$ restricts to an isomorphism $W \xrightarrow{\cong} UL/I$, which dualizes to $(UL/I)^\# \xrightarrow{\cong} W^\#$ and so makes $W^\#$ into an L/I module. Thus the left hand side of (34.8) is an L/I -module because N is an L -module (Lemma 34.3) and the right hand side is an L/I -module via the action in $W^\#$.

However, (34.8) is usually NOT an isomorphism of L/I -modules. Even so, it is often possible to construct an isomorphism that does preserve the L/I -module structure, as the next proposition shows. Recall (Lemma 34.3) that each $\text{Tor}_q^{UI}(N, \mathbb{k})$ is an L/I -module.

Proposition 34.9 *With the hypotheses and notation above assume the Lie algebra L/I is finitely generated and that $\alpha \cdot UL/I$ is finite dimensional for each $\alpha \in \text{Tor}_q^{UI}(N, \mathbb{k})$. Then there is an isomorphism of UL/I -modules*

$$\text{Tor}_q^{UI}(N, (UL)^\sharp) \cong \text{Tor}_q^{UI}(N, (UI)^\sharp) \otimes (UL/I)^\sharp$$

where L/I acts on the right via the action in $(UL/I)^\sharp$. In particular,

$$\text{Tor}_p^{UL/I}(\mathbb{k}, \text{Tor}_q^{UI}(N, (UL)^\sharp)) \cong \text{Tor}_p^{UL/I}(\mathbb{k}, (UL/I)^\sharp) \otimes \text{Tor}_q^{UI}(N, (UI)^\sharp) .$$

Lemma 34.10 *With the hypotheses of Proposition 34.9, $\beta \cdot UL/I$ is finite dimensional for all $\beta \in \text{Tor}_q^{UI}(N, (UL)^\sharp)$.*

proof: Write $M = (UL)^\sharp$. Then $M = M_{\leq 0}$ is the union of the submodules $M_{\geq -p}$. It is thus sufficient to prove the lemma for $\beta \in \text{Tor}_q^{UI}(N, M_{\geq -p})$. Consider the exact sequence

$$\text{Tor}_q^{UI}(N, M_{> -p}) \longrightarrow \text{Tor}_q^{UI}(N, M_{\geq -p}) \longrightarrow \text{Tor}_q^{UI}(N, M_{-p}) ,$$

where UL acts trivially in M_{-p} . By hypothesis the lemma holds for this trivial UL -module. Hence for $\beta \in \text{Tor}_q^{UI}(N, M_{\geq -p})$ and some $n \geq 0$, $\beta \cdot (UL/I)_{\geq n} \subset \text{Image } \text{Tor}_q^{UI}(N, M_{> -p})$. Because L/I is a finitely generated Lie algebra each $(UL/I)_{\geq n}$ is a finitely generated UL/I -module. Hence so is $\beta \cdot (UL/I)_{\geq n}$. By induction on p it follows that $\beta \cdot (UL/I)_{\geq n}$ is finite dimensional. Hence so is $\beta \cdot UL/I$. \square

proof of Proposition 34.9: Dualize the inclusion $UI \rightarrow UL$ to a surjection $(UL)^\sharp \rightarrow (UI)^\sharp$ of UI -modules. This induces a linear map

$$f : \text{Tor}_q^{UI}(N, (UL)^\sharp) \longrightarrow \text{Tor}_q^{UL}(N, (UI)^\sharp) ,$$

and (34.8) shows that f is surjective.

Right multiplication in UL/I makes $\text{Hom}(UL/I, -)$ into a left (and thus right) UL/I -module. Define a morphism

$$F : \text{Tor}_q^{UI}(N, (UL)^\sharp) \longrightarrow \text{Hom}(UL/I, \text{Tor}_q^{UI}(N, (UI)^\sharp))$$

of UL/I -modules by setting $F(\alpha)(a) = f(\alpha \cdot a)$, $a \in \text{Tor}_q^{UI}(N, (UL)^\sharp)$, $a \in UL/I$. Recall that an inclusion

$$\Phi : \text{Tor}_q^{UI}(N, (UI)^\sharp) \otimes (UL/I)^\sharp \longrightarrow \text{Hom}(UL/I, \text{Tor}_q^{UI}(N, (UI)^\sharp))$$

of UL/I -modules is given by $\Phi(\alpha \otimes g)(a) = \langle g, a \rangle \alpha$. the image of Φ consists of the linear maps $\varphi : UL/I \rightarrow \text{Tor}_q^{UI}(N, (UI)^\sharp)$ such that for some $n(\varphi)$, φ

vanishes on $(UL/I)_{\geq n(\varphi)}$. Thus Lemma 34.10 implies that $\text{Im } F \subset \text{Im } \Phi$ and we may regard F as a UL/I -linear map into $\text{Tor}_q^{UI}(N, (UI)^\#) \otimes (UL/I)^\#$.

Finally, identify $(UL/I)^\# = W^\#$ and use (34.8) to write F as a map

$$F : \text{Tor}_q^{UI}(N, (UI)^\#) \otimes W^\# \longrightarrow \text{Tor}_q^{UI}(N, (UI)^\#) \otimes W^\# .$$

This F may not be the identity, but a straightforward calculation shows that $(F - id) : - \otimes W_{-n}^\# \longrightarrow - \otimes W_{> -n}^\#, n \geq 0$. Thus F is an isomorphism. \square

Exercise

Suppose I is an ideal in a graded Lie algebra $L = L_{\geq 1}$ and that each L_i is finite dimensional. Prove that:

- (a) If $\text{Ext}_{UI}^j(\mathbb{k}, UI) = 0, j < q$, then $\text{Ext}_{UL}^j(\mathbb{k}, UL) = 0, j < q$.
- (b) If in addition $\text{Ext}_{UI}^j(\mathbb{k}, UI)$ is finite dimensional for $q \leq j \leq p + q + 1$ and if $\text{Ext}_{UL/I}^i(\mathbb{k}, UL/I) = 0$ for $i < p$ then

$$\text{Ext}_{UL}^k(\mathbb{k}, UL) \cong \begin{cases} 0 & , k < p + q \\ \text{Ext}_{UL}^p(\mathbb{k}, UL/I) \otimes \text{Ext}_{UI}^q(\mathbb{k}, UI) & , k = p + q . \end{cases}$$

35 Grade and depth for fibres and loop spaces

In this section (unless otherwise specified) the ground ring \mathbb{k} is an arbitrary principal ideal domain.

Recall from §20 the functors $\text{Ext}_A^k(-, -)$ defined for right modules over a graded algebra A , and the definition of projective dimension of an A -module.

Definition 1. The *grade*, $\text{grade}_A(M)$, of a right A -module is the least integer k such that $\text{Ext}_A^k(M, A) \neq 0$. (If $\text{Ext}_A^*(M, A) = 0$ we say $\text{grade}_A(M) = \infty$.)

The *projective grade*, $\text{proj grade}_A(M)$, is the least integer k (or ∞) such that $\text{Ext}_A^k(M, P) \neq 0$ for some A -projective module P .

2. If $A = \{A_i\}_{i \geq 0}$ and $A_0 = \mathbb{k}$ then the *depth* of A , $\text{depth } A$, is the grade of the trivial A -module \mathbb{k} . The *global dimension* of A , $\text{gl dim } A$ is the greatest integer k (or ∞) such that $\text{Ext}_A^k(\mathbb{k}, -) \neq 0$.

The main theorem of this section provides a connection between LS category and the homological notion of grade. Recall from §2(c) that if

$$f : X \longrightarrow Y$$

is a continuous map then a holonomy action of the loop space ΩY is determined in the homotopy fibre F of f . This makes $H_*(F)$ into a right $H_*(\Omega Y)$ -module. We shall prove:

- *If X is normal and (Y, y_0) is well based, and if $H_*(F)$ and $H_*(\Omega Y)$ are \mathbb{k} -free then*

$$\text{proj grade}_{H_*(\Omega Y)} H_*(F) \leq \text{cat } f .$$

Moreover, if equality holds then

$$\text{proj grade}_{H_*(\Omega Y)} H_*(F) = \text{cat } f = \text{proj dim}_{H_*(\Omega Y)} H_*(F) .$$

When each $H_i(F)$ and $H_j(\Omega F)$ have finite \mathbb{k} bases we will replace proj grade by grade in this theorem.

The special case that $f = \text{id} : X \longrightarrow X$ is sufficiently important that we restate the theorem for it:

- *If X is path connected, well based and normal and if $H_*(\Omega X)$ is \mathbb{k} -free with a finite basis in each degree then*

$$\text{depth } H_*(\Omega X) \leq \text{cat } X .$$

If equality holds then $\text{depth } H_(\Omega X) = \text{cat } X = \text{gl dim } H_*(\Omega X)$.*

The depth theorem for topological spaces was originally deduced, for the case that $\mathbb{k} = \mathbb{Q}$ and $H_*(X)$ has finite type, from a theorem on Sullivan algebras established in a joint paper with Jacobsson and Löfwall [54]. Subsequently it was extended for spaces to $\mathbb{k} = \mathbb{F}_p$ (with $H_*(X)$ still of finite type) in a joint

paper with Lemaire [85] using a different but similar approach. However the theorem for Sullivan models in [54] is for a coefficient field of any characteristic, and is applied as such to the Ext-algebra of a local commutative ring.

The proof given here (for the more general grade theorem) is different in form, although based on the same underlying idea. We shall, however, also sketch the proof of the Sullivan algebra theorem in characteristic zero, since it provides an interesting application of the material in §29:

- *If L is the homotopy Lie algebra of a minimal Sullivan algebra $(\Lambda V, d)$ and if $V = \{V^i\}_{i \geq 2}$ is a graded vector space of finite type then*

$$\text{depth } UL \leq \text{cat}(\Lambda V, d) \leq \text{gl dim } UL .$$

Moreover, if $\text{depth } UL = \text{cat}(\Lambda V, d)$ then $\text{cat}(\Lambda V, d) = \text{gl dim } UL$.

Note: When $(\Lambda V, d)$ is the Sullivan model of a simply connected space X , then $UL \cong H_*(\Omega X)$ and $\text{cat}_0 X = \text{cat}(\Lambda V, d)$, (Theorem 21.5, Proposition 29.4) and so the two results coincide.

This section is organized into the following topics:

- (a) Complexes of finite length.
- (b) ΩY -spaces and $C_*(\Omega Y)$ -modules.
- (c) The Milnor resolution of k .
- (d) The grade theorem for a homotopy fibre.
- (e) The depth of $H_*(\Omega X)$.
- (f) The depth of UL .
- (g) The depth theorem for Sullivan algebras.

Both the grade theorem and the Sullivan algebra theorem have their roots in an elementary theorem about $H(\text{Hom}_A(P_*, Q_*))$, where A is a graded algebra, P_* is an A -projective resolution of an A -module M and Q_* is a complex of free A -modules of finite length. Topics (b)–(e) are then devoted to the grade theorem, which is proved in a topological setting with no reference to Sullivan algebras or graded Lie algebras. This material can be read with only Part I, Part III and §27 as background. Topics (f) and (g) deal with the Sullivan algebra result.

(a) Complexes of finite length.

Let A be a graded algebra (over k). As in §34 we denote by $P_* = \{P_i\}$ a chain complex of A -modules $P_i = P_{i,*}$ of the form

$$0 \longleftarrow P_{0,*} \xleftarrow{d} P_{1,*} \longleftarrow \dots$$

in which $(P_{i,*})_j = P_{i,j-i}$. If Q_* is a second such chain complex then $\text{Hom}_A(P_*, Q_*)$ will denote the bigraded complex of k -modules given by

$$\text{Hom}_A(P_*, Q_*)_{i,*} = \prod_j \text{Hom}_A(P_j, Q_{j+i}) ,$$

with $df = d \circ f - (-1)^{\deg f} f \circ d$.

Key to the proof of the grade theorem is

Lemma 35.1 *Suppose $P_* \xrightarrow{\sim} M$ is an A -projective resolution of an A -module M and suppose $Q_* = \{Q_i\}_{0 \leq i \leq m}$ is a complex of free A -modules. Then*

$$H_{i,*}(\text{Hom}_A(P_*, Q_*)) = 0 , \quad i > m - \text{proj grade}_A M .$$

proof: Set $Q'_* = \{Q_i\}_{0 \leq i \leq m-1}$. Because the P_i are A -projective the sequence

$$0 \longrightarrow \text{Hom}_A(P_*, Q'_*) \longrightarrow \text{Hom}_A(P_*, Q_*) \longrightarrow \text{Hom}_A(P_*, Q_m) \longrightarrow 0$$

is exact. Since Q_m is A -free, $H_{i,*}(\text{Hom}_A(P_*, Q_m)) = \text{Ext}_A^{m-i}(M, Q_m) = 0$, $i > m - \text{proj grade}_A M$. By induction on m , $H_{i,*}(\text{Hom}_A(P_*, Q'_*)) = 0$, $i > m - \text{proj grade}_A M$. The lemma follows. \square

Suppose next that an A -free module N has an A -basis x_α with only finitely many elements in each (ordinary) degree and that A and N are concentrated in degrees ≥ 0 . It is then immediate that

$$\text{Hom}_A(-, N) = \prod_\alpha x_\alpha \cdot \text{Hom}_A(-, A) ,$$

whence

$$\text{Ext}_A(-, N) = \prod_\alpha x_\alpha \cdot \text{Ext}_A(-, A) .$$

Thus we have

Lemma 35.2 *Suppose in the situation of Lemma 35.1 that A and Q_i are concentrated in nonnegative degrees, and that each Q_i has an A -basis with finitely many elements in each degree. Then*

$$H_{i,*}(\text{Hom}_A(P_*, Q_*)) = 0 , \quad i > m - \text{grade}_A M .$$

(b) ΩY -spaces and $C_*(\Omega Y)$ -modules.

Let (Y, y_0) be a based path connected topological space. Multiplication in the loop space ΩY makes it into a topological monoid (§2(b)). A topological space X equipped with a right ΩY -action will be called an ΩY -space and a map

of ΩY -spaces is a continuous map that preserves the action. If X and Z are ΩY -spaces then ΩY acts diagonally on $X \times Z$ via $(x, z) \cdot \gamma = (x \cdot \gamma, z \cdot \gamma)$.

Next recall (§8(a)) that multiplication in ΩY makes $C_*(\Omega Y)$ into a chain algebra via the Eilenberg-Zilber equivalence,

$$C_*(\Omega Y) \otimes C_*(\Omega Y) \xrightarrow{EZ} C_*(\Omega Y \times \Omega Y) \xrightarrow{C_*(\text{mult})} C_*(\Omega Y) .$$

In the same way, if X is any ΩY -space then the action defines a $C_*(\Omega Y)$ -module structure in $C_*(X)$. For example, the constant map $\Omega Y \rightarrow pt$ defines a chain algebra morphism $C_*(\Omega Y) \rightarrow \mathbb{k}$, and makes \mathbb{k} into a $C_*(\Omega Y)$ -module, because $C_*(pt) = \mathbb{k}$ — cf. (4.2).

Now consider the Alexander-Whitney comultiplication

$$\Delta : C_*(\Omega Y) \rightarrow C_*(\Omega Y) \otimes C_*(\Omega Y)$$

introduced in §4(b). It follows directly from the compatibility (4.9) of the Eilenberg-Zilber and Alexander-Whitney equivalences that Δ is a morphism of chain algebras, and so it makes $C_*(\Omega Y)$ into a differential graded Hopf algebra (as also described in §26(b)). In particular, if (M, d) and (N, d) are any two $C_*(\Omega Y)$ -modules then $(M, d) \otimes (N, d)$ is a $C_*(\Omega Y) \otimes C_*(\Omega Y)$ -module in the obvious way, and this action composed with Δ makes $(M, d) \otimes (N, d)$ into a $C_*(\Omega Y)$ -module. We call this the *diagonal action* of $C_*(\Omega Y)$.

Now suppose X and Z are ΩY -spaces, and let ΩY act diagonally on $X \times Z$. A simple calculation with formula (4.9) gives

Lemma 35.3 *The Alexander-Whitney equivalence*

$$AW : C_*(X \times Z) \xrightarrow{\cong} C_*(X) \otimes C_*(Z)$$

is a quasi-morphism of $C_*(\Omega Y)$ -modules, with respect to the topological and algebraic diagonal actions. □

Next, we pass to homology. For any complexes (M, d) and (N, d) a natural map

$$H(M, d) \otimes H(N, d) \rightarrow H((M, d) \otimes (N, d))$$

is defined by sending $[z] \otimes [w] \mapsto [z \otimes w]$ for any cycles z and w in M and N . Moreover, if M and $H(M)$ are \mathbb{k} -free (or if N and $H(N)$ are \mathbb{k} -free) then this is an isomorphism. Indeed, because $d(M) \subset M$ and \mathbb{k} is a principal ideal domain, $\text{Im } d$ is \mathbb{k} -free. Split the short exact sequences

$$0 \rightarrow \ker d \rightarrow M \rightarrow d(M) \rightarrow 0 \quad \text{and} \quad 0 \rightarrow \text{Im } d \rightarrow \ker d \rightarrow H(M) \rightarrow 0$$

to write $(M, d) \cong (H(M), 0) \oplus \bigoplus_{\alpha} (\mathbb{k}m_{\alpha}, \mathbb{k}dm_{\alpha})$. Since $H(M)$ is \mathbb{k} -free we obtain $H((M, d) \otimes (N, d)) = H(H(M) \otimes (N, d)) = H(M) \otimes H(N)$.

In particular the map

$$H_*(\Omega Y) \otimes H_*(\Omega Y) \rightarrow H(C_*(\Omega Y) \otimes C_*(\Omega Y)) \xrightarrow{H(\text{mult})} H_*(\Omega Y)$$

makes $H_*(\Omega Y)$ into a graded algebra and, if X is an ΩY -space, then the map

$$H_*(X) \otimes H_*(\Omega Y) \rightarrow H(C_*(X) \otimes C_*(\Omega Y)) \rightarrow H_*(X)$$

makes $H_*(X)$ into a right $H_*(\Omega Y)$ -module.

Now suppose $H_*(\Omega Y)$ is k -free. Then we may use $H_*(\Omega Y) \otimes H_*(\Omega Y) = H(C_*(\Omega Y) \otimes C_*(\Omega Y))$ to identify $H_*(\Delta)$ as a morphism

$$H_*(\Delta) : H_*(\Omega Y) \rightarrow H_*(\Omega Y) \otimes H_*(\Omega Y)$$

of graded algebras; in other words, $H_*(\Omega Y)$ is a graded Hopf algebra. Thus if X and Z are ΩY -spaces then $H_*(\Omega Y)$ acts diagonally on $H_*(X) \otimes H_*(Z)$ and, moreover, the morphism $H_*(X) \otimes H_*(Z) \rightarrow H(C_*(X) \otimes C_*(Z))$ is a morphism of $H_*(\Omega Y)$ -modules. In particular if $H_*(X)$ is k -free then this provides isomorphisms

$$H_*(X) \otimes H_*(Z) \xrightarrow{\cong} H(C_*(X) \otimes C_*(Z)) \xleftarrow[H(AW)]{\cong} H_*(X \times Z)$$

of $H_*(\Omega Y)$ -modules.

(c) The Milnor resolution of k .

Let (Y, y_0) be a well based path connected topological space. For topological groups G , Milnor [125] constructed the universal bundle $EG \rightarrow BG$ by putting $EG = G^{*\infty}$, the infinite join of G with itself (§2(e)). Here we consider the topological monoid ΩY and, when $H_*(\Omega Y)$ is k free, we use the filtration of $(\Omega Y)^{*\infty}$ by the subspaces $(\Omega Y)^{*n}$ to construct an Eilenberg-Moore resolution of the $C_*(\Omega Y)$ -module, k (§20(d)), which we call the *Milnor resolution*.

Recall from §1(f) that the join $X * Z$ of topological spaces is the space $(X \times CZ) \cup (CX \times Z)$. If X and Z are ΩY spaces then ΩY acts diagonally on $X * Z$ in the obvious way and the inclusion $X \rightarrow X \times \{0\}$ in $X * Z$ is a map of ΩY spaces. In particular, starting with the action of ΩY on itself by right multiplication we obtain a diagonal action in each of the joins $(\Omega Y)^{*n} = (\Omega Y)^{*(n-1)} * \Omega Y$. The inclusions

$$\Omega Y \rightarrow (\Omega Y)^{*2} \rightarrow \dots \rightarrow (\Omega Y)^{*n} \rightarrow$$

are maps of ΩY -spaces and, as in §2(e), we set $(\Omega Y)^{*\infty} = \bigcup_n (\Omega Y)^{*n}$ with the weak topology determined by the $(\Omega Y)^{*n}$.

Lemma 35.4 *Let $A \subset X$ be an inclusion of ΩY -spaces and give $(X, A) \times \Omega Y$ the diagonal action, where ΩY acts by right multiplication on ΩY . If $H_*(X, A)$ is k -free then $H_*((X, A) \times \Omega Y)$ is $H_*(\Omega Y)$ -free.*

proof: If $\gamma \in \Omega Y$ is a loop of length ℓ let γ' be the loop of length ℓ given by $\gamma'(t) = \gamma(\ell - t)$, $0 \leq t \leq \ell$. Then $\gamma \mapsto \gamma\gamma'$ and $\gamma \mapsto \gamma'\gamma$ are homotopically constant maps. Thus the map

$$f : X \times \Omega Y \rightarrow X \times \Omega Y, \quad f(x, \gamma) = (x \cdot \gamma, \gamma)$$

is a homotopy equivalence with homotopy inverse $(x, \gamma) \mapsto (x \cdot \gamma', \gamma)$.

Denote by $(X \otimes \Omega Y)_\Delta$ and $(X \times \Omega Y)_R$ the ΩY -spaces in which ΩY acts respectively diagonally and by right multiplication on ΩY . The isomorphism (cf. §35(b)) $H_*(X, A) \otimes H_*(\Omega Y) \cong H_*((X, A) \times \Omega Y)_R$ identifies this latter as the free $H_*(\Omega Y)$ -module with basis a k -basis of $H_*(X, A)$. On the other hand, $f : (X \times \Omega Y)_R \rightarrow (X \times \Omega Y)_\Delta$ is a map of ΩY -spaces and $H_*(f)$ is therefore an isomorphism of $H_*(\Omega Y)$ -modules. \square

Lemma 35.5

(i) $(\Omega Y)^{* \infty}$ has the weak homotopy type of a point.

(ii) If $H_*(\Omega Y)$ is k -free so is each $H_*((\Omega Y)^{*n})$.

proof: (i) This is an easy exercise since ΩY is well-based (Step 1 of Proposition 27.9) and so $(\Omega Y)^{*(n+1)} \simeq \Sigma(\Omega Y^{*n} \wedge \Omega Y)$ of §1(f), and $(\Omega Y)^{*(n+1)} \simeq \Sigma^{n-1}(\Omega Y)^{\wedge(n+1)}$.

(ii) When X and Z have k -free homology the isomorphism $H_*(X) \otimes H_*(Z) \xrightarrow{\cong} H(C_*(X) \otimes C_*(Z)) \xrightarrow{\cong} H_*(X \times Z)$ identifies $H_*(X \wedge Z)$ as k -free. Now use the formula $(\Omega Y)^{*n} \simeq \Sigma^{n-1}(\Omega Y)^{\wedge n}$. \square

Henceforth we assume $H_*(\Omega Y)$ is k -free. We are ready to construct the Milnor resolution. Define k -free graded modules $V(n)$, $n \geq 0$ by setting

$$V(0) = V_0(0) = k \quad \text{and} \quad V(n) = H_*(C(\Omega Y)^{*n}, (\Omega Y)^{*n}), \quad n \geq 1.$$

Set $V = \bigoplus_n V(n)$. The Milnor resolution will have the form $(V \otimes C_*(\Omega Y), d)$ with $d : V(n) \rightarrow V(< n) \otimes C_*(\Omega Y)$ and $C_*(\Omega Y)$ acting by multiplication from the right. We construct it by simultaneously constructing the differential d and a commutative diagram

$$\begin{array}{ccccccc} V(0) \otimes C_*(\Omega Y) & \longrightarrow & \cdots & \longrightarrow & V(\leq n) \otimes C_*(\Omega Y) & \longrightarrow & \cdots \\ \downarrow \simeq \varphi(0) & & & & \downarrow \simeq \varphi(n) & & \\ C_*(\Omega Y) & \longrightarrow & \cdots & \longrightarrow & C_*(\Omega Y)^{*(n+1)} & \longrightarrow & \cdots \end{array}$$

in which the vertical arrows are quasi-isomorphisms of $C_*(\Omega Y)$ -modules.

Indeed, set $\varphi(0) = id$ and then suppose by induction that $\varphi(n - 1)$ and the differential in $V(< n) \otimes C_*(\Omega Y)$ are constructed. Use excision and Lemma 35.3 to identify

$H_*((\Omega Y)^{*(n+1)}, (\Omega Y)^{*n}) = H((C(\Omega Y)^{*n}, (\Omega Y)^{*n}) \times \Omega Y)$ as the free $H_*(\Omega Y)$ -module $V(n) \otimes H_*(\Omega Y)$.

Next, let v_α be a basis of $V(n)$ and choose elements $z_\alpha \in C_*((\Omega Y)^{*(n+1)})$ such that

- z_α maps to a cycle in $C_*((\Omega Y)^{*(n+1)}, (\Omega Y)^{*n})$ representing v_α ,

and

- $dz_\alpha = \varphi(n-1)u_\alpha$ for some cycle $u_\alpha \in V(< n) \otimes C_*(\Omega Y)$.

Extend the differential to $V(\leq n) \otimes C_*(\Omega Y)$ by setting $dv_\alpha = u_\alpha$ and extend $\varphi(n-1)$ to $\varphi(n)$ by setting $\varphi(n)v_\alpha = z_\alpha$. Then $\varphi(n)$ induces a quotient chain map $\bar{\varphi}(n) : V(n) \otimes C_*(\Omega Y) \rightarrow C_*((\Omega Y)^{*(n+1)}, (\Omega Y)^{*n})$, and $H(\bar{\varphi}(n))$ is the identity, by construction. By the five lemma 3.1, $\varphi(n)$ is a quasi-isomorphism.

Thus the morphisms $\varphi(n)$ define a quasi-isomorphism $\varphi : (V \otimes C_*(\Omega Y), d) \xrightarrow{\cong} C_*((\Omega Y)^{*∞})$, while the constant map $(\Omega Y)^{*∞} \rightarrow pt$ is a map of ΩY -spaces and a weak homotopy equivalence (Lemma 35.5). Composing yields a quasi-isomorphism of $C_*(\Omega Y)$ -modules

$$(V \otimes C_*(\Omega Y), d) \xrightarrow{\cong} \mathbb{k}, \tag{35.6}$$

which we call the *Milnor resolution of \mathbb{k}* .

Filter this semifree resolution by the submodules $(V(\leq n) \otimes C_*(\Omega Y), d)$ to obtain a spectral sequence whose E_1 -term has the form

$$0 \leftarrow \mathbb{k} \leftarrow H_*(\Omega Y) \leftarrow \dots \leftarrow V(n) \otimes H_*(\Omega Y) \leftarrow \dots \tag{35.7}$$

Proposition 35.8 *The sequence (35.7) is an $H_*(\Omega Y)$ -free resolution of \mathbb{k} ; i.e., the Milnor resolution is an Eilenberg-Moore resolution (§20(d)).*

proof: We need only show (35.7) is exact. Filter $C_*((\Omega Y)^{*∞})$ by the submodules $C_*((\Omega Y)^{*n})$. Then the quasi-isomorphism $\varphi : V \otimes C_*(\Omega Y) \rightarrow C_*((\Omega Y)^{*∞})$ preserves filtrations. In the construction of φ we showed that each $H(\bar{\varphi}(n))$ was an isomorphism. This means precisely that φ induces an isomorphism between the E^1 -terms of the spectral sequences. It is thus sufficient to prove that

$$\mathbb{k} \leftarrow H_*(\Omega Y) \xleftarrow{d_1} \dots \xleftarrow{d_1} H_*\left((\Omega Y)^{*(n+1)}, (\Omega Y)^{*n}\right) \xleftarrow{d_1}$$

is exact.

Suppose by induction that

$$0 \leftarrow \mathbb{k} \leftarrow H_*(\Omega Y) \xleftarrow{d_1} \dots \xleftarrow{d_1} H_*\left((\Omega Y)^{*n}, (\Omega Y)^{*(n-1)}\right)$$

is exact. A simple spectral sequence argument then shows that any d_1 -cycle, α , in

$H_*((\Omega Y)^{*n}, (\Omega Y)^{*(n-1)})$ is the image of some class $\beta \in H_*((\Omega Y)^{*n})$. But $(\Omega Y)^{*n}$ is contractible in $(\Omega Y)^{*(n+1)}$. Thus a representing cycle, z , for β has the form $z = dw$ for some $w \in C_*((\Omega Y)^{*(n+1)})$. In particular, w represents a class $\gamma \in H_*((\Omega Y)^{*(n+1)}, (\Omega Y)^{*n})$ and $d_1\gamma = \alpha$. This closes the induction and completes the proof. \square

(d) The grade theorem for a homotopy fibre.

Fix a continuous map

$$f : X \rightarrow Y$$

from a normal topological space X to a path connected, well based topological space (Y, y_0) . Convert f into the fibration $p : X \times_Y MY \rightarrow Y$, whose fibre $F = X \times_Y PY$ is the homotopy fibre of f (§2(c)). The action of ΩY on F then makes $H_*(F)$ into an $H_*(\Omega Y)$ -module (§35(b)).

Theorem 35.9 (Grade theorem) *With the hypotheses and notation above suppose $H_*(F)$ and $H_*(\Omega Y)$ are k -free. Then*

(i) $\text{proj grade}_{H_*(\Omega Y)} H_*(F) \leq \text{cat } f$.

(ii) *If equality holds in (i) then*

$$\text{proj grade}_{H_*(\Omega Y)} H_*(F) = \text{cat } f = \text{proj dim}_{H_*(\Omega Y)} H_*(F) .$$

proof: Since $\text{proj grade} \leq \text{proj dim}$ by definition, both assertions are vacuous unless $\text{cat } f$ is finite. Set $\text{cat } f = m$. The proof of the theorem is in five steps.

Step 1: We construct a map

$$h_F : F \rightarrow (\Omega Y)^{*(m+1)}$$

of ΩY -spaces, where ΩY acts diagonally on $(\Omega Y)^{(m+1)}$ as described in §35(b).*

For this recall the construction in §27(c) of the Ganea fibrations $p_m : P_m Y \rightarrow Y$, with fibre F_m at y_0 . According to Proposition 27.8 (with the roles of X and Y reversed) there is a continuous map $\sigma_0 : X \rightarrow P_m Y$ such that $p_m \sigma_0 = f$. Moreover, by construction $P_m Y$ is obtained by converting $P_{m-1} Y \cup C F_{m-1} \rightarrow Y$ into a fibration and so there is a homotopy σ_t from σ_0 to a map $\sigma_1 : X \rightarrow P_{m-1} Y \cup C F_{m-1}$. Define a continuous map

$$\theta : X \times_Y MY \rightarrow P_m Y = (P_{m-1} Y \cup C F_{m-1}) \times_Y MY$$

as follows: if $(x, w) \in X \times_Y MY$ and w is a path of length ℓ then $\theta(x, w) = (\sigma_1 x, w')$, where w' is the path of length $\ell + 1$ given by $w'(t) = p_m \sigma_{1-t}(x)$, $0 \leq t \leq 1$ and $w'(t) = w(t - 1)$, $t \geq 1$. Observe that $p_m \theta = p$, and so θ restricts to a continuous map

$$\theta_F : F \rightarrow F_m .$$

By construction, θ_F is an ΩY -map.

On the other hand, Proposition 27.6(ii) provides a map $F_m \rightarrow F_{m-1} * \Omega Y$ which is a map of ΩY -spaces and a homotopy equivalence. Iteration of this construction produces an ΩY -map $F_m \rightarrow (\Omega Y)^{*(m+1)}$, because $F_0 = \Omega Y$. Composition with θ_F produces the desired $h_F : F \rightarrow (\Omega Y)^{*(m+1)}$.

Step 2: We construct an algebraic model for the continuous map

$$h = (id, h_F) : F \rightarrow F \times (\Omega Y)^{*(m+1)} .$$

Choose an Eilenberg-Moore resolution (Proposition 20.11), $\alpha : (R, d) \xrightarrow{\cong} C_*(F)$, for the $C_*(\Omega Y)$ -module $C_*(F)$ described in §35(b). Then recall the Milnor resolution $\varphi : (V \otimes C_*(\Omega Y), d) \xrightarrow{\cong} C_*((\Omega Y)^{*\infty})$ of §35(c) and denote the obvious inclusions by $\lambda_m : (V(\leq m) \otimes C_*(\Omega Y), d) \rightarrow (V \otimes C_*(\Omega Y), d)$. The algebraic model of h we wish to construct will be a morphism

$$\psi : (R, d) \rightarrow C_*(F) \otimes (V(\leq m) \otimes C_*(\Omega Y), d)$$

of $C_*(\Omega Y)$ -modules, where $C_*(\Omega Y)$ acts diagonally on the target, and it will satisfy:

$$(\lambda_m \otimes id)\psi : (R, d) \rightarrow C_*(F) \otimes (V \otimes C_*(\Omega Y), d) \text{ is a quasi-isomorphism.}$$

In fact, since (R, d) is semifree we may lift morphisms from (R, d) (up to homotopy) through quasi-isomorphisms (Proposition 6.4(ii)). Apply this remark to the diagram

$$\begin{array}{ccccccc}
 & & & & C_*(F) \otimes (V(\leq m) \otimes C_*(\Omega Y), d) & & \\
 & & & & \nearrow & & \\
 & & & \psi & & & \downarrow \simeq id \otimes \varphi(m) \\
 (R, d) & \xrightarrow{\alpha} & C_*(F) & \xrightarrow{C_*(h)} & C_*(F \times (\Omega Y)^{*(m+1)}) & \xrightarrow{AW} & C_*(F) \otimes C_*(\Omega Y)^{*(m+1)}
 \end{array}$$

to construct ψ . (Note that AW is a morphism of $C_*(\Omega Y)$ -modules by Lemma 35.3. To show $(id \otimes \lambda_m)\psi$ is a quasi-isomorphism, let $j_m : (\Omega Y)^{*(m+1)} \rightarrow (\Omega Y)^{*\infty}$ be the inclusion. Then

$$(id \times j_m)h = (id, j_m h_F) : F \rightarrow F \times (\Omega Y)^{*\infty}$$

is a weak homotopy equivalence, because $(\Omega Y)^{*\infty} \rightarrow pt$ is (Lemma 35.5(i)). But $(id \times \lambda_m)\psi$ is connected (up to homotopy) to the quasi-isomorphism $C_*((id \times j_m)h)$ by quasi-isomorphisms, and hence is one itself.

Step 3: The associated $H_*(\Omega Y)$ -free resolutions of $H_*(F)$.

In the Eilenberg-Moore resolution $(R, d) \xrightarrow{\simeq} C_*(F)$ write $R = W \otimes C_*(\Omega Y)$ where: W is the direct sum $W = \bigoplus_{p=0}^{\infty} W(p)$ of \mathbb{k} -free modules, $d : W(p) \rightarrow W(< p) \otimes C_*(\Omega Y)$ and the filtration $\{W(\leq p) \otimes C_*(\Omega Y)\}$ is the Eilenberg-Moore filtration of R . This defines a homology spectral sequence (E^i, d^i) whose E^1 -term by definition gives an $H(\Omega Y)$ -free resolution of $H_*(F)$ of the form

$$H_*(F) \leftarrow W(0) \otimes H_*(\Omega Y) \xleftarrow{d^1} W(1) \otimes H_*(\Omega Y) \xleftarrow{d^1} \dots$$

We denote this resolution by

$$P_* \xrightarrow{\simeq} H_*(F)$$

with (as in §35(a)) $P_p = W(p) \otimes H_*(\Omega Y)$.

Next, filter $C_*(F) \otimes (V \otimes C_*(\Omega Y), d)$ by the submodules $C_*(F) \otimes V(\leq p) \otimes C_*(\Omega Y)$. This produces a second homology spectral sequence whose E^1 -term gives a complex of $H_*(\Omega Y)$ -modules of the form,

$$H_*(F) \leftarrow H_*(F) \otimes V(0) \otimes H_*(\Omega Y) \xleftarrow{d^1} H_*(F) \otimes V(1) \otimes H_*(\Omega Y) \xleftarrow{d^1} \dots,$$

since $H_*(F)$ and $H_*(\Omega Y)$ are \mathbb{k} -free (cf. §35(b)). Now $H_*(\Omega Y)$ acts diagonally in $(H_*(F) \otimes V(p)) \otimes H_*(\Omega Y)$ and this is a free $H_*(\Omega Y)$ -module on a \mathbb{k} -basis of $H_*(F) \otimes V(p)$ (§35(b) and Lemma 35.4). Moreover, since the Milnor resolution is an Eilenberg-Moore resolution (Proposition 35.8) it follows that this sequence is exact; i.e. it is also an $H_*(\Omega Y)$ -free resolution of $H_*(F)$. We denote it by

$$Q_* \xrightarrow{\simeq} H_*(F)$$

with $Q_p = H_*(F) \otimes V(p) \otimes H_*(\Omega Y)$.

Step 4: Set $\text{proj grade}_{H_*(\Omega Y)} H_*(F) = r$. Then ψ is homotopic (as a morphism of $C_*(\Omega Y)$ -modules) to a morphism η such that

$$\eta : W(p) \rightarrow C_*(F) \otimes V(\leq p + m - r) \otimes C_*(\Omega Y), \quad p \geq 0.$$

Filter $C_*(F) \otimes V(\leq m) \otimes C_*(\Omega Y)$ by the submodules $C_*(F) \otimes V(\leq p) \otimes C_*(\Omega Y)$ to produce a spectral sequence whose E^1 -term is just $(Q_{\leq m}, d_1)$, and denote all spectral sequences by (E^i, d^i) .

Now write ψ as the infinite sum $\psi = \sum_{-\infty}^k \psi_i$ of the $C_*(\Omega Y)$ -linear maps ψ_i defined by

$$\psi_i : W(p) \rightarrow C_*(F) \otimes V(p + i) \otimes C_*(\Omega Y), \quad p \geq 0.$$

(Necessarily $k \leq m$.) Then $d_0\psi_k = \psi_k d_0$ and $H(\psi_k)$ is an $H_*(\Omega Y)$ -linear map

$$H(\psi_k) : (P_*, d^1) \rightarrow (Q_{\leq m}, d^1)$$

that raises the resolution degree by exactly k . We may now apply Lemma 35.1. It asserts that if $k > m - \text{proj grade}_{H_*(\Omega Y)} H_*(F) (= m - r)$ then $H(\psi_k) = d^1\theta + \theta d^1$ for some $H_*(\Omega Y)$ -linear map $\theta : P_* \rightarrow Q_*$ that raises resolution degree by $k + 1$.

Choose $C_*(\Omega Y)$ -linear maps $\theta' : W(p) \otimes C_*(\Omega Y) \rightarrow C_*(F) \otimes V(p + k + 1) \otimes C_*(\Omega Y)$, $p \geq 0$, so that $\theta'(w \otimes 1)$ is a cycle representing $\theta(w \otimes 1)$. Then $d_0\theta' + \theta'd_0 = 0$ and hence $\psi' = \psi - (d\theta' + \theta'd)$ also raises filtration degree by at most $k : \psi' = \sum_{i \leq k} \psi'_i$.

By construction, $H(\psi'_k) = 0 : P_* \rightarrow Q_{\leq m}$. Choose $C_*(\Omega Y)$ -linear maps $\theta'' : W(p) \otimes C_*(\Omega Y) \rightarrow C_*(F) \otimes V(p + k) \otimes C_*(\Omega Y)$, $p \geq 0$, so that $d_0\theta''(w \otimes 1) = \psi'_k(w \otimes 1)$, $w \in W$. Set $\psi'' = \psi' - (d\theta'' + \theta''d)$. By construction, $d_0\theta'' + \theta''d_0 = \psi'_k$ and so $\psi'' = \sum_{i=-\infty}^{k-1} \psi''_i$, while clearly $\psi'' \sim \psi$.

Remark If the k -modules $H_i(F)$ and $H_j(\Omega Y)$ have finite bases for each i and j then this will also be true of each $[H_*(F) \otimes V(\leq m)]_k$, as follows from the definition of V in §35(c). In this case we may use Lemma 35.2 in the proof of Step 4 to find $\psi \sim \eta$ with

$$\eta : W(p) \rightarrow C_*(F) \otimes V(p + m - q) \otimes C_*(\Omega Y), \quad p \geq 0,$$

where $q = \text{grade}_{H_*(\Omega Y)} H_*(F)$.

Step 5: Completion of the proof of Theorem 35.9.

Suppose $\text{proj grade}_{H_*(\Omega Y)} H_*(F) \geq \text{cat } f$ and, as above, write $m = \text{cat } f$ and $r = \text{proj grade}_{H_*(\Omega Y)} H_*(F)$. Since $r \geq m$ Step 4 provides a filtration preserving morphism of $C_*(\Omega Y)$ -modules,

$$\eta : (W \otimes C_*(\Omega Y), d) \rightarrow C_*(F) \otimes (V(\leq m) \otimes C_*(\Omega Y), d).$$

Thus η induces a morphism $E^i(\eta)$ of spectral sequences which, at the E^1 -level has the form

$$E^1(\eta) : P_* \rightarrow Q_{\leq m}$$

(in the notation of Step 3).

Compose η with the inclusion $id \otimes \lambda_m$ of Step 2 to obtain a filtration preserving morphism

$$\eta' : (W \otimes C_*(\Omega Y), d) \rightarrow (C_*(F) \otimes (V \otimes C_*(\Omega Y), d)),$$

which then yields a morphism $E^i(\eta')$ of spectral sequences. The E^1 -terms of these spectral sequences are respectively the resolutions (P_*, d^1) and (Q_*, d^1) of Step 3; in particular it follows from Step 3 that in both cases $E^2 = E^2_{0,*}$. In

each case $E_{0,*}^2 = H_*(F)$ and so the inclusions $W(0) \otimes C_*(\Omega Y) \rightarrow W \otimes C_*(\Omega Y)$ and $C_*(F) \otimes V(0) \otimes C_*(\Omega Y) \rightarrow C_*(F) \otimes V \otimes C_*(\Omega Y)$ induce isomorphisms $E_{0,*}^2 \xrightarrow{\cong} H(-)$ which identify $E^2(\eta') = E_{0,*}^2(\eta') = H(\eta')$.

But $\eta' = (id \otimes \lambda_m)\eta \sim (id \otimes \lambda_m)\psi$, which is a quasi-isomorphism by Step 2. Hence $E^2(\eta')$ is an isomorphism and

$$E^1(\eta') : (P_*, d^1) \rightarrow (Q_*, d^1)$$

is a quasi-isomorphism of resolutions.

Suppose first that $\text{proj grade}_{H_*(\Omega Y)} H_*(F) > \text{cat } f$. Then Step 4 would allow us to choose η so that $\eta = \sum_{k < 0} \eta_k$. It would follow that $E^1(\eta) = 0$ and so $E^1(\eta') = E^1(id \otimes \lambda_m) \circ E^1(\eta) = 0$ as well. Since $E^1(\eta')$ is a quasi-isomorphism this is absurd; i.e.,

$$\text{proj grade}_{H_*(\Omega Y)} H_*(F) \leq \text{cat } f .$$

Now suppose $\text{proj grade}_{H_*(\Omega Y)} H_*(F) = \text{cat } f$, and let N be any right $H_*(\Omega Y)$ -module. Since $E^1(\eta')$ is a quasi-isomorphism of resolutions, it induces a quasi-isomorphism

$$\text{Hom}_{H_*(\Omega Y)}(P_*, N) \xleftarrow{\cong} \text{Hom}_{H_*(\Omega Y)}(Q_*, N) .$$

It follows that $E^1(\eta)$ induces surjections

$$H^{p,q}(\text{Hom}_{H_*(\Omega Y)}(P_*, N)) \leftarrow H^{p,q}(\text{Hom}_{H_*(\Omega Y)}(Q_{\leq m}, N)) ,$$

where (as in §35(a)) the left degree “ p ” is the resolution degree.

Since $Q_{\leq m}$ is concentrated in resolution degree $\leq m$ and since N is concentrated in resolution degree zero it follows that $H^{p,*}(\text{Hom}_{H_*(\Omega Y)}(P_*, N)) = 0$, $p > m$. But

$H^{p,*}(\text{Hom}_{H_*(\Omega Y)}(P_*, N)) = \text{Ext}^p(H_*(F), N)$, since P_* is an $H_*(\Omega Y)$ -free resolution of $H_*(F)$ (cf. §20(b)). Thus $\text{Ext}_{H_*(\Omega Y)}^{> m}(H_*(F), -) = 0$. Since, by assumption, $\text{proj grade}_{H_*(\Omega Y)} H_*(F) = m$ it follows that $\text{Ext}_{H_*(\Omega Y)}^m(H_*(F), -) \neq 0$. Thus $\text{proj dim}_{H_*(\Omega Y)}(H_*(F)) = m$, as desired. This completes the proof. \square

Corollary: *Assume, in addition to the hypotheses of Theorem 35.9, that the k -modules $H_i(F)$ and $H_j(\Omega Y)$ have finite bases for each i and j . Then*

$$\text{grade}_{H_*(\Omega Y)} H_*(F) \leq \text{cat } f$$

and if equality holds then also $\text{cat } f = \text{proj dim}_{H_*(\Omega Y)} H_*(F)$.

proof: The Remark at the end of Step 4 in the proof of the theorem allows us to replace proj grade by grade in Step 5. \square

(e) The depth of $H_*(\Omega X)$.

Theorem 35.10 *If (X, x_0) is a normal path connected topological space and if each $H_i(\Omega X)$ is \mathbb{k} -free on a finite basis then*

$$\text{depth } H_*(\Omega X) \leq \text{cat } X .$$

If equality holds then also $\text{cat } X = \text{gl dim } H_(\Omega X)$.*

proof: Replace X by a well based space of the same homotopy type by adjoining an interval to X at the base point x_0 . Then apply the Corollary above to Theorem 35.9 to $f = id_X$. \square

Corollary *If \mathbb{k} is a field of characteristic zero and if X is simply connected then $\text{depth } UL_X \leq \text{cat}_0 X$, where L_X is the homotopy Lie algebra.*

proof: Replace X by the rationalization (§9) $X_{\mathbb{Q}}$ and note (Theorem 21.5 and Proposition 28.1) that $UL_X = H_*(\Omega X; \mathbb{k}) = H_*(\Omega X_{\mathbb{Q}}; \mathbb{k})$ and that $\text{cat}_0 X = \text{cat } X_{\mathbb{Q}}$. \square

(f) The depth of UL .

In this topic \mathbb{k} is an arbitrary field of characteristic zero.

Suppose $L = \{L_i\}_{i \geq 1}$ is a graded Lie algebra, with universal enveloping algebra UL . In §22(a) and §22(b) we constructed $C_*(L; UL)$ and established its properties, where L is regarded as a differential graded Lie algebra with zero differential. This gives, in particular, a UL -free resolution of \mathbb{k} of the form

$$\mathbb{k} \leftarrow UL \xleftarrow{d} sL \otimes UL \xleftarrow{d} \cdots \xleftarrow{d} \Lambda^n sL \otimes UL \leftarrow \cdots$$

This resolution, which plays the key role in this and the next topic, will be denoted by

$$P_* \xrightarrow{\cong} \mathbb{k} .$$

By definition (§20(b)), $\text{Ext}_{UL}^p(\mathbb{k}, -) = H^{p,*}(\text{Hom}_{UL}(P_*, -))$.

Proposition 35.11 *Let $L = \{L_i\}_{i \geq 1}$ be a graded Lie algebra with each L_i finite dimensional.*

(i) $\text{gl dim } UL$ is the largest integer n (as ∞) such that $\text{Ext}_{UL}^n(\mathbb{k}, \mathbb{k}) \neq 0$.

(ii) $\text{depth } UL \leq \text{gl dim } UL$.

proof: (i) Clearly $n \leq \text{gl dim } UL$, since $\text{Ext}_{UL}^n(\mathbb{k}, \mathbb{k}) \neq 0$. On the other hand, write $P_* = C_*(L) \otimes UL$. Then

$$\text{Ext}_{UL}(\mathbb{k}, \mathbb{k}) = H(\text{Hom}_{UL}(P_*, \mathbb{k})) = H(C_*(L)^{\sharp}) = H(C_*(L))^{\sharp} ,$$

because \mathbb{k} is a field. It follows that $H(C_*(L))$ is concentrated in homological degrees $\leq n$.

Now choose a graded subspace $E \subset \Lambda^n sL$ so that $E \oplus d(\Lambda^{n+1} sL) = \Lambda^n sL$. Observe that $(\Lambda^{<n} sL \oplus E) \otimes UL$ is automatically a subcomplex of P_* , and that the inclusion defines a morphism of the spectral sequences derived from the filtrations $F^p(-) = (-) \cdot (UL)_{\geq p}$. At the E^0 -term the differentials are just $d \otimes id$ in $C_*(L) \otimes UL$ and so this morphism is a quasi-isomorphism of E^0 -terms. It follows that the inclusion of $(\Lambda^{<n} sL \oplus E) \otimes UL$ in P_* is itself a quasi-isomorphism. This $(\Lambda^{<n} sL \oplus E) \otimes UL$ is a UL -free resolution of \mathbb{k} and so $\text{Ext}_{UL}^{>n}(\mathbb{k}, -) = 0$; i.e., $\text{gl dim } UL \leq n$.

(ii) Let $\text{gl dim } UL = n$. Then $\text{Ext}_{UL}^{n+1}(\mathbb{k}, -) = 0$. Apply $\text{Hom}_{UL}(P_*, -)$ to the short exact sequence $0 \rightarrow (UL)_+ \rightarrow UL \rightarrow \mathbb{k} \rightarrow 0$ and pass to homology to obtain an exact sequence

$$\text{Ext}_{UL}^n(\mathbb{k}, UL) \rightarrow \text{Ext}_{UL}^n(\mathbb{k}, \mathbb{k}) \rightarrow \text{Ext}_{UL}^{n+1}(\mathbb{k}, (UL)_+) .$$

Thus $\text{Ext}_{UL}^n(\mathbb{k}, UL)$ surjects onto $\text{Ext}_{UL}^n(\mathbb{k}, \mathbb{k})$, which is non-zero by (i), and so $\text{depth } UL \leq n$. □

(g) The depth theorem for Sullivan algebras.

As in the previous topic, in this topic \mathbb{k} is an arbitrary field of characteristic zero.

Fix a minimal Sullivan algebra $(\Lambda V, d)$ such that $V = \{V^i\}_{i \geq 2}$ is a graded vector space of finite type, and let L be the homotopy Lie algebra of $(\Lambda V, d)$ as defined in §21(e). Recall that $\text{cat}(\Lambda V, d)$ is defined in the introduction to §29. As in the previous topic the complex $P_* = C_*(L; UL)$ and associated constructions will play a key role.

In particular, let d_1 denote the quadratic part of the differential in $\Lambda V : d_1 : V \rightarrow \Lambda^2 V$ and $d - d_1 : V \rightarrow \Lambda^{\geq 3} V$. From the definition of the Lie bracket in §21(e), and Proposition 23.2, and Example 1 in §23(a) we obtain

$$(\Lambda V, d_1) = C^*(L) = \text{Hom}_{UL}(P_*, \mathbb{k}) ,$$

with $\Lambda^p V = \text{Hom}_{UL}(P_p, \mathbb{k})$. Thus

$$\text{Ext}_{UL}^p(\mathbb{k}, \mathbb{k}) = H^{p,*}(\Lambda V, d_1) ,$$

with the left degree “ p ” corresponding to wordlength in ΛV .

Proposition 35.12 $\text{cat}(\Lambda V, d) \leq \text{gl dim } UL$.

proof: Let $n = \text{gl dim } UL$; according to Proposition 35.11 it is the largest integer such that $\text{Ext}_{UL}^n(\mathbb{k}, \mathbb{k}) \neq 0$. Define an ideal $I \subset \Lambda V$ by setting $I = \Lambda^{>n} V \oplus I^n$, where $I^n \oplus (\ker d_1)^{n,*} = \Lambda^n V$. Then $H(I, d_1) = 0$. Filter I by wordlength and use the associated spectral sequence to deduce that $H(I, d) = 0$. Conclude from Corollary 2 to Proposition 29.2 that $\text{cat}(\Lambda V, d) \leq \text{nil}(\Lambda V/I) \leq n$ because $(\Lambda V, d) \rightarrow (\Lambda V/I, d)$ is a quasi-isomorphism. □

Theorem 35.13 [54] *If L is the homotopy Lie algebra of a minimal Sullivan algebra $(\Lambda V, d)$, and if $V = \{V^i\}_{i \geq 2}$ is a graded vector space of finite type, then*

$$\text{depth } UL \leq \text{cat}(\Lambda V, d) \leq \text{gl dim } UL .$$

Moreover if $\text{depth } UL = \text{cat}(\Lambda V, d)$ then $\text{cat}(\Lambda V, d) = \text{gl dim } UL$.

proof: In view of Propositions 35.11 and 35.12 it is sufficient to prove that

$$\text{depth } UL \geq \text{cat}(\Lambda V, d) \implies \text{cat}(\Lambda V, d) \geq \text{gl dim } UL ,$$

and for this we may suppose $\text{cat}(\Lambda V, d)$ is a finite integer m .

Recall first that in §29(f) the surjection $(\Lambda V, d) \rightarrow (\Lambda V/\Lambda^{>m}V, d)$ is extended to a $(\Lambda V, d)$ -semifree resolution of the form

$$\zeta : (\Lambda V \otimes (M \oplus \mathbb{k}), d) \xrightarrow{\cong} (\Lambda V/\Lambda^{>m}V, d) ,$$

and with the following three properties:

- The differential d_1 in ΛV extends to a differential δ_1 in $\Lambda V \otimes (M \oplus \mathbb{k})$ characterized by

$$- \delta_1 : M \rightarrow (V \otimes M) \oplus \Lambda^{m+1}V, \text{ and } d - \delta_1 : M \rightarrow (\Lambda^{\geq 2}V \otimes M) \oplus \Lambda^{\geq m+2}V.$$

$$- \Lambda V \otimes (M \oplus \mathbb{k}) \text{ is a } (\Lambda V, d_1)\text{-module.}$$

- The surjection $(\Lambda V, d_1) \rightarrow (\Lambda V/\Lambda^{>m}V, d_1)$ extends to a $(\Lambda V, d_1)$ -semifree resolution

$$\xi : (\Lambda V \otimes (M \oplus \mathbb{k}), \delta_1) \xrightarrow{\cong} (\Lambda V/\Lambda^{>m}V, d_1)$$

such that $\xi(M) = 0$.

- Because $\text{cat}(\Lambda V, d) = m$ there is a morphism (retraction)

$$\psi : (\Lambda V \otimes (M \oplus \mathbb{k}), d) \rightarrow (\Lambda V, d)$$

of $(\Lambda V, d)$ -modules such that $\psi(1) = 1$.

Now bigrade ΛV and the tensor product by setting $(\Lambda V)^{p,*} = \Lambda^p V$ and $(\Lambda V \otimes (M \oplus \mathbb{k}))^{p,*} = (\Lambda^{p-m}V \otimes M) \oplus \Lambda^p V$. Then filter by setting $F^p(-) = (-)^{\geq p,*}$. Thus d_1 (or δ_1) increases filtration degree by 1 while $d - d_1$ (or $d - \delta_1$) increases it by at least 2. On the other hand, ψ need not preserve the filtration degree. However ψ can decrease the filtration degree by at most m and so it can

be written as the infinite sum $\psi = \sum_{i=-k}^{\infty} \psi_i$, some $k \leq m$, of the ΛV -linear maps ψ_i characterized by:

- ψ_i increases filtration degree by exactly i .

It is immediate that $d_1\psi_{-k} - \psi_{-k}\delta_1 = 0$. Simplify notation by writing $N = M \oplus \mathbb{k}$. Then ψ_{-k} is a cycle of bidegree $(-k, 0)$ in the bigraded complex $\text{Hom}_{\Lambda V}(\Lambda V \otimes N, \Lambda V)$, (defined with respect to the differentials d_1 and δ_1). We show below that

$$H^{p,*}(\text{Hom}_{\Lambda V}(\Lambda V \otimes N, \Lambda V)) = 0, \quad p < 0. \tag{35.14}$$

This implies that if $k > 0$ then $\psi_{-k} = d_1\theta + \theta\delta_1$ for some ΛV -linear map $\theta: \Lambda V \otimes N \rightarrow \Lambda V$ that decreases filtration degree by exactly $k + 1$. Thus $\psi - (d\theta + \theta d)$ is a retraction which decreases filtration degree by at most $k - 1$.

Proceeding in this way we find a retraction η that preserves filtrations. But then $\eta = \sum_{i=0}^{\infty} \eta_i$ and $\eta_0: (\Lambda V \otimes N, \delta_1) \rightarrow (\Lambda V, d_1)$ satisfies $\eta_0(1) = 1$. This implies that $H(\eta_0)$ is surjective. Since

$$H^{p,*}(\Lambda V \otimes N, \delta_1) \xrightarrow[H(\xi)]{\cong} H^{p,*}(\Lambda V/\Lambda^{>m}V, d_1) = 0, \quad p > m,$$

it follows that $\text{Ext}_{UL}^{>m}(\mathbb{k}, \mathbb{k}) = H^{>m,*}(\Lambda V, d_1) = 0$; i.e., $\text{cat}(\Lambda V, d) = m \geq \text{gl dim } UL$.

It remains to prove (35.14). We shall work entirely in the category of bigraded complexes; in particular, Hom will always mean bigraded Hom and \sharp will mean the bigraded dual: $(C_{*,*}^\sharp)^{p,q} = C_{p,q}^\sharp$.

Now regard each $\Lambda^p sL \otimes UL$ as a left L -module by setting

$$x \cdot a = -(-1)^{\deg x \deg a} a \cdot x, \quad x \in L, a \in \Lambda^p sL \otimes UL.$$

Denote the differential in each $C_*(L; \Lambda^p sL \otimes UL)$ by ∂_1 and denote the maps

$$C_*(L; \Lambda^p sL \otimes UL) \xrightarrow{id \otimes d} C_*(L; \Lambda^{p-1} sL \otimes UL)$$

by ∂_2 . Then $\partial = \partial_1 + \partial_2$ is a differential of bidegree $(-1, 0)$ in the bigraded module $C_*(L) \otimes C_*(L) \otimes UL$, where the bigrading is given by $(-)_p,* = \bigoplus_{i+j=p} C_i \otimes C_j \otimes UL$.

As in §22(b) this complex is in fact a differential graded coalgebra. Moreover, if Δ is the comultiplication in $C_*(L)$ then an easy calculation shows that the composite $C_*(L) \xrightarrow{\Delta} C_*(L) \otimes C_*(L) \hookrightarrow C_*(L) \otimes C_*(L) \otimes UL$ commutes with the differentials and is in fact a dgc quasi-isomorphism.

Dualizing we find that multiplication in $(\Lambda V, d_1)$ extends to a cochain algebra quasi-isomorphism of the form

$$(\Lambda V \otimes \Lambda V \otimes (UL)^\sharp, d_1) \xrightarrow{\cong} (\Lambda V, d_1),$$

where $(\Lambda V)^{p,*} = \Lambda^p V$ and $(\Lambda V \otimes \Lambda V \otimes (UL)^\sharp)^{p,*} = \bigoplus_{i+j=p} \Lambda^i V \otimes \Lambda^j V \otimes (UL)^\sharp$.

This is a quasi-isomorphism of $(\Lambda V, d_1)$ -semifree modules and so we may apply $\Lambda V/\Lambda^{>m}V \otimes_{\Lambda V} -$ to obtain a quasi-isomorphism

$$(\Lambda V \otimes \Lambda V/\Lambda^{>m}V \otimes (UL)^\sharp, d_1) \xrightarrow{\cong} (\Lambda V/\Lambda^{>m}V, d_1).$$

Lift this to a quasi-isomorphism into $(\Lambda V \otimes N, \delta_1)$ and thereby reduce (35.14) to the assertion

$$H^{p,*}(\text{Hom}_{\Lambda V}(\Lambda V \otimes \Lambda V / \Lambda^{>m} V \otimes (UL)^\sharp, \Lambda V)) = 0, \quad p < 0. \quad (35.15)$$

Next observe that $\Lambda V / \Lambda^{>m} V \otimes (UL)^\sharp = (\Lambda^{\leq m} sL \otimes UL)^\sharp$. Thus there are canonical identifications of bigraded vector spaces

$$\begin{aligned} & \text{Hom}_{\Lambda V}(\Lambda V \otimes \Lambda V / \Lambda^{>m} V \otimes (UL)^\sharp, \Lambda V) \\ &= \text{Hom}(\Lambda V / \Lambda^{>m} V \otimes (UL)^\sharp, \Lambda V) \\ &= \text{Hom}\left((\Lambda^{\leq m} sL \otimes UL)^\sharp, (\Lambda sL)^\sharp\right) \\ &= \text{Hom}\left(\Lambda sL, (\Lambda^{\leq m} sL \otimes UL)^{\sharp\sharp}\right) \\ &= \text{Hom}(\Lambda sL, \Lambda^{\leq m} sL \otimes UL) \\ &= \text{Hom}_{UL}(\Lambda sL \otimes UL, \Lambda^{\leq m} sL \otimes UL), \end{aligned}$$

where we may identify $(\Lambda^{\leq m} sL \otimes UL)^{\sharp\sharp}$ with $\Lambda^{\leq m} sL \otimes UL$ because this graded vector space has finite type. An arduous but straightforward calculation shows that this defines an isomorphism of complexes

$$\text{Hom}_{\Lambda V}(\Lambda V \otimes \Lambda V / \Lambda^{>m} V \otimes (UL)^\sharp, \Lambda V) \cong \text{Hom}_{UL}(P_*, P_{\leq m}).$$

Since ΛsL is a graded vector space of finite type Lemma 35.2 (applied with $A = UL$ and $M = \mathbb{k}$) gives

$$H^{p,*}(\text{Hom}_{UL}(P_*, P_{\leq m})) = 0, \quad p < \text{depth } UL - m.$$

Since $\text{depth } UL$ is supposed $\geq m$ this proves (35.15) and the theorem. □

Exercises

1. Let X be a simply connected CW complex of finite type. Prove that $\text{depth } H_*(\Omega(S^3 \vee X); \mathbb{Q}) = 1$.
2. Let X be a simply connected finite CW complex. Prove that $\text{depth } H_*(\Omega X; \mathbb{k}) \leq e_{\mathbb{k}}(X)$ for any field \mathbb{k} .
3. Let X be a simply connected formal space with $H^*(X; \mathbb{Q}) \simeq \mathbb{Q}[a, b] / (a^4, b^4, a^2 b^2)$ and $\text{deg } a = 2, \text{deg } b = 2$. Prove that $\text{cat}_0 X = 4$. Consider the map $f : S^4 \vee S^4 \rightarrow K(\mathbb{Q}^2, 4)$ (resp. $g : K(\mathbb{Q}^2, 2) \rightarrow K(\mathbb{Q}^2, 4)$) corresponding to the fundamental classes of the spheres (resp. to the squares of generators of $H^*(K(\mathbb{Q}^2, 2))$). Convert g into a fibration and show that X has the rational homotopy type of the pullback of g along f .

$$\begin{array}{ccc} X_0 & \xrightarrow{h} & K(\mathbb{Q}^2, 2) \\ \downarrow & & \downarrow g \\ (S^4 \vee S^4)_0 & \xrightarrow{f} & K(\mathbb{Q}^2, 4) \end{array}$$

Compute the rational homotopy Lie algebra of X using the homotopy fibre of h . Prove that the dimension of the centre of L_X is 2, and that the depth of $H_*(\Omega X; \mathbb{Q})$ is 3.

36 Lie algebras of finite depth

In this section the ground ring \mathbb{k} is a field of characteristic $\neq 2, 3$.

Throughout the section we adopt the convention:

- L is a graded Lie algebra such that $L = \{L_i\}_{i \geq 1}$ and each L_i is finite dimensional. (36.1)

Recall from the start of §35 that the depth of the universal enveloping algebra, UL , is the least integer m (or ∞) such that $\text{Ext}_{UL}^m(\mathbb{k}, UL) \neq 0$. Here we shall slightly abuse language with the

Definition The *depth* of L is the depth of its universal enveloping algebra, UL .

In §35 (Corollary to Theorem 35.10) we showed that if X is a simply connected topological space and if each $H_i(\Omega X)$ is finite dimensional then

$$\text{depth } L_X \leq \text{cat}_0 X ,$$

where L_X is the homotopy Lie algebra of X . Thus spaces of finite rational category have homotopy Lie algebras of finite depth.

Here we study graded Lie algebras L of finite depth m and show that

- The sum of all the solvable ideals in L is finite dimensional.
- UL is right noetherian if and only if L is finite dimensional.
- There are at most m linearly elements x_i in L_{even} such that $\text{ad } x_i$ is locally nilpotent.

As just observed these results apply to the homotopy Lie algebra of a space of finite rational category. The reader should also note that the third result is a considerable strengthening of Theorem 31.16.

This section is organized into the following topics:

- (a) Depth and grade.
- (b) Solvable Lie algebras and the radical.
- (c) Noetherian enveloping algebras.
- (d) Locally nilpotent elements.
- (e) Examples.

(a) Depth and grade.

Proposition 36.2

(i) If L is the direct sum of ideals I and J then

$$\text{depth } L = \text{depth } I + \text{depth } J .$$

(ii) If L is the infinite direct sum of non-zero ideals then $\text{depth } L = \infty$.

proof: (i) Because of (36.1) we may identify $\text{Ext}_{UL}^p(\mathbb{k}, UL)$ with $\text{Tor}_p^{UL}(\mathbb{k}, UL^\sharp)^\sharp$, $p \geq 0$ (Lemma 34.3(iii)). Thus $\text{depth } L$ is the least integer m such that $\text{Tor}_m^{UL}(\mathbb{k}, UL^\sharp) \neq 0$. On the other hand, if P_* and Q_* are respectively UI - and UJ -free resolutions of \mathbb{k} then $P_* \otimes Q_*$ is a $UI \otimes UJ$ -free resolution of \mathbb{k} . Since $UL = UI \otimes UJ$ this gives

$$\begin{aligned} \text{Tor}^{UL}(\mathbb{k}, UL^\sharp) &= H((P_* \otimes Q_*) \otimes_{UL} (UI^\sharp \otimes UJ^\sharp)) \\ &= H(P_* \otimes_{UI} UI^\sharp) \otimes H(Q_* \otimes_{UJ} UJ^\sharp) \\ &= \text{Tor}^{UI}(\mathbb{k}, UI^\sharp) \otimes \text{Tor}^{UJ}(\mathbb{k}, UJ^\sharp). \end{aligned}$$

Assertion (i) follows.

(ii) Here there is no $a \in UL$ such that $(UL)_+ \cdot a = 0$ and so $\text{Ext}_{UL}^0(\mathbb{k}, UL) = \text{Hom}_{UL}(\mathbb{k}, UL) = 0$. Thus $\text{depth } L \geq 1$. But then for each $n \geq 1$ we may write L as the direct sum of n ideals $L(i)$, each of which is itself an infinite direct sum. Thus by (i), $\text{depth } L = \sum_{i=1}^n \text{depth } L(i) \geq n$. Hence $\text{depth } L = \infty$. \square

Next, recall from Lemma 34.3(i) that if $I \subset L$ is an ideal then $\text{Tor}^{UI}(\mathbb{k}, \mathbb{k})$ is naturally a right UL/I -module.

Proposition 36.3 *Let $I \subset L$ be an ideal.*

(i) $\text{depth } I \leq \text{depth } L$.

(ii) If $\alpha \cdot UL/I$ is finite dimensional for all $\alpha \in \text{Tor}_q^{UI}(\mathbb{k}, \mathbb{k})$, $q \leq \text{depth } L$, then $\text{depth } L/I \leq \text{depth } L$.

(iii) If the hypothesis of (ii) holds and the Lie algebras L/I is finitely generated then

$$\text{depth } I + \text{depth } L/I = \text{depth } L.$$

proof: (i) The Hochschild-Serre spectral sequence (§34(b)) converges from $E_2^{p,q} = \text{Ext}_{UL/I}^p(\mathbb{k}, \text{Ext}_{UI}^q(\mathbb{k}, UL))$ to $\text{Ext}_{UL}^{p+q}(\mathbb{k}, UL)$. Since UL is UI -free

it follows that $\text{Ext}_{UL}^q(\mathbb{k}, UL) = 0$, $q < \text{depth } I$. Hence $\text{Ext}_{UL}^r(\mathbb{k}, UL) = 0$, $r < \text{depth } I$ and $\text{depth } L \geq \text{depth } I$.

(ii) Let $m = \text{depth } L$. We show first that $\text{Ext}_{UL}^m(\mathbb{k}, UL/I) \neq 0$. In fact, filter UL by the UL -modules $F^p = UL \cdot (UI)_{\geq p}$. Use the duality of $\text{Ext}_{UL}^m(\mathbb{k}, UL)$ and $\text{Tor}_m^{UL}(\mathbb{k}, (UL)^\#)$ to deduce that for $0 \neq \alpha \in \text{Ext}_{UL}^m(\mathbb{k}, UL)$ there is a maximum p such that α is in the image of $\text{Ext}_{UL}^m(\mathbb{k}, F^p)$. It follows that α maps to a non-zero element in $\text{Ext}_{UL}^m(\mathbb{k}, F^p/F^{p+1})$. But F^p/F^{p+1} is just $UL/I \otimes (UI)_p$ as a UL -module, and so $\text{Ext}_{UL}^m(\mathbb{k}, UL/I) \neq 0$.

Next observe that the Remark in §34(b) identifies the E_2 -term in the Hochschild Serre spectral sequence for $\text{Ext}_{UL}^m(\mathbb{k}, UL/I)$ as

$$E_2^{p,q} = \text{Ext}_{UL/I}^p(\text{Tor}_q^{UI}(\mathbb{k}, \mathbb{k}), UL/I) .$$

Thus, for some $p + q = m$, this term is non-zero and so (cf §35)

$$\text{grade}_{UL/I}(\text{Tor}_q^{UI}(\mathbb{k}, \mathbb{k})) \leq p \leq \text{depth } L .$$

It is thus sufficient to prove that

$$\text{depth } L/I \leq \text{grade}_{UL/I}(M)$$

for any non-zero L/I -module M for which $\alpha \cdot UL/I$ is finite dimensional, $\alpha \in M$.

Write M as the increasing union of sub L/I -modules $M(i) \subset M(i+1)$, $i \geq 0$, with L/I acting trivially on each $M(i)/M(i-1)$. As in §20(b) there is a UL/I -free resolution P_* of M such that P_* is the increasing union of free resolutions $P_*(i)$ of $M(i)$, and also $P_*(i)/P_*(i-1)$ is a free resolution of $M(i)/M(i-1)$.

Suppose now that $\text{Ext}_{UL/I}^p(\mathbb{k}, UL/I) = 0$. If $a \in \text{Hom}_{UL/I}(P_p, UL/I)$ is a co-cycle vanishing on $P_p(i-1)$ then the induced cocycle in $\text{Hom}_{UL/I}(P_p(i)/P_p(i-1),$

$UL/I)$ is a coboundary by hypothesis. Thus for some $b \in \text{Hom}_{UL/I}(P_{p-1}, UL/I)$ vanishing on $P_{p-1}(i-1)$ we have: $a - db$ vanishes on $P_p(i)$. This argument shows that a itself is a coboundary and hence that $\text{Ext}_{UL/I}^p(M, UL/I) = 0$. Thus $\text{grade}_{UL/I}(M) \geq \text{depth } L/I$, as desired.

(iii) Recall that the Hochschild-Serre spectral sequence (§34(b)) converges from $\text{Ext}_{UL/I}^p(\mathbb{k}, \text{Ext}_{UI}^q(\mathbb{k}, UL))$ to $\text{Ext}_{UL}^{p+q}(\mathbb{k}, UL)$. The duality observations in §34(b) identify the E_2 -term with the dual of $\text{Tor}_p^{UL/I}(\mathbb{k}, \text{Tor}_q^{UI}(\mathbb{k}, (UL)^\#))$ and this coincidences with $\text{Tor}_p^{UL/I}(\mathbb{k}, (UL/I)^\#) \otimes \text{Tor}_q^{UI}(\mathbb{k}, (UI)^\#)$, by Proposition 34.11, provided that $q \leq \text{depth } L$.

Since some $E_2^{p,q} \neq 0$ for $p + q = \text{depth } L$ we may conclude that $\text{depth } L \geq \text{depth } L/I + \text{depth } I$. Suppose inequality held and put $r = \text{depth } L/I$ and $s = \text{depth } I$. Then $E_2^{r,s} \neq 0$ and $E_2^{r+j, s-j+1} = 0 = E_2^{r-j, s+j-1}$. This would imply $E_\infty^{r,s} \neq 0$ contradicting $\text{depth } L > r + s$. □

(b) Solvable Lie algebras and the radical.

A graded Lie algebra L is called *solvable* if some $L^{(n+1)} = 0$, where $L^{(n)}$ is the ideal defined inductively by

$$L^{(0)} = L \quad \text{and} \quad L^{(n+1)} = [L^{(n)}, L^{(n)}] \quad , \quad n \geq 0 .$$

The *solvlength* of L is the largest n such that $L^{(n)} \neq 0$. Recall that we restrict attention to those L satisfying $L = \{L_i\}_{i \geq 1}$ and with each L_i finite dimensional.

Theorem 36.4 *The graded Lie algebra L is solvable and of finite depth if and only if L is finite dimensional. In this case $\text{Ext}_{UL}^*(\mathbb{k}, UL)$ is one dimensional, and*

$$\text{depth } L = \dim L_{\text{even}} .$$

proof: Suppose L is solvable and has finite depth. The ideal $[L, L]$ has finite depth (Proposition 36.3(i)), and so by induction on solvlength, $[L, L]$ is finite dimensional. In particular, for some k , $L_{\geq k}$ is an abelian ideal, also of finite depth. Write $L_{\geq k} = \bigoplus_{\alpha} \mathbb{k}x_{\alpha}$ and note that each $\mathbb{k}x_{\alpha}$ is an ideal in $L_{\geq k}$. Since $L_{\geq k}$ has finite depth it cannot be an infinite direct sum. (Proposition 36.2(ii)) and hence $L_{\geq k}$ is finite dimensional. Thus so is L .

Conversely, suppose L is finite dimensional. Since $L = L_{\geq 1}$, L is trivially solvable. Moreover, a non-zero element x in L of maximal degree is central. Set $\mathbb{k}x = I$ and put

$$e = \begin{cases} 1 & \text{if } \deg x \text{ is even} \\ 0 & \text{if } \deg x \text{ is odd.} \end{cases}$$

Since UI is either the exterior or polynomial algebra on $\mathbb{k}x$, a simple direct calculation gives

$$\text{Ext}_{UI}^{\neq e}(\mathbb{k}, UI) = 0 \quad \text{and} \quad \dim \text{Ext}_{UI}^e(\mathbb{k}, UI) = 1 .$$

Thus Proposition 34.7 asserts that there are isomorphisms of UL/I -modules,

$$\text{Ext}_{UI}^q(\mathbb{k}, UL) \cong \begin{cases} UL/I & \text{if } q = e \\ 0 & \text{otherwise.} \end{cases}$$

In particular the Hochschild-Serre spectral sequence collapses at E_2 , and

$$\text{Ext}_{UL}^r(\mathbb{k}, UL) \cong \text{Ext}_{UL/I}^{r-e}(\mathbb{k}, UL/I) .$$

It follows by induction on $\dim L$ that $\text{Ext}_{UL}^*(\mathbb{k}, UL)$ is one dimensional and that $\text{depth } L = \dim L_{\text{even}}$. □

Definition The *radical* of a graded Lie algebra L is the sum of all the solvable ideals of L .

Theorem 36.5 [54] *If L satisfying (36.1) has finite depth then its radical, R , is finite dimensional and $\dim R_{\text{even}} \leq \text{depth } L$.*

proof: Every solvable ideal $I \subset L$ satisfies $\dim I_{\text{even}} \leq \text{depth } L$, by Theorem 36.4. Choose I so that $\dim I_{\text{even}}$ is maximized. For any solvable ideal J , $I + J$ is solvable, and hence $J_{\text{even}} \subset I_{\text{even}}$. It follows that $R_{\text{even}} = I_{\text{even}}$ and so, for some k , $R_{\geq k}$ is concentrated in odd degrees. Thus $R_{\geq k}$ is abelian and R itself is solvable.

Now Theorem 36.4 asserts that $\text{Ext}_{UR}^*(\mathbb{k}, UR)$ is one-dimensional and concentrated in $* = \dim R_{\text{even}}$. It follows that the isomorphism $\text{Ext}_{UR}^*(\mathbb{k}, UL) \cong \text{Ext}_{UR}^*(\mathbb{k}, UR) \otimes UL/R$ identifies the left hand side with UL/R as a L/R -module. Thus the E_2 -term of the Hochschild-Serre spectral sequence converging from $\text{Ext}_{UL/R}^p(\mathbb{k}, \text{Ext}_{UR}^q(\mathbb{k}, UL))$ to $\text{Ext}_{UL}^{p+q}(\mathbb{k}, UL)$ is given by

$$E_2^{p,q} = \begin{cases} \text{Ext}_{UL/R}^p(\mathbb{k}, UL/R) & , q = \dim R \\ 0 & , \text{otherwise.} \end{cases}$$

In particular, the spectral sequence collapses at E_2 , and $\text{depth } L = \text{depth } L/R + \dim R_{\text{even}}$. □

(c) Noetherian enveloping algebras.

A graded algebra A is *right noetherian* if any right A -submodule of A is finitely generated. In this case any submodule of a finitely generated right module is finitely generated.

Theorem 36.6 *Suppose L is a graded Lie algebra satisfying (36.1). If L has finite depth then*

$$UL \text{ is right noetherian} \iff \dim L \text{ is finite.}$$

Remark This Theorem was originally proved for homotopy Lie algebras of spaces of finite category by Bogvard and Halperin [28].

proof: Suppose UL is right noetherian. Then any submodule of a finitely generated right UL -module is finitely generated. In particular \mathbb{k} admits a UL -free resolution P_* such that each P_p is UL -free on a finite basis, and this implies that each $\text{Tor}_{UL}^q(\mathbb{k}, \mathbb{k})$ is finite dimensional.

Next, note that any sub Lie algebra $E \subset L$ is also right noetherian. Indeed (Corollary to Proposition 21.2) multiplication in UL defines an isomorphism $UE \otimes V \xrightarrow{\cong} UL$ for some subspace $V \subset UL$. If $M \subset UE$ is any subspace then $M \cdot UL = M \cdot UE \otimes V$. It follows that a minimal set of generators for the UE module $M \cdot UE$ is also a minimal set of generators for $M \cdot UL$ as a UL -module. In particular this is finite and so any right UE -submodule of UE is finitely generated; i.e., UE is right noetherian.

Consider the ideal $I = L_{\geq n}$, some $n > 0$. Since I is right noetherian each $\text{Tor}_q^{UI}(\mathbb{k}, \mathbb{k})$ is finite dimensional and hence Proposition 36.3(ii) asserts that $\text{depth } L \geq \text{depth } L/I$. Since L/I is finite dimensional Theorem 36.5 asserts that $\dim(L/I)_{\text{even}} \leq \text{depth } L$. This holds for $I = L_{\geq n}$, any n , and so L_{even} is finite dimensional and, for large n , $L_{\geq n}$ is concentrated in odd degrees. Then $L_{>n}$ is abelian and L is solvable, hence finite dimensional (Theorem 36.5).

Conversely, if $\dim L$ is finite write $L = I \oplus \mathbb{k}x$ where I is an ideal and x is a non-zero element of minimal degree. By induction on $\dim L$ we may suppose UI to be right noetherian. Use multiplication in UL to define an isomorphism $UI \otimes \Lambda x \xrightarrow{\cong} UL$.

If $\deg x$ is odd then $UI \otimes \Lambda x$ is generated as a UI -module by 1 and x and any sub UL -module is finitely generated even as a UI -module. Suppose $\deg x$ is even. If $M \subset UL$ is a right UL -submodule define subspaces $S(k) \subset UI$ as follows: $a \in S(k)$ if and only if $ax^k + \sum_{i < k} a_i x^i \in M$ for some elements $a_i \in UI$. Then $S(k)$ is a right UI -submodule. Since $S(k) \subset S(k+1) \subset \dots$ it follows that for some n , $S(n) = \bigcup_k S(k)$, and we can find a finite subset of $\bigcup_k S(k)$ which contains a set of generators for each $S(k)$, $k \leq n$. As in the classical case of polynomial algebras it is straightforward to use these to construct a finite set of generators for M as a UL -module. Thus UL is right noetherian. \square

(d) Locally nilpotent elements.

An element $x \in L$ is *locally nilpotent* or an *Engel element* (cf. introduction to §31) if for all $y \in L$ there is an $n(y)$ for which $(\text{ad } x)^{n(y)}y = 0$.

Theorem 36.8 *A graded Lie algebra L satisfying (36.1) and of depth m contains at most m linearly independent Engel elements of even degree.*

proof: We show that if $L = I \oplus \mathbb{k}x$, with I an ideal and x a non-zero Engel element of even degree, then $\text{depth } I < \text{depth } L$. (The theorem follows from this by an obvious argument.)

To establish this assertion note first that since $\text{ad } x$ is locally nilpotent, x acts locally nilpotently in each $\text{Tor}_q^{UI}(\mathbb{k}, \mathbb{k})$, as follows directly from Example 2, §34(a). Thus Proposition 36.3(iii) asserts that

$$\text{depth } I + \text{depth } \mathbb{k}x = \text{depth } L$$

and the conclusion follows from $\text{depth } \mathbb{k}x = 1$ (because x has even degree). \square

(e) Examples.

Recall that graded Lie algebras L satisfy $L = L_{\geq 1}$ and each L_i is finite dimensional.

Example 1 Depth = 0.

A graded Lie algebra L has depth 0 if and only if $\text{Hom}_{UL}(\mathbb{k}, UL) \neq 0$; i.e., if and only if $a \cdot UL_+ = 0$ for some non-zero $a \in UL$. It follows at once from the Poincaré Birkoff Witt theorem 21.1 that this occurs if and only if L is finite dimensional and concentrated in odd degrees. \square

Example 2 Free products have depth 1.

Let E and L be graded Lie algebras and recall the free product $E \amalg L$ defined in §21(c). We shall show that $\text{depth } E \amalg L = 1$.

Indeed, choose free resolutions of the form

$$\begin{aligned} \xrightarrow{d} V(2) \otimes UE &\xrightarrow{d} V(1) \otimes UE \xrightarrow{d} UE \rightarrow \mathbb{k}, \text{ and} \\ \xrightarrow{d} W(2) \otimes UE &\xrightarrow{d} W(1) \otimes UL \xrightarrow{d} UL \rightarrow \mathbb{k}. \end{aligned}$$

Then as described in §21(c) there is a $U(E \amalg L)$ -free resolution of \mathbb{k} of the form

$$[V(2) \oplus W(2)] \otimes U(E \amalg L) \xrightarrow{d} [V(1) \oplus W(1)] \otimes U(E \amalg L) \xrightarrow{d} U(E \amalg L) \rightarrow \mathbb{k}$$

in which the restriction of d to $V(i)$ and $W(i)$ is given by the resolutions above.

Choose non-zero elements $x \in E$ and $y \in L$ and define a $U(E \amalg L)$ -linear map $f : [V(1) \oplus W(1)] \otimes U(E \amalg L) \rightarrow U(E \amalg L)$ by $f(v) = (dv) \cdot yx$ and $f(w) = (dw) \cdot xy$. Trivial calculations show that $f \circ d = 0$ and that f is not a coboundary. \square

Example 3 $X \vee Y$.

Let X and Y be simply connected spaces with rational homotopy of finite type. In Example 2 of §24(f) we observed that $L_{X \vee Y} = L_X \amalg L_Y$. Thus $\text{depth } L_{X \vee Y} = 1$.

On the other hand, $\text{cat}_0(X \vee Y) = \max(\text{cat}_0 X, \text{cat}_0 Y)$ as follows from the remarks at the start of §27. Thus the difference cat_0 -depth can be arbitrarily large. \square

Example 4 Products.

If E and L are graded Lie algebras then

$$\text{depth}(E \oplus L) = \text{depth } E + \text{depth } L$$

as observed in Proposition 36.2. Since $L_{X \times Y} = L_X \oplus L_Y$ we have that $\text{depth } L_{X \times Y} = \text{depth } L_X + \text{depth } L_Y$ in analogy with $\text{cat}_0(X \times Y) = \text{cat}_0 X + \text{cat}_0 Y$ (Theorem 30.2) \square

Example 5 $X = S_a^3 \vee S_b^3 \cup_{[a[a,b]_w]} D^8$.

This CW complex was first discussed in Example 2, §13(d) and subsequently in Example 4, §24(f) and in Example 3, §33(c). In §33(c) we showed that the homotopy fibre of the retraction $X \rightarrow S_a^3$ was rationally $S_b^3 \vee S^5$, and that the fibre inclusion $\varphi : S_b^3 \vee S^5 \rightarrow X$ restricted to S^5 represented $[a, b]_w$.

Recall that L_X is the rational homotopy Lie algebra of X . If $\alpha, \beta \in (L_X)_2$ correspond to $a, b \in \pi_3(X)$ then it follows easily that $L_X = \mathbb{L}(\alpha, \beta)/[\alpha, [\alpha, \beta]]$. As an immediate consequence we see that α is an Engel element in L_X .

Write $L_X = \mathbb{k}\alpha \oplus I$, where $I = \mathbb{k}\beta \oplus (L_X)_{\geq 4}$. The argument proving Theorem 36.8 shows that $\text{depth } I < \text{depth } L$. Since also $\text{depth } I > 0$ (Example 1, above) we have $\text{depth } L_X \geq 2$. On the other hand, X is a 2-cone and so $\text{cat } X \leq 2$ (Theorem 27.10). Since $\text{depth } L_X \leq \text{cat}_0 X$ (Theorem 35.10) we conclude

$$\text{depth } L_X = \text{cat}_0 X = \text{cat } X = 2 . \quad \square$$

Example 6 $\mathbb{C}P^\infty / \mathbb{C}P^n$.

Because the inclusion $i : \mathbb{C}P^n \rightarrow \mathbb{C}P^\infty$ induces the surjection $\Lambda x \rightarrow \Lambda x/x^{n+1}$ in cohomology ($\deg x = 2$), the cohomology algebra of $\mathbb{C}P^\infty / \mathbb{C}P^n$ is just $\mathbb{Q} \oplus x^{n+1} \cdot \Lambda x$. Moreover, $\mathbb{C}P^\infty / \mathbb{C}P^n$ is $2n+1$ connected and so $\pi_{2n+2}(\mathbb{C}P^\infty / \mathbb{C}P^n) = H_{2n+2}(\mathbb{C}P^\infty / \mathbb{C}P^n) = \mathbb{Z}$. This defines a continuous map $f : \mathbb{C}P^\infty / \mathbb{C}P^n \rightarrow K(\mathbb{Z}, 2n+2)$. Let $g : F \rightarrow \mathbb{C}P^\infty / \mathbb{C}P^n$ be the homotopy fibre.

Next, observe that a Sullivan representative for i is also a Sullivan representative for the surjection $\Lambda x \rightarrow \Lambda x/x^{n+1}$, ($\deg x = 2$). Use Lemma 13.3 and 13.4 to deduce that $A = \mathbb{k} \oplus x^{n+1} \Lambda x$ is a commutative model for $\mathbb{C}P^\infty / \mathbb{C}P^n$.

Extend the inclusion $\Lambda x^{n+1} \rightarrow A$ to a minimal Sullivan model $\varphi : (\Lambda x^{n+1} \otimes \Lambda V, d) \xrightarrow{\cong} (A, 0)$. This is a Sullivan model for $\mathbb{C}P^\infty / \mathbb{C}P^n$ and the inclusion of Λx^{n+1} is a Sullivan representative for f . Thus the quotient Sullivan algebra $(\Lambda V, \bar{d})$ is a minimal Sullivan model for F . Moreover since A is Λx^{n+1} -free on the basis $1, x^{n+2}, \dots, x^{2n+1}$ it follows that φ induces a quasi-isomorphism

$$\bar{\varphi} : (\Lambda V, \bar{d}) \xrightarrow{\cong} \mathbb{k} \oplus \bigoplus_{i=n+2}^{2n+1} \mathbb{k}x^i .$$

Thus F is a formal space in which cup-products vanish and hence F has the rational homotopy type of $\bigvee_{i=n+2}^{2n+1} S^{2i}$ (Theorem 24.5).

Let L be the rational homotopy Lie algebra of $\mathbb{C}P^\infty / \mathbb{C}P^n$. The discussion above establishes the short exact sequence

$$0 \rightarrow \mathbb{L}(\alpha_1, \dots, \alpha_n) \rightarrow L \rightarrow \mathbb{Q}\beta \rightarrow 0$$

with $\deg \beta = 2n+1$ and $\deg \alpha_i = 2n+2i+1$. Now Proposition 36.3(iii) asserts that

$$\text{depth } L = \text{depth } \mathbb{Q}\beta + \text{depth } \mathbb{L}(\alpha_1, \dots, \alpha_n) = 1 . \quad \square$$

Example 7 $e_0(X) = 2; \text{cat}_0(X) = \text{depth } L_X = 3$.

Consider the commutative rational cochain algebra $(A, d) = (\Lambda(a, b, \{x_n\}_{n \geq 1}) / I, d)$ with $\deg a = \deg b = 2, \deg x_n = 3n-1, I$ the ideal generated by a^2, b^2 and $\Lambda^{\geq 2}(\{x_n\}_{n \geq 1})$, and $dx_1 = 0$ and $dx_{n+1} = abx_n$. This is a commutative model for

some rational topological space X (§17). The inclusion $\Lambda(a, b)/a^2, b^2 \rightarrow (A, d)$ defines a fibration $X_{\mathbb{Q}} \rightarrow S_{\mathbb{Q}}^2 \times S_{\mathbb{Q}}^2$ whose homotopy fibre is the infinite wedge $F = \bigvee_{n \geq 1} S_{\mathbb{Q}}^{3n-1}$ (same argument as in Example 6).

Consider the inclusion $S_{\mathbb{Q}}^2 \vee S_{\mathbb{Q}}^2 \rightarrow S_{\mathbb{Q}}^2 \times S_{\mathbb{Q}}^2$ and pull this fibration back to a fibration $Y \rightarrow S_{\mathbb{Q}}^2 \vee S_{\mathbb{Q}}^2$. A commutative model for Y is just $\Lambda(a, b)/\Lambda^{\geq 2} a, b \otimes_{\Lambda(a, b)/a^2, b^2} A$ (same argument again), and this is just the tensor product $H(S_{\mathbb{Q}}^2 \vee S_{\mathbb{Q}}^2) \otimes H(F)$. It follows that $Y \simeq_{\mathbb{Q}} (S_{\mathbb{Q}}^2 \times S_{\mathbb{Q}}^2) \times F$. Since $S_{\mathbb{Q}}^2 \vee S_{\mathbb{Q}}^2 \rightarrow S_{\mathbb{Q}}^2 \times S_{\mathbb{Q}}^2$ is surjective in homotopy this implies that L_X is the direct sum of the ideals L_F and $L_{S_{\mathbb{Q}}^2 \times S_{\mathbb{Q}}^2}$.

Now Proposition 36.2(i) asserts that

$$\text{depth } L_X = \text{depth } L_F + \text{depth } L_{S_{\mathbb{Q}}^2} + \text{depth } L_{S_{\mathbb{Q}}^2} = 3 .$$

On the other hand, X has a commutative model with product length 3 and so Theorem 29.1 states that $\text{cat } X \leq \text{cl } X \leq 3$. Since $\text{depth } X \leq \text{cat } X$ we have $\text{depth } X$

$= \text{cat } X = \text{cl } X = 3$. Finally, if $(\Lambda V, d)$ is a minimal Sullivan model for X then any cocycle of wordlength ≥ 3 in ΛV will map to such a cocycle in A , and these are all coboundaries. It follows that $e(X) \leq 2$. If $e(X) = 1$ then $\text{cat } X = 1$ (Theorem 28.5(ii)). Thus $e(X) = 2$. □

Example 8 $L = \text{Der}_{>0} \mathbb{L}_V$, where V is a finite dimensional vector space of dimension at least 3.

Write $V = kv \oplus W$ where $v \in V_{\text{even}}$ unless $V_{\text{even}} = 0$. Then there are infinitely many linearly independent elements x in $\mathbb{L}(W)_{\text{even}}$ and each one determines $\theta_x \in \text{Der } \mathbb{L}_V$ by $\theta_x(v) = x$ and $\theta_x(W) = 0$. It is straightforward to verify that each θ_x is an Engel element in L , and so $\text{depth } L = \infty$. □

Exercises

1. Let X be a 1-connected finite CW complex and let Y be an r -connected hyperbolic space such that $\dim X + 1 < r$. Prove that the space of continuous maps $\text{Map}(X, Y)$, endowed with the compact-open topology, is a 1-connected space. Prove that the evaluation map, $\text{Map}(X, Y) \rightarrow X, f \mapsto f(x_0)$, is a fibration which admits a section. We denote by $\text{Map}_*(X, Y)$ the fibre of this fibration. Prove that $\text{depth } \text{Map}_*(X, Y) = \text{depth } \text{Map}(X, Y) = \infty$, so that $\text{cat } \text{Map}(X, Y) = \infty$.

2. Prove that the radical of the graded Lie algebra $L = \mathbb{L}(a, b)/[a[a, b]]$, with $\text{deg } a = 2 = \text{deg } b$ is trivial.

3. Let $f : \prod_{i=1}^N S^3 \rightarrow S^{3N}$ be the natural pinch map. Convert the projection $S^3 \vee S^{3N} \rightarrow S^{3N}$ into a fibration $E \rightarrow S^{3N}$ and consider the pull back fibration $X \rightarrow \prod_{i=1}^N S^3$ along f . Compute the radical of $\pi_*(\Omega X) \otimes \mathbb{Q}$.

37 Cell Attachments

In this section the ground ring is \mathbb{Q} except that in the first topic it is any commutative ring.

Consider a cellular map

$$f : S^n \rightarrow X$$

between simply connected CW complexes (recall from Theorem 1.2 that any continuous map is homotopic to a cellular map). The first objective of this section is to study the relationship between the rational homotopy Lie algebra of X and of the CW complex $Y = X \cup_f D^{n+1}$ obtained by attaching an $(n+1)$ -cell to X along f . We shall assume f is not a rational homotopy equivalence, so that Y is not a rational point.

Convert the inclusion $i : X \rightarrow Y$ into the fibration $q : X \times_Y MY \rightarrow Y$, as defined in §2(c). The fibre of P , $F = X \times_Y PY$ is the *homotopy fibre* of i , and the *holonomy action* of ΩY on F is simply right multiplication in PY . The inclusion of $X \times_Y PY$ in $X \times_Y MY$ is homotopic to the projection $p : X \times_Y PY \rightarrow X$, which is an ΩY -fibration — the *holonomy fibration* for q . Note that because f is null homotopic in Y it lifts to a map $g : S^n \rightarrow X \times_Y PY$. Thus we have the commutative diagram

$$\begin{array}{ccc} & X \times_Y PY = F & \\ & \nearrow g & \downarrow p \\ S^n & \xrightarrow{f} & X \\ & & \downarrow i \\ & & Y = X \cup_f D^{n+1}. \end{array}$$

Let $[S^n]$ denote the fundamental class in $H_n(S^n)$ (any coefficients). Our first step is to prove

- $H_+(F)$ is the free $H_*(\Omega Y)$ -module on the element $H_n(g)[S^n]$.

We use this to give several equivalent conditions for $\pi_*(i) \otimes \mathbb{Q}$ to be surjective, in which case there is an explicit formula connecting the Hilbert series for $UL_X = H_*(\Omega X; \mathbb{Q})$ and $UL_Y = H_*(\Omega Y; \mathbb{Q})$.

Next we consider the case where X is a wedge of spheres and we attach a family of cells: $Y = \left(\bigvee_{\alpha} S^{\alpha} \right) \cup_f \left(\bigsqcup_i D^{n_i+1} \right)$, via a map $f = \{f_i : S^{n_i} \rightarrow X\}$. For these spherical 2-cones we derive the explicit formula for the Hilbert series of UL_Y originally established by Anick [6].

In [140] Serre posed the question: If Y is a simply connected finite CW complex is the Hilbert series of UL_Y rational? The original negative answer was given by Anick [6]. Here we construct an example due to Löfwall and Roos.

It is a finite spherical 2-cone with the additional property that L_Y contains an infinite dimensional abelian Lie algebra (although it cannot contain an infinite dimensional abelian ideal by Theorem 36.5).

This section is organized into the following topics:

- (a) The homology of the homotopy fibre, $X \times_Y PY$.
- (b) Whitehead products and G -fibrations.
- (c) Inert elements.
- (d) The homotopy Lie algebra of a spherical 2-cone.
- (e) Presentations of graded Lie algebras.
- (f) The Löfwall-Roos example.

(a) The homology of the homotopy fibre, $X \times_Y PY$.

The path space fibration $PY \rightarrow Y$ restricts to the holonomy fibration $X \times_Y PY \rightarrow X$. In Proposition 8.4 we constructed a cellular model for $C_*(X \times_Y PY)$ of the form

$$(C \otimes C_*(\Omega Y), d) \xrightarrow{\cong} C_*(X \times_Y PY),$$

where each C_k was free on the k -cells of X . A slight modification of the construction extends this to a cellular model of the form

$$((C \oplus ke_{n+1}) \otimes C_*(\Omega Y), d) \xrightarrow{\cong} C_*(PY).$$

This induces a quasi-isomorphism

$$ke_{n+1} \otimes (C_*(\Omega Y), d) \xrightarrow{\cong} C_*(PY, X \times_Y PY)$$

of $C_*(\Omega Y)$ -modules. The connecting homomorphism is an isomorphism of degree -1 of $H_*(\Omega Y)$ -modules from $H_*(PY, X \times_Y PY)$ to $H_+(X \times_Y PY)$ and it follows that $H_+(X \times_Y PY)$ is the free $H_*(\Omega Y)$ -module on a single class of degree n . Moreover, it is immediate from the construction that this class is $H_*(g)[S^n]$. This establishes

Proposition 37.1 $H_+(X \times_Y PY)$ is the free $H_*(\Omega Y)$ -module on the single basis element $H_*(g)[S^n]$. □

(b) Whitehead products and G -fibrations.

Let $p: E \rightarrow B$ be a G -fibration with fibre G at the basepoint $* \in B$, where G is any topological monoid. Given continuous maps $a: (S^{n+1}, *) \rightarrow (B, *)$ and $b: (S^m, *) \rightarrow (E, *)$ we construct a continuous map

$$c: (S^{n+m}, *) \rightarrow (E, *)$$

as follows. Lift a to $\hat{a} : (D^{n+1}, S^n, *) \rightarrow (E, G, *)$ and regard b as a map $(D^m, S^{m-1}) \rightarrow (E, *)$. Then set

$$c(x, y) = \begin{cases} b(x) \cdot \hat{a}(y) & , (x, y) \in D^m \times S^n \\ \hat{a}(y) & , (x, y) \in S^{m-1} \times D^{n+1}. \end{cases}$$

Now a, b, c represent classes $\alpha \in \pi_{n+1}(B)$, $\beta \in \pi_m(E)$ and $\gamma \in \pi_{n+m}(E)$, and the restriction $\partial a : S^n \rightarrow G$ of \hat{a} represents the image $\partial_*\alpha$ of α under the connecting homomorphism $\partial_* : \pi_*(B) \rightarrow \pi_{*-1}(G)$. Finally, recall that the action of G on E determines an action of $H_*(G)$ on $H_*(F)$ (§8).

Proposition 37.2 ([S-T]) *With the notation above,*

$$\pi_*(p)\gamma = [\pi_*(p)\beta, \alpha]_W \quad \text{and} \quad \text{hur } \gamma = \text{hur } \beta \cdot \text{hur } \partial_*\alpha .$$

proof: The first assertion is immediate from the definition of the Whitehead product (§13(e)). For the second, observe that c factors over the surjection $\partial(D^m \times D^{n+1}) \rightarrow (S^m \times S^n) \cup D^{m+1}$ to define $\hat{c} : (S^m \times S^n) \cup D^{m+1} \rightarrow E$. Moreover, $\text{hur } \gamma = H_*(c) [\partial(D^m \times D^{n+1})] = H_*(\hat{c}) ([S^m] \otimes [S^n]) = \text{hur } \beta \cdot \text{hur } \alpha$, where $[\]$ denotes fundamental class. \square

(c) Inert elements.

We maintain the notation established at the start of this section. Recall also that $L_Z = \pi_*(\Omega Z) \otimes \mathbb{Q}$ denotes the homotopy Lie algebra of a simply connected space Z , and that the connecting homomorphism of the path space fibration is an isomorphism $\pi_{*+1}(Z) \otimes \mathbb{Q} \xrightarrow{\cong} L_Z$.

In particular, let $\xi \in (L_F)_{n-1}$ and $\omega \in (L_X)_{n-1}$ correspond to $[g]$ and to $[f]$. Then $\pi_*(\Omega p)\xi = \omega$ and so $\pi_*(\Omega i)\omega = 0$.

Theorem 37.3 *The following conditions on $[f]$ are equivalent:*

- (i) F has the rational homotopy type of a wedge of at least two spheres.
- (ii) $\pi_*(\Omega i) : L_X \rightarrow L_Y$ is surjective.
- (iii) $\pi_*(\Omega i)$ is surjective, and its kernel is the Lie ideal I generated by ω .
- (iv) The ideal I generated by ω is a free Lie algebra, and the quotient $I/[I, I]$ is a free UL_X/I module on the single generator, ω .

Remark An element α in a graded Lie algebra L is called *inert* if the Lie ideal I it generates is a free Lie algebra and if also $I/[I, I]$ is a free UL/I module on the single generator α . Thus Theorem 37.2 asserts that $L_X \rightarrow L_Y$ is surjective if and only if ω is inert.

proof of Theorem 37.3: Recall that we use rational coefficients throughout, so that $H_*(-) = H_*(; \mathbb{Q})$. First observe that (i) \Leftrightarrow (ii). Indeed, if (i) holds then L_F is a free Lie algebra on at least two generators (Theorem 24.5) and hence has no central elements. But in §28 (Example 2 combined with Proposition 28.7) we showed that elements in the kernel of $\pi_*(F) \rightarrow \pi_*(X)$ correspond to central elements in L_F . Thus $L_F \rightarrow L_X$ is injective and $L_X \rightarrow L_Y$ is surjective.

Conversely, if $L_X \rightarrow L_Y$ is surjective then it follows from Proposition 37.2 that the subspace $hur[g] \cdot UL_Y$ is in the image of the Hurewicz homomorphism, $hur : \pi_*(F) \otimes \mathbb{Q} \rightarrow H_*(F)$. Since $hur[g] \cdot UL_Y = H_+(F)$ (Proposition 37.1) it follows that $\text{Im } hur = H_+(F)$. Now Theorem 24.5 asserts that F has the rational homotopy type of a wedge of spheres (at least two because Y is non trivial).

Next observe that if (i) and (ii) hold then $\pi_*(\Omega p) : L_F \xrightarrow{\cong} \ker \pi_*(\Omega i)$. Since $I \subset \ker \pi_*(\Omega i)$ (because $\pi_*(\Omega i)\omega = 0$) it is, in this case, a sub Lie algebra of a free Lie algebra. By the Corollary to Proposition 21.4 I itself is a free Lie algebra. This shows that under any of the hypotheses (i)–(iv), I itself is a free Lie algebra.

Factor $\pi_*(\Omega i)$ to define a morphism

$$\varphi : L_X/I \rightarrow L_Y$$

and note that $I \subset \pi_*(\Omega p)L_F (= \ker \pi_*(\Omega i))$. It is immediate from the long exact homotopy sequence that;

$$\varphi \text{ is an isomorphism in degrees } \leq r \iff \pi_*(\Omega p) : (L_F)_{<r} \xrightarrow{\cong} I_{<r} . \quad (37.4)$$

Moreover, since I is a free Lie algebra we may choose a wedge of spheres $S = \bigvee_{\alpha} S^{k_{\alpha}+1}$ such that $L_S = I$, and since $I \subset \text{Im } \pi_*(\Omega p)$ we may construct a continuous map

$$h : \bigvee_{\alpha} S^{k_{\alpha}+1} \rightarrow F$$

such that $\pi_*(\Omega p) \circ \pi_*(\Omega h)$ is the inclusion of I in L_X .

The main step in the proof of the theorem is

Lemma 37.5 *If any of the conditions (i)–(iv) of Theorem 37.2 hold then φ is an isomorphism.*

proof: Suppose φ is an isomorphism in degrees $\leq r$. Then (37.4) shows that $\pi_*(h) : \pi_{\leq r}(S) \otimes \mathbb{Q} \xrightarrow{\cong} \pi_{\leq r}(F) \otimes \mathbb{Q}$. Extend h to $h' : S' = S \vee \bigvee_i S_i^{r+1} \vee \bigvee_j S_j^{r+2}$ so that $\pi_*(h')$ is a rational isomorphism in degrees $< r + 1$ and rationally surjective in degree $r + 2$. Then (proof of Theorem 8.6 or via an easy argument using Theorem 7.5) $H_*(h')$ is an isomorphism in degrees $\leq r + 1$.

Let $\beta \in \pi_{r+1}(F) \otimes \mathbb{Q}$ correspond to $\alpha \in (L_F)_r$. Then $hur \beta = hur[g] \cdot \theta$ for some $\theta \in (UL_Y)_{r+1-n}$. Since φ is an isomorphism in this degree we can write $\theta = \varphi \theta'$ for some $\theta' \in UL_X/I$. Thus Proposition 37.2 asserts that $hur \beta = hur \beta'$

where $\pi_*(p)\beta'$ is a linear combination of iterated Whitehead products starting with $[f]$. However, the correspondence $\pi_*(X) \otimes \mathbb{Q} \cong (L_X)_{*-1}$ converts Whitehead products to Lie brackets (Proposition 16.11). Thus if $\alpha' \in (L_F)_r$ corresponds to β' then $\pi_*(\Omega p)\alpha' \in I$. Moreover, the image of $\pi_*(\Omega p)\alpha'$ in $I/[I, I]$ is just $\omega \cdot \theta'$.

On the other hand, since $\beta - \beta' \in \ker hur$ and since $\pi_{r+1}(h') \otimes \mathbb{Q}$ and $H_{r+1}(h')$ are isomorphisms it follows that $\beta - \beta' = \pi_{r+1}(h')\gamma$, where $\gamma \in \pi_{r+1}(S') \otimes \mathbb{Q}$ is in the kernel of the Hurewicz homomorphism for S' . Hence $\beta - \beta' = \pi_{r+1}(h)\gamma$, where $\gamma \in \pi_{r+1}(S) \otimes \mathbb{Q}$ corresponds to an element $\hat{\gamma} \in [L_S, L_S]$. Thus $\pi_*(\Omega p)(\alpha - \alpha') = \pi_*(\Omega p)\pi_*(\Omega h)\hat{\gamma} \in [I, I]$.

We are ready to show that φ_{r+1} is an isomorphism. Indeed, $\pi_*(\Omega p)\alpha = \pi_*(\Omega p)\alpha' + \pi_*(\Omega p)(\alpha - \alpha') \in I$, as just shown, and so $\pi_*(\Omega p)(L_F)_r = I_r$. On the other hand if (i), (ii) or (iii) hold then $\pi_*(\Omega p) : L_F \rightarrow L_X$ is automatically injective (because (i) \Rightarrow (ii)). Suppose (iv) holds and that $\pi_*(\Omega p)\alpha = 0$. As just shown $\pi_*(\Omega p)(\alpha' - \alpha) \in [I, I]$ and $\pi_*(\Omega p)\alpha'$ represents $\omega \cdot \theta'$ in $I/[I, I]$. Since UL_X/I acts freely on ω in $I/[I, I]$ it follows that $\theta' = 0$ and so $hur\beta = hur[g] \cdot \varphi\theta' = 0$. This implies (as above) that $\beta \in \pi_{r+1}(h)(\pi_{r+1}(S) \otimes \mathbb{Q})$ and hence that $\alpha \in \pi_*(\Omega h)L_S$. Since $\pi_*(\Omega p)$ is injective in this subspace, $\alpha = 0$; i.e. $\pi_*(\Omega p) : (L_F)_{r+1} \rightarrow (L_X)_{r+1}$ is injective. \square

We now return to the proof of Theorem 32.3. The Lemma asserts that if (ii) holds then φ is an isomorphism. This implies at once that (ii) \Rightarrow (iii). Moreover since φ is an isomorphism if (iv) holds then in this case $\pi_*(\Omega p) : L_F \xrightarrow{\cong} I$ and hence $\pi_*(\Omega h) : L_S \rightarrow L_F$ is an isomorphism, and h is a rational homotopy equivalence. Thus (iv) \Rightarrow (i). Finally if (iii) holds then again $h : S \rightarrow F$ is a rational homotopy equivalence. This defines a degree 1 isomorphism $L_S/[L_S, L_S] \xrightarrow{\cong} H_+(F)$. Now $L_S = I$ and it follows from Proposition 37.2 that the action of L_X/I in $I/[I, I]$ corresponds to the action of L_X/I in $H_+(F)$. Since the latter is a free UL_X/I module on a single generator (Proposition 37.1) so is the former. Thus (iii) \Rightarrow (iv). \square

(d) The homotopy Lie algebra of a spherical 2-cone.

Consider a continuous map

$$f : Z = \bigvee_{\beta} S^{m_{\beta}+1} \rightarrow X = \bigvee_{\alpha} S^{n_{\alpha}+1}$$

between two simply connected wedges of spheres with rational homology of finite type; and write $Y = X \cup_f CZ$. Then (Theorem 24.5) Y has a free Lie model of the form $(\mathbb{L}_{V \oplus W}, d)$ in which:

$$sV \cong H_+(X), \quad dV = 0 \quad \text{and} \quad W \cong H_+(Z) \quad \text{and} \quad d : W \rightarrow \mathbb{L}_V .$$

Assign a bigrading to this differential graded Lie algebra by setting $V_p = V_{0,p}$ and $W_q = W_{1,q-1}$. Then d has bidegree $(-1, 0)$. In particular the homotopy Lie algebra $L_Y = H(\mathbb{L}_{V \oplus W}, d)$ inherits a bidegree: $L_Y = \bigoplus_{i=0}^{\infty} (L_Y)_{i,*}$. This exhibits

L_Y as the direct sum

$$L_Y = L \oplus I$$

of the sub Lie algebra $L = (L_Y)_{0,*}$ and the ideal $I = (L_Y)_{+,*}$.

Proposition 37.6 *With the hypotheses above, I is a free graded Lie algebra.*

proof: Denote $\mathbb{L}_{V \oplus W}$ simply by \mathbb{L} . Then $d(\mathbb{L}_{1,*})$ is an ideal in $\mathbb{L}_{0,*}$ and so $E = \mathbb{L}_{+,*} \oplus d(\mathbb{L}_{1,*})$ is an ideal in \mathbb{L} with quotient $\mathbb{L}/E = (L, 0)$.

Now apply the cochain construction of §23 to obtain a relative Sullivan algebra $C^*(L, 0) \rightarrow C^*(\mathbb{L}, d)$ with Sullivan fibre $C^*(E, d)$. Recall that $C^*(\mathbb{L}) = \Lambda(s\mathbb{L})^\sharp$, which we bigrade by setting $(s\mathbb{L}_{p,q})^\sharp = [(s\mathbb{L})^\sharp]^{p+1,q}$. Thus the differential in $C^*(\mathbb{L})$ has bidegree $(1,0)$.

Now let $(E', d) \subset (E, d)$ be the sub Lie algebra given by

$$E'_p = \begin{cases} 0 & \text{if } p = 0 \\ \ker d & \text{if } p = 1 \\ E_p & \text{if } p \geq 2. \end{cases}$$

The inclusion $(E', d) \rightarrow (E, d)$ is a quasi-isomorphism and so (Proposition 22.5) $C^*(E, d) \xrightarrow{\cong} C^*(E', d)$. In particular it follows that:

$$H^+(C^*(E, d)) \text{ is concentrated in bidegrees } (p, q) \text{ with } p \geq 2. \tag{37.7}$$

On the other hand, $H^+(C^*(\mathbb{L}, d)) \cong H((sV \oplus sW)^\sharp, d)$, by Proposition 22.8. Hence $H^+(C^*(\mathbb{L}, d))$ is concentrated in bidegrees (p, q) with $p = 1, 2$. It follows that there is a quasi-isomorphism $C^*(\mathbb{L}, d) \xrightarrow{\cong} (A, d)$ of bigraded commutative cochain algebras in which $A = \mathbb{Q} \oplus A^{1,*} \oplus A^{2,*}$.

Finally, we can extend $C^*(L, 0)$ to the acyclic relative Sullivan algebra $C^*(L, (UL)^\sharp)$ by dualizing the construction of §23(c). Then we have quasi-isomorphisms

$$C^*(E) \xleftarrow{\cong} C^*(\mathbb{L}) \otimes_{C^*(L)} C^*(L, (UL)^\sharp) \rightarrow A \otimes_{C^*(L)} C^*(L, (UL)^\sharp) .$$

Now $A \otimes_{C^*(L)} C^*(L, (UL)^\sharp) = A \otimes (UL)^\sharp$ is concentrated in bidegrees $(p, *)$ with $p \leq 2$, because $(L)^\sharp$ is concentrated in bidegrees $(0, *)$. It follows that $H(C^*(E))$ is concentrated in bidegrees $(p, *)$ with $p \leq 2$. Comparing this with (37.7) we see that $H^+(C^*(E, d))$ is concentrated in bidegrees $(2, *)$.

This implies that there is a quasi-isomorphism $C^*(E, d) \xrightarrow{\cong} (\mathbb{k} \oplus H^{2,*}, 0)$ with multiplication in $H^{2,*}$ trivial. It follows that $I = H(E, d) \cong H(\mathcal{L}C^*(E, d)) \cong \mathbb{L}(s^{-1}H^{2,*})$ is a free graded Lie algebra (use Theorem 22.9). \square

Recall from §3(e) that the Hilbert series for a graded vector space $V_{\geq 0}$ is the formal power series $V(z) = \sum_0^\infty \dim V_n z^n$. Similarly, if $H = H^{\geq 0}$ then $H(z) = \sum_0^\infty \dim H^n z^n$.

Proposition 37.8 (Anick [6]) *With the notation preceding Proposition 37.6,*

$$UL_Y(z)^{-1} = (1 + z)UL(z)^{-1} - (z - H_+(Z)(z) + H_+(X)(z)) .$$

Corollary *If X and Z are finite wedges then $UL_Y(z)$ is rational if and only if $UL(z)$ is rational.*

proof of Proposition 37.8: If $C_0 \leftarrow C_1 \leftarrow \dots \leftarrow C_n$ is a finite dimensional chain complex then $\Sigma(-1)^p \dim H_p(C) = \Sigma(-1)^p \dim C_p$, as follows by a trivial calculation. Hence if $C_{0,*} \leftarrow C_{1,*} \leftarrow \dots \leftarrow C_{n,*}$ is a finite complex of graded vector spaces of finite type with differential of bidegree $(-1, 0)$ then $\Sigma(-1)^p \dim C_{p,q} = \Sigma(-1)^p \dim H_{p,q}$, $q \geq 0$. This implies that

$$\sum_p (-1)^p z^{n-p} C_{p,*}(z) = \sum_p (-1)^p z^{n-p} H_{p,*}(C)(z) .$$

Apply this (in the notation of the proof of Proposition 37.6) to the complex $(A \otimes (UL)^\sharp) = A^\sharp \otimes UL$ to obtain

$$[A^{2,*}(z) - zA^{1,*}(z) + z^2A^{0,*}(z)] UL(z) = [sS(z) + z^2] ,$$

where $I = \mathbb{L}_S$. On the other hand since $C^*(\mathbb{L}, d) \xrightarrow{\cong} (A, d)$ it follows that $H^+(A)$ is the dual of the homology of the complex

$$(sV)^\sharp \rightarrow (sW)^\sharp .$$

Thus

$$\begin{aligned} &A^{2,*}(z) - zA^{1,*}(z) + z^2A^{0,*}(z) \\ &= H^{2,*}(A)(z) - zH^{1,*}(A)(z) + z^2H^{0,*}(A)(z) \\ &= (sW)(z) - z(sV)(z) + z^2 \\ &= H_+(Z)(z) - zH_+(X)(z) + z^2 . \end{aligned}$$

Finally, $UL_Y(z) = UI(z)UL(z)$ and $UI(z) = TS(z) = (1 - S(z))^{-1}$. A short calculation completes the proof. \square

(e) Presentations of graded Lie algebras.

Let $L = L_{\geq 1}$ be a graded Lie algebra. We may always write $L = \mathbb{L}_V / J$ where $J \subset [\mathbb{L}_V, \mathbb{L}_V]$ is an ideal in the free graded Lie algebra \mathbb{L}_V . In this case a basis (v_α) of V is a minimal set of generators of L . Similarly the Lie bracket defines a representation of \mathbb{L}_V in J . Decompose $J = R \oplus J \cdot U\mathbb{L}_V$. Then a basis (r_β) of R is a minimal set of generators for the ideal J . The representation

$$L = \mathbb{L}(v_\alpha) / (r_\beta)$$

is called a *minimal presentation* of L .

Proposition 37.9 *With the notation above ($s^2 = \text{double suspension}$),*

(i) $sV \cong \text{Tor}_1^{UL}(\mathbb{Q}, \mathbb{Q})$.

(ii) $s^2R \cong \text{Tor}_2^{UL}(\mathbb{Q}, \mathbb{Q})$.

proof: (i) Indeed $V \cong \mathbb{L}_V / [\mathbb{L}_V, \mathbb{L}_V] = L/[L, L]$ and so $sV \cong \text{Tor}_1^{UL}(\mathbb{Q}, \mathbb{Q})$ by Example 1, §34(a).

(ii) Consider the Hochschild-Serre spectral sequence converging from $\text{Tor}_p^{UL}(\mathbb{Q}, \text{Tor}_q^{UJ}(\mathbb{Q}, \mathbb{Q}))$ to $\text{Tor}_{p+q}^{UL_V}(\mathbb{Q}, \mathbb{Q})$. Again by Example 1 of §34(a) we may identify $\text{Tor}_1^{UJ}(\mathbb{Q}, \mathbb{Q}) = s(J/[J, J])$ with the representation of UL induced by Lie bracket in J . It follows that

$$E_{0,1}^2 = \text{Tor}_0^{UL}(\mathbb{Q}, \text{Tor}_1^{UJ}(\mathbb{Q}, \mathbb{Q})) \cong s(J/[J, J] \otimes_{UL} \mathbb{Q}) \cong sR .$$

On the other hand since \mathbb{L}_V is free we have $\text{Tor}_{UL_V}^1(\mathbb{Q}, \mathbb{Q}) = sV$ and $\text{Tor}_{UL_V}^{>1}(\mathbb{Q}, \mathbb{Q}) = 0$ — cf. Proposition 21.4. Since $E_{1,0}^2 = \text{Tor}_1^{UL}(\mathbb{Q}, \mathbb{Q}) = sV$ it follows that the differential d^2 in the spectral sequence satisfies

$$d^2 : E_{2,0}^2 = \text{Tor}_2^{UL}(\mathbb{Q}, \mathbb{Q}) \xrightarrow{\cong} E_{0,1}^2 \cong sR . \quad \square$$

Again let $L = \mathbb{L}(v_\alpha)/(r_\beta)$ be a minimal presentation of a graded Lie algebra $L = L_{\geq 1}$. Then without loss of generality we may suppose the r_β are integral combinations of Lie brackets of the v_α . Put $\text{deg } v_\alpha = n_\alpha$ and $\text{deg } r_\beta = m_\beta$. Then \mathbb{L}_V is the homotopy Lie algebra of the space $X = \bigvee_\alpha S^{n_\alpha+1}$ and the r_β define a continuous map

$$f : Z = \bigvee_\beta S^{m_\beta+1} \rightarrow X = \bigvee_\alpha S^{n_\alpha+1} .$$

As in §37(d) set $Y = X \cup_f CZ$. Then as described there the homotopy Lie algebra L_Y is the direct sum of a sub Lie algebra and an ideal I , and the sub Lie algebra in question is exactly

$$L = \mathbb{L}(v_\alpha)/(r_\beta) .$$

Thus we may reinterpret Proposition 37.9 as

$$H_+(X) \cong \text{Tor}_1^{UL}(\mathbb{Q}, \mathbb{Q}) \quad \text{and} \quad sH_+(Z) \cong \text{Tor}_2^{UL}(\mathbb{Q}, \mathbb{Q}) .$$

In particular, L is *finitely presented* if there are only finitely many generator v_α and finitely many relations r_β and in this case $Y = X \cup_f CZ$ is a finite CW complex. Since L is a sub Lie algebra of L_Y we deduce:

Theorem 37.10 *Let $L = L_{\geq 1}$ be a finitely presented Lie algebra. Then there is a finite simply connected CW complex $Y = X \cup_f CZ$ whose homotopy Lie algebra L_Y is the direct sum*

$$L_Y = L \oplus I$$

of L as a sub Lie algebra and an ideal I . Moreover I is free as a graded Lie algebra and

$$UL_Y(z)^{-1} = (1 + z)UL(z)^{-1} - (z - H_+(Z)(z) + H_+(X)(z)) .$$

(f) The Löfwall-Roos example.

Here we construct a finite CW complex Y , due to Löfwall and Roos [112], such that the Hilbert series UL_Y is irrational and also L_Y contains an infinite dimensional abelian Lie algebra.

To begin, note that the cohomology algebra $H = H((S^2 \vee S^2) \times (S^2 \vee S^2))$ has the form $[\Lambda(a, b)/a^2, ab, b^2] \otimes [\Lambda(x, y)/x^2, xy, y^2]$ where a, b, x, y are classes of degree 2 corresponding to the four copies of S^2 . Put $V = \bigoplus_{i \geq 2} \mathbb{K}v_i$ with $\deg v_i = 2$

and define a relative Sullivan algebra

$$(H \otimes \Lambda V, d).$$

by setting $dv_2 = 0, dv_3 = (b + y)v_2 + ax$ and $dv_i = (b + (-1)^{i+1}y)v_{i-1}, i \geq 4$.

Now the minimal Sullivan model for H is the cochain algebra $(\Lambda W, d) = C^*(\mathbb{L}(\bar{a}, \bar{b})) \otimes C^*(\mathbb{L}(\bar{x}, \bar{y}))$, whose differential is the purely quadratic operator given by the Lie bracket. The quasi-isomorphism $(\Lambda W, d) \rightarrow (H, 0)$ extends to a wordlength preserving quasi-isomorphism of the form $(\Lambda W \otimes \Lambda V, D) \xrightarrow{\cong} (H \otimes \Lambda V, d)$. Thus it is also a morphism $(\Lambda W \otimes \Lambda V, D_2) \rightarrow (H \otimes \Lambda V, d)$, where D_2 is the quadratic part of D . However, $D = D_2$ in ΛW , and the quotient differential \bar{D} in ΛV satisfies $\bar{D} = \bar{d} = 0$, so that $\bar{D} = \bar{D}_2 = 0$. It follows that $(\Lambda W \otimes \Lambda V, D_2) \xrightarrow{\cong} (H \otimes \Lambda V, d)$.

Let $H^{(p)}(\Lambda W \otimes \Lambda V, D_2)$ be the cohomology represented by cocycles of wordlength p . Then $H^{(p)}(\Lambda W \otimes \Lambda V, D_2) = H^{(p)}(H \otimes \Lambda V, d)$ and a short calculation shows that bases for $H^{(1)}(H \otimes \Lambda V, d)$ and $H^{(2)}(H \otimes \Lambda V, d)$ are given by:

$$H^{(1)} : a, b, x, y, v_2$$

$$H^{(2)} : ax, ay, bx, by, av_2, xv_2, v_2^2 .$$

On the other hand (Example 1, §23(a)) a graded Lie algebra L is determined by the condition

$$C^*(L) = (\Lambda W \otimes \Lambda V, D_2) .$$

Moreover, $H^{(1)} = \text{Ext}_{UL}^1(\mathbb{Q}, \mathbb{Q})$ and $H^{(2)} = \text{Ext}_{UL}^2(\mathbb{Q}, \mathbb{Q})$ are dual to $\text{Tor}_1^{UL}(\mathbb{Q}, \mathbb{Q})$ and $\text{Tor}_2^{UL}(\mathbb{Q}, \mathbb{Q})$. Thus (Proposition 37.9) L is finitely presented with five generators in degree 1 and seven relations in degree 2. Let

$$Y = \left(\bigvee_1^5 S_i^2 \right) \cup \left(\bigvee_1^7 D_j^4 \right)$$

be the corresponding CW complex described in Theorem 37.10. Then L is a sub Lie algebra of L_Y and

$$UL_Y(z)^{-1} = (1 + z)UL(z)^{-1} - (z - 7z^3 + 5z^2) .$$

Finally, since $C^*(L) = (\Lambda W \otimes \Lambda V, D_2)$ we have $(sL)^\# = W \oplus V$ with Lie bracket dual to D_2 . Since $\bar{D}_2 = 0$ in ΛV it follows that there is a short exact sequence

$$0 \rightarrow I \rightarrow L \rightarrow L(\bar{a}, \bar{b}) \times \mathbb{L}(\bar{x}, \bar{y}) \rightarrow 0$$

where I is an abelian ideal in L with basis $\bar{v}_2, \bar{v}_3, \dots$, and $\deg \bar{v}_k = k - 1$. In particular

- L_Y contains the infinite dimensional abelian sub Lie algebra $\bigoplus_k \mathbb{Q}\bar{v}_k$.
- UL_Y^{-1} is the irrational power series

$$\frac{(1 + z)(1 - 2z^2)^2 \prod_{i=1}^{\infty} (1 - z^{2i})}{\prod_{i=1}^{\infty} (1 + z^{2i+1})} - (z - 7z^3 + 5z^2) .$$

Exercises

1. Let $i : X \rightarrow Y = X \cup D^{n+1}$. Prove that:

- (a) If $i : \mathbb{C}P^2 \rightarrow \mathbb{C}P^3$ denotes the natural inclusion then $\dim \ker \pi_*(\Omega i) - \dim \text{Coker } \pi_*(\Omega i) = 1$.
- (b) If $i : S^3 \vee S^3 \rightarrow S^3 \times S^3$ denotes the natural inclusion then $\pi_*(\Omega i)$ is surjective.
- (c) If $i : X \hookrightarrow X \vee S^n$, $n \geq 2$, denotes the natural inclusion then $\pi_*(\Omega i)$ is not surjective and $\dim \text{Coker } \pi_*(\Omega i) = \infty$.

2. Let X be a simply connected topological space with rational homology of finite type. Using Theorem 29.1, prove that if $\text{cat}_0 X = 2$ then $\text{cl}_0 X = 2$.

3. Let F be the homology fibre of the inclusion $i : X \hookrightarrow X \cup D^{n+1} = Y$ and let $\partial : \Omega Y \rightarrow f$ be the inclusion $\{*\} \times \Omega Y \hookrightarrow F \times_Y PY$. Prove that if $H_* \partial \neq 0$ then $\text{depth } H_*(\Omega Y) = 1$.

38 Poincaré Duality

In this section the ground ring \mathbb{k} is an arbitrary field of characteristic zero.

Suppose $A = \{A^i\}_{0 \leq i \leq n}$ is a finite dimensional commutative graded algebra such that $A^0 = \mathbb{k}$, and suppose ω_A is an element in the dual space $(A^n)^\sharp$. Define bilinear maps $\langle \cdot, \cdot \rangle : A^{n-p} \times A^p \rightarrow \mathbb{k}$ by

$$\langle a, b \rangle = \omega_A(a \cdot b), \quad a \in A^{n-p}, \quad b \in A^p.$$

Definition A is a *Poincaré duality algebra* with *fundamental class* ω_A if the bilinear maps $\langle \cdot, \cdot \rangle$ are all non-degenerate scalar products. In this case n is called the *formal dimension* of A .

If M is a compact simply connected manifold then its cohomology algebra $H^*(M)$ satisfies Poincaré duality [68] and this is the principal condition that a simply connected space must satisfy in order to have the rational homotopy type of a compact manifold [18].

In this section we consider the rational homotopy theory of simply connected topological spaces X whose cohomology satisfies Poincaré duality. The main results are:

- If X is rationally elliptic then $H^*(X)$ satisfies Poincaré duality.
- If $H^*(X)$ satisfies Poincaré duality then $e_0(X) = \text{cat}_0(X)$.
- Suppose X satisfies Poincaré duality with formal dimension n and write $X = Z \cup_f D^n$ so that $H^n(D^n, S^{n-1}) \xrightarrow{\cong} H^n(X)$. Then the element $\alpha \in (L_X)_{n-2}$ corresponding to $[f] \in \pi_{n-1}(X)$ is inert.

This section is organized into the following topics:

- (a) Properties of Poincaré duality.
- (b) Elliptic spaces.
- (c) LS category.
- (d) Inert elements.

(a) Properties of Poincaré duality.

Let A be a finite dimensional commutative graded algebra of the form $\mathbb{k} \oplus \{A^i\}_{1 \leq i \leq n}$ and suppose $\omega_A \in A^n$. The bilinear maps $\langle \cdot, \cdot \rangle$ defined above determine linear maps $\theta : A^{n-p} \rightarrow (A^p)^\sharp$ by

$$\theta(a)(b) = \omega_A(a \cdot b) = \langle a, b \rangle.$$

Since $(A^p)^\sharp = (A^\sharp)^{-p}$, we may regard θ as a linear map $A \rightarrow A^\sharp$ of degree $-n$.

Lemma 38.1

- (i) *A satisfies Poincaré duality if and only if θ is an isomorphism.*
- (ii) *If $B = \mathbb{k} \oplus \{B^i\}_{1 \leq i \leq m}$ is a second finite dimensional commutative graded algebra and if $A \otimes B$ satisfies Poincaré duality then so do A and B .*
- (iii) *If A is equipped with a filtration and the associated graded algebra satisfies Poincaré duality then so does A .*

proof: (i) is by definition. (ii) follows from $\theta_{A \otimes B} = \theta_A \otimes \theta_B$ and the fact that a tensor product is an isomorphism if and only if both tensorands are. (iii) is an obvious calculation. \square

Next consider a commutative differential graded algebra (A, d) , and note that $(A^\#, d^\#)$ is a chain complex.

Lemma 38.2

- (i) *If A is a Poincaré duality algebra and with fundamental class $\omega_A \in (A^n)^\#$ and if $d^\# \omega_A = 0$, then $H(A)$ is a Poincaré duality algebra with fundamental class $[\omega_A]$.*
- (ii) *Suppose $z \in A^{\text{even}}$ is a cocycle and define $(A \otimes \Lambda u, d)$ by $du = z$. If $H(A)$ is a Poincaré duality algebra, then $H(A \otimes \Lambda u, d)$ is a Poincaré duality algebra.*

proof: (i) Because $d^\# \omega_A = 0$, $\theta_A d = (-1)^n d^\# \theta_A$ and $\theta_{H(A)} = H(\theta_A)$ is an isomorphism.

(ii) This is a simple exercise left to the reader. \square

(b) Elliptic spaces.

Proposition 38.3 *If $(\Lambda V, d)$ is an elliptic Sullivan algebra (introduction to §32) then $H(\Lambda V, d)$ is a Poincaré duality algebra. Its formal dimension is $n = \sum_i \deg x_i - \sum_j (\deg y_j - 1)$, where (x_i) is a basis of V^{odd} and (y_j) is a basis of V^{even} .*

proof: Recall the odd spectral sequence defined in §32(b). Its first term is $(\Lambda V, d_\sigma)$ with $d_\sigma(V^{\text{even}}) = 0$ and $d_\sigma(V^{\text{odd}}) \subset V^{\text{even}}$. Proposition 32.4 asserts that $H(\Lambda V, d_\sigma)$ is finite dimensional.

Choose r sufficiently large that each $y_j^r = d_\sigma \Phi_j$ and extend $(\Lambda V, d_\sigma)$ to $(\Lambda V \otimes \Lambda U, d_\sigma)$ by assigning U the basis (u_j) and setting $d_\sigma u_j = y_j^r$. Then $(\Lambda V \otimes$

$\Lambda U, d_\sigma) \xrightarrow{\cong} \left(\left[\bigoplus_j \Lambda y_j / u_j^r \right] \otimes \Lambda V^{\text{odd}}, d_\sigma \right)$ and it follows from Lemma 38.2(ii)

that $H(\Lambda V \otimes \Lambda U, d_\sigma)$ satisfies Poincaré duality. On the other hand, $H(\Lambda V \otimes$

$\Lambda U, d_\sigma) = H(\Lambda V, d_\sigma) \otimes \Lambda(u_1 - \Phi_1, \dots, u_q - \Phi_q)$ and so Lemma 38.1(ii) asserts that $H(\Lambda V, d_\sigma)$ satisfies Poincaré duality.

Finally, Theorem 32.6 shows that $n = \sum_i \deg x_i - \sum_j (\deg y_j - 1)$ is the top degree in which both $(\Lambda V, d_\sigma)$ and $(\Lambda V, d)$ have non-vanishing cohomology. Since $H(\Lambda V, d_\sigma)$ is a Poincaré duality algebra, $H^n(\Lambda V, d_\sigma) = \mathbb{k}[z]$ and so this class must survive through the spectral sequence. Thus if E_p is the p -th term of the spectral sequence then $(E_p^n)^\# = \mathbb{k}\omega_p^\#$ and $d^\#\omega_p = 0$. By Lemma 38.2(i), each E_p is a Poincaré duality algebra. Hence the bigraded algebra associated to $H(\Lambda V, d)$ is a Poincaré duality algebra and thus so is $H(\Lambda V, d)$ (Lemma 38.1(iii)). \square

(c) LS category.

Theorem 38.4 *Let X be a simply connected topological space and let $(\Lambda V, d)$ be a minimal simply connected Sullivan algebra such that $H(X)$ and $H(\Lambda V, d)$ are Poincaré duality algebras. Then*

$$e_0(X) = \text{cat}_0 X \quad \text{and} \quad e(\Lambda V, d) = \text{cat}(\Lambda V, d) .$$

Corollary *If X and $(\Lambda V, d)$ are elliptic then $e_0(X) = \text{cat}_0 X$ and $e(\Lambda V, d) = \text{cat}(\Lambda V, d)$.*

proof of Theorem 38.4: Choose $z \in (\Lambda V)^\#$ so that $d^\#z = 0$ and z represents a fundamental class of $(\Lambda V, d)$. Define $\theta : (\Lambda V, d) \rightarrow ((\Lambda V)^\#, d^\#)$ by setting $\theta\Phi(\Psi) = z(\Phi \wedge \Psi)$, $\Phi, \Psi \in \Lambda V$. Then θ is a linear map of $(\Lambda V, d)$ -modules and $H(\theta)$ is an isomorphism because $H(\Lambda V, d)$ satisfies Poincaré duality.

On the other hand in §29(h) we introduced the invariants mcat and e for $(\Lambda V, d)$ -modules (M, d) in terms of a semifree resolution of (M, d) . In particular, these invariants coincide for quasi-isomorphic modules. Thus according to Theorem 29.16,

$$e(\Lambda V, d) = e((\Lambda V)^\#, d^\#) = \text{cat}(\Lambda V, d) .$$

Finally, the assertion for X follows from this via the minimal Sullivan model for X . \square

(d) Inert elements.

Theorem 38.5 (Halperin-Lemaire [85]) *Suppose $X = Z \cup_f D^n$ is a simply connected space such that $H^*(X)$ is a Poincaré duality algebra of formal dimension n , and $H^n(D^n, S^{n-1}) \xrightarrow{\cong} H^n(X)$. If the algebra $H^*(X)$ is not generated by a single element, then the element $\alpha \in (L_Z)_{n-2}$ corresponding to $[f] \in \pi_{n-1}(Z)$ is inert.*

proof: Let $(\Lambda V, d)$ be a minimal Sullivan model for X and extend it to a minimal relative Sullivan algebra $(\Lambda V \otimes \Lambda \bar{V}, d)$ such that $H(\Lambda V \otimes \Lambda \bar{V}, d) = \mathbb{k}$.

Thus the linear part of d will be an isomorphism $\bar{V} \xrightarrow{\cong} V$, which we denote by $\bar{v} \mapsto v$.

Because X is simply connected, $V = V^{\geq 2}$ and $d = 0$ in V^2 . Thus $V^2 = H^2(\Lambda V, d)$. Write $(\Lambda V)^n = J^n \oplus \mathbb{k}\Phi$, where Φ is a cocycle representing a basis element of $H^n(\Lambda V, d)$, and $J^n \supset (\text{Im } d)^n$. Poincaré duality implies that multiplication $H^2 \times H^{n-2} \rightarrow H^n$ is non-degenerate. It follows that there is a subspace $J^{n-2} \subset (\Lambda V)^{n-2}$ such that $J^{n-2} \oplus (\ker d)^{n-2} = (\Lambda V)^{n-2}$ and such that $V^2 \cdot J^{n-2} \subset J^n$. Now extend these subspaces to a differential ideal $(J, d) \subset (\Lambda V, d)$ by setting $J^k = 0, k < n-2, J^{n-1} = (\Lambda V)^{n-1}$ and $J^k = (\Lambda V)^k, k > n$. Again by Poincaré duality, $H^{n-1}(\Lambda V, d) = 0$ and so it follows that $(\Lambda V, d) \rightarrow (\Lambda V/J, d)$ is a quasi-isomorphism.

Denote $\Lambda V/J$ simply by A and denote the image of Φ by Ω . Then a Sullivan representative for $(A, d) \rightarrow (A/\mathbb{k}\Omega, d)$ is also a Sullivan representative for the inclusion $i : Z \rightarrow X$. Thus if we define $(A \oplus \mathbb{k}u, d)$ by setting $du = \Omega$ and $u \cdot A^+ = 0$ the composite $(\Lambda V, d) \xrightarrow{\cong} (A, d) \rightarrow (A \oplus \mathbb{k}u, d)$ is also equivalent to a Sullivan representative for i .

Extend this composite to a quasi-isomorphism $(\Lambda V \otimes \Lambda W, d) \xrightarrow{\cong} (A \oplus \mathbb{k}u, d)$ from a relative Sullivan algebra $(\Lambda V \otimes \Lambda W, d)$. Then Proposition 15.5 identifies the quotient Sullivan algebra $(\Lambda W, \bar{d})$ as a Sullivan model for the homotopy fibre of i . Thus by Theorem 37.3 we have only to show that $(\Lambda W, \bar{d})$ is a Sullivan model of a wedge of spheres.

Now, as observed in Lemma 14.2, we have quasi-isomorphisms

$$\begin{aligned} (\Lambda W, \bar{d}) &\xleftarrow{\cong} (\Lambda V \otimes \Lambda W, d) \otimes_{\Lambda V} (\Lambda V \otimes \Lambda \bar{V}, d) \\ &= (\Lambda V \otimes \Lambda W \otimes \Lambda \bar{V}, d) \\ &\xrightarrow{\cong} ((A \oplus \mathbb{k}u) \otimes \Lambda \bar{V}, d). \end{aligned}$$

Suppose now that the least integer r such that $V^r \neq 0$ is odd. In this case we shall construct a quasi-isomorphism $(B, 0) \xrightarrow{\cong} ((A \oplus \mathbb{k}u) \otimes \Lambda \bar{V}, d)$ with $B^+ \cdot B^+ = 0$. By the Example of §12(c), $(B, 0)$ is a commutative model for a wedge of spheres, and hence $(\Lambda W, \bar{d})$ will be the Sullivan model for the wedge.

For this observe that $H^r(\Lambda V, d) = V^r = A^r$. Choose $v \neq 0$ in A^r and (by Poincaré duality) a cocycle $z \in A^{n-r}$ such that $vz = \Omega$. Then $A^+ = \mathbb{k}v \oplus I$, where I is the differential ideal in A of elements a satisfying $za = 0$. Extend \bar{v} to a basis $\bar{v}, \bar{v}_1, \dots, \bar{v}_k, \dots$ of $\Lambda \bar{V}$ with $\text{deg } \bar{v}_k \leq \text{deg } \bar{v}_{k+1}$ and define $\theta : \Lambda \bar{V} \rightarrow \Lambda \bar{V}$ by $\theta(\bar{v}^s \alpha) = \frac{\bar{v}^{s+1}}{s+1} \alpha, \alpha \in \Lambda(\bar{v}_1, \dots, \bar{v}_k, \dots)$.

Now $d\bar{v} = v$. Suppose $d\bar{v}_q \in I \otimes \Lambda \bar{V}$ for $1 \leq q < k$. Then $d\bar{v}_k = v \otimes \Psi + w, \Psi \in \Lambda(\bar{v}, \dots, \bar{v}_{k-1}), w \in I \otimes \Lambda \bar{V}$, and $d(\bar{v}_k - \theta\Psi) \in I \otimes \Lambda \bar{V}$. Replace \bar{v}_k by $\bar{v}_k - \theta\Psi$ and continue in this way to arrange that $d\bar{v}_i \in I \otimes \Lambda \bar{V}$ for all $i \leq k$. Let $B^+ \subset (A \oplus \mathbb{k}u) \otimes \Lambda \bar{V}$ consist of the elements of the form $u \otimes \Psi - z \otimes \theta\Psi, \Psi \in \Lambda \bar{V}$. Since $vz = \Omega$ and $Iz = 0$ it follows that $d(B^+) = 0$ and $B^+ \cdot B^+ = 0$. Since $H(A \otimes \Lambda \bar{V}) = \mathbb{k}$ it is immediate that the inclusion of $B = \mathbb{k} \oplus B^+$ in $(A \oplus \mathbb{k}u) \otimes \Lambda \bar{V}$ is a quasi-isomorphism, as desired.

We now deal with the general case. Let ℓ be the least odd integer such that $V_\ell \neq 0$. We prove the theorem by induction on $N = \sum_{0 < i < \ell} \dim V^i$. The case $N = 0$ is the case above when the least positive integer r such that $V^r \neq 0$ is itself odd.

For the inductive step we may take r even and, as above, write $A^+ = kv \oplus I$ where v is a non zero element of degree r , z is a cocycle such that $vz = \Omega$ and $I = \{a \in A \mid az = 0\}$.

Now write $V = kv \oplus V_1$. Since \bar{v} has odd degree $H(\Lambda V \otimes \Lambda v, d)$ also satisfies Poincaré duality, with formal dimension $n + r - 1$ (Lemma 38.2(ii)). Moreover we have quasi-isomorphisms

$$(\Lambda V, \bar{d}) \xleftarrow{\cong} (\Lambda V \otimes \Lambda \bar{v}, d) \xrightarrow{\cong} (A \otimes \Lambda \bar{v}, d) \xleftarrow{\cong} (A_1, d)$$

where $A_1 \subset A \otimes \Lambda \bar{v}$ is the subalgebra $k \oplus (I \otimes \Lambda \bar{v}) \oplus k(v \otimes \bar{v})$. On the one hand this implies that $H(A, d)$ is a Poincaré duality algebra with top cohomology class represented by $\Omega \otimes \bar{v}$. On the other hand, it allows us to assume that the differential in $(A \otimes \Lambda \bar{V}, d)$ sends \bar{V}_1 into $A_1^+ \otimes \Lambda \bar{V}_1$.

Since the theorem is true by the induction hypothesis for $(\Lambda V_1, d)$ and since $d(u \otimes \bar{v}) = \Omega \otimes \bar{v}$ and $(u \otimes \bar{v})(A_1^+) = 0$ it follows that $(B, d) = ([A_1 \oplus k(u \otimes \bar{v})] \otimes \Lambda \bar{V}_1, d)$ is a commutative model for a wedge of spheres.

Finally, since $(A_1, d) \xrightarrow{\cong} (A \otimes \Lambda \bar{v}, d)$ it follows that

$$([A_1 \oplus (ku \otimes \Lambda \bar{v})] \otimes \Lambda \bar{V}_1, d) \xrightarrow{\cong} ((A \oplus ku) \otimes \Lambda V, d) .$$

This source algebra can be written as $B = B_1 \oplus (u - z \otimes \bar{v})\Lambda \bar{V}_1$.

By construction $d(u - z \otimes \bar{v}) = \Omega - \Omega = 0$ and $(u - z \otimes \bar{v})B^+ = 0$. It follows that $(u - z \otimes \bar{v})\Lambda \bar{V}_1$ consists entirely of cocycles that multiply B^+ to zero. Thus since (B_1, d) is a commutative model for a wedge of spheres so is (B, d) , and the theorem follows by induction. \square

Exercises

1. Let $f : M \rightarrow N$ be a continuous map between 1-connected n -dimensional compact manifolds. Suppose that $H_n(f; \mathbb{Q}) \neq 0$. Show that $\text{cat}_0(M) \geq \text{cat}_0(N)$.

2. Let $f : M \rightarrow N$ be a smooth map between 1-connected compact manifolds. Prove that if either

- (a) f is a fibration whose cohomology Serre spectral sequence collapses at the E_2 -term,

or else

- (b) or else, f is a locally trivial bundle whose fibre F satisfies $\chi(F) \neq 0$,

then $\text{cat}_0 M \geq \text{cat}_0 N$.

39 Seventeen Open Problems

We close this monograph with seventeen of our favourite problems, all of which remain open as this goes to press, and many of which are decades old. Other compilations of problems can be found in [46] and [147].

1. *Suppose F is a rationally elliptic space with non-zero Euler-Poincaré characteristic, and $F \rightarrow E \rightarrow B$ is a Serre fibration of simply connected spaces. Does the (rational) Serre spectral sequence always collapse at E_2 ?*

A positive answer was conjectured by Halperin in 1976. The cohomology of such spaces F has the form $H = \Lambda(x_1, \dots, x_n)/(f_1, \dots, f_n)$, where x_1, \dots, x_n have even degrees and f_1, \dots, f_n is a regular sequence in the polynomial algebra $\Lambda(x_1, \dots, x_n)$. Thus an equivalent formulation of the problem is:

For graded algebras of the form H is zero the only derivation of negative degree?

Positive answers to this question have been given in the cases that: all the x_i have the same degree ([161]), $n \leq 2$ ([146]), $n \leq 3$ ([113]), if F is a homogeneous space ([141]), and if each polynomial f_i is homogeneous with respect to wordlength ([120]). In [132] it is shown that the answer is positive in the generic case.

Essentially the same question has arisen in the context of deformation of singularities ([154], [36]) where attention is restricted to the case that $f_i = \frac{\partial f}{\partial x_i}$ for some single polynomial f .

2. *Suppose an r -torus acts continuously with finite isotropy groups on a closed simply connected manifold M . Is it true that $\dim H^*(M; \mathbb{Q}) \geq 2^r$?*

The *torus rank conjecture* asserts that the answer to this question is positive. It can be easily reformulated in terms of Sullivan models as follows:

Suppose a simply connected Sullivan algebra $\Lambda(V, \bar{d})$ whose cohomology satisfies Poincaré duality occurs as the Sullivan fibre of a relative Sullivan algebra of the form $(\Lambda(x_1, \dots, x_r) \otimes \Lambda V, d)$ with $\deg x_i = 2$, $1 \leq i \leq r$. If $H(\Lambda(x_1, \dots, x_r) \otimes \Lambda V)$ is finite dimensional, is it true that $\dim H(\Lambda V, \bar{d}) \geq 2^r$?

The torus rank conjecture has been established for homogeneous spaces ([83]), for homology Kähler manifolds ([4]), for $r \leq 3$ ([5]) and for cohomologically symplectic manifolds satisfying the hard Lefschetz theorem ([115]). It implies that if $L = L_{\geq 1}$ is an evenly graded finite dimensional Lie algebra over \mathbb{Q} , then $\dim \text{Ext}_{UL}^*(\mathbb{Q}, \mathbb{Q}) \geq 2^{\dim \text{centre}(L)}$.

3. *If X is any finite simply connected CW complex and if $N > \dim X$ is there a rationally elliptic CW complex Y such that $X \simeq_{\mathbb{Q}} Y_N$, Y_N the N -skeleton of Y ?*

This question has been attributed by Anick as a conjecture. The answer is obviously affirmative if $\pi_{\leq N}(X) \otimes \mathbb{Q}$ is concentrated in odd degrees and a positive answer is given in [106] for the case $\sum_{2i \leq N} \dim \pi_{2i}(X) \otimes \mathbb{Q} = 1$.

4. *If X is a rationally hyperbolic finite simply connected CW complex does L_X contain a free Lie algebra on two generators?*

A positive answer to this question would provide an ‘explanation’ for the exponential growth of L_X , and a positive answer was conjectured (separately) by Avramov and Felix in 1981. The case $\text{cat}_0 X = 2$ was settled in [58] and the far more general case that $\text{depth } L_X = 1$ was settled positively in [29]. The case when X is formal and $H^*(X)$ is evenly graded and generated by at most three elements is settled positively in [13].

5. *Suppose X is a simply connected space with rational homology of finite type. If $H^{\text{even}}(X; \mathbb{Q})$ and the image of the Hurewicz homomorphism are both finite dimensional does it follow that $H^*(X; \mathbb{Q})$ is finite dimensional?*

This is trivially true for formal spaces, because in this case a generating space for the algebra $H^*(X; \mathbb{Q})$ is dual to the image of the Hurewicz homomorphism. If $H^{\text{even}}(X; \mathbb{Q}) = 0$ then Baues’ theorem [19] states that X is rationally a wedge of spheres, which implies a positive answer in this case too.

This question has been referred to in the literature as the ‘Omnibus Conjecture’, the origin of the terminology being a false proof produced by the second author during a particularly slow (omnibus) train ride from Leuven to Louvain in 1981.

6. *Suppose X is a simply connected rationally hyperbolic finite CW complex of dimension n . Are there numbers $\lambda > 0$ and $C > 1$ such that*

$$\sum_{i=s+1}^{s+n-1} \dim \pi_i(X) \otimes \mathbb{Q} \geq \lambda C^s, \quad \text{all } s \geq 1?$$

A positive answer to this question was conjectured by the authors in the early 1980’s. The gap theorem (Theorem 33.3) establishes the weaker (!) inequality with λC^s replaced by 1. An important case where there is a positive answer is established by Lambrechts in [104]. When X is rationally hyperbolic the exponential growth of Theorem 33.2 implies that the Hilbert series $H_*(\Omega X)(z)$ has radius of convergence $\rho < 1$. Lambrechts gives a positive answer to this problem when the singularities of $H_*(\Omega X)(z)$ on the boundary circle of radius ρ are all poles. There are many examples of such spaces, and no examples where this condition is known to fail.

7. *Is the radical $R \subset L_X$ of a simply connected finite CW complex X of dimension n , concentrated in degrees $\leq 2(n - 1)$, and is $\dim R \leq n$?*

When X is elliptic all of L_X is concentrated in degrees $\leq 2(n-1)$, and $\dim L_X \leq 2 \dim(L_X)_{\text{even}} \leq \text{cat } X \leq n$, which motivated the authors to conjecture a positive answer to this question in 1982. A weaker question asks:

Are all rational Goltlieb elements of X of degree $\leq 2n-1$?

and in the same vein,

If X is rationally hyperbolic is there an $\alpha \in (L_X)_{\text{even}}$ of degree $\leq n-1$ such that $\text{ad } \alpha$ is not locally nilpotent?

The authors believe that the answer to both questions should be yes.

8. *Do the rational homotopy types of the configuration spaces of a simply connected compact manifold M depend only on the rational homotopy type of M ?*

The configuration space of k points in M is the subspace of points $(x_1, \dots, x_k) \in M \times \dots \times M$ such that $x_i \neq x_j$ for $i \neq j$. In [22] it is shown that the rational homology of the configuration space depends only on the rational homotopy type of M and in [103] and [150] a positive answer is given for smooth complex projective varieties.

9. *Let X be a finite simply connected CW complex. Is X rationally elliptic if and only if for each prime number p some p^r annihilates all the p -primary torsion in $\pi_*(X)$?*

A positive answer to this question was conjectured by J.C. Moore in the 1970's, and the Moore conjecture has been a focus of research in unstable homotopy ever since. In [117] it is shown that rationally elliptic spaces satisfy the Moore condition for all but finitely many primes. In [10] this is shown for 2-cones. The full Moore conjecture is known for spheres ([148] and [97]). A survey of progress as of 1988 is given in [138].

10. *Let X be a finite simply connected CW complex. Is it true that either $H_*(\Omega X; \mathbb{Z})$ has p torsion for all but finitely many primes p or else that $H_*(\Omega X; \mathbb{Z})$ has p torsion for only finitely primes p ?*

Note that if two finite simply connected CW complexes have the same rational homotopy type then they have the same homotopy type after inverting only finitely many primes, so that the question above depends only on the rational homotopy type of X . Moreover, by using 'integral' Sullivan models it is possible to compute $H_*(\Omega X; \mathbb{Z}_{(p)})$ for all but finitely many primes p directly from a finite dimensional commutative rational model for X . The question has a positive answer for rationally elliptic spaces X since [117] shows that then $H_*(\Omega X; \mathbb{Z})$ has p -torsion for only finitely many primes.

11. *If X is a simply connected, rationally hyperbolic, finite CW complex do the betti numbers $b_i = \dim H_i(\Omega X^{S^1}; \mathbb{Q})$ of the free loop space grow exponentially?*

A positive answer to this question was conjectured by Vigué in [153], where it is proved when X is a wedge of spheres or a manifold of LS category 2. A positive answer is given in [105] for non-trivial connected sums of manifolds. This conjecture is motivated by the fact that the fibration $\Omega X \rightarrow X^{S^1} \rightarrow X$ admits a section and the fact that $H_*(\Omega X; \mathbb{Q})$ grows exponentially. However there is a cautionary example in [153] of a rationally elliptic X such that $H_*(\Omega X; \mathbb{Q})$ grows like a cubic while $H_*(X^{S^1}; \mathbb{Q})$ grows only like a quadratic.

The original interest in the question arises from the fact that the betti numbers of X^{S^1} can be used to give a lower bound estimate for the number of geometrically distinct closed geodesics on X as a function of their length [74].

12. *Are all simply connected compact riemannian manifolds M with non-negative sectional curvature rationally elliptic?*

A positive answer to this question has been attributed to Bott as a conjecture, and in [24] a result is established in this direction. A positive answer in general would solve the Chern-Hopf conjecture that the Euler-Poincaré characteristic is non-negative and the Gromov conjecture [75] that $\dim H^*(M; \mathbb{Q}) \leq 2^n$, $n = \dim M$. It would also shown that the rationally hyperbolic manifold of [89] with a metric of positive Ricci curvature did not admit a metric of non-negative sectional curvature.

In a somewhat different direction Paternain [133] conjectures a positive answer to the question:

Are all simply connected compact riemannian manifolds with completely integrable geodesic flows rationally elliptic?

13. *Let X be a rationally hyperbolic finite simply connected CW complex. Is it true for some α in the homotopy Lie algebra of $B \text{aut}_1(X)$ that $\text{ad } \alpha$ is not locally nilpotent?*

Here $\text{aut}_1(X)$ is the monoid of continuous maps $f : X \rightarrow X$ homotopic to the identity, and the homotopy Lie algebra in question is just $\pi_*(\text{aut}_1(X)) \otimes \mathbb{Q}$ with the Samelson product. This question is posed by Salvatore in [136]. Note that if X is rationally elliptic the homotopy Lie algebra $\pi_*(\text{aut}_1(X)) \otimes \mathbb{Q}$ is finite dimensional. Thus this question provides another (conjectural) characterization of the elliptic-hyperbolic dichotomy.

A second question dealing with the rational homotopy type of $B \text{aut}_1(X)$ was raised by Schlessinger in 1976:

Does every simply connected space Y have the rational homotopy type of some $B \text{aut}_1(X)$?

14. Suppose given $i : X \rightarrow Y = X \cup_f D^{n+1}$ and assume $H^*(Y; \mathbb{Q})$ is a finite dimensional algebra not generated by a single element. If f is not inert does $\text{coker } \pi_*(i) \otimes \mathbb{Q}$ grow exponentially?

15. Suppose X, Y and Z are simply connected rational CW complexes with homology of finite type. Is it true that $X \times Z \simeq X \times Y$ implies $Z \simeq Y$?

This question has a positive answer when X, Y and Z are formal spaces ([25], [27]).

16. Let X be a simply connected rationally hyperbolic CW complex with homotopy Lie algebra L_X . Let $n_X = \dim X$ and set

$$r_k = \sum_{i=k+1}^{k+n_X-1} \dim(L_X)_i \quad \text{and} \quad m_k = \sum_{i=k+1}^{k+n_X-1} \dim(L_X/[L_X, L_X])_i .$$

Does $m_k/r_k \rightarrow 0$ as $k \rightarrow \infty$?

This question is motivated by the theorems that show that L_X has ‘lots’ of non-vanishing Lie brackets and by computer experiments that suggest that $[L_X, L_X]$ is large. A positive answer would assert that in sufficiently large degrees $[L_X, L_X]$ was arbitrarily close to all of L_X .

A stronger version of the question asks

$$\text{Is } \lim_{k \rightarrow \infty} (m_k/r_k)^{1/k} = 0?$$

and this is closely related to a problem in [105]:

If $(\Lambda V, d)$ is the Sullivan minimal model for X does the Hilbert series for ΛV have a strictly smaller radius of convergence than the Hilbert series for $H(\Lambda V, d_2) = \text{Ext}^{UL_X}(\mathbb{Q}, \mathbb{Q})$?

17. Find an explicit number $\lambda \in (0, 1)$ that is not the radius of convergence of the Hilbert series $H_*(\Omega X; \mathbb{Q})(z)$ of the loop space homology of a finite simply connected CW complex.

There are, up to homotopy type, only countably many simply connected finite CW complexes. Thus only countably many numbers, λ , appear as the radius of convergence of $H_*(\Omega X; \mathbb{Q})(z)$ in the question above. However the series for $S^{n+1} \vee S^{n+1} \vee \dots \vee S^{n+1}$ (r copies) is $(1 - rz^n)^{-1}$ with radius of convergence $(1/r)^{1/n}$. Thus the numbers λ appearing as radii of convergence form a dense subset of $[0, 1]$. Moreover these numbers λ can be transcendental as is shown by an example in [8].

References

- [1] J.F. Adams, On the cobar construction. *Proc. Nat. Acad. Sci. USA* **42** (1956), 409-412.
- [2] J.F. Adams and P.J. Hilton, On the chain algebra of a loop space. *Comment. Math. Helvetici* **30** (1956), 305-330.
- [3] C. Allday and S. Halperin, Lie group actions on spaces of finite rank. *Quart J. Math. Oxford (2)* **29** (1978), 69-76.
- [4] C. Allday and V. Puppe, Bounds on the torus rank, in *Transformation groups, Poznam 1985*. Lecture Notes in Mathematics 1217, Springer-Verlag (1986), 1-10.
- [5] C. Allday and V. Puppe, *Cohomological Methods in Transformation Groups*. Cambridge Studies in Advanced Mathematics 32, Cambridge University Press (1993).
- [6] D. Anick, A counterexample to a conjecture of Serre. *Annals of Math.* **115** (1982), 1-33, and **116** (1982), 661.
- [7] D. Anick, Non-commutative graded algebras and their Hilbert series. *Journal of Algebra* **78** (1982), 120-140.
- [8] D. Anick, Diophantine equations, Hilbert series and Undecidable spaces. *Annals of Math.* **122** (1985), 87-112.
- [9] D. Anick, A loop space whose homology has torsion of all orders. *Pacific J. Math.* **123** (1986), 257-262.
- [10] D. Anick, Homotopy exponents for spaces of category two. in *Algebraic Topology - Rational Homotopy*, Lecture Notes in Math. 1318 (1988), 24-52.
- [11] D. Anick, Hopf algebras up to homotopy. *J. of Amer. Math. Soc.* **2** (1989), 417-453.
- [12] M. Aubry, *Homotopy Theory and Models*. DMV Seminar Band 24, Birkhäuser, 1995.
- [13] L. Avramov, Free Lie subalgebras of the cohomology of local rings. *Trans. Amer. math. Soc.* **270** (1982), 589-608.
- [14] L. Avramov, Local Algebra and Rational Homotopy. In *Homotopie Algébrique et Algèbre Locale*. Astérisque 113-114, Société Mathématique de France (1984), 15-43.
- [15] L. Avramov, Torsion in loop space homology. *Topology* **25** (1986), 155-157.

- [16] L. Avramov and S. Halperin, Through the looking glass; a dictionary between rational homotopy theory and local algebra, in *Algebra, Algebraic Topology and their Interactions, Stockholm 1983* Lecture Notes in Mathematics **1183**, Springer Verlag 1986, 1–27.
- [17] I.K. Babenko and I.A. Taimanov, On non formal simply connected symplectic manifolds, *Preprint series, math.SG: 9811167v3*, 17 Dec. 1998.
- [18] J. Barge, Structures différentiables sur les types d'homotopie rationnelle simplement connexes. *Ann. Scient. Ec. Norm Sup.* **9** (1976), 1–33.
- [19] J.H. Baues, Rational homotopietypen. *Manuscripta Math.* **20** (1977), 119–131.
- [20] H. Baues, *Algebraic Homotopy*. Cambridge University Press, 1989.
- [21] H. Baues and J.M. Lemaire, Minimal models in homotopy theory. *Math. Ann.* **225** (1977), 219–242.
- [22] M. Bendersky and S. Gitler, The cohomology of certain function spaces. *Trans. Amer. Math. Soc.* **326** (1991), 423–440.
- [23] C. Benson and C.S. Gordon, Kähler and symplectic structure on nilmanifolds. *Topology* **27** (1988), 513–518.
- [24] M. Berger and R. Bott, Sur les variétés à courbure strictement positive. *Topology* **1** (1962), 301–311.
- [25] R. Body and R. Douglas, Rational homotopy and unique factorization. *Pacific J. of Math.* **75** (1978), 909–914.
- [26] R. Body and R. Douglas, Unique factorization of rational homotopy types. *Pacific J. of Math.* **90** (1980), 21–26.
- [27] R. Body, M. Mimura, H. Shiga and D. Sullivan, p -universal spaces and rational homotopy types. *Comment. Math. Helv.* **73** (1998), 427–442.
- [28] R. Bogvad and S. Halperin, On a conjecture of Roos. *Lecture Notes in Math* **1183** (1986), 120–127.
- [29] R. Bogvad and C. Jacobsson, Graded Lie algebras of depth one. *Manuscripta Math.* **66** (1989), 153–159.
- [30] A.K. Bousfield and V.K.A.M. Gugenheim, On PL de Rham theory and rational homotopy type. *Memoirs of the Amer. Math. Soc.* **179** (1976)
- [31] E. Brown, Twisted torsion product, I. *Annals of Math.* **69** (1959), 223–242.
- [32] E. Cartan, *La topologie des groupes de Lie*. Actualités Scientifiques et industrielles, **358**. Paris Hermann, 1936.

- [33] H. Cartan, Notions d'algèbre différentielle; applications aux groupes de Lie, aux variétés où opère un groupe de Lie. *Colloque de Topologie (Espaces Fibrés)* Bruxelles (1950), Liège et Paris (1951), 15-27.
- [34] H. Cartan, La transgression dans un groupe de Lie et dans un espace fibré principal. *Colloque de Topologie (Espaces Fibrés)* Bruxelles (1950), Liège et Paris (1951), 57-71.
- [35] H. Cartan and S. Eilenberg, *Homological Algebra*. Princeton University Press, 1956.
- [36] H. Chen, Nonexistence of negative weight derivations on graded Artin algebras: A conjecture of Halperin. *J. Algebra* **216** (1999), 1-12.
- [37] K.T. Chen, Iterated integrals of differential forms and loop space homology. *Annals of Math.* **97** (1973), 1033-1035.
- [38] C. Chevalley and S. Eilenberg, Cohomology theory of Lie groups and Lie algebras. *Trans. Amer. Math. Soc.* **63** (1948), 83-124.
- [39] L.A. Cordero, M. Fernandez and A. Gray, Symplectic manifolds with no Kähler structure. *Topology* **25** (1986), 375-380.
- [40] O. Cornea, Cone length and LS category. *Topology* **33** (1994), 95-111.
- [41] O. Cornea, There is just one cone length. *Trans. Amer. Math. Soc.* **344** (1994), 835-848.
- [42] P. Deligne, P. Griffiths, J. Morgan and D. Sullivan, Real homotopy theory of Kähler manifolds. *Invent. Math.* **29** (1975), 245-274.
- [43] G. de Rham, Sur l'analysis situs des variétés à n dimensions. *Journal de Mathématiques Pures et Appliquées* **10** (1931), 115-200.
- [44] J. Dugundji, *Topology*. Allyn and Bacon, Boston, 1965.
- [45] N. Dupont, A counterexample to the Lemaire-Sigrist conjecture, *Topology* **38** (1999), 189-196.
- [46] N. Dupont, Problems and Conjectures in rational homotopy theory: A survey. *Expo. Math.* **12** (1994) 323-352.
- [47] W.G. Dwyer, Strong convergence of the Eilenberg-Moore spectral sequence. *Topology* **13** (1974), 255-265.
- [48] S. Eilenberg and S. MacLane, On the group $H(\pi, n)$ I. *Annals of Math.* **58** (1953), 55-106.
- [49] S. Eilenberg and J.C. Moore, Homology and fibrations I: cotensor product and its derived functors. *Comment. Math. Helvetici* **40** (1986), 199-236.

- [50] Y. Félix, Caractéristique d'Euler homotopique. *Note aux Comptes-Rendus de l'Académie des Sciences de Paris* **291** (1980), 303-306.
- [51] Y. Felix, *La Dichotomie Elliptique-Hyperbolique en Homotopie Rationnelle*. Astérisque 176, Soc. Math. France, 1989.
- [52] Y. Félix et S. Halperin, Rational LS category and its applications. *Trans. Amer. Math. Soc.* **273** (1982), 1-38.
- [53] Y. Félix and S. Halperin, Formal spaces with finite dimensional rational homotopy. *Trans. Amer. Math. Soc.* **270** (1982), 575-588.
- [54] Y. Félix, S. Halperin, C. Jacobsson, C. Löfwall and J.-C. Thomas, The radical of the homotopy Lie algebra. *Amer. J. of Math.* **110** (1988), 301-322.
- [55] Y. Félix, S. Halperin and J.M. Lemaire, The rational L.S. category of products and of Poincaré duality complexes. *Topology* **37** (1998), 749-756.
- [56] Y. Felix, S. Halperin, J.-M. Lemaire and J.-C. Thomas, Mod p loop space homology. *Inventiones Math.* **95** (1989), 247-262.
- [57] Y. Félix, S. Halperin and J.-C. Thomas, L.S. catégorie et suite spectrale de Milnor-Moore (une nuit dans le train). *Bull. Soc. Math. France* **111** (1983), 89-96.
- [58] Y. Félix, S. Halperin and J.-C. Thomas, Sur l'homotopie des espaces de catégorie 2. *Math. Scand.* **55** (1984), 216-228.
- [59] Y. Félix, S. Halperin and J.-C. Thomas, Loop space homology of spaces of LS category one and two. *Math. Annalen* **287** (1990), 377-386.
- [60] Y. Felix and J.-C. Thomas, Sur la structure des espaces de L.S. catégorie deux. *Illinois J. Math.* **30** (1986), 175-190.
- [61] J. Friedlander and S. Halperin, An arithmetic characterization of the rational homotopy groups of certain spaces. *Inventiones Math.* **53** (1979), 117-133.
- [62] T. Ganea, Lusternik-Schnirelmann category and strong category. *Illinois J. Math.* **11** (1967), 417-427.
- [63] T. Ganea, Induced fibrations and cofibrations. *Trans. Amer. Math. Soc.* **127** (1967), 442-459.
- [64] M. Ginsburg, On the Lusternik-Schnirelmann category. *Annals of Math.* **77** (1963), 538-551.
- [65] A. Gomez Tato, Modèles minimaux résolubles. *Journal of Pure and Applied Algebra* **85** (1993), 43-56.

- [66] A. Gomez-Tato, S. Halperin and D. Tanré, Non simply connected homotopy theory. *Preprint* .
- [67] D. Gottlieb, Evaluation subgroups of homotopy groups. *Amer. J. of Math.* **91** (1969), 729-756.
- [68] M. Greenberg, *Lectures on Algebraic Topology*. W.A. Benjamin (1966)
- [69] W. Greub, S. Halperin and R. Vanstone, *Connections, Curvature and Cohomology I*. Academic Press (1972).
- [70] W. Greub, S. Halperin and R. Vanstone, *Connections, Curvature and Cohomology II*. Academic Press (1973).
- [71] W. Greub, S. Halperin and R. Vanstone, *Connections, Curvature and Cohomology III*. Academic Press (1976).
- [72] P.A. Griffiths and J.W. Morgan, *Rational Homotopy Theory and Differential Forms*, Progress in Mathematics, 16, Birkhäuser, 1981.
- [73] D. Gromoll and W. Meyer, Periodic geodesics on a compact riemannian manifold. *J. Differential Geometry* **3** (1969), 493-510.
- [74] M. Gromov, Homotopical effects of dilatations. *J. Differential Geometry* **13** (1978), 303-310.
- [75] M. Gromov, Curvature, Diameter and Betti numbers. *Comment. Math. Helvetici* **56** (1981), 179-195.
- [76] K. Grove and S. Halperin, Contributions of rational homotopy theory to global problems in geometry. *Publ. I.H.E.S.* **56** (1982), 379-385.
- [77] K. Grove and S. Halperin, Dupin hypersurfaces, group actions and the double mapping cylinder. *J. Differential Geometry* **26** (1987), 429-459.
- [78] A. Haefliger, Rational homotopy of the space of sections of a nilpotent bundle. *Trans. Amer. Math. Soc.* **273** (1982), 609-620.
- [79] R. Hain, *Iterated Integrals and Homotopy Periods*. Memoirs of the Amer. Math. Soc. 291 (1984).
- [80] R. Hain, The geometry of the mixed Hodge structure on the fundamental group. In *Algebraic Geometry, Bowdoin, PSPM*, **46** (1987), 247-282.
- [81] R. Hain, The de Rham homotopy theory of complex algebraic varieties. *K-theory* **1** (1987), 271-324 and 481-497.
- [82] S. Halperin, Lectures on Minimal models. *Mémoires de la société Mathématiques de France* **230** (1983).

- [83] S. Halperin, Rational homotopy and torus actions. In *Aspects of topology*, Mem. H. Dowker, London Math. Soc. Lect. Note Ser. 93 (1985), 293-306.
- [84] S. Halperin and J.-M. Lemaire, Suites inertes dans les algèbres de Lie graduées. *Math. Scand.* **61** (1987), 39-67.
- [85] S. Halperin and J.-M. Lemaire, Notions of category in differential algebra. *Lecture Notes in Mathematics*, **1318**, (1988), 138-154.
- [86] S. Halperin and J.D. Stasheff, Obstructions to homotopy equivalences. *Adv. in Math.* **32** (1979), 233-279.
- [87] S. Halperin et M. Vigué-Poirrier, The homology of a free loop space. *Pacific J. of Math.* **147** (1991), 311-324.
- [88] K. Hasegawa, Minimal models of nilmanifolds. *Proc. Amer. Math. Soc.* **106** (1989), 65-71.
- [89] M. Hernandez-Andrade, A class of compact manifolds with positive Ricci curvature. *Proc. Symp. Pure Math.* **27** (1975), 73-87.
- [90] K. Hess, A proof of Ganea conjecture for rational spaces. *Topology* **30** (1991), 205-214.
- [91] K. Hess, A history of rational homotopy theory. In *History of Topology*, Ed. I.M. James, Elsevier Sciences, 1999.
- [92] G. Hochschild and J.P. Serre, Cohomology of Lie algebras. *Annals of Math.* **57** (1953), 591-603.
- [93] W. Hurewicz, Beitrage zur Topologie der Deformationen I-I IV. *Proc. Koninkl. Akad. Wetenschap Amsterdam.* **38** (1935), 111-119, 521-528, and **39** (1936), 117-126, 215-224.
- [94] K. Iwasawa, On some types of topological groups. *Ann. of Math.* **50** (1949), 507-748.
- [95] N. Iwase, Ganea's conjecture on Lusternik-Schnirelmann category. *Bull. London Math. Soc.* **30** (1998), 623-634.
- [96] I. James, On category in the sense of Lusternik-Schnirelmann. *Topology* **17** (1978), 331-348.
- [97] I. James, On the suspension triad of a sphere. *Ann. of Math.* **63** (1956), 407-429.
- [98] B. Jessup, Rational L.-S. category and a conjecture of Ganea. *Journal of Pure and Applied Algebra* **65** (1990), 57-67.
- [99] B. Jessup, Holonomy nilpotent fibrations and rational Lusternik-Schnirelmann category. *Topology* **34** (1995), 759-770.

- [100] B. Jessup and A. Murillo-Mas, Approximating rational spaces with elliptic complexes and conjecture of Anick. *Pacific J. Math.* **181** (1997), 269-280.
- [101] R. Kaenders, *On De Rham Homotopy Theory for Plane Algebraic Curves and their Singularities*. Thesis, Nijmegen, 1997.
- [102] J. L. Koszul, Sur un type d'algèbre différentielle en rapport avec la transgression. *Colloque de Topologie (Espaces Fibrés) Bruxelles 1950, Liège et Paris (1951)*, 73-81.
- [103] I. Kriz, On the rational homotopy type of configuration spaces. *Annals of Mathematics* **139** (1994), 227-237.
- [104] P. Lambrechts, Analytic properties of Poincaré series of spaces. *Topology* **37** (1998), 1363-1370.
- [105] P. Lambrechts, Croissance des nombres de Betti des espaces de lacets, Thèse Louvain-La-Neuve (1995)
- [106] L. Lechuga and A. Murillo, Complexity in rational homotopy. *Topology* **39** (1999), 89-94.
- [107] D. Lehmann, *Théorie homotopique des formes différentielles*. Astérisque **45**, Soc. Math. France, 1977.
- [108] J.-M. Lemaire, *A finite complex whose rational homotopy is not finitely generated*. Lecture Notes in Mathematics 196 (1971), 114-120.
- [109] J.-M. Lemaire, *Algèbres connexes et homologie des espaces de lacets*. Lecture Notes in Math. 422, Springer-Verlag, 1974.
- [110] J.-M. Lemaire, "Autopsie d'une meurtre" dans l'homologie d'une algèbre de chaînes. *Ann. Scient. Ec. Norm. Sup.* **11** (1978), 93-100.
- [111] J.M. Lemaire and F. Sigrüst, Sur les invariants d'homotopie rationnelle liés à la L.S. catégorie. *Comment. Math. Helvetici* **56** (1981), 103-122.
- [112] C. Löfwall and J.E. Roos. Cohomologie des algèbres de Lie graduées et séries de Poincaré-Betti non rationnelles. *Note aux Comptes-Rendus Acad. Sci. Paris* **290** (1980), 733-736.
- [113] G. Lupton, Note on a conjecture of Stephen Halperin's. *Springer Lecture Notes in Math.* **1440** (1990), 148-163.
- [114] G. Lupton and J.F. Oprea, Symplectic manifolds and formality. *Journal Pure and Applied Algebra.* **91** (1994) 193-207.
- [115] G. Lupton and J. Oprea, Cohomologically symplectic spaces: toral actions and the Gottlieb group. *Trans. Amer. Math. Soc.* **347** (1995), 261-288.

- [116] L. Lusternik and L. Schnirelmann, *Méthodes topologiques dans les problèmes variationels*. Actuelles scientifiques et industrielles, 188, Paris, Hermann, 1934.
- [117] C. McGibbon and C. Wilkerson, Loop space of finite complexes at large primes. *Proc. Amer. Math. Soc.* **96** (1986), 698-702.
- [118] S. MacLane, *Homology*, Springer-Verlag, Berlin and New York, 1975.
- [119] M. Majewski, A proof of the Baues-Lemaire conjecture in rational homotopy theory. *Rend. Circ. Mat. Palermo. Suppl.* **30** (1993), 113-123.
- [120] M. Markl, Towards one conjecture on collapsing of Serre spectral sequence. in *Geometry and physics, Proc. 9th Winter Sch., Srni/Czech. 1989*, Suppl. *Rend. Circ. Mat. Palermo*, 22 (1990), 151-159.
- [121] C.R.F. Maunder, *Algebraic Topology*. Van Nostrand Reinhold Company, London, 1970.
- [122] J.P. May, *Simplicial object in Algebraic Topology*. University of Chicago Press, 1967.
- [123] W. Meier, Rational universal fibrations and flag manifolds. *Math. Ann.* **258** (1982), 329-340.
- [124] S.A. Merkulov, Formality of canonical symplectic complexes and Frobenius manifold. *Preprint series, math. SG:9805072*, 15 May 1998.
- [125] J. Milnor, Construction of the universal bundles, I and II. *Annals of Math.* **63** (1956), 272-284 and 430-436.
- [126] J. Milnor, The geometric realization of a semisimplicial complex. *Annals of Math.* **65**, (1957) 357-352.
- [127] J. Milnor and J.C. Moore, On the structure of Hopf algebras. *Annals of Math.* **81** (1965), 211-264.
- [128] J. Milnor and J.D. Stasheff, *Characteristic classes*. Princeton Univ. Press, 1974.
- [129] J. Neisendorfer and P. Selick, Some examples of spaces with or without exponents. in *Current trends in Algebraic Topology*, CMS Conf. Proc. 2 (1982), 343-357.
- [130] K. Nomizu, On the cohomology of compact homogeneous spaces of nilpotent Lie groups. *Annals of Math.* **59** (1954), 531-538.
- [131] J. Oprea, *Gottlieb Groups, Group Actions, Fixed Points and Rational Homotopy*. Lecture Notes series 29, Research Institute of Math. Seoul National University (1995).

- [132] S. Papadima et L. Paunescu, Reduced weighted complete intersection and derivations. *Journal of Algebra* **183** (1996), 595-604.
- [133] G. Paternain, On the topology of manifolds with completely integrable geodesic flows. *Ergodic Theory Dyn. Syst.* **12** (1992), 109-122.
- [134] D. Quillen, *Homotopical algebra*. Lecture Notes in Math. **43**, Springer-Verlag, 1967.
- [135] D. Quillen, Rational homotopy theory. *Annals of Math.* **90** (1969), 205-295.
- [136] P. Salvatore, Rational homotopy nilpotency of self-equivalences. *Topology Appl.* **77** (1997), 37-50.
- [137] H. Scheerer and D. Tanré, Fibrations à la Ganea. *Bull. Belg. Math. Soc.* **4** (1997), 333-353.
- [138] P. Selick, Moore conjectures. In *Algebraic Topology - Rational Homotopy*, Lecture Notes in Math. **1318** (1988), 219-227.
- [139] J.P. Serre, *Lie algebras and Lie Groups*. New-York, Benjamin, 1965.
- [140] J.P. Serre, *Algèbre Locale - Multiplicités*. Lecture Notes in Math. **11**, Springer-Verlag, 1965.
- [141] H. Shiga and M. Tezuka, Rational fibrations, Homogeneous spaces with positive Euler characteristics and Jacobians. *Ann. Inst. Fourier* **37** (1987), 81-106.
- [142] E.H. Spanier, *Algebraic Topology*. McGraw Hill, Academic Press, 1966.
- [143] D. Sullivan, *Geometric Topology - 1 : Localization, Periodicity, and Galois Symmetry*. MIT Press, 1970.
- [144] D. Sullivan, Infinitesimal computations in topology. *Publ. I.H.E.S.* **47** (1977) 269-331.
- [145] D. Tanré, *Homotopie Rationnelle : Modèles de Chen, Quillen, Sullivan*. Lecture Notes in Mathematics **1025**, Springer-Verlag, 1983.
- [146] J.C. Thomas, Rational homotopy of Serre fibrations. *Ann. Inst. Fourier* **331** (1981), 71-90.
- [147] J.C. Thomas, Homologie de l'espace des lacets, problèmes et questions. *Journal of Pure and Applied Algebra* **91** (1994), 355-379.
- [148] H. Toda, On the double suspension E^2 . *J. Inst. Polytech. Osaka City Univ.* **A7** (1956), 103-145.

- [149] G. Toomer, Lusternik-Schnirelmann category and the Milnor-Moore spectral sequence. *Math. Zeitschrift* **138** (1974), 123-143.
- [150] B. Totaro, Configuration spaces of algebraic varieties. *Topology* **35** (1996), 1057-1067.
- [151] G. Triantafillou, Equivariant Rational Homotopy Theory. In *Equivariant homotopy and cohomology theory*, C.B.R.M. 91 (1996), 27-32.
- [152] M. Vigué-Poirrier et D. Sullivan, The homology theory of the closed geodesic problem. *Journal of Differential Geometry* **11** (1976), 633-644.
- [153] M. Vigué-Poirrier, Homotopie rationnelle et nombre de géodésiques fermées. *Ann. Scient. Ecole Norm. Sup.* **17** (1984), 413-431.
- [154] J.M. Wahl, Derivations, automorphisms and deformations of quasi-homogeneous singularities. In *Proc. Symp. Pure Math.* **40** (1983), 613-624.
- [155] C. Watkiss, *Cohomology of principal bundles in semisimplicial theory*. Thesis, Toronto (1974).
- [156] A. Weil, Sur les théorèmes de de Rham. *Comment. Math. Helv.* **26** (1952), 119-145.
- [157] G. Whitehead, *Elements of homotopy theory*. Graduate Text in Math. 61 Sprinberg-Verlag, New York Inc., 1978.
- [158] G. Whitehead, The homology suspension. *Colloque de Topologie Algébrique*, Louvain (1957), 89-95.
- [159] J.C.H. Whitehead, On adding relations to homotopy groups. *Ann. of Math.* **42** (1941), 409-428.
- [160] J.C.H. Whitehead, Combinatorial homotopy I and II. *Bull. Amer. Math. Soc.* **55** (1949), 213-245 and 453-496.
- [161] O. Zariski and P. Samuel, *Commutative Algebra*. Graduate Texts in Math. 28, Springer-Verlag, 1975.

Index

- Alexander-Whitney map 53, 477
- Bar construction 268, 277
 - of an enveloping algebra 305
- Borel construction 36
 - Minimal Sullivan model for B_G 217
 - Sullivan model for the Borel construction 219
- Bundle
 - Associated fibre bundle 36
 - Fibre bundle 32
 - Milnor's universal G -bundle 36
 - Principal G -bundle 35
- CW complex 4
 - CW p -complex 102
 - Cellular approximation theorem 9
 - Cellular chain model 60
 - Cellular chain model for a fibration 90
 - Cellular chain model of a space 59
 - Cellular map 5
 - Cellular models theorem 12
 - Product of 7
 - Quotient of 7
 - Relative CW complex 5
 - Subcomplex 5
 - Wedge of CW complexes 7
 - Whitehead lifting lemma 12
- Cartan-Eilenberg-Chevalley construction on a dgl
 - (see chain coalgebra on a dgl) 301
- Cartan-Serre Theorem 231
- Cell attachment 173
 - Sullivan model 173
- Cellular approximation theorem 9
- Cellular chain model 59, 60
- Chain algebra 46
 - Chain algebra on a loop space 343
- Chain coalgebra
 - Chain coalgebra on a dgl 301
 - Chain coalgebra on a dgl, $C_*(L)$ 301
- Chain complex 43
 - $C_*(L; UL)$ 302, 305
 - Cellular chain complex 59
 - Chain complex of A -modules 273
 - Chain complex of UL -modules 464
 - Chain complex on a dgl 305
 - Normalized singular chain complex 52
 - of finite length 475
- Cobar construction 271
- Cochain algebra 46
 - $C^*(X; \mathbb{k})$ 65
 - Cochain algebra $A_{PL}(X)$ 121
 - Cochain algebra on a dgl 313, 314
- Cochain complex 43
 - Normalized singular cochain complex 65
- Cofibration 15
- Cohomology
 - De Rham Theorem 128
 - Lie algebra cohomology 320
 - Relative singular cohomology 66
 - Singular cohomology 65
- Commutative model 116
- Complex projective space 6
 - Lie model 333
- Cone length 360, 362
 - Rational cone length 370, 372, 374, 382, 388
- Cup product 65
- Cup-length 366
 - Rational cup length 370, 387
- De Rham Theorem 128
- Depth of a Lie algebra 492, 493
- Depth of an algebra 474, 486
- Differential graded algebra 46

- dga Homotopy 344
- Direct product 47
- Fibre product 47
- Tensor product 47
- Differential graded coalgebra 48
- Differential graded Hopf algebra 297
- Differential graded Lie algebra 296
 - Module 296
- Differential model on a dga
 - Semifree model 183
- Differential module on a dga 46
 - Equivalence 68
 - Homotopy of maps 68
 - Lifting property 70
 - Semifree module 69, 262
- Dupont example 388
- Eilenberg-MacLane space 62
 - Simplicial construction 246
 - Sullivan model 201
- Euler-Poincaré characteristic 49, 444
- Existence of models 182
- Exponents 441
- Ext 275, 465
- Fibration 23
 - G -(Serre) fibration 28
 - Lifting property 23, 24
 - Path space fibration 29
 - Serre fibration 23, 33
- Fibre of the model 196
- Formal dimension 441
- Ganea spaces 357, 366
 - Ganea fibres 357, 479
- Ganea's fibre-cofibre construction 355
- Ginsburg's Theorem 399
- Global dimension 474
- Gottlieb groups 377, 378, 392
- Grade 474
 - Projective grade 474, 476, 481
- Graded algebra 43
 - Commutative 45
 - Free commutative 45
 - Tensor algebra 45
 - Tensor product 44
- Graded coalgebra 47, 299
 - Coderivation 301
 - Primitively cogenerated 299
- Graded Hopf algebra 288
 - Primitive element 288
- Graded Lie algebra 283
 - Abelian Lie algebra 283, 285
 - Adjoint representation 284, 422
 - Derivation 284
 - Derived sub Lie algebra 283
 - Free graded Lie algebra 289, 316
 - Lie algebra cohomology 320
 - Lie bracket 283
 - Module 283
 - Morphism 283
 - Product 284
 - Representation 284
 - Universal enveloping algebra 285
- Graded module 40
 - Suspension 41
 - Tensor product 41
- Graphs (n -colourable) 440
- Hess' Theorem 393
- Hilbert series 49
- Holonomy fibration 30, 342, 378
- Holonomy representation
 - for a fibration 415, 418
 - for a relative Sullivan algebra 416, 418
- Homogeneous space 218, 435
 - Sullivan model 219
- Homology
 - Singular homology 52
- Homotopy
 - Based homotopy 3
 - Homotopy rel 3
 - Homotopy equivalence 3, 242
 - Weak homotopy equivalence 12, 14, 58
- Homotopy fibre 30, 196, 334
- Homotopy groups 10, 208, 452
 - Cartan-Serre Theorem 231
 - Long exact sequence 26, 213
 - Rational homotopy groups 453
- Homotopy Lie algebra
 - of a space 292, 294, 295, 325, 432

- of a Sullivan algebra 295, 317, 475
- of a suspension 326
- Hurewicz homomorphism 58, 210, 231, 234, 293, 326
- Iwase example 407
- Jessup's Theorem 424
- Kähler manifold 162
- Koszul-Poincaré series 444
- Lie group 216
 - Matrix Lie group 219
 - Right invariant forms on a Lie group 161
 - Sullivan model for a Lie group 161
 - Sullivan model for the orbit space X/G 219
- Lie model for a space 322
 - Cellular Lie model 323, 331
 - Free Lie model 322, 324, 383
 - Lie model for a wedge 331
 - Lie model of a wedge of spheres 331
 - Lie model of the product 332
 - Lie models for adjunction spaces 328
- Lie model of a dgl 309
 - Free Lie extension 310
 - Minimal Lie model 311
 - Minimal Lie model for a Sullivan algebra 316
- Localization 108
 - \mathcal{P} -local group 102
 - \mathcal{P} -local space 102
 - $CW_{\mathcal{P}}$ -complex 102
 - Cellular localization 108
 - Relative $CW_{\mathcal{P}}$ complex 104
- Loop space 29, 340
 - ΩX -spaces 476
 - Chain algebra on a loop space 88, 343, 347
 - Decomposability 449
 - LS category 380
 - Rational product decomposition 228, 229
- Loop space homology
 - Basis 230
 - Primitive subspace 230
- Loop space homology algebra
 - Milnor Moore Theorem 293
- Loop space homology $H_*(\Omega X; \mathbb{k})$
 - Depth 486
- Loop space homology algebra $H_*(\Omega X; \mathbb{k})$
 - 224, 232, 458
- Lusternik-Schnirelmann category (of algebras and modules)
 - of a differential module 401
 - of a Sullivan algebra 381, 384, 488
- Lusternik-Schnirelmann category (of spaces) 351, 362, 406, 486
 - of a continuous map 352, 481
 - of free loop spaces 376
 - of loop spaces 380
 - of Postnikov fibres 376
 - Rational LS category 386, 387, 388
 - Rational LS category of a space 370, 371, 374, 432
 - Rational LS category of smooth manifolds 396
 - Whitehead LS category 353
- Mapping Theorem 375, 389, 411
- Milnor-Moore Theorem 293
- Nilmanifolds 162
- Poincaré-Birkhoff-Witt Theorem 286, 287
- Polynomial differential forms 122
- Product length, nil 381, 382
- Projective dimension 278, 474, 481
- Quasi-isomorphisms 152
- Quillen construction $\mathcal{L}(C, d)$ 306, 307
- Quillen plus construction 212
- Radius of convergence 459
- Rational elliptic space 434
- Rational hyperbolic space 452
- Rational space 102
 - Rational cellular model 111
 - Rational homotopy equivalence 111, 383

- Rational homotopy type 111
- Rationalization 108, 386
- Regular sequence 437
- Resolution
 - $H_*(\Omega Y)$ -free resolution of $H_*(F)$ 483
 - Eilenberg-Moore resolution 279, 480
 - Projective (free) resolution 274
 - Semifree resolution 69, 71, 278
 - The Milnor resolution of \mathbb{k} 478, 480
- Simplex
 - Degeneracy map 52
 - Degenerate 52
 - Face map 52
 - Linear simplex 52
 - Singular n -simplex 52
- Simplicial morphism 117
- Simplicial object 116
 - Extendable simplicial object 118, 240
 - Milnor realization 238
 - Simplicial cochain algebra 117
 - Simplicial set 117
- Spatial realization 248, 386
 - Homotopy groups 250
 - of a relative Sullivan model 248
- Spectral sequence 260, 261
 - Comparison Theorem 265
 - Eilenberg-Moore spectral sequence 280
 - Filtered module 261, 266
 - Hochschild-Serre spectral sequence 464
 - Milnor-Moore spectral sequence 317, 318, 319, 399
 - Odd spectral sequence 438
- Sphere 2, 7, 11
 - \mathcal{P} -local n -sphere 102
 - Fundamental class 58
 - Homology algebra $H_*(\Omega S^n; \mathbb{k})$ 225, 234
 - Homology Lie algebra of a wedge of spheres 326
 - Lie model of a sphere 322
 - Lie model of a wedge of spheres 331
 - Loop space homology of a fat wedge 462
 - Loop space homology of a wedge of spheres 460
 - Model of the loop space ΩS^k 200
 - Rational homotopy groups of spheres 210
 - Sullivan model for a sphere 142
 - Whitehead product 178
- Spherical fibration 202
- Sullivan algebra 138
 - Pure Sullivan algebra 435
 - Relative Sullivan algebra 181, 262
- Sullivan model for a commutative cochain algebra 138, 141
 - Formality 156
 - Homotopy of maps 139, 148, 150, 153
 - Lifting lemma 148, 184, 186
 - Linear part of a morphism 152, 295
 - Linear part of the differential 141
 - Minimal Sullivan model 154, 186
- Sullivan model for a map
 - Fibre 181, 192
 - Model of a pullback fibration 204
 - Model of fibrations 195
 - Model of spherical fibrations 202
 - Model of the path space fibration 226
- Sullivan model for a space 138, 141
 - Contractible Sullivan model 139
 - Minimal Sullivan model 138, 146, 154
 - Model for a cell attachment 173
 - Model for a product 142
 - Model for a suspension 171
 - Model for a wedge 155
 - Model for an H -space 143
 - Models for smooth manifolds 213

- Quadratic part of the differential 175, 176
- The homotopy groups 171, 208
- Sullivan realization functor 247
- Sullivan representative for a map 154
- Symmetric spaces 162
- Symplectic manifolds 163
- Tensor algebra 268
- Tensor coalgebra 268
- The set of homotopy classes 151
- Toomer's invariant 366, 367
 - of a Sullivan algebra 381, 386, 391, 400
 - of a differential module 401
 - Rational Toomer invariant 370, 374, 386, 387, 432
- Topological group 35
 - Classifying space 36
 - Orbit space for a group action 35
- Topological monoid 28
 - Action of 28
 - Chain algebra on 88
- Topological space
 - H -space 143
 - k -space 1
 - n -cone 359
 - Adjunction space 3, 8, 328
 - Cell attachment 4
 - Cofibre 352
 - Conformal space 334, 388
 - Compact-open topology 1
 - CW complex 4
 - Filtered space 5
 - Formal space 156, 162, 163, 388
 - Homotopy fibre 30, 78
 - Join 21
 - Mapping cylinders 8
 - Mapping spaces 1
 - Moore path space 29
 - NDR-pair 15, 20
 - Product of 1, 7
 - Quotient of 1, 7
 - Reduced cone 352
 - Retract 3, 15
 - Smash product 21
 - Suspension 3, 7, 20, 359
 - Wedge of spaces 2, 7, 462
 - Well-based space 15
- The construction $A(K)$ 118
- The simplicial cochain algebra C_{PL} 124
- Tor 275, 465
 - Differential Tor 281
- Torus action 435
- Uniqueness of minimal models 152
- Universal enveloping algebra 285, 486
 - of a differential graded Lie algebra 296
 - Poincaré-Birkoff-Witt Theorem 286, 287
- Weak homotopy type 12, 14
- Whitehead lifting lemma 12
- Whitehead product 175, 176, 232, 293
- Whitehead-Serre Theorem 94
- Wordlength 140
 - in a tensor algebra 290
 - in Sullivan model 158, 262, 318



听雨尘心@含藏识

免费电子书下载

<http://realking1980.bokee.com>